

US00D498049S

(12) **United States Design Patent** (10) **Patent No.:** **US D498,049 S**
Perella et al. (45) **Date of Patent:** **** *Nov. 9, 2004**

(54) **STORAGE DEVICE**

(75) Inventors: **Daniel Perella**, Hudson, OH (US);
Anthony DeCarlo, Bay Village, OH (US); **Vincent Thomson**, Avon Lake, OH (US)

(73) Assignee: **Ideastream Consumer Products LLC**, Parma, OH (US)

(*) Notice: This patent is subject to a terminal disclaimer.

(**) Term: **14 Years**

(21) Appl. No.: **29/181,737**

(22) Filed: **May 16, 2003**

(51) **LOC (7) Cl.** **03-01**

(52) **U.S. Cl.** **D3/273; D3/276**

(58) **Field of Search** **D3/272, 273, 276, D3/281, 282, 291, 294, 900, 321; 190/900, 100, 124, 127**

(56) **References Cited**

U.S. PATENT DOCUMENTS

D129,108 S	*	8/1941	Sprague	D3/268
D247,993 S	*	5/1978	Calzone, III	D3/204
4,509,622 A	*	4/1985	Morszeck	190/119
D285,626 S	*	9/1986	Yen	D3/292
4,669,587 A	*	6/1987	Zitt	190/109
D378,164 S	*	2/1997	Lee	D3/276
D414,037 S	*	9/1999	Akaike et al.	D3/276
D415,614 S	*	10/1999	Akaike et al.	D3/276
D439,044 S	*	3/2001	Cheng	D3/276

* cited by examiner

Primary Examiner—Philip S. Hyder

(74) *Attorney, Agent, or Firm*—Pillsbury Winthrop LLC

(57) **CLAIM**

The ornamental design for a storage device, as shown and described.

DESCRIPTION

FIG. 1 is a perspective view of a storage device embodying our new design;

FIG. 2 is a left side profile view of the storage device of FIG. 1;

FIG. 3 is a right side profile view of the storage device of FIG. 1;

FIG. 4 is a front elevational view of the storage device of FIG. 1;

FIG. 5 is a rear elevational view of the storage device of FIG. 1;

FIG. 6 is a top plan view of the storage device of FIG. 1;

FIG. 7 is a bottom plan view of the storage device of FIG. 1;

FIG. 8 is a perspective view of an alternative embodiment of a storage device embodying our new design, with unclaimed portions of the storage device shown in broken lines;

FIG. 9 is a left side profile view of the storage device of FIG. 8;

FIG. 10 is a right side profile view of the storage device of FIG. 8;

FIG. 11 is a front elevational view of the storage device of FIG. 8;

FIG. 12 is a rear elevational view of the storage device of FIG. 8;

FIG. 13 is a top plan view of the storage device of FIG. 8; and,

FIG. 14 is a bottom plan view of the storage device of FIG. 8.

The broken line portions of the disclosure are for illustrative purposes only and form no part of the claimed design.

1 Claim, 12 Drawing Sheets

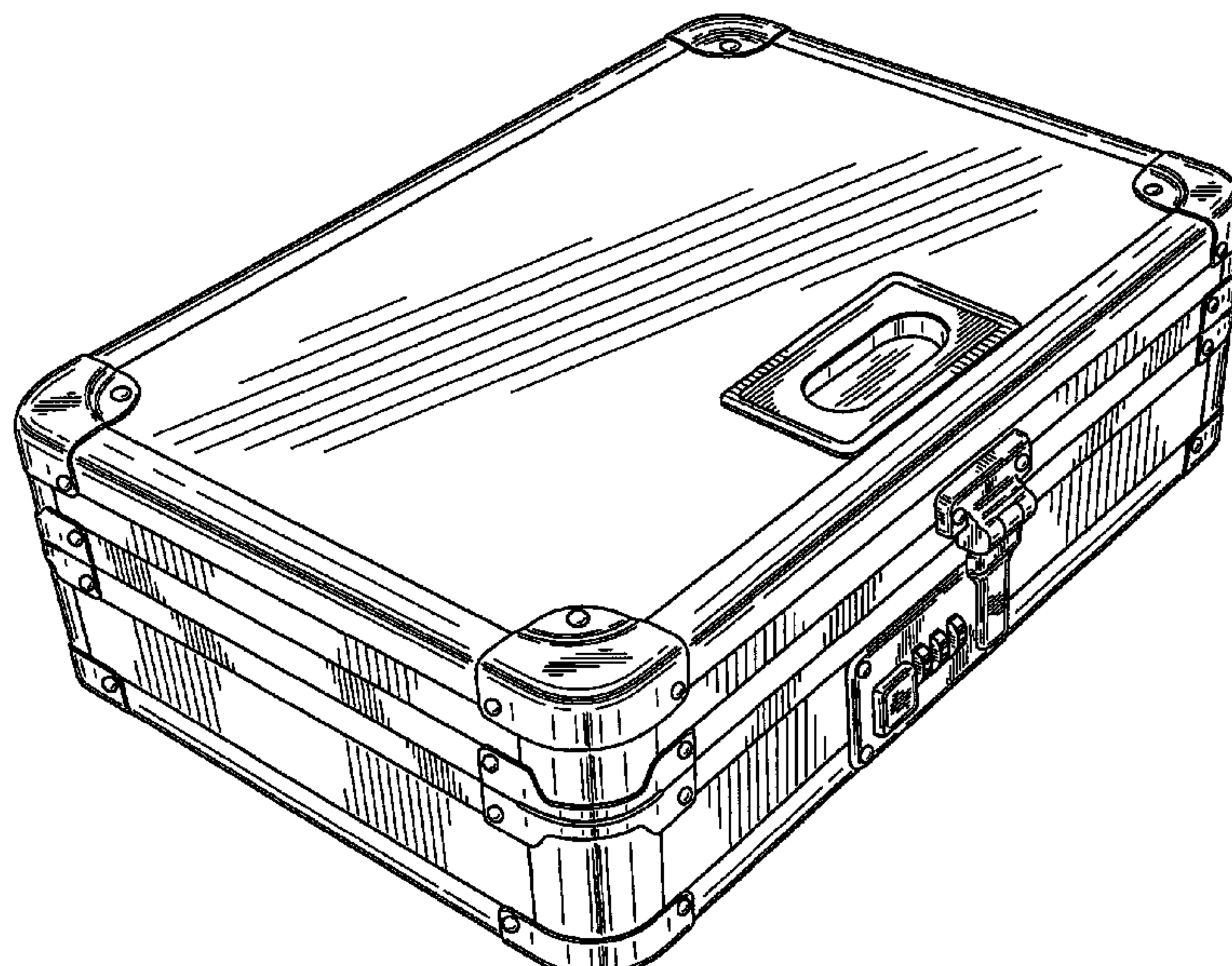

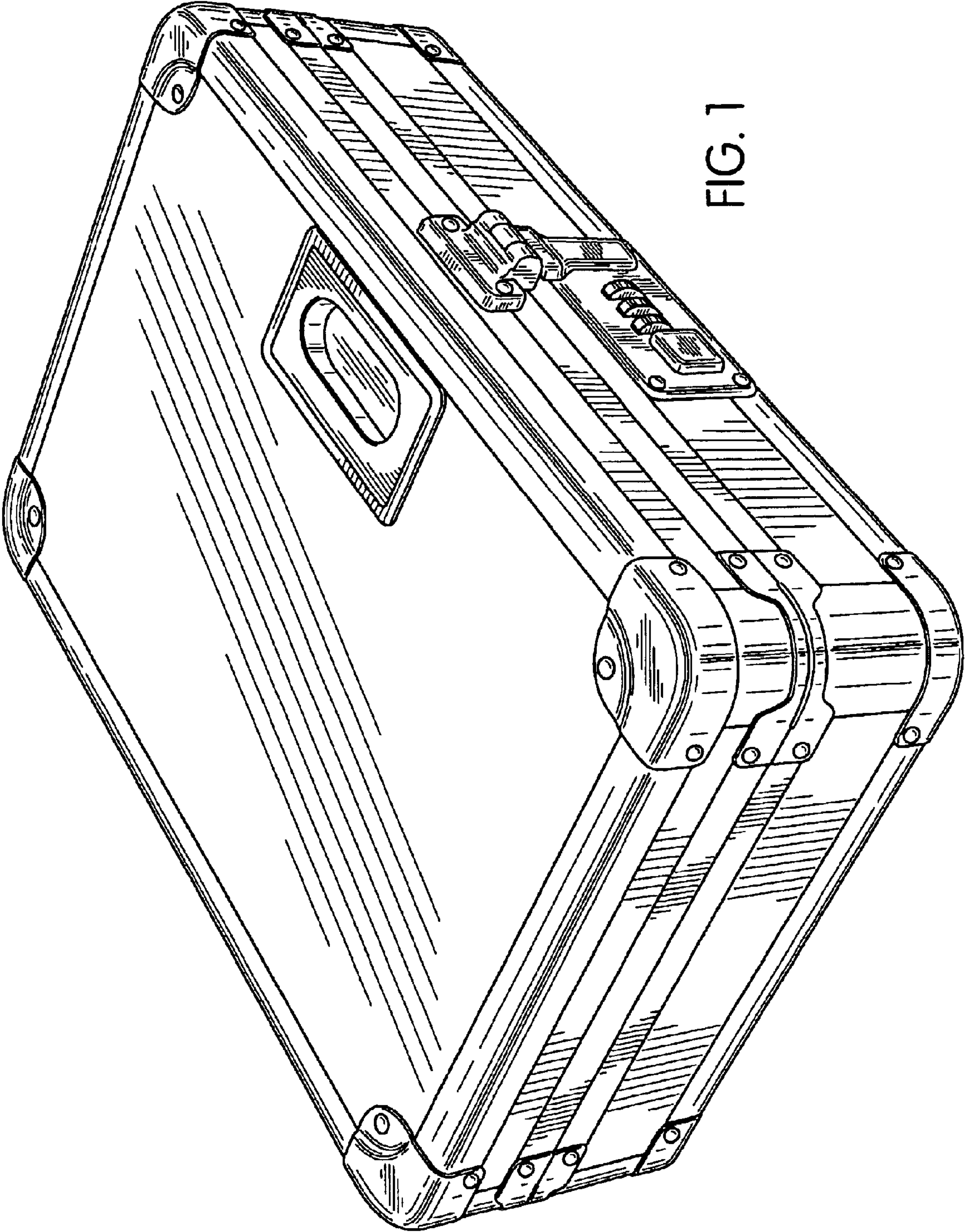

FIG. 1

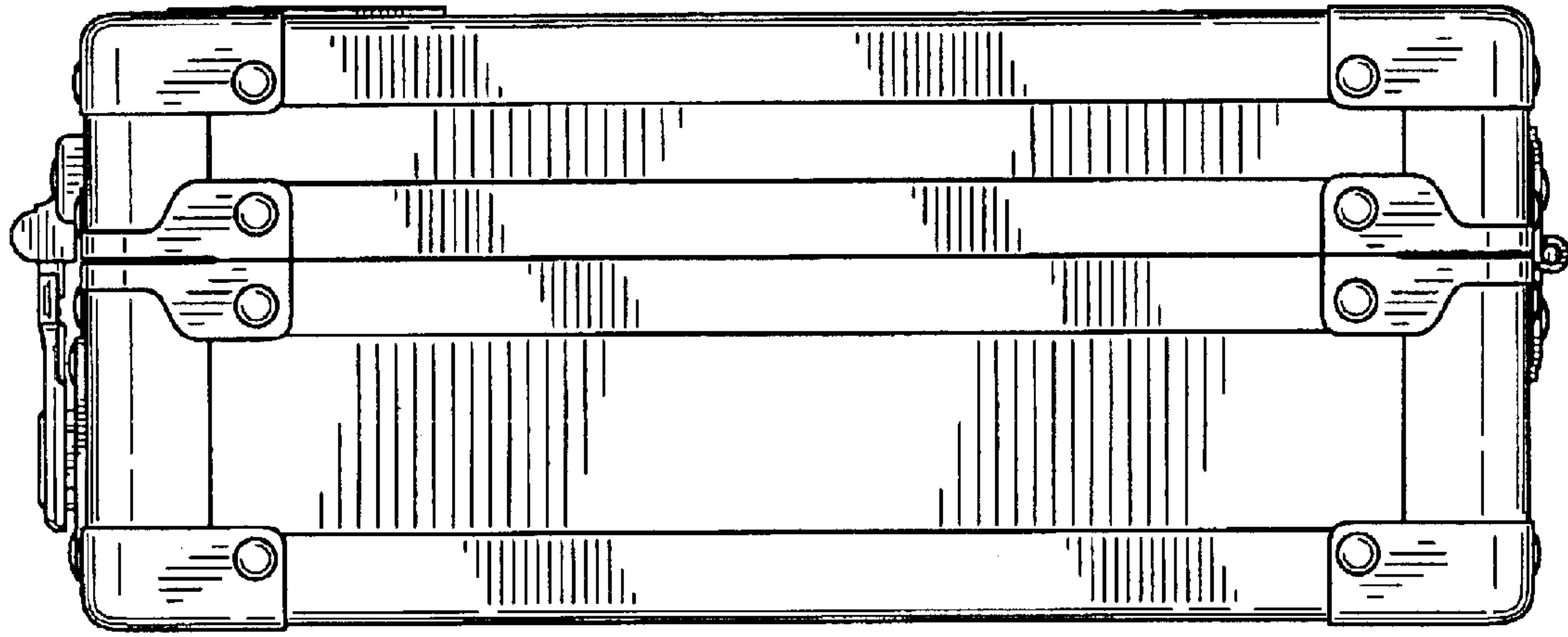

FIG. 2

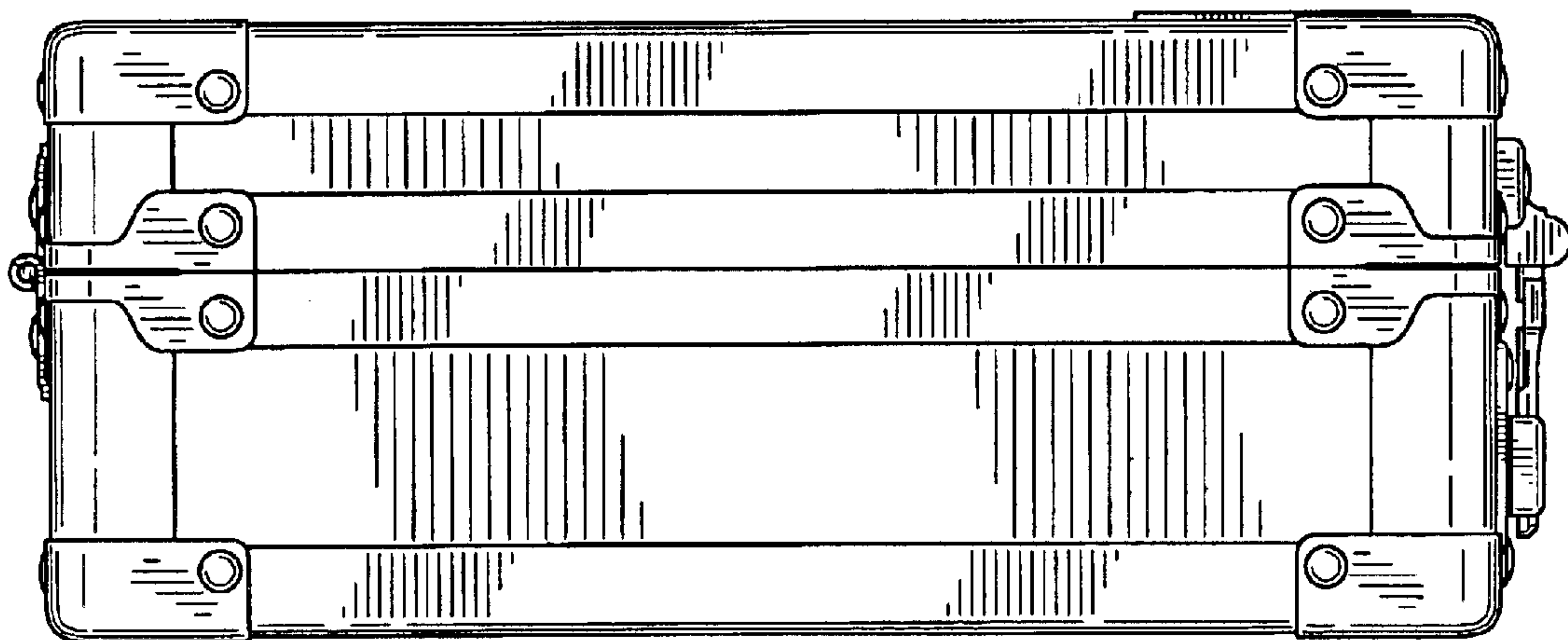

FIG. 3

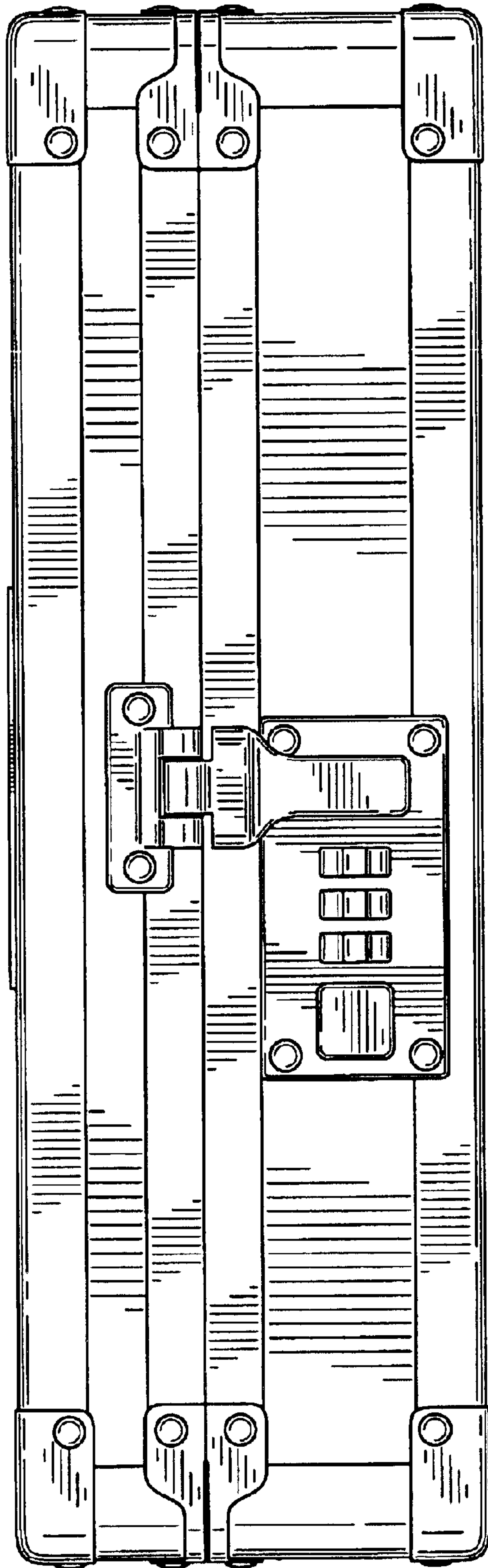

FIG. 4

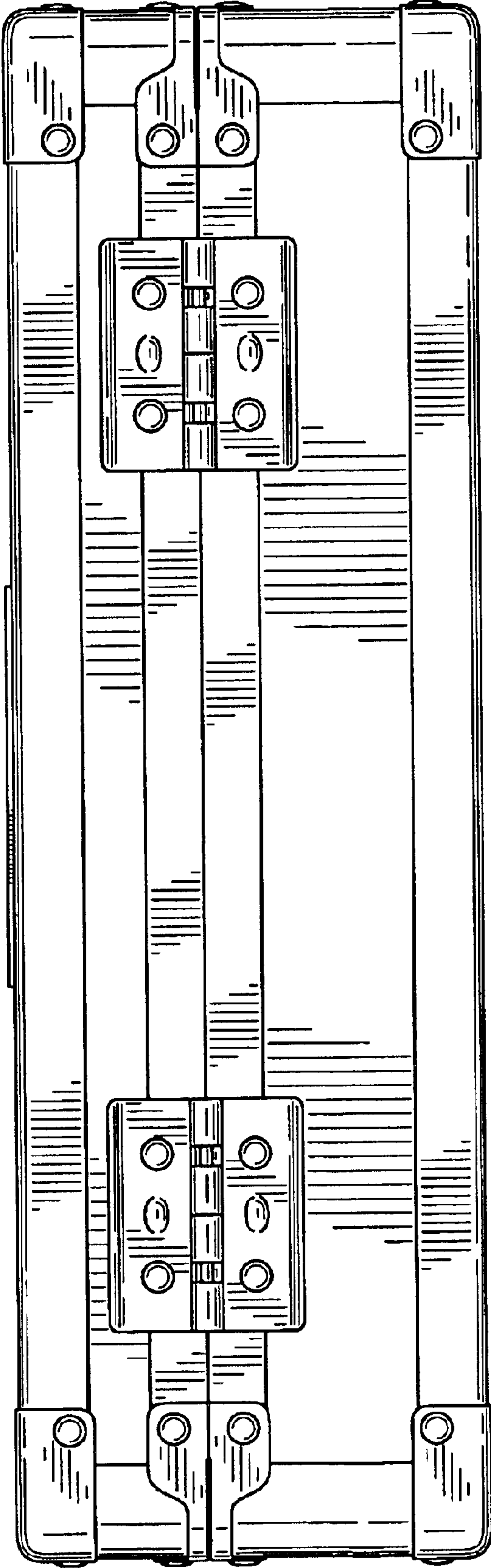

FIG. 5

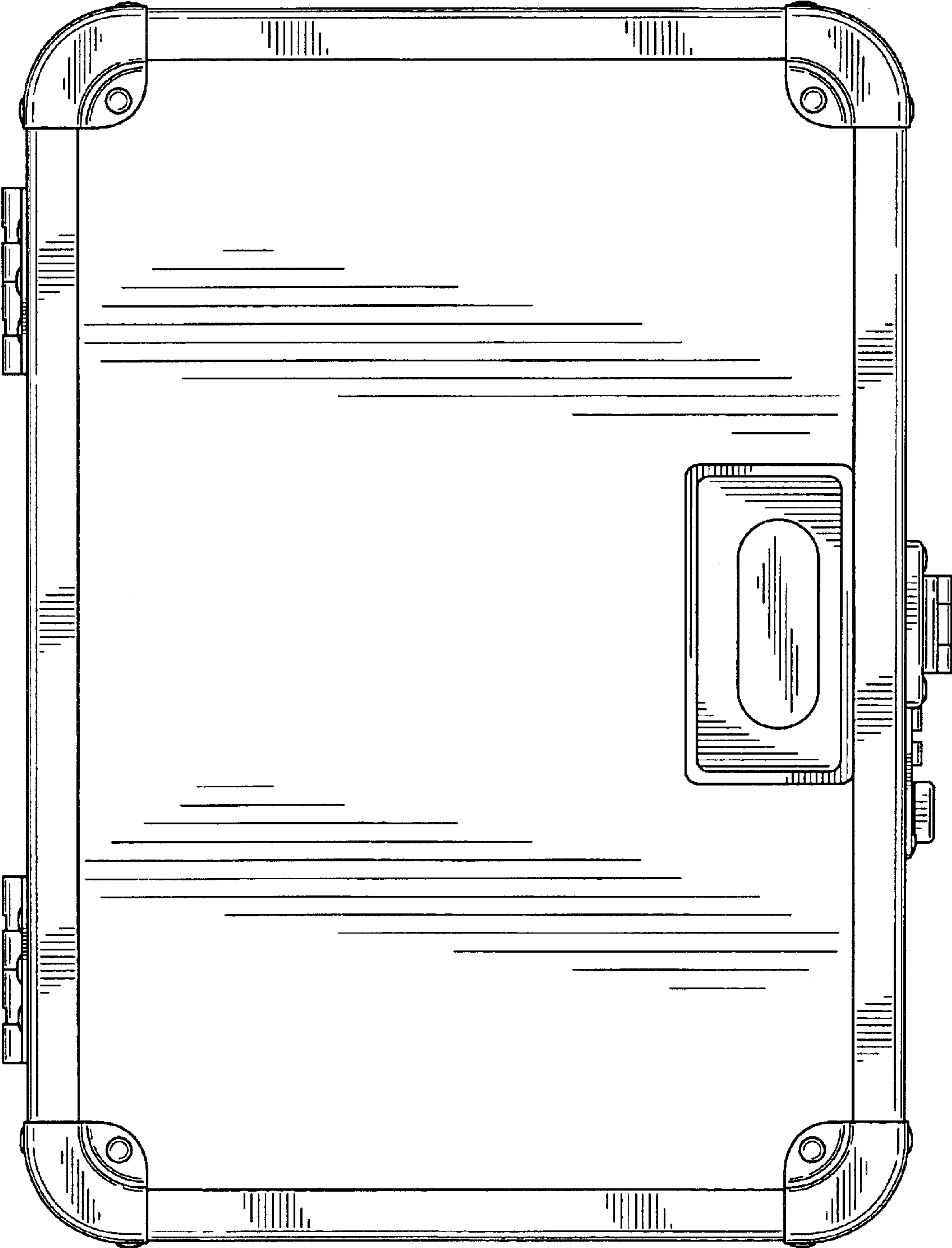
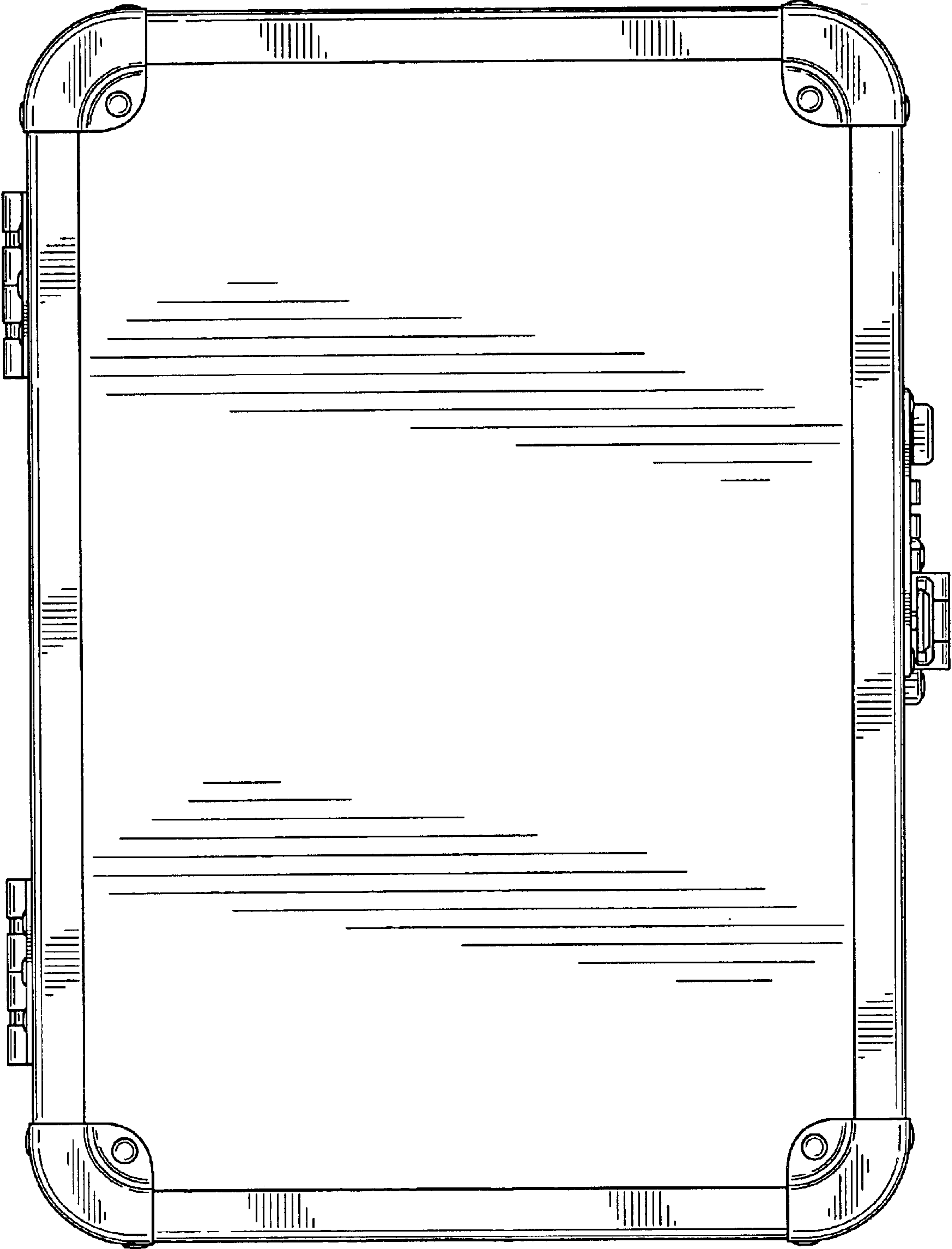

FIG. 6

FIG. 7



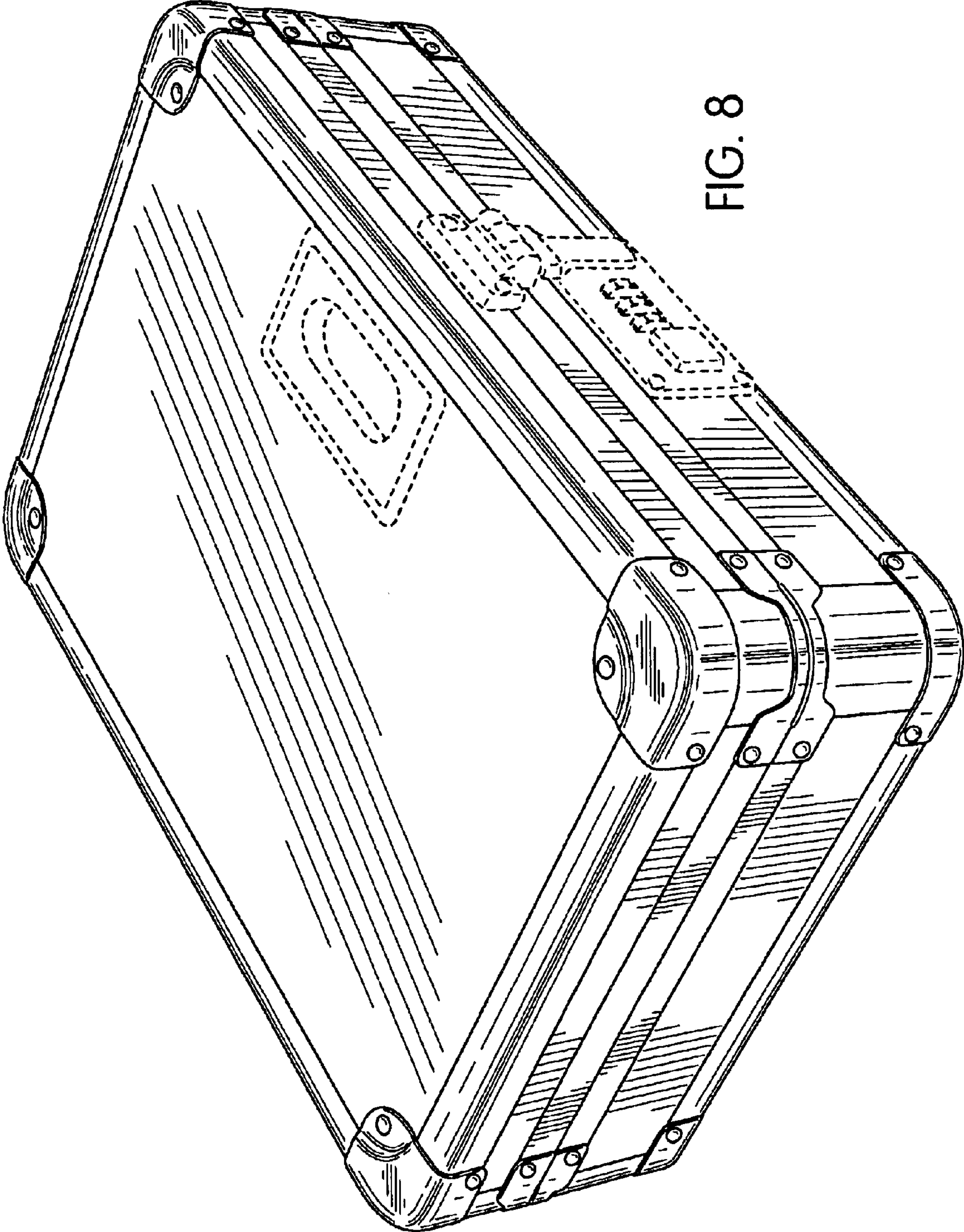

FIG. 8

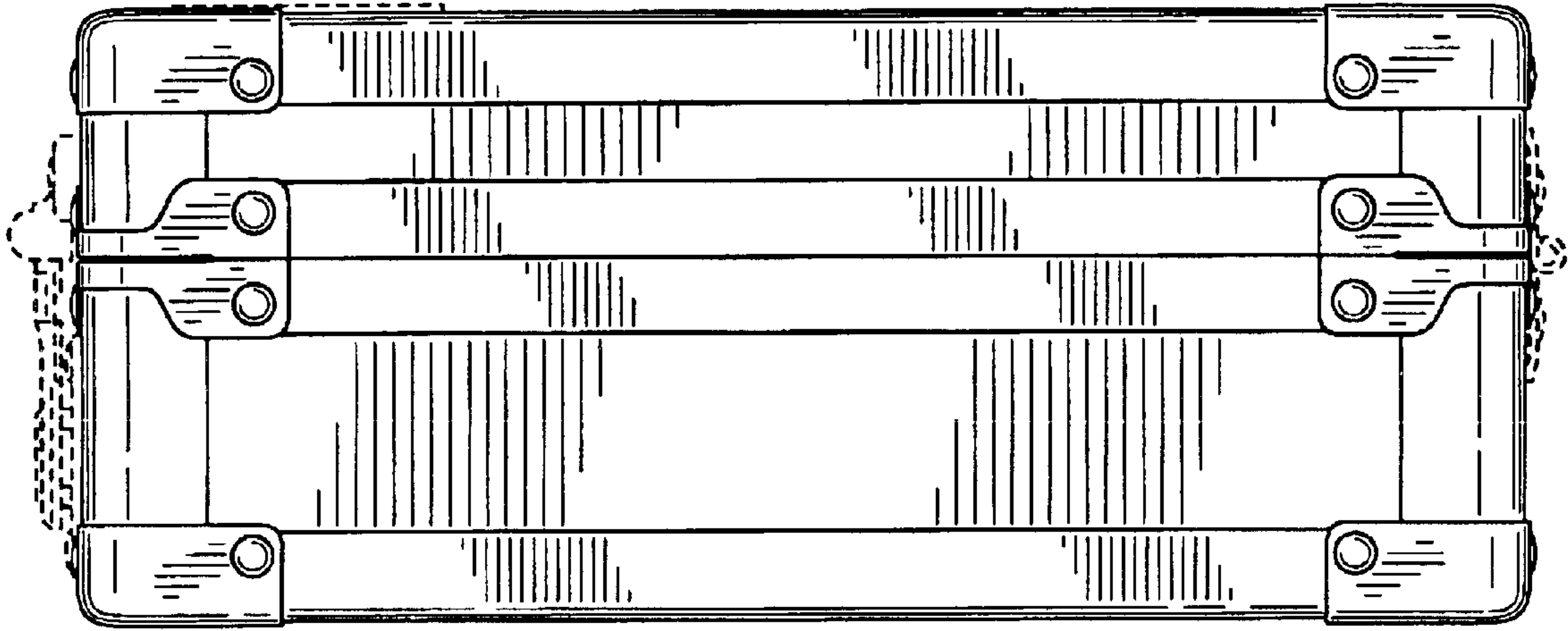

FIG. 9

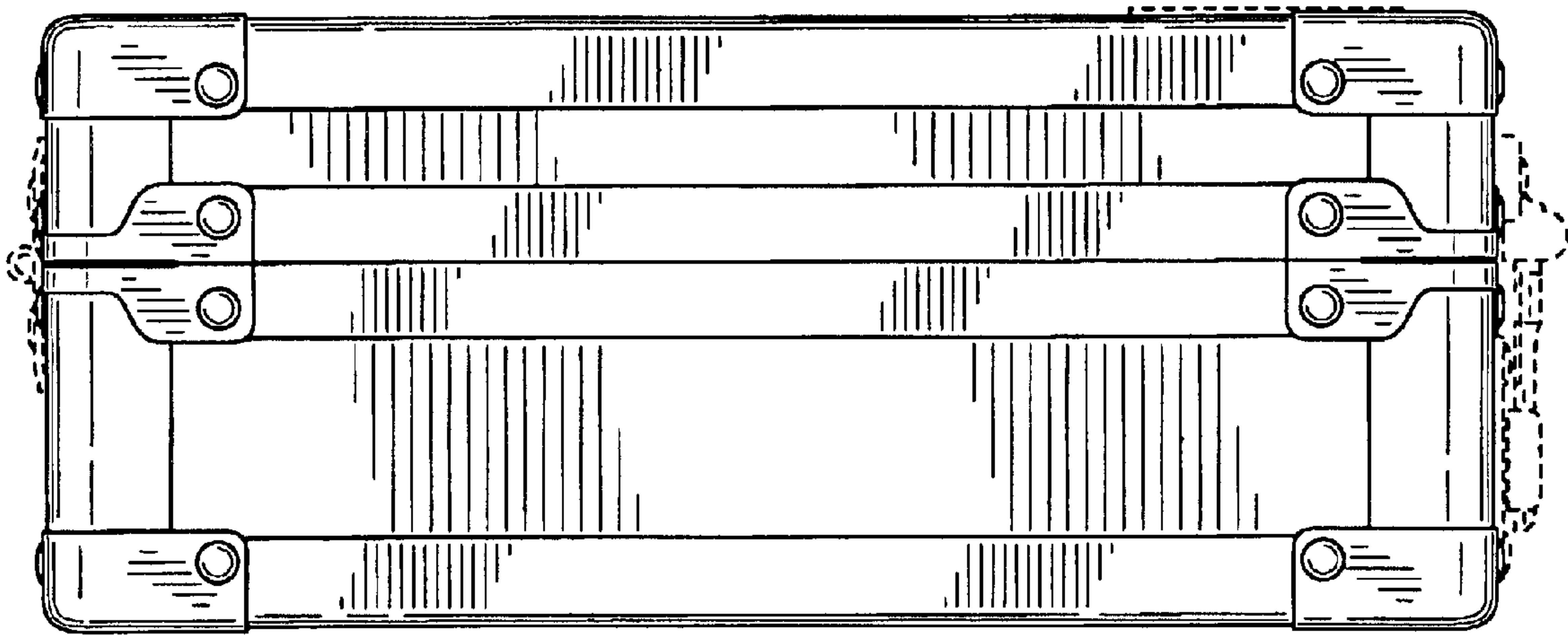

FIG. 10

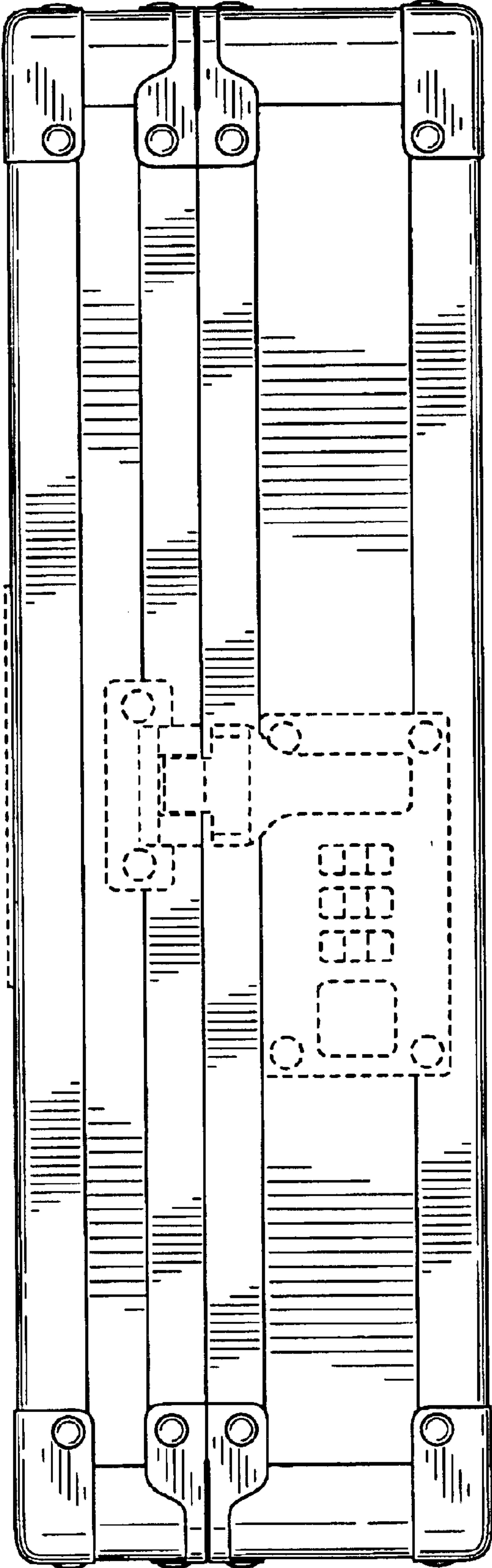

FIG. 11

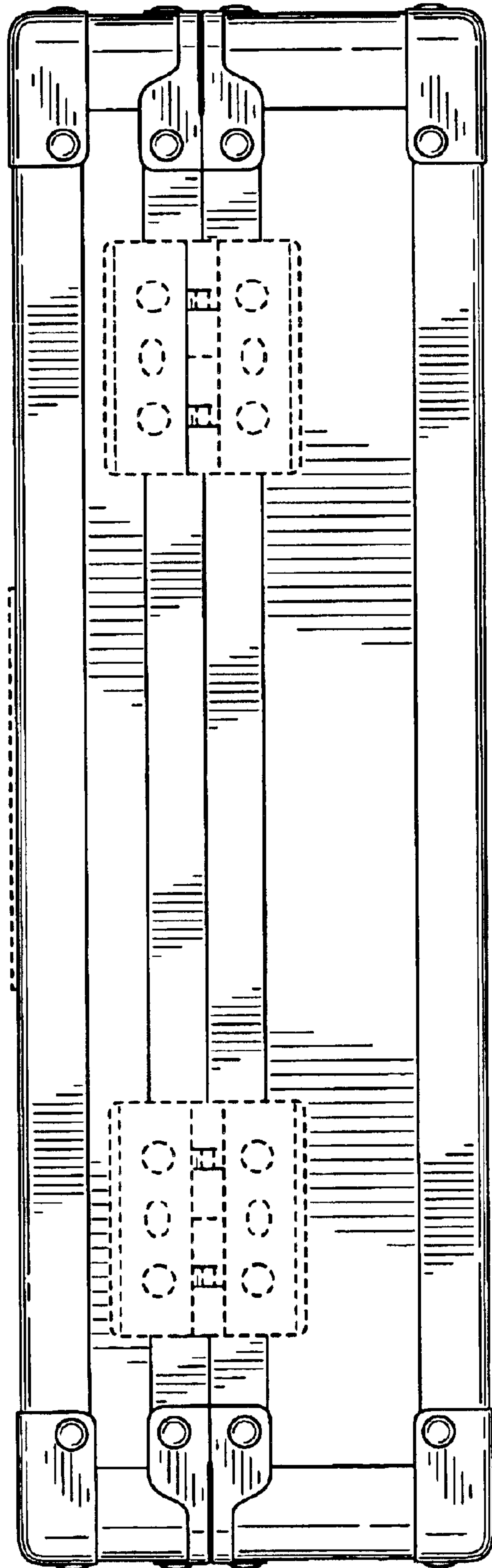
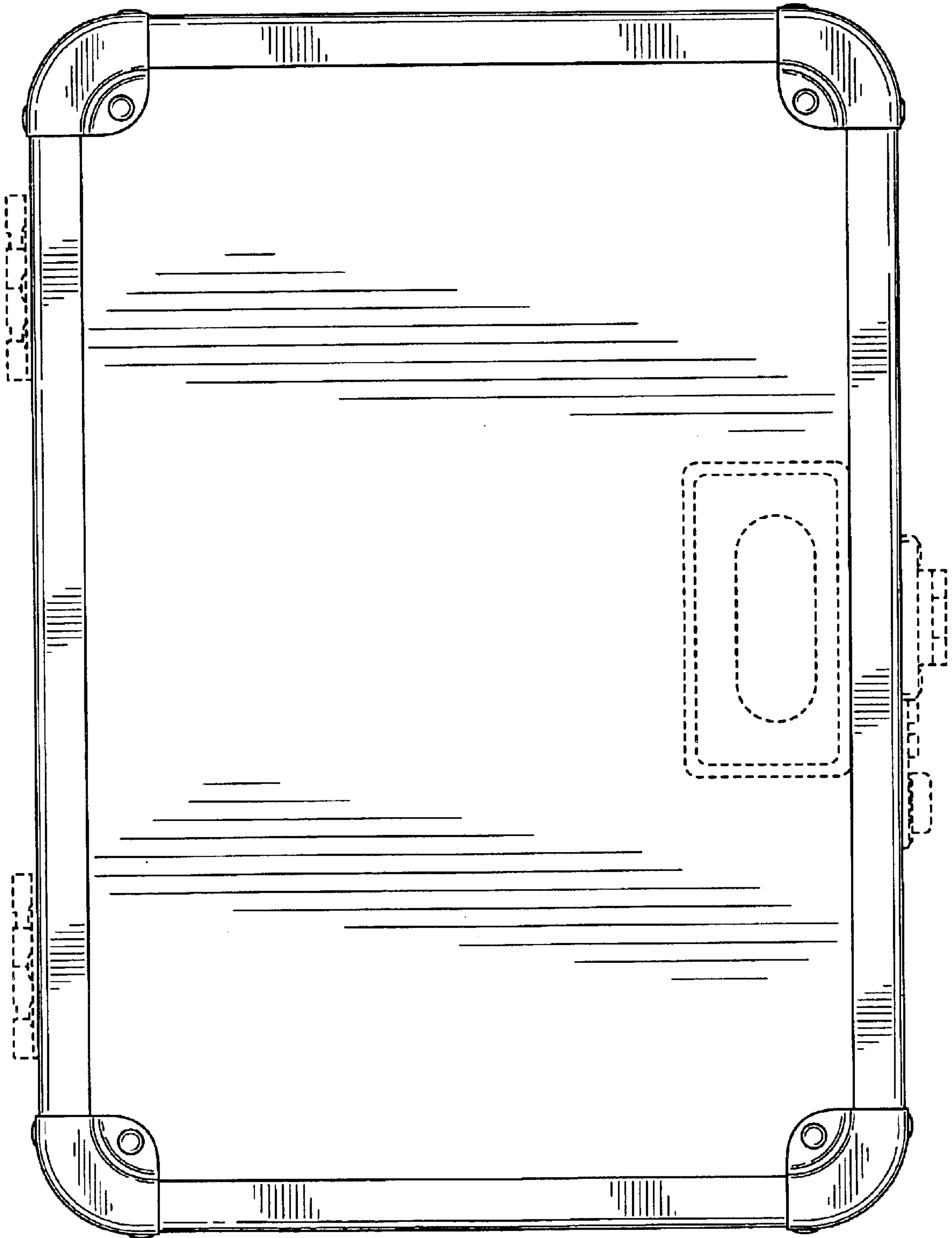

FIG. 12

FIG. 13



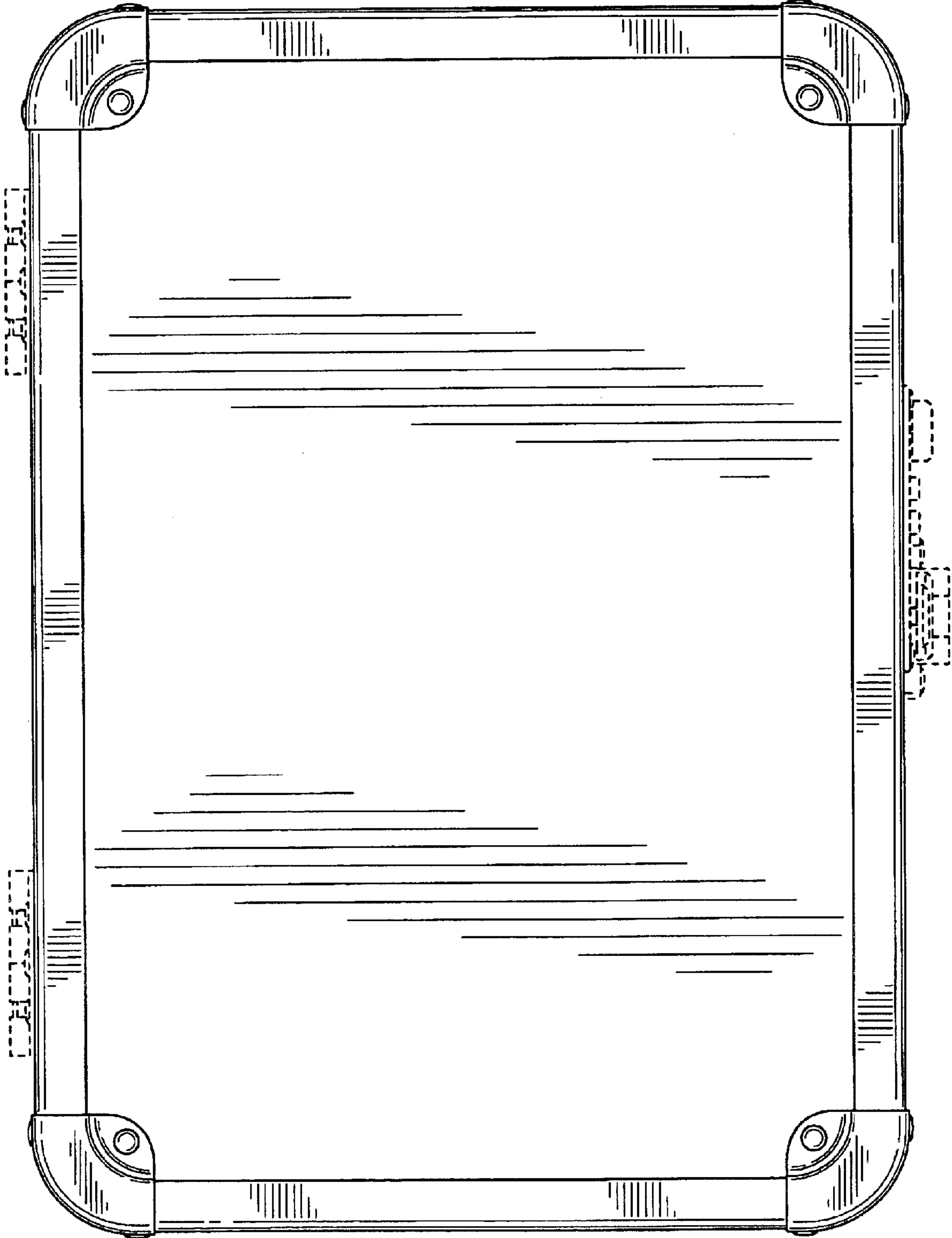

FIG. 14