

US00D497958S1

(12) **United States Design Patent**
Campbell

(10) **Patent No.:** **US D497,958 S**

(45) **Date of Patent:** **** Nov. 2, 2004**

(54) **CHILD'S STEERABLE RIDING TOY WITH BRAKES AND PIVOTING, SPRING-BIASED, HAND-OPERATED PROPELLING DEVICE**

(76) **Inventor:** **Glenwood P. Campbell**, 810 Herbert Dr., Kinston, NC (US) 28501-4608

(**) **Term:** **14 Years**

(21) **Appl. No.:** **29/188,632**

(22) **Filed:** **Aug. 22, 2003**

(51) **LOC (7) Cl.** **21-01**

(52) **U.S. Cl.** **D21/426; D21/435**

(58) **Field of Search** D21/419-435,
D21/533-534, 548-551, 561-563; D12/87-88;
446/160, 286, 447, 428, 456, 465, 470;
280/1.13, 87.01, 87.021, 828, 87.041

(56) **References Cited**

U.S. PATENT DOCUMENTS

1,112,214 A	*	9/1914	Johnson	280/87.021
1,212,530 A	*	1/1917	McKnight	280/87.021
1,313,470 A	*	8/1919	Discher	280/87.01
D55,054 S	*	5/1920	Keeney	D21/435
D60,072 S	*	12/1921	Tully	D21/435
D170,160 S		8/1953	Minozzi		
3,332,700 A	*	7/1967	Walker	D21/423
D229,079 S	*	11/1973	Boyle	D21/435

3,795,409 A	3/1974	Cudmore
4,133,548 A	1/1979	Smith
4,134,600 A	1/1979	McDonald et al.
D252,759 S	8/1979	Medor
D253,062 S	10/1979	Kupka
4,230,331 A	10/1980	Johnson
D278,162 S	3/1985	Carmagnola et al.
5,163,696 A	11/1992	Pesco, Sr.
5,775,452 A	7/1998	Patmont

* cited by examiner

Primary Examiner—Raphael Barkai

(74) *Attorney, Agent, or Firm*—Donald R. Schoonover

(57) **CLAIM**

I claim the ornamental design for a child's steerable riding toy with brakes and pivoting, spring-biased, hand-operated propelling device, as shown and described.

DESCRIPTION

FIG. 1 is a perspective view of a child's steerable riding toy with brakes and pivoting, spring-biased, hand-operated propelling device showing my new design; FIG. 2 is a side elevational view thereof; FIG. 3 is a top plan view thereof; FIG. 4 is a front elevational view thereof; FIG. 5 is a rear elevational view thereof; and, FIG. 6 is a bottom plan view thereof.

1 Claim, 3 Drawing Sheets

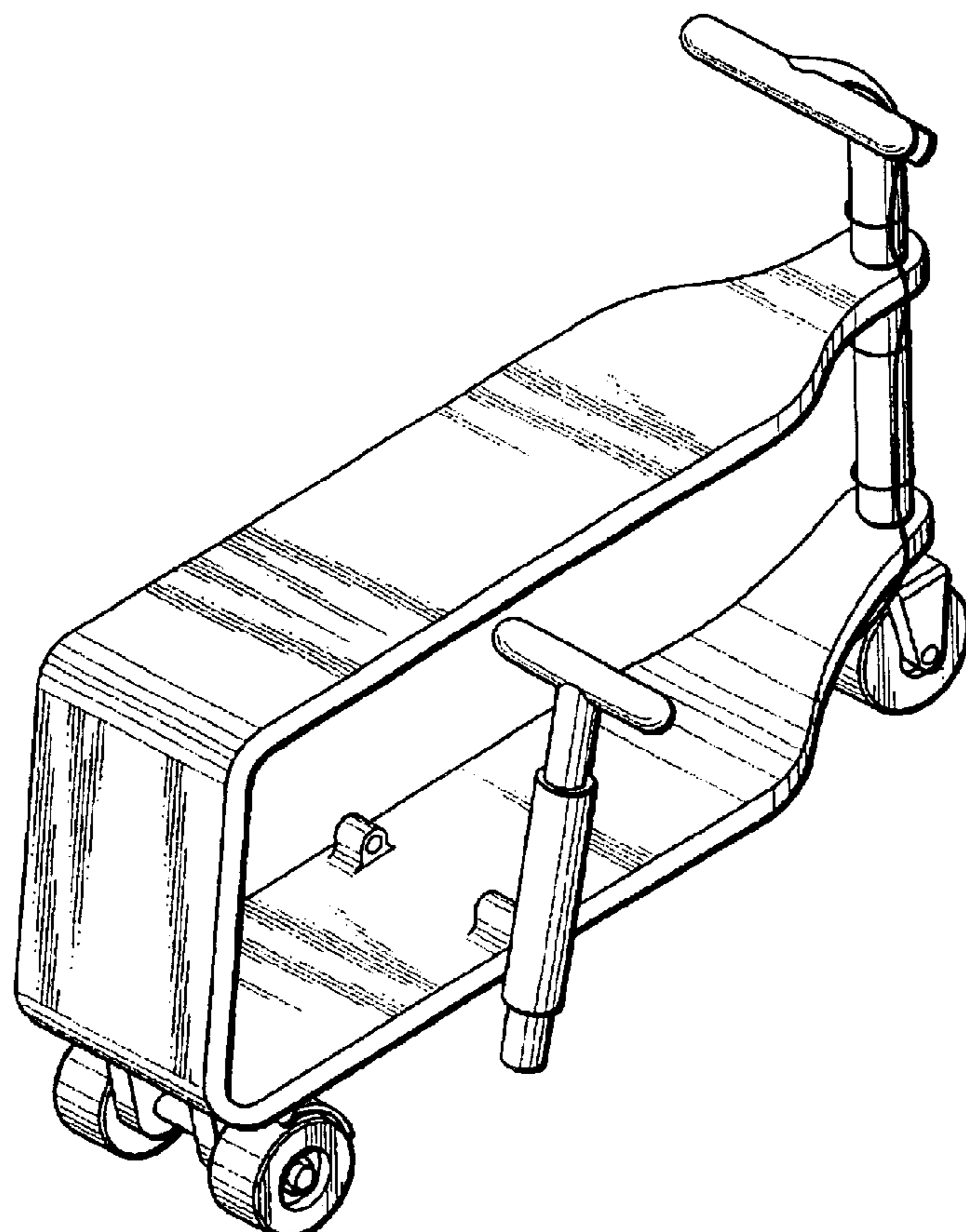

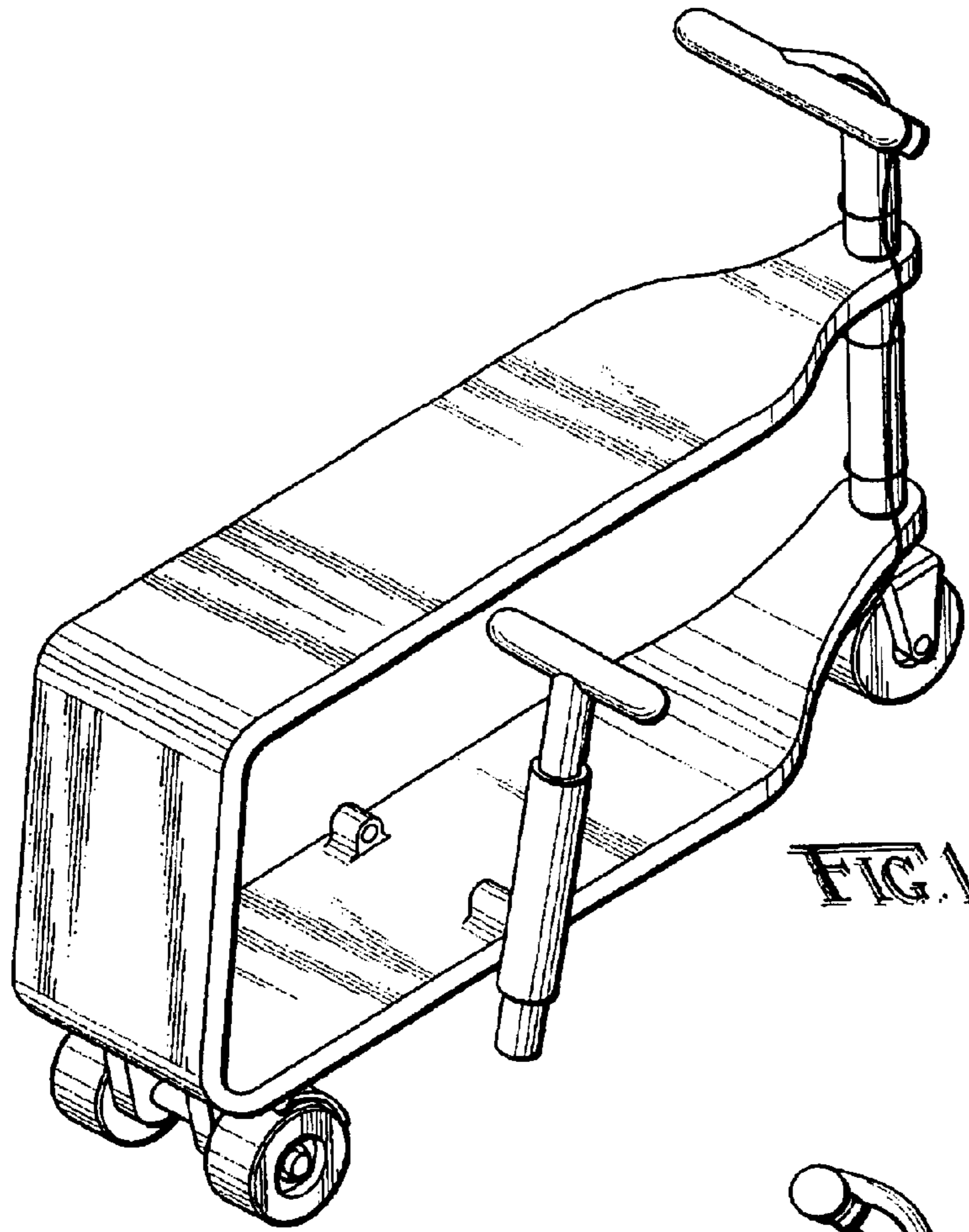

FIG. 1

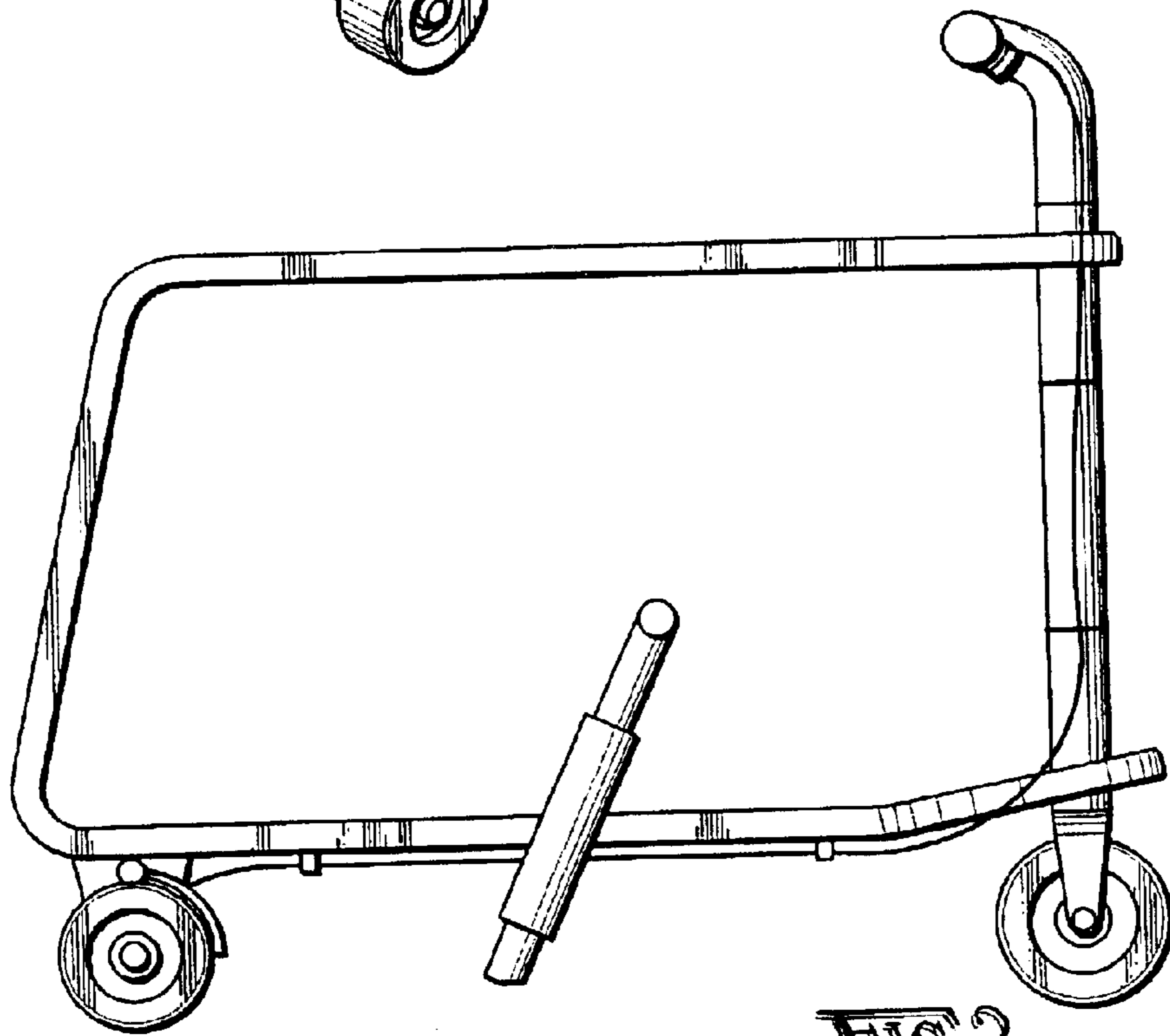

FIG. 2

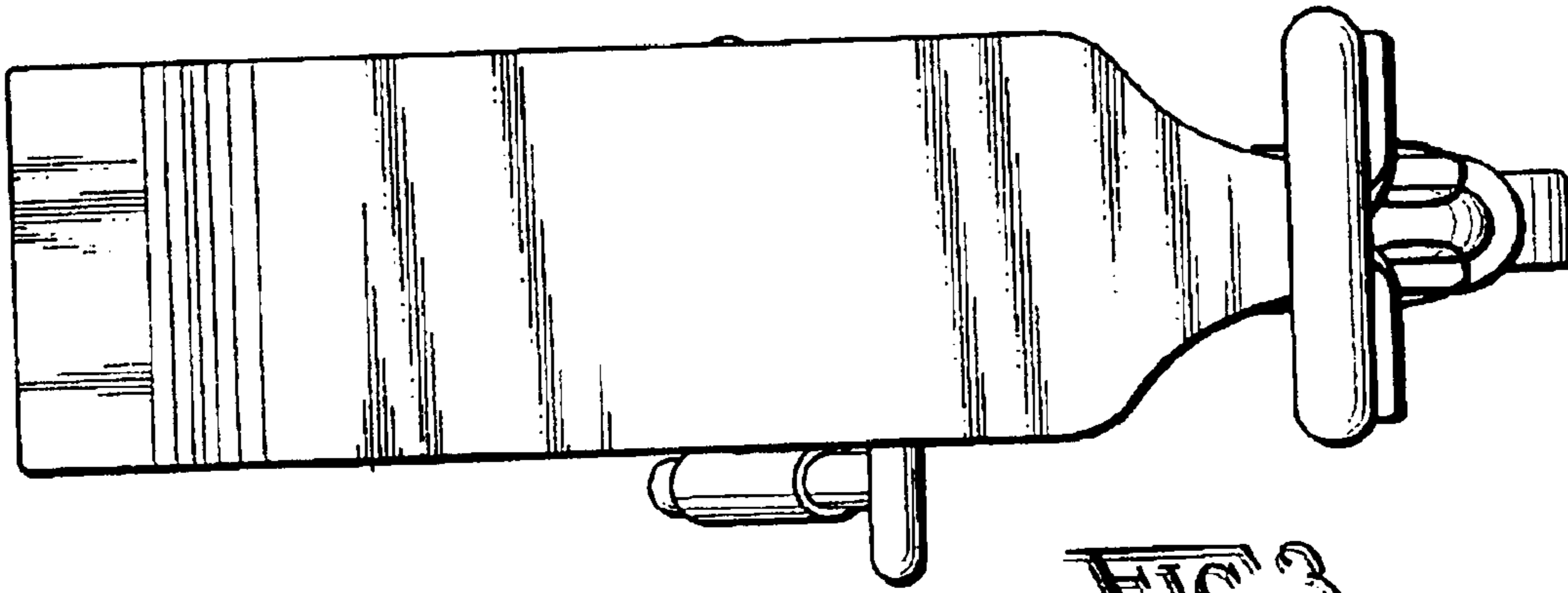

FIG. 3

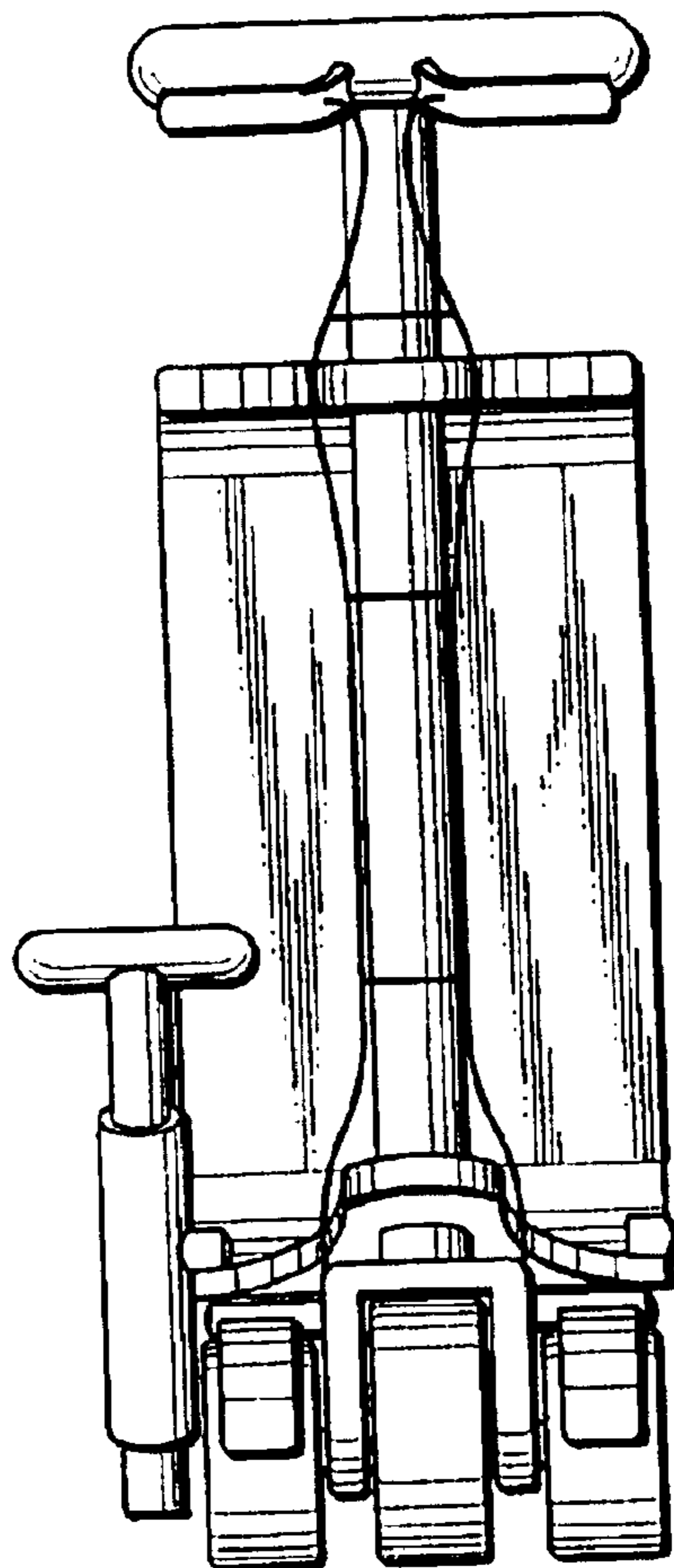

FIG. 4

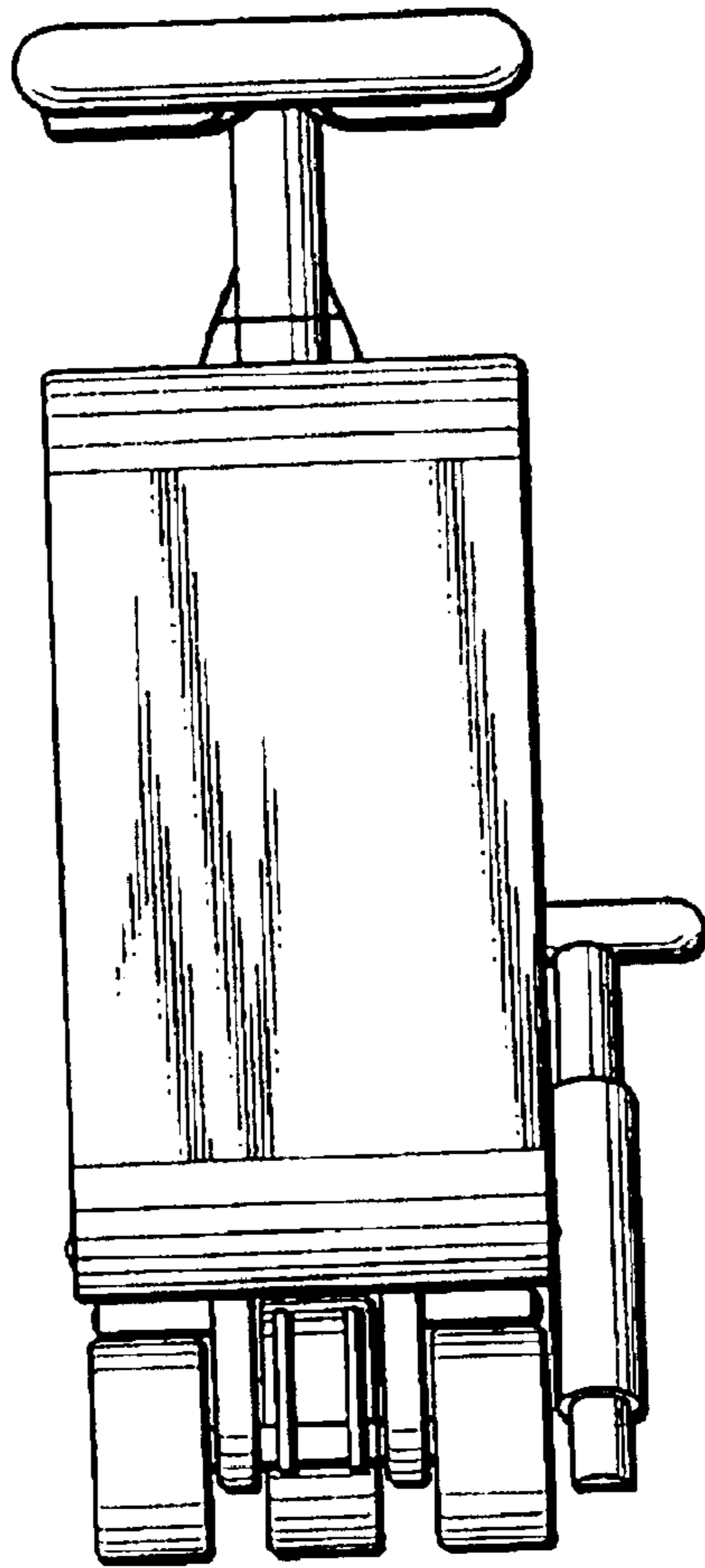

FIG. 5

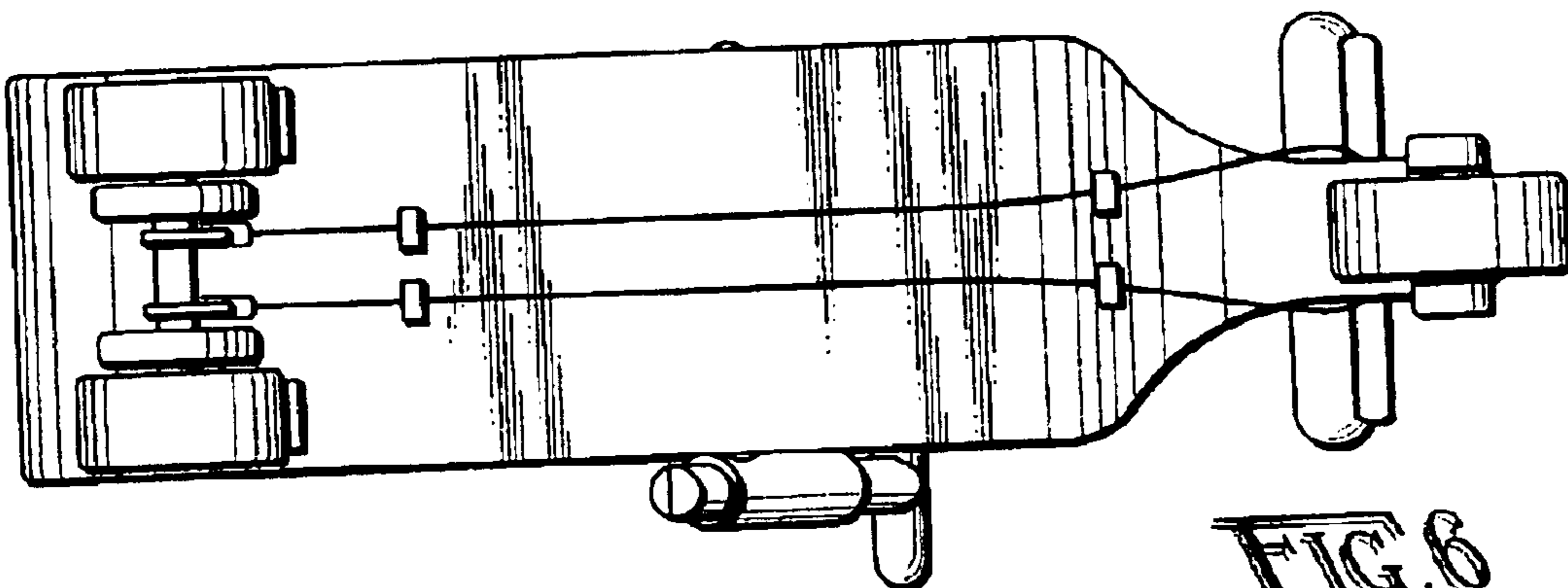

FIG. 6