

US00D497944S1

(12) **United States Design Patent** (10) **Patent No.:** **US D497,944 S**
Amemiya et al. (45) **Date of Patent:** **** Nov. 2, 2004**

(54) **INK-JET PRINTER**

(75) Inventors: **Kanae Amemiya**, Tokyo (JP); **Masaaki Kabumoto**, Chiba (JP); **Goro Katsuyama**, Kanagawa (JP); **Ryota Yano**, Kanagawa (JP); **Osamu Miki**, Kanagawa (JP)

5,666,146 A 9/1997 Mochizuki et al.
 5,788,388 A 8/1998 Cowger et al.
 5,860,363 A 1/1999 Childers et al.
 6,264,314 B1 7/2001 Mochizuki et al.
 D448,796 S * 10/2001 Clark et al. D18/55
 D475,083 S * 5/2003 Kusanagi D18/50
 D484,185 S * 12/2003 Cercos et al. D18/55

(73) Assignee: **Ricoh Company, Ltd.**, Tokyo (JP)

(**) Term: **14 Years**

(21) Appl. No.: **29/180,514**

(22) Filed: **Apr. 25, 2003**

(30) **Foreign Application Priority Data**

Oct. 31, 2002 (JP) 2002-029781

(51) **LOC (7) Cl.** **14-02**

(52) **U.S. Cl.** **D18/55**

(58) **Field of Search** D18/19, 36-39,
 D18/50, 54-54.1, 55; D14/420-426, 428,
 462-470; 400/691-694, 613, 613.1-613.4,
 690.1-690.4

(56) **References Cited**

U.S. PATENT DOCUMENTS

D296,903 S * 7/1988 Ooie D18/36
 D322,451 S * 12/1991 McClelland et al. D18/55
 D340,944 S * 11/1993 Ishizawa D18/50
 D352,732 S * 11/1994 Dubson et al. D18/55
 D369,181 S * 4/1996 Kobayashi D18/55
 D376,814 S * 12/1996 Asai et al. D18/50

FOREIGN PATENT DOCUMENTS

JP 10-202900 1/1997
 JP 10-202901 1/1997
 JP 3024260 3/2000

* cited by examiner

Primary Examiner—Cathy Anne MacCormac

(74) *Attorney, Agent, or Firm*—Dickstein Shapiro Morin & Oshinsky LLP

(57) **CLAIM**

The ornamental design for an ink-jet printer, as shown and described.

DESCRIPTION

FIG. 1 is a front elevation of an ink-jet printer according to the present invention;
 FIG. 2 is a rear elevation thereof;
 FIG. 3 is a top plan view thereof;
 FIG. 4 is a bottom plan view thereof;
 FIG. 5 is a right side elevation thereof;
 FIG. 6 is a left side elevation thereof; and,
 FIG. 7 is a top, front and right side perspective view thereof.

1 Claim, 3 Drawing Sheets

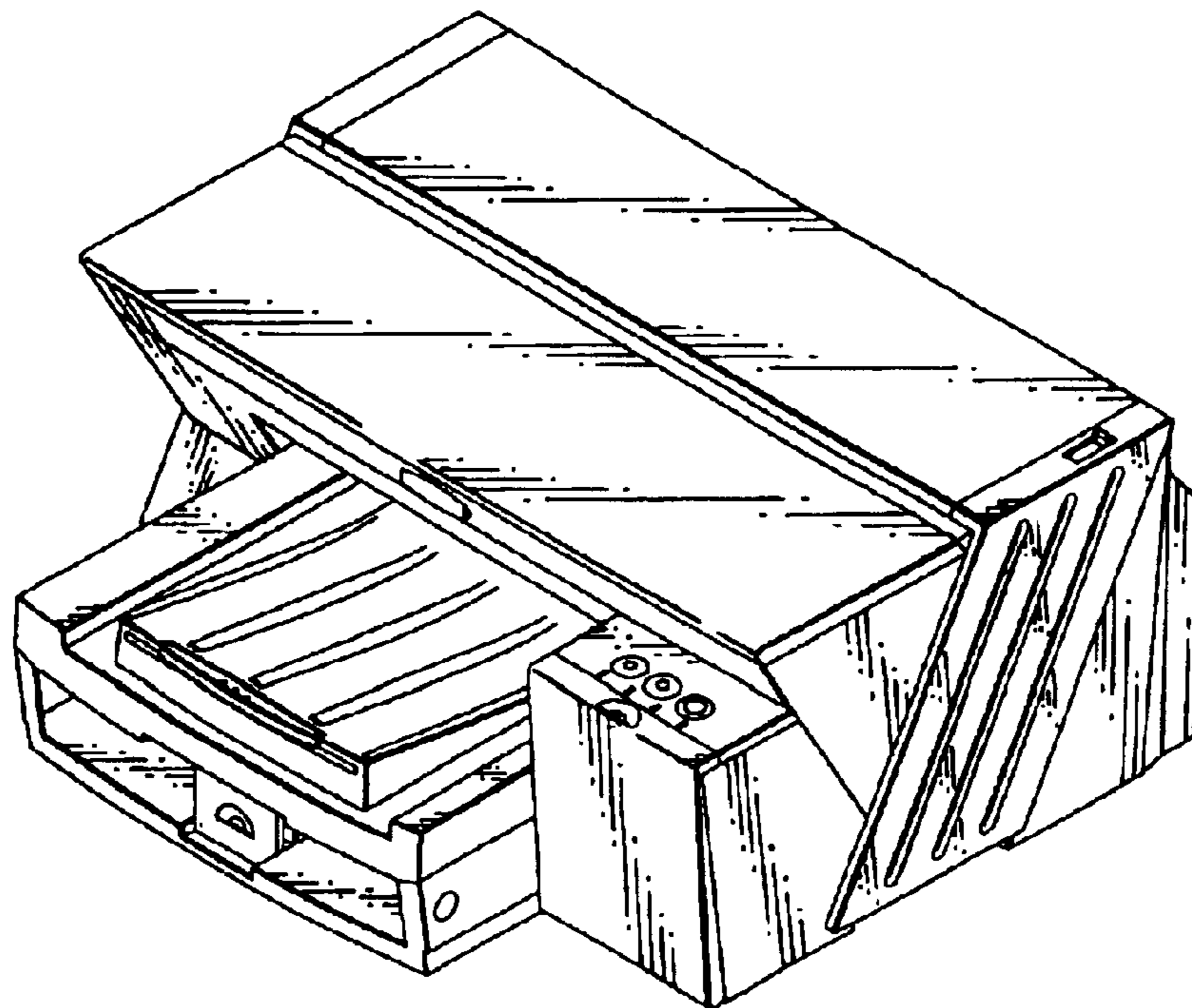

FIG. 1

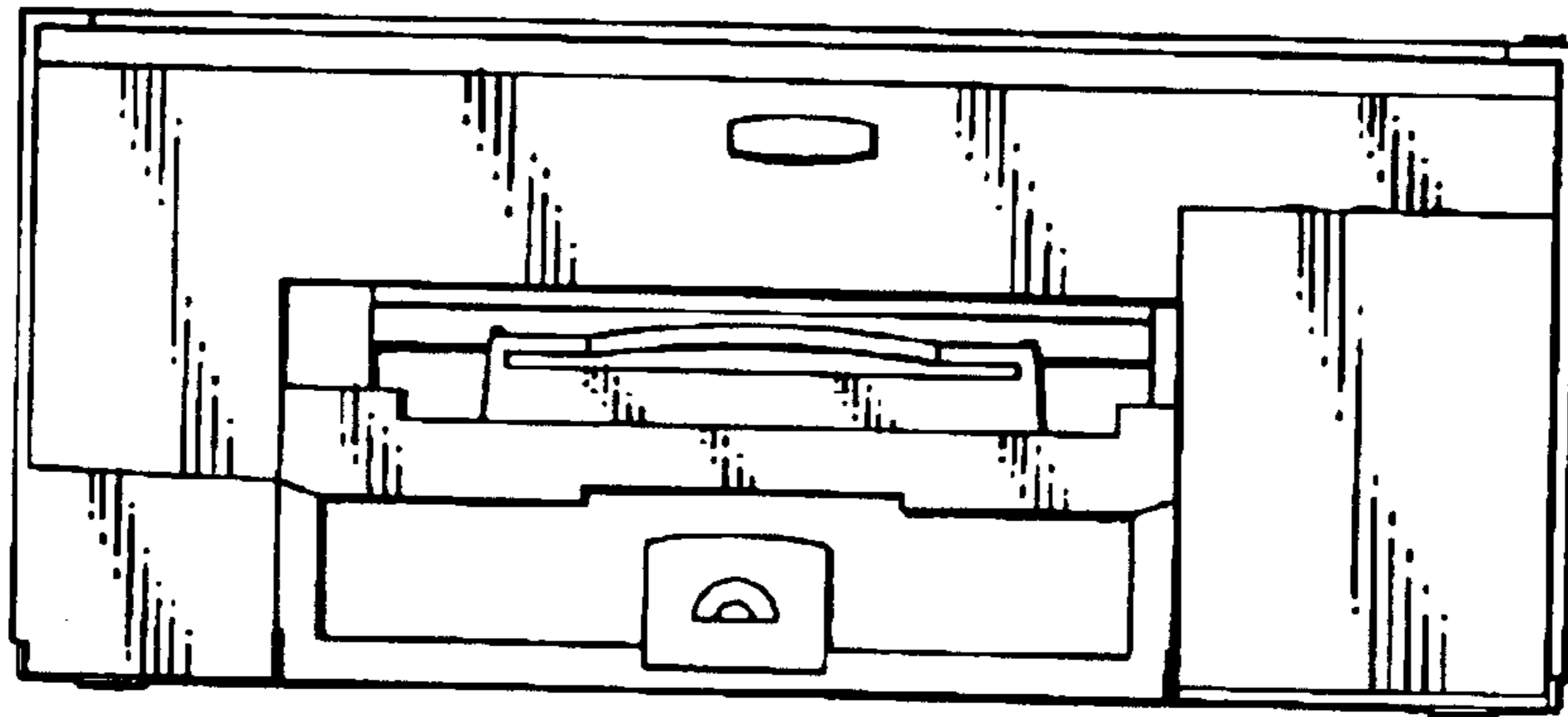

FIG. 2

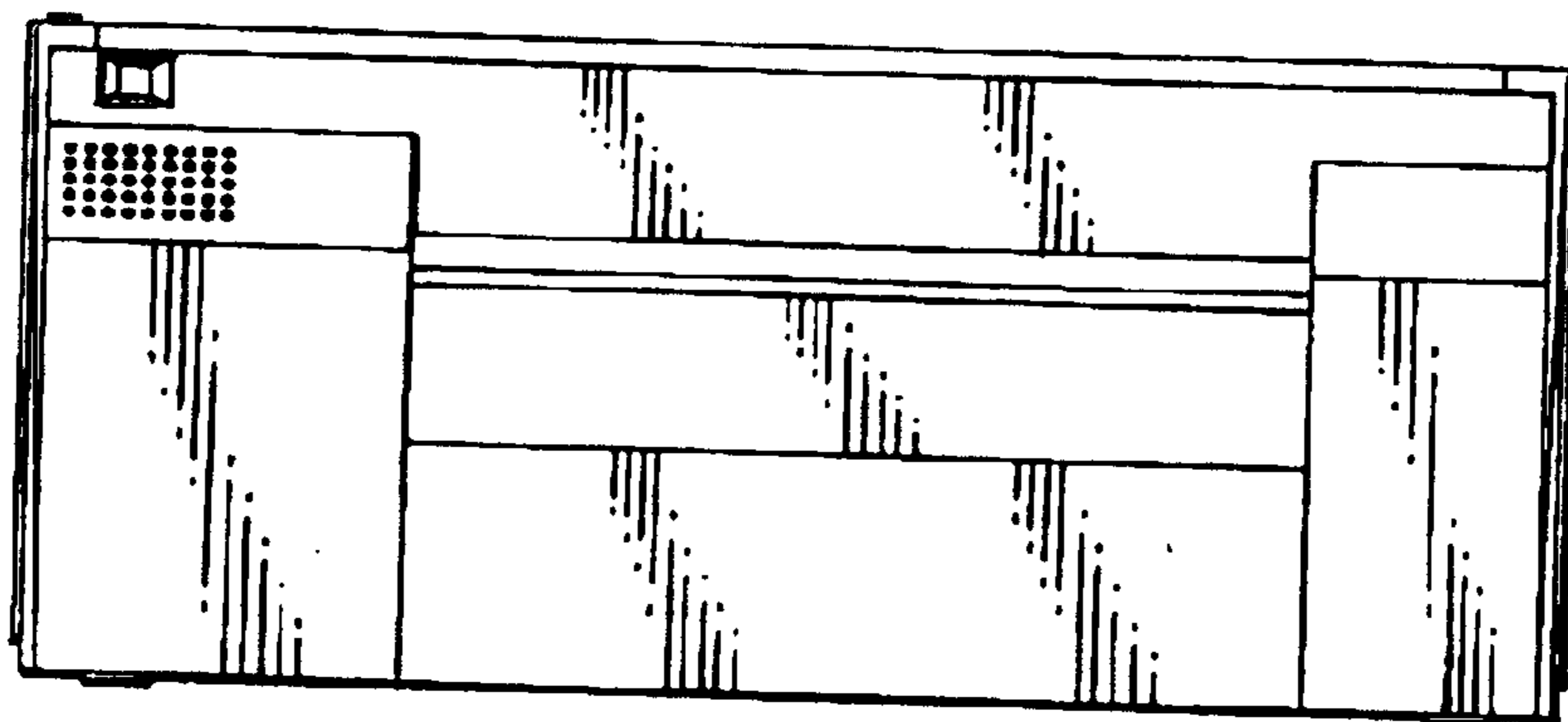

FIG. 3

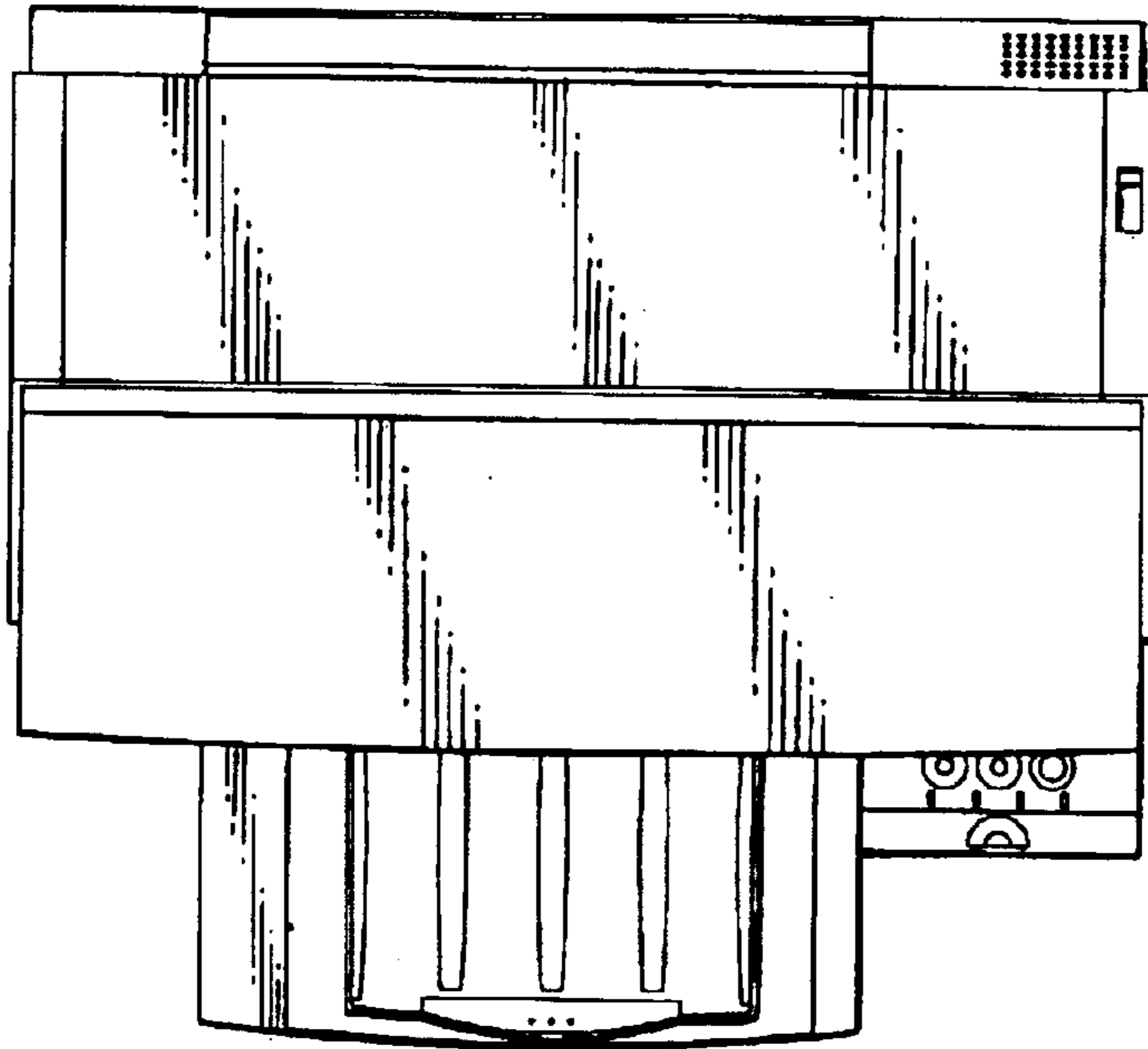

FIG. 4

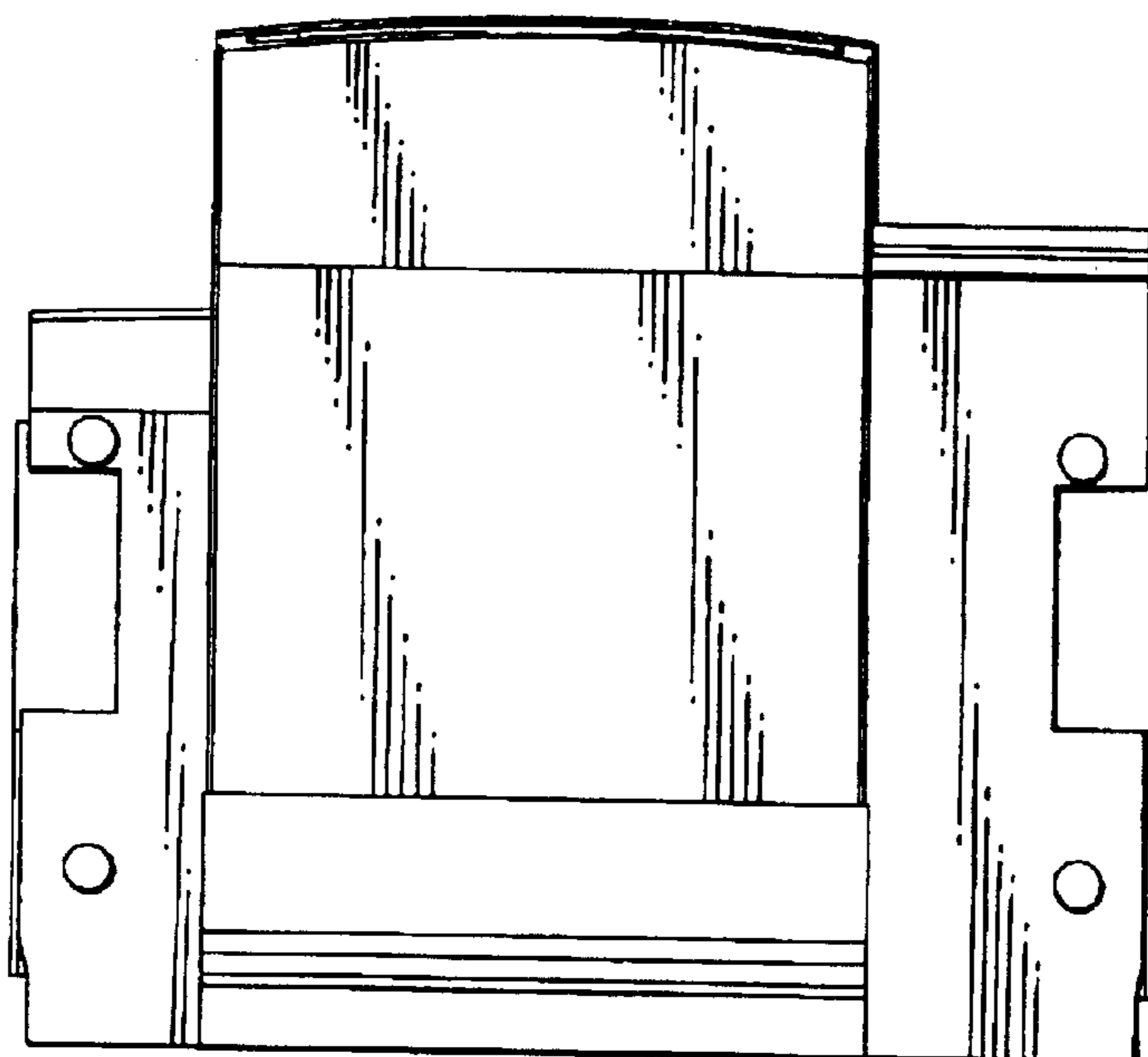

FIG. 5

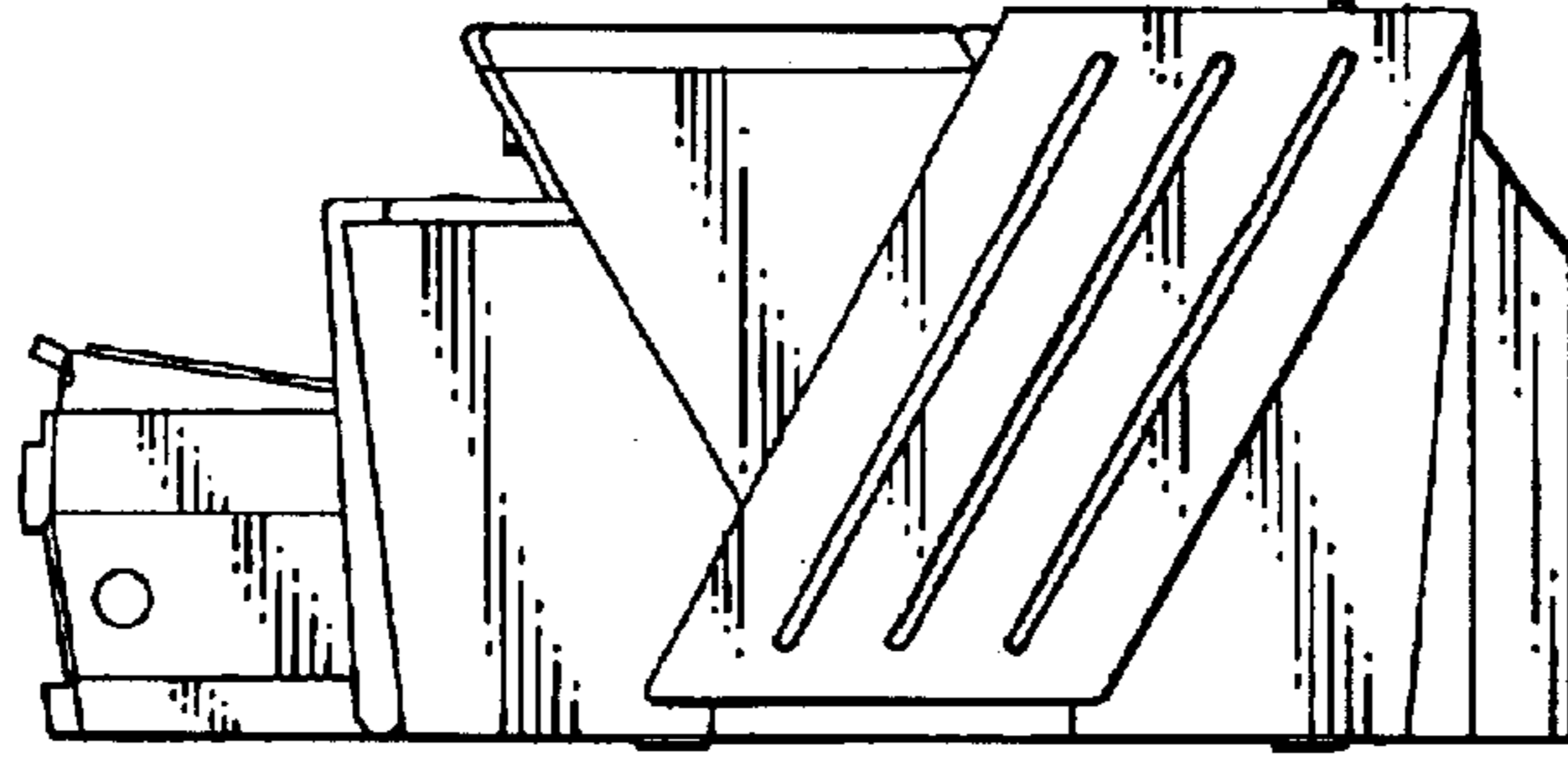

FIG. 6

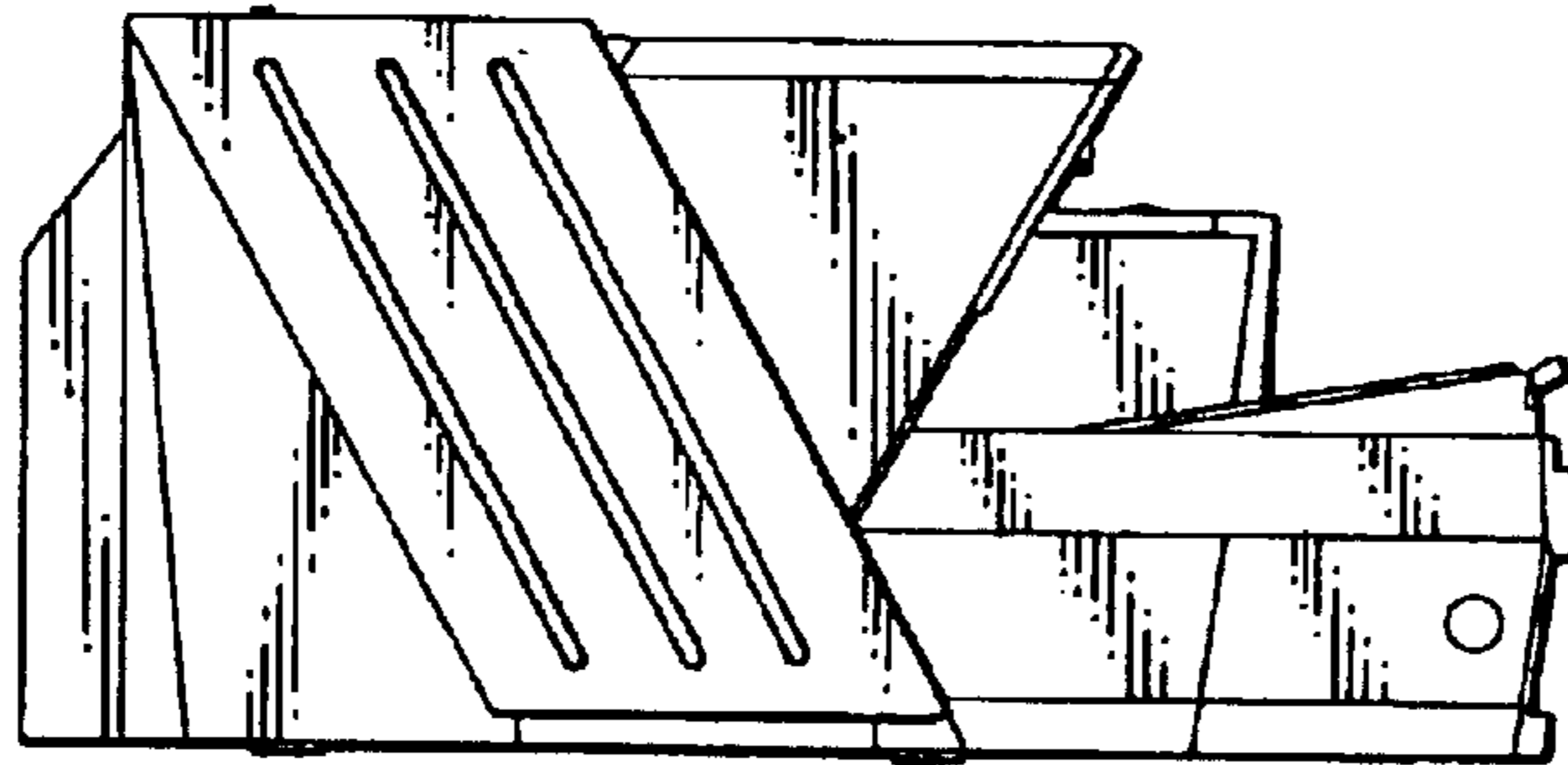

FIG. 7

