



US00D497908S1

(12) **United States Design Patent** (10) **Patent No.:** **US D497,908 S**
Poole et al. (45) **Date of Patent:** **** Nov. 2, 2004**

(54) **PERSONAL COMPUTER ENCLOSURE AND STAND**

(75) Inventors: **Anton Poole**, Dakota Dunes, SD (US);
Daniel K. Harden, Palo Alto, CA (US);
Hiroto Teranishi, Palo Alto, CA (US)

(73) Assignee: **Gateway, Inc.**, Poway, CA (US)

(**) Term: **14 Years**

(21) Appl. No.: **29/187,723**

(22) Filed: **Aug. 6, 2003**

(51) **LOC (7) Cl.** **14-02**

(52) **U.S. Cl.** **D14/349**

(58) **Field of Search** D14/363-368,
D14/349, 351-353; D13/162, 184, 199;
312/223.1, 223.3; 360/99.01-99.12; 369/34.01,
36.01; 361/690-696; 369/75.2

(56) **References Cited**

U.S. PATENT DOCUMENTS

5,105,414 A	*	4/1992	Funabashi et al.	369/75.2
D406,116 S	*	2/1999	Huber et al.	D14/351
D417,864 S	*	12/1999	Holtzman et al.	D14/351
D422,272 S	*	4/2000	Liang	D14/353
D478,077 S	*	8/2003	Poole et al.	D14/349

D478,078 S * 8/2003 Miao et al. D14/349

* cited by examiner

Primary Examiner—Freda S. Nunn

(74) *Attorney, Agent, or Firm*—Scott Charles Richardson;
Gateway Inc.

(57) **CLAIM**

The ornamental design for a personal computer enclosure and stand, as shown and described.

DESCRIPTION

FIG. 1 is a front perspective view of the PC enclosure and stand showing the design in the tower configuration;
 FIG. 2 is a left elevation view thereof;
 FIG. 3 is a right elevation view thereof;
 FIG. 4 is front elevation view thereof;
 FIG. 5 is a rear elevation view thereof;
 FIG. 6 is a top plan view thereof;
 FIG. 7 is a bottom plan view thereof;
 FIG. 8 is a front perspective view of the PC enclosure showing the design in the desktop configuration;
 FIG. 9 is a front elevation view thereof;
 FIG. 10 is a back elevation view thereof.
 FIG. 11 is a top plan view thereof;
 FIG. 12 is a left elevation view thereof;
 FIG. 13 is a bottom plan view thereof; and,
 FIG. 14 is a right elevation view thereof.

1 Claim, 6 Drawing Sheets

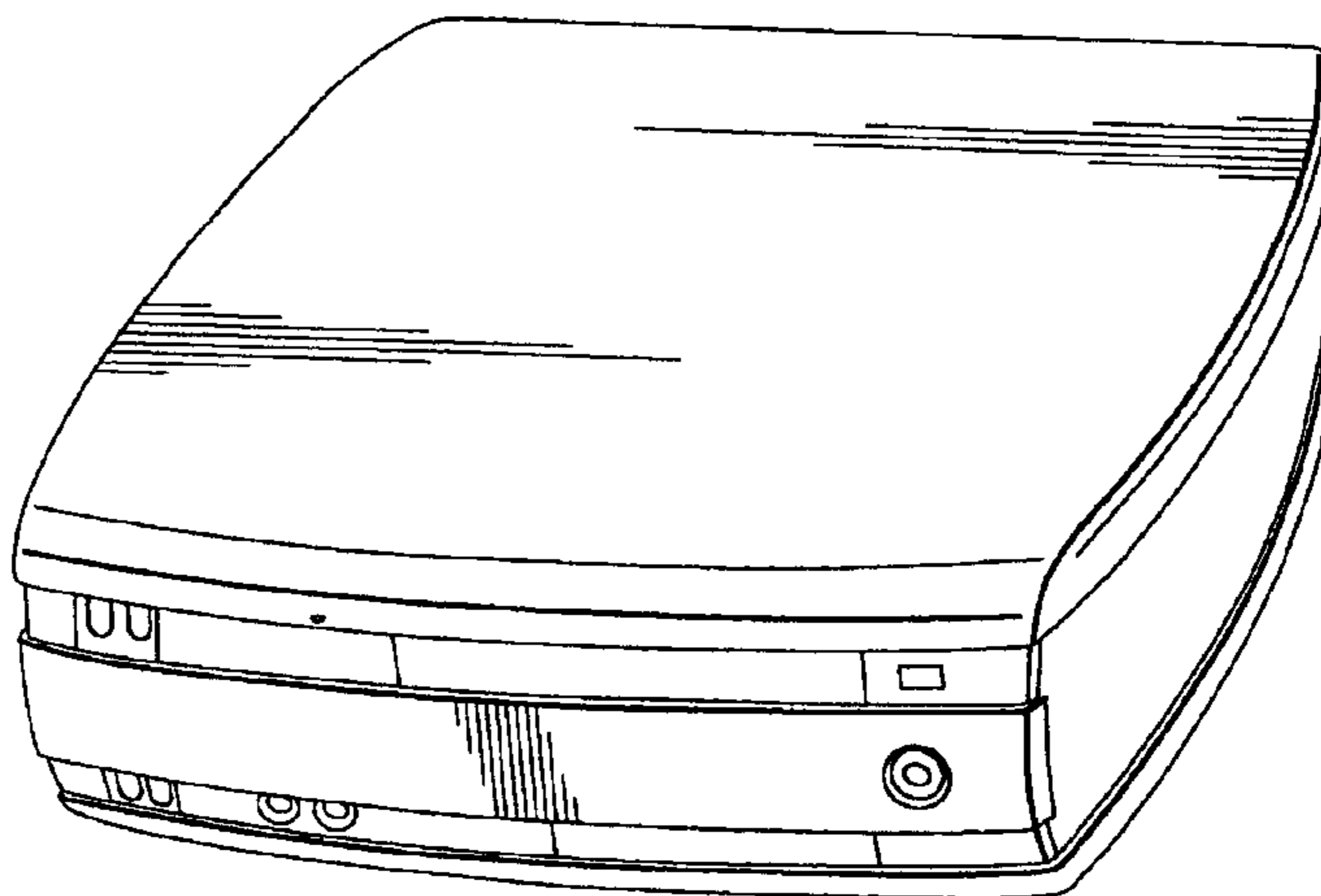
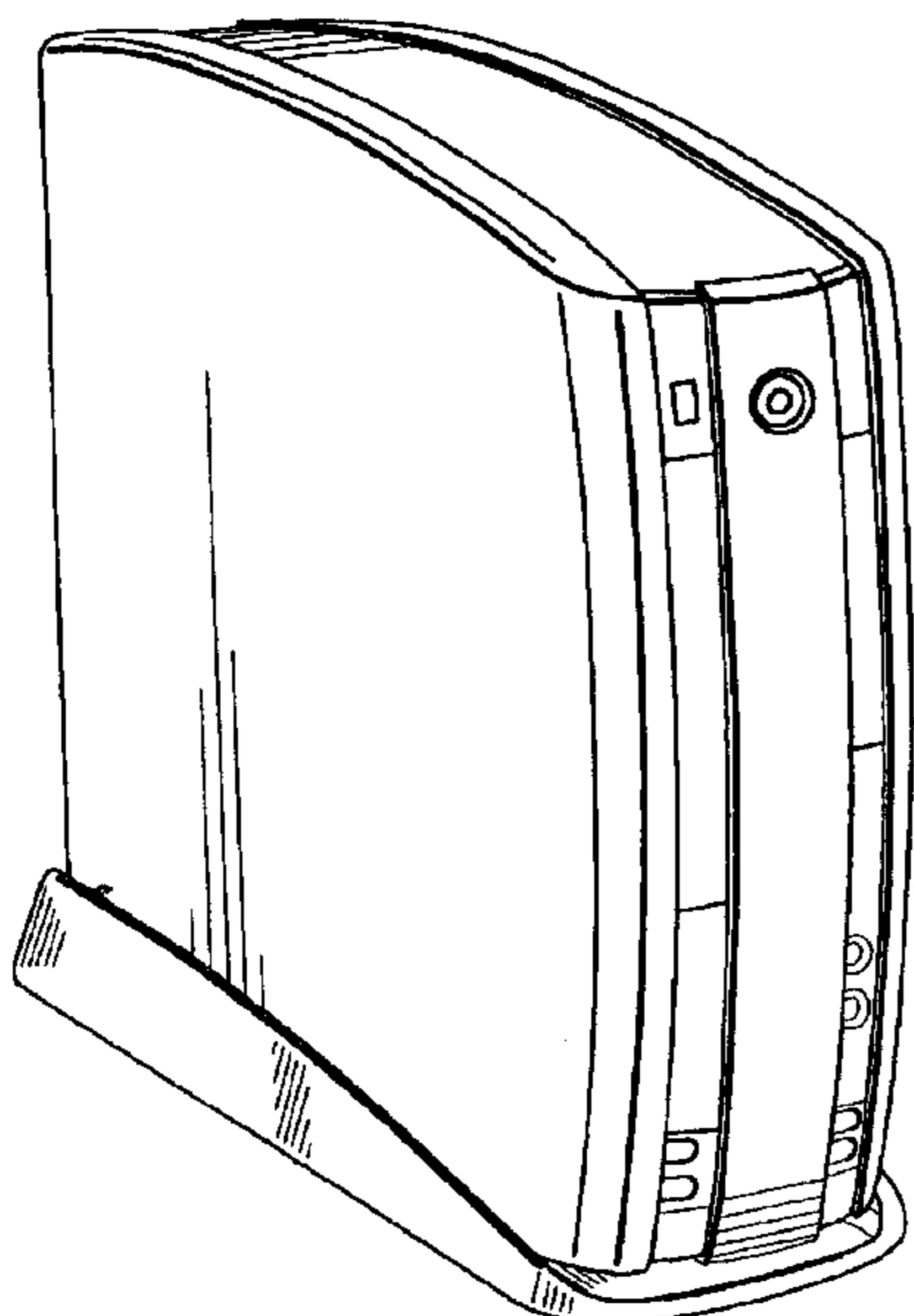

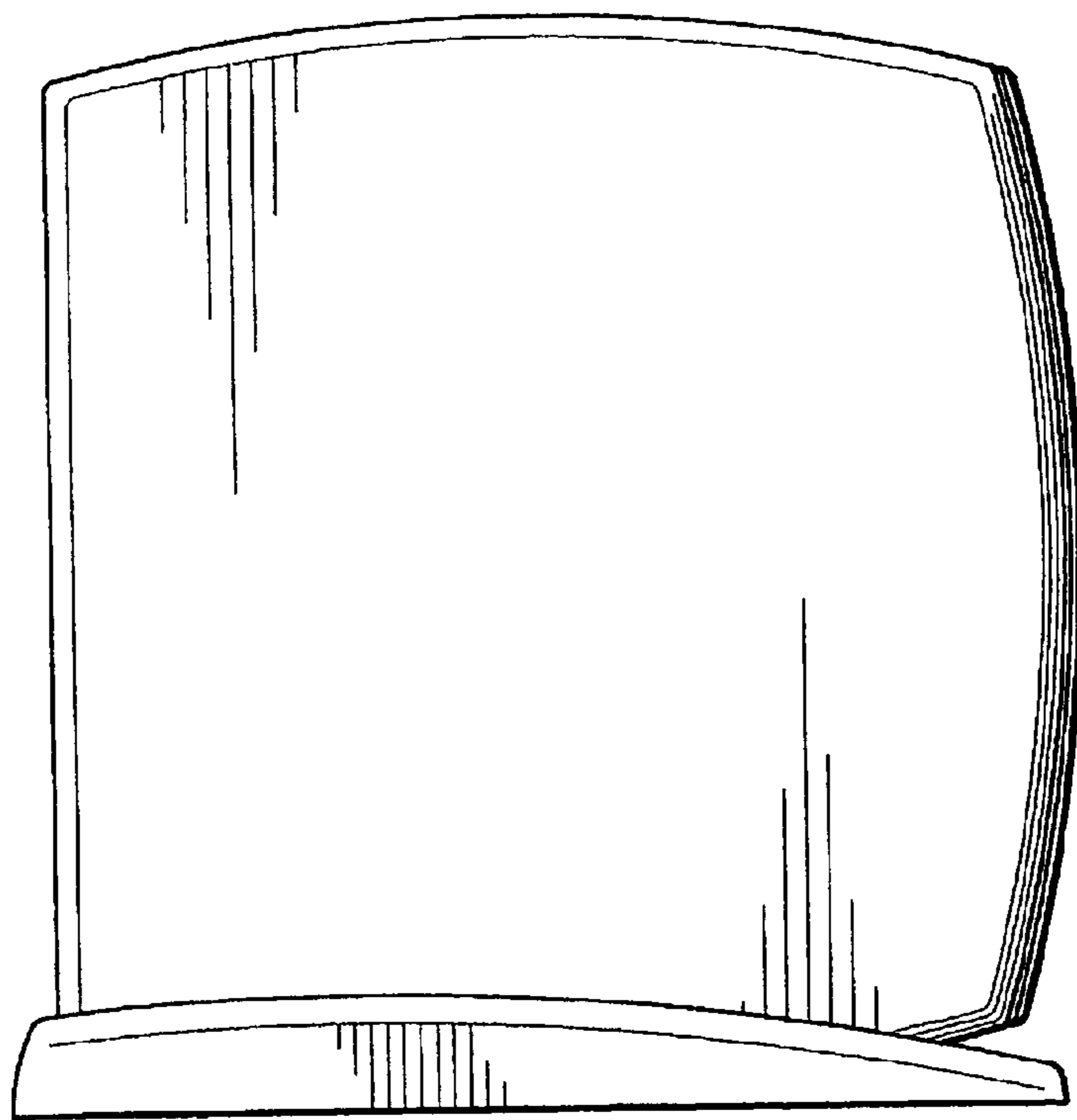
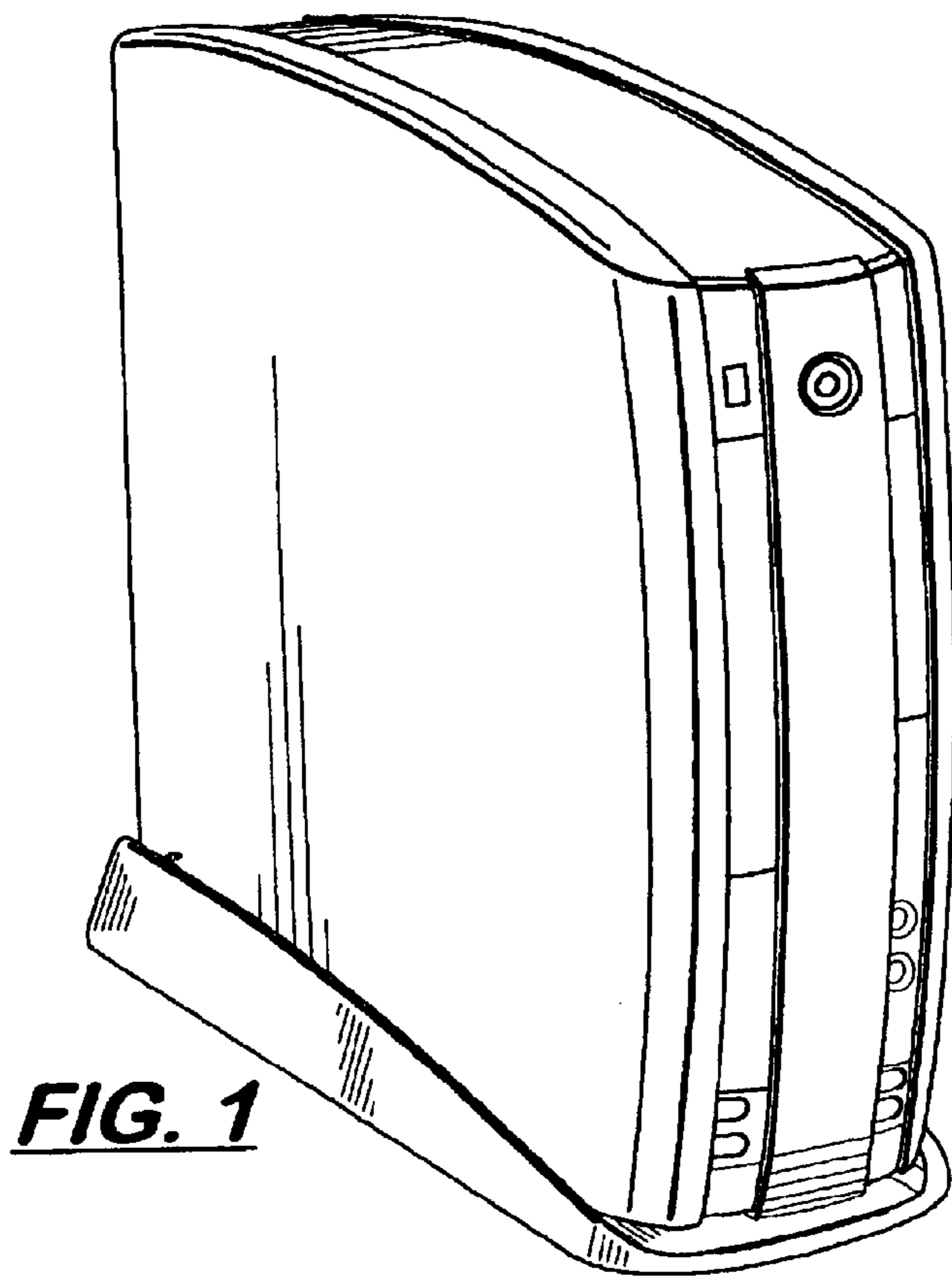

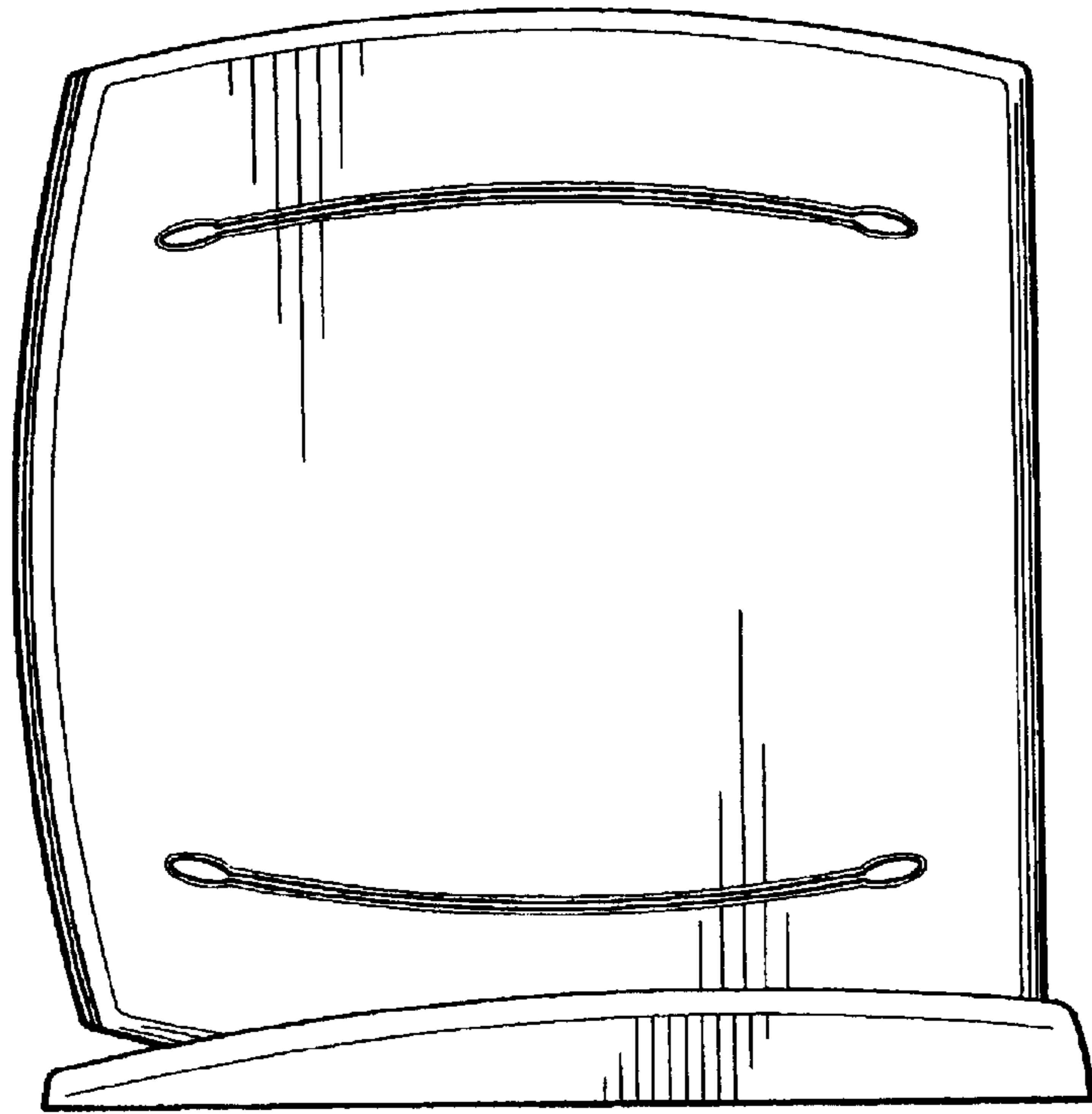

FIG. 3

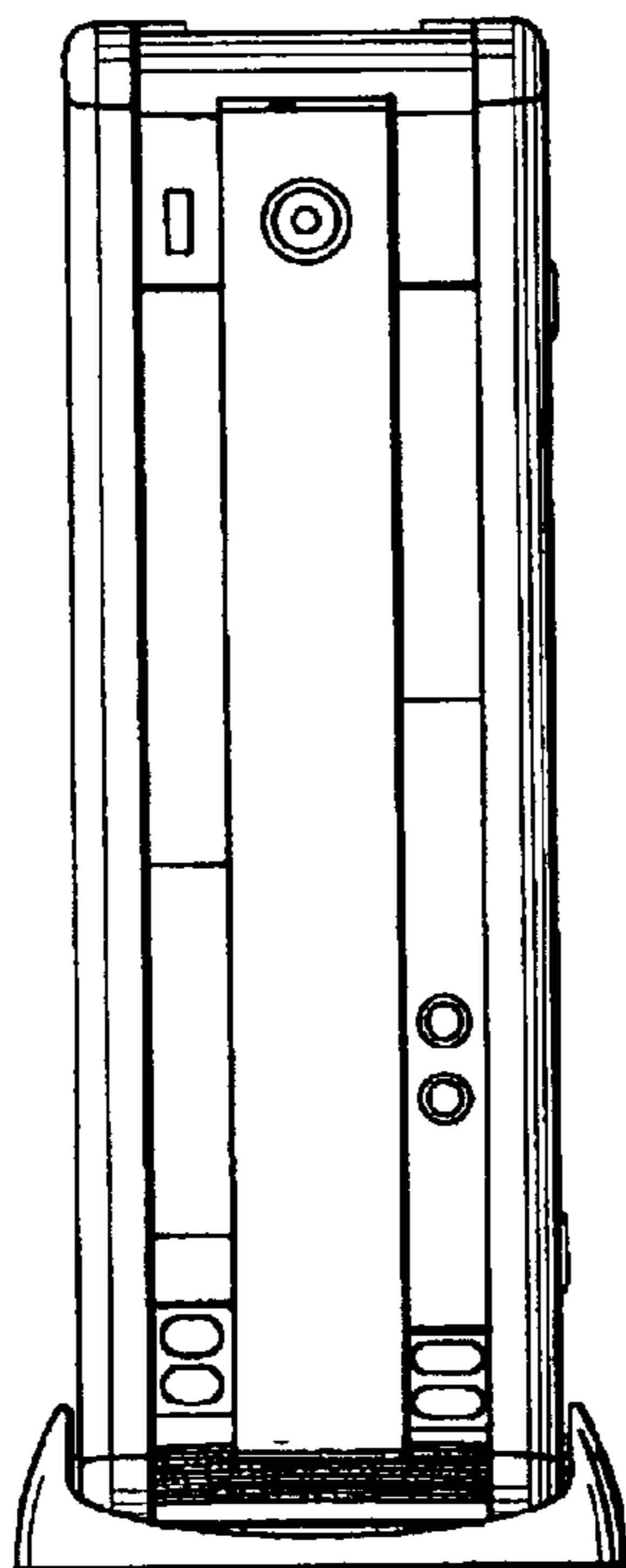

FIG. 4

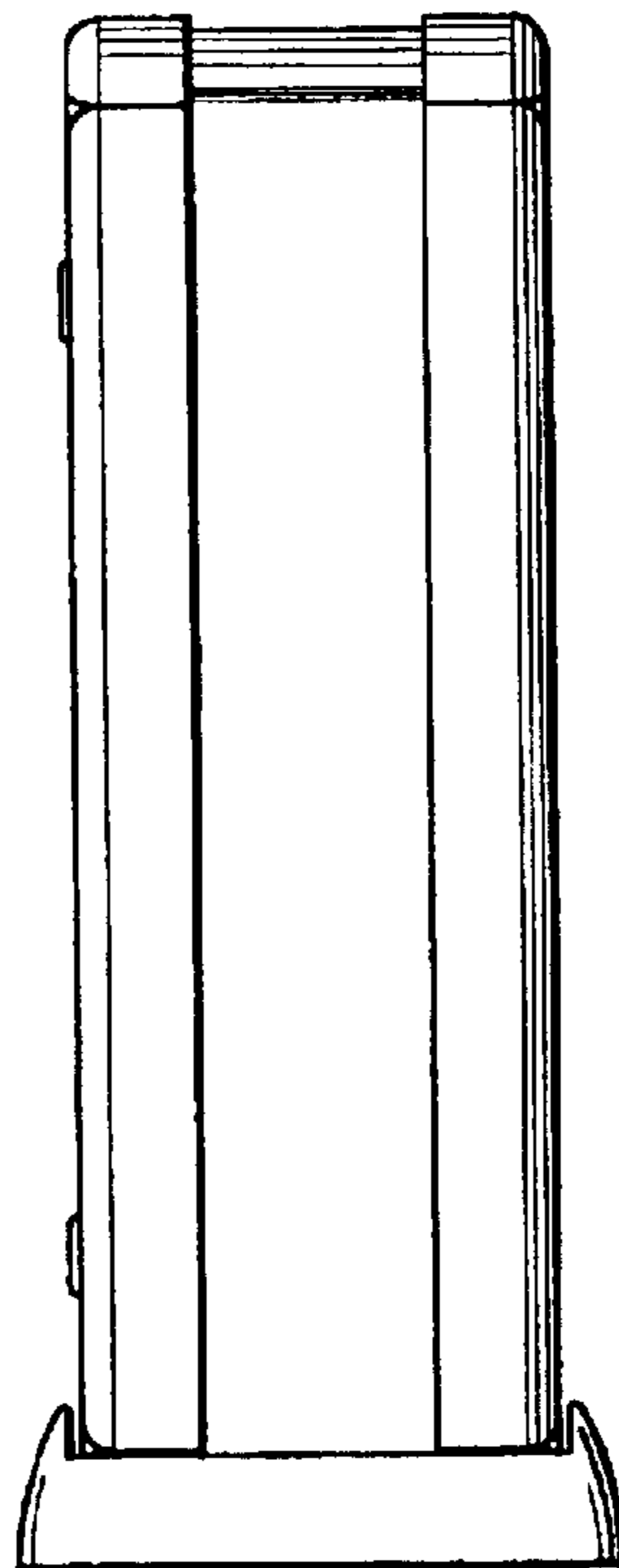

FIG. 5

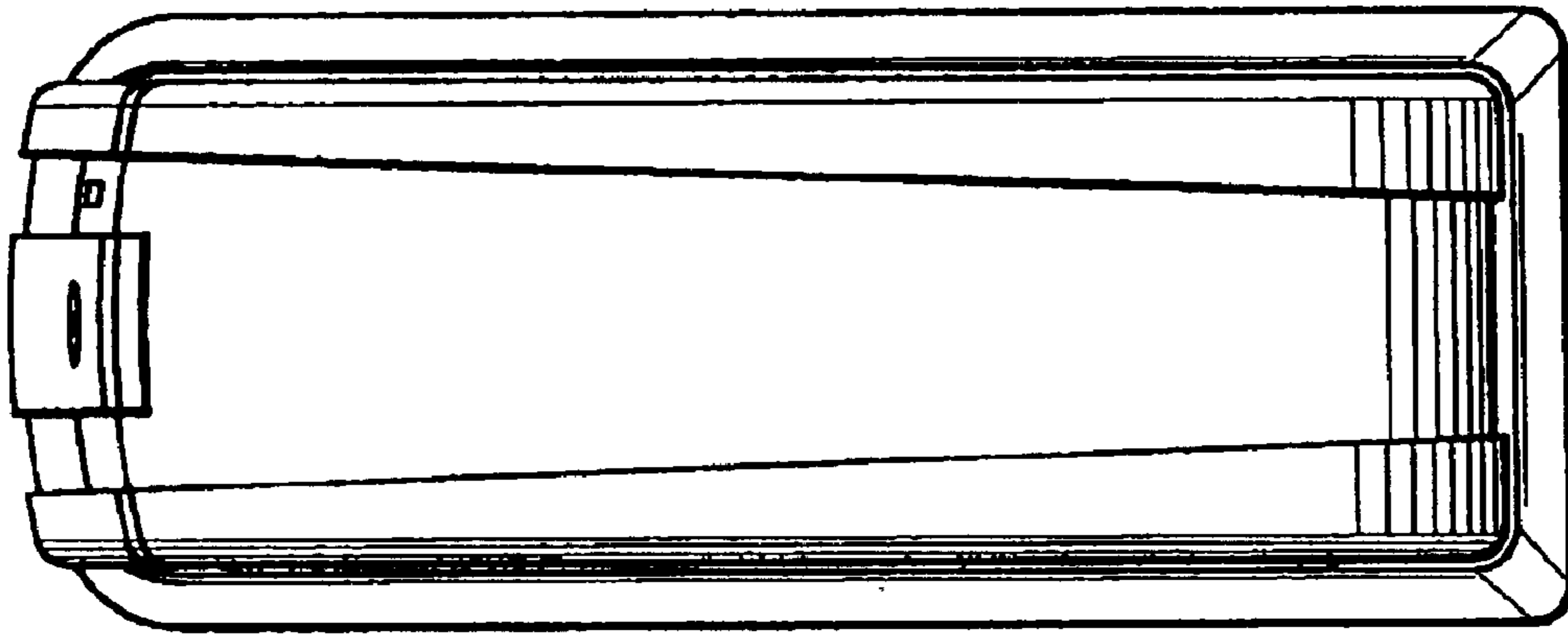

FIG. 6

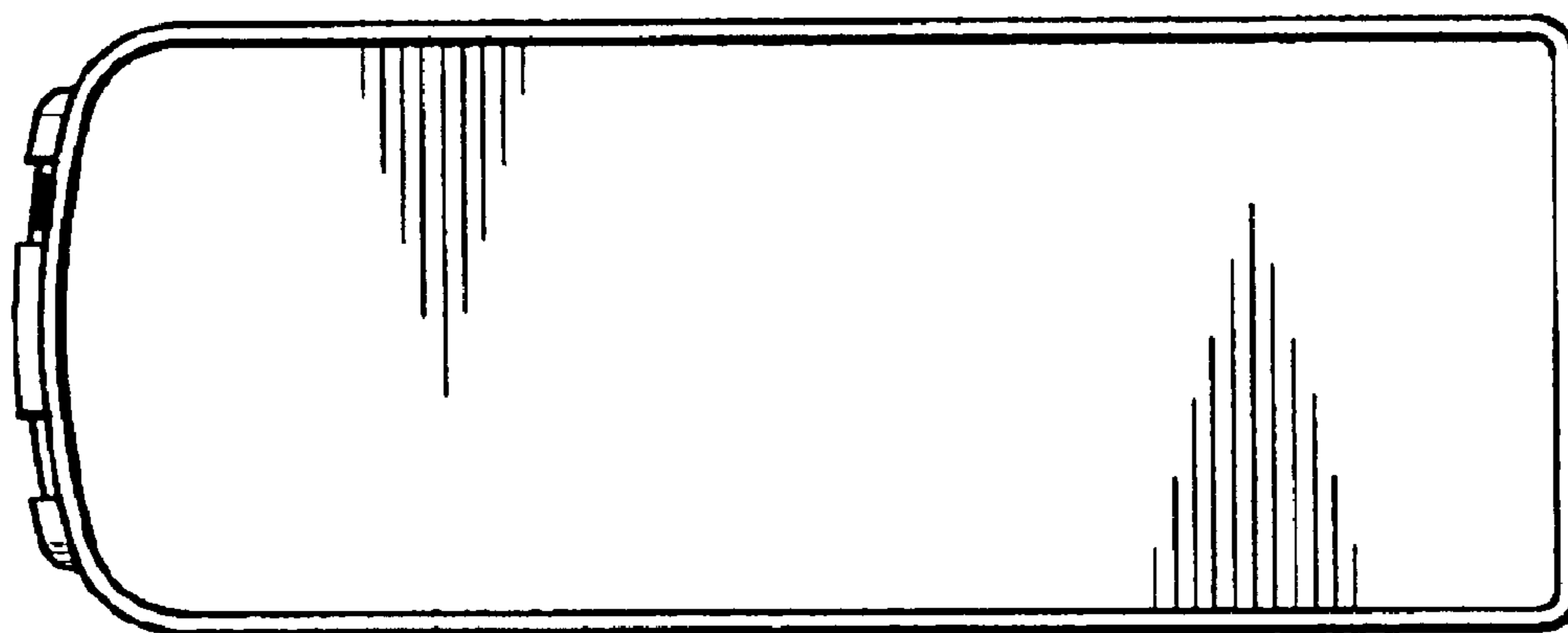

FIG. 7

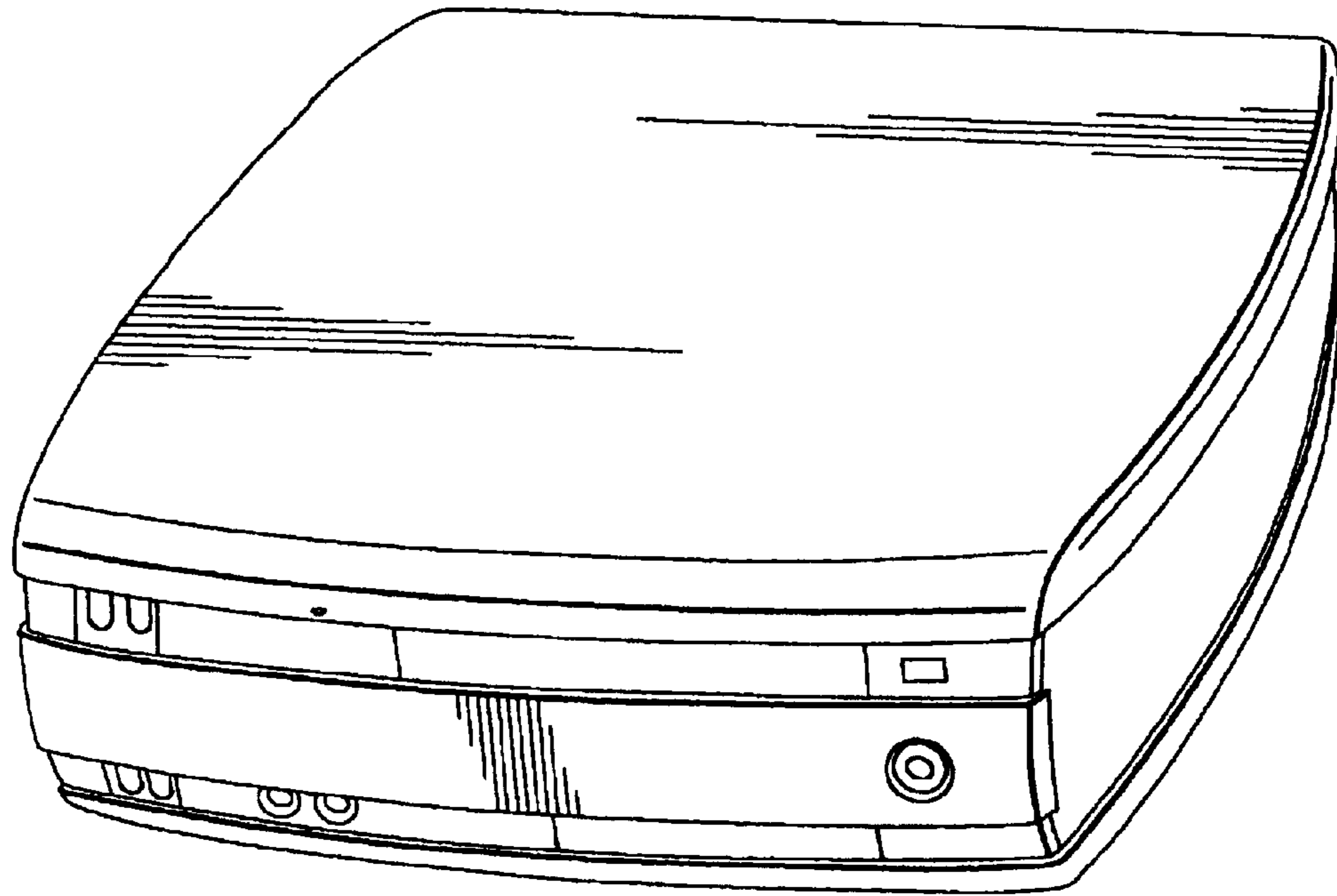

FIG. 8

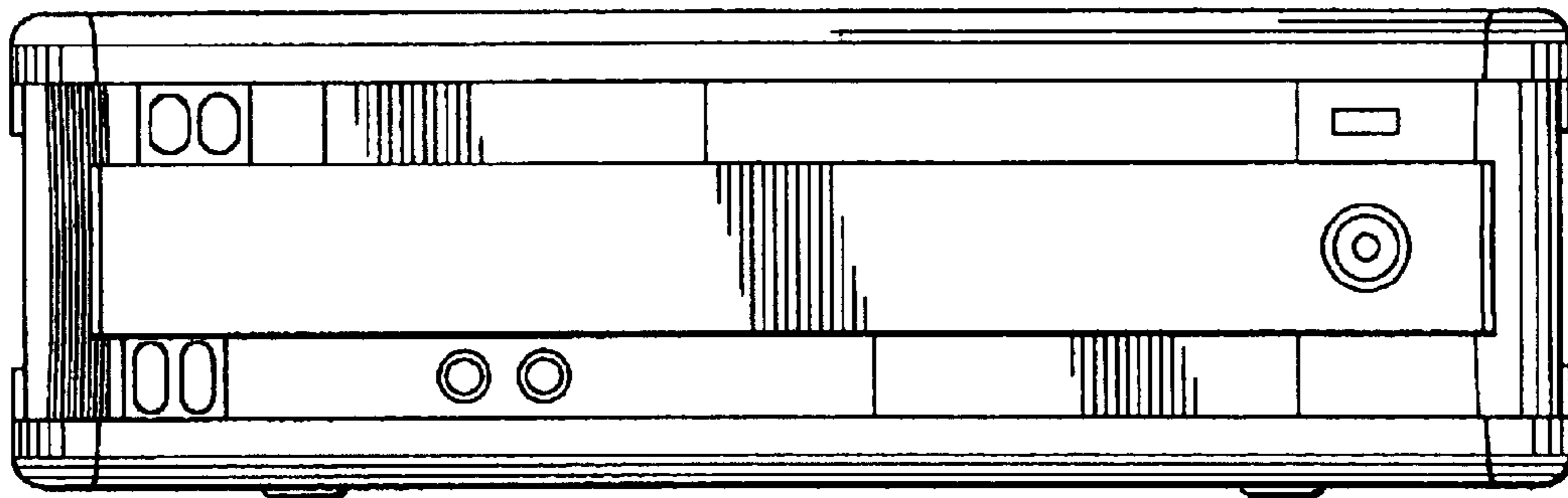

FIG. 9

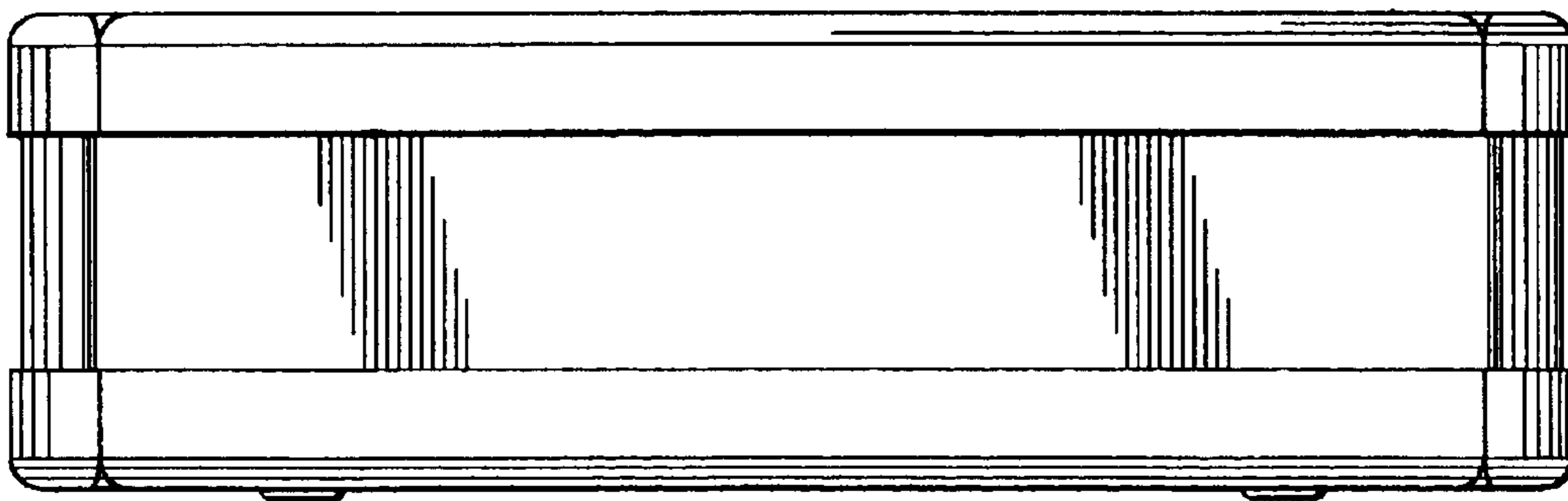

FIG. 10

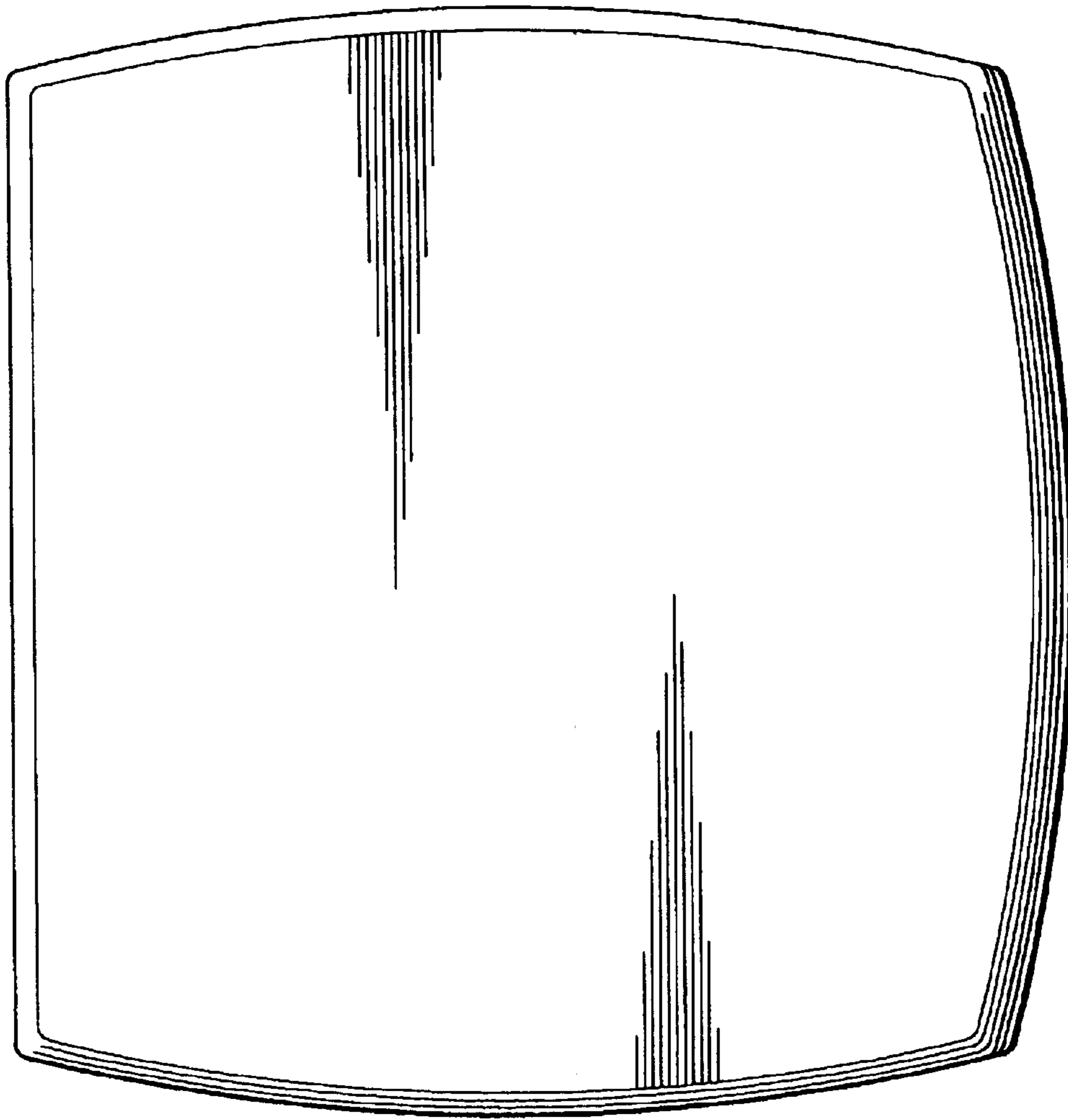

FIG. 11

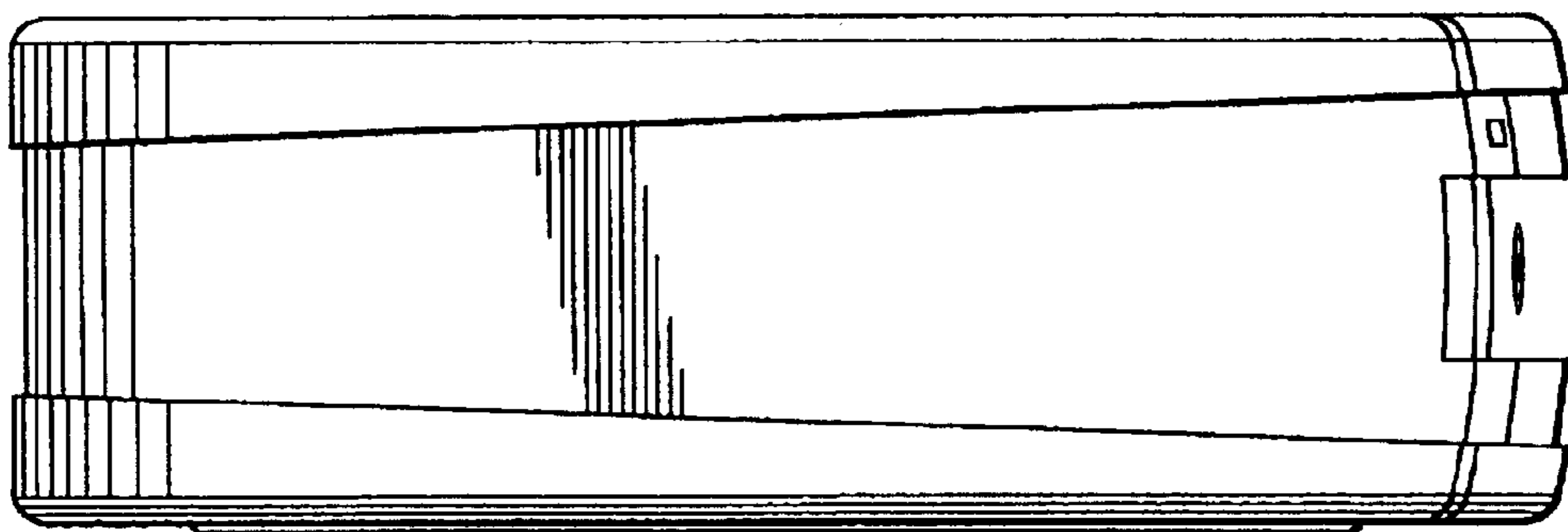

FIG. 12

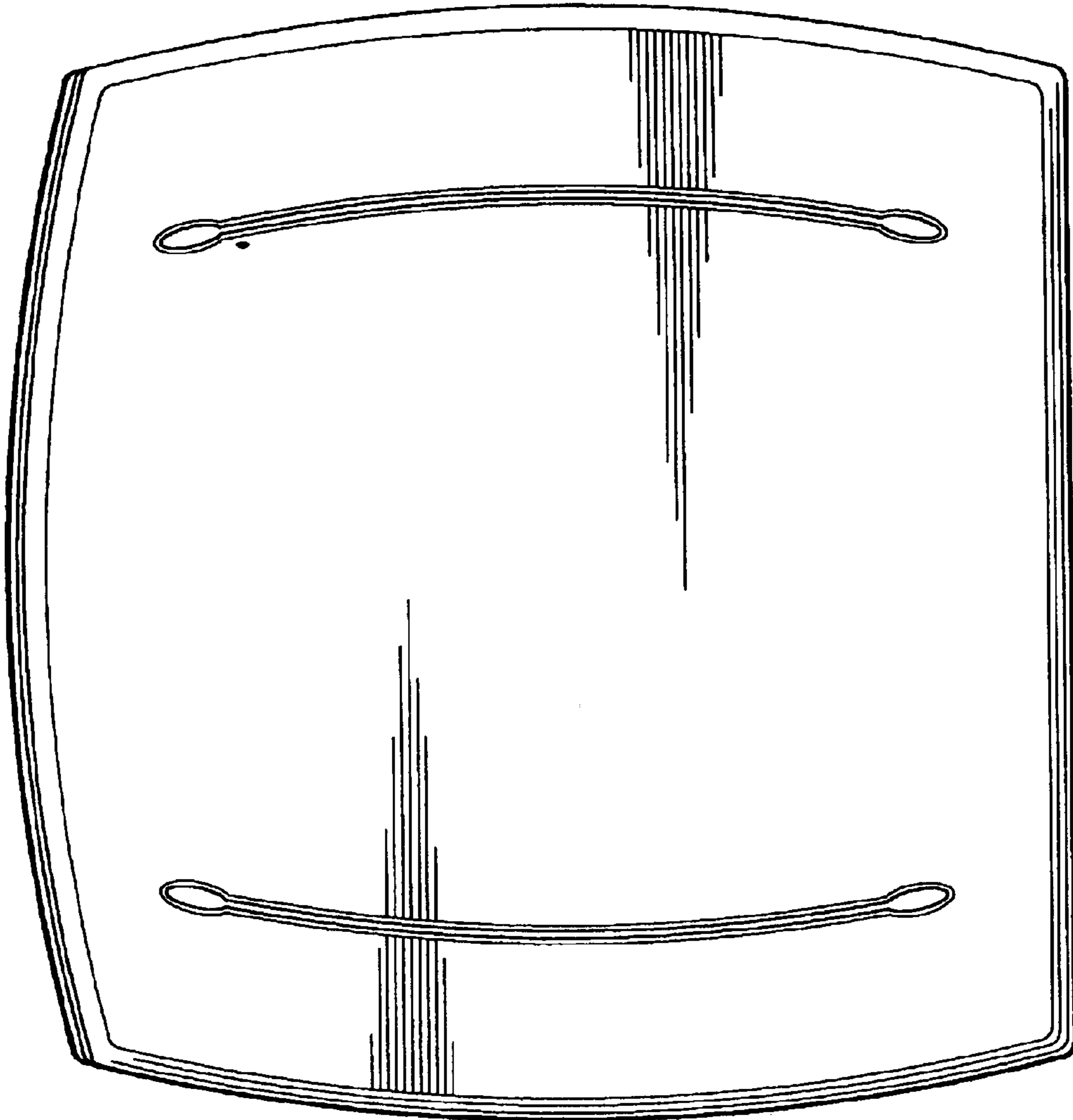

FIG. 13

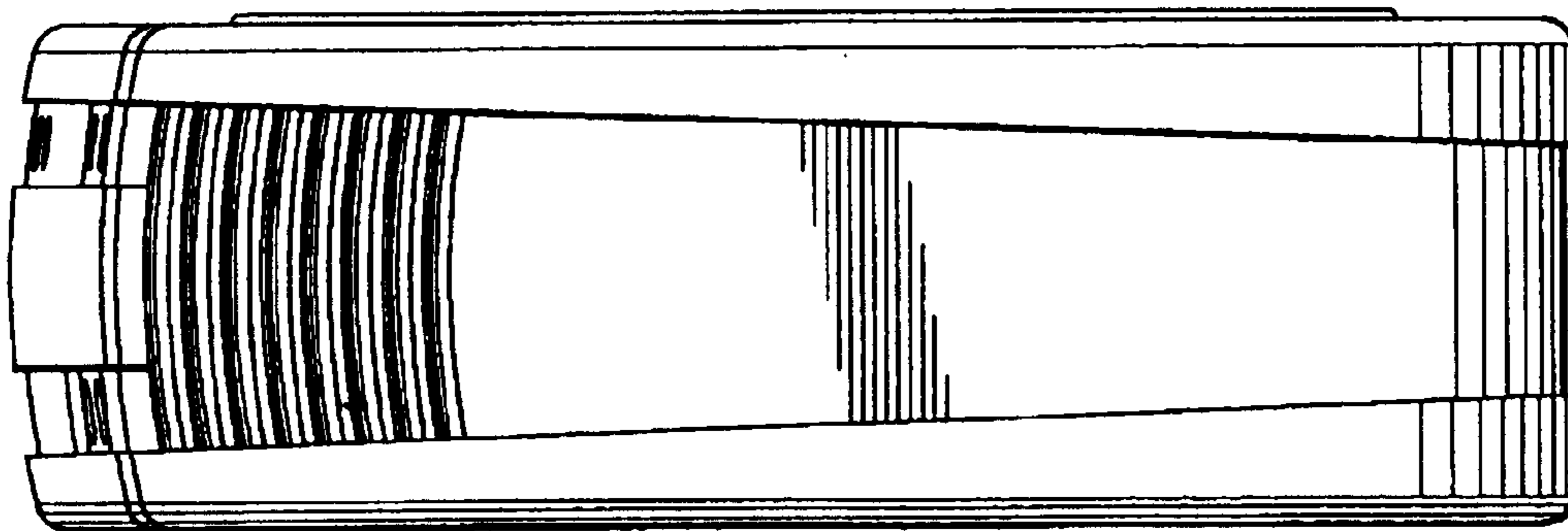

FIG. 14