



US00D497757S1

(12) **United States Design Patent** (10) **Patent No.:** **US D497,757 S**  
**Kringel et al.** (45) **Date of Patent:** **\*\* Nov. 2, 2004**

(54) **DISPLAY TRAY FOR A SHELF MOUNTED PRODUCT DISPLAY DEVICE**

6,109,599 A 8/2000 Kringel  
6,357,713 B1 3/2002 BeBow

(75) Inventors: **George N. Kringel**, Westport, CT (US);  
**Frank Calderazzo**, Englewood, FL (US); **Robert S. Frichette**, Trumbull, CT (US); **Arthur A. Rotelli, III**, Fairfield, CT (US)

**FOREIGN PATENT DOCUMENTS**

WO WO 01/15576 A1 8/2000

\* cited by examiner

*Primary Examiner*—Brian N Vinson

(73) Assignee: **News America Marketing**, Wilton, CT (US)

(74) *Attorney, Agent, or Firm*—St. Onge Steward Johnston & Reens LLC

(\*\*) Term: **14 Years**

(57) **CLAIM**

I claim the ornamental design for a display tray for a shelf mounted product display device, as shown in the drawings.

(21) Appl. No.: **29/186,932**

**DESCRIPTION**

(22) Filed: **Jul. 24, 2003**

(51) **LOC (7) Cl.** ..... **06-04**

(52) **U.S. Cl.** ..... **D6/574**

(58) **Field of Search** ..... D6/552, 553, 567, D6/574; 211/13.1, 69.1, 70.6, 70.7, 71-72, 74-75, 86.01, 87.01, 88.01, 90.01, 126.1

FIG. 1 is a perspective view of the display tray for a shelf mounted product display device showing our new design. FIG. 2 is a front view of the display tray for a shelf mounted product display device. FIG. 3 is a back view of the display tray for a shelf mounted product display device. FIG. 4 is a side view of the display tray for a shelf mounted product display device. FIG. 5 is a top view of the display tray for a shelf mounted product display device. FIG. 6 is a bottom view of the display tray for a shelf mounted product display device. FIG. 7 is a perspective view of the display tray showing its surrounding environment including a shelf bracket; and, FIG. 8 is a side view of the display tray showing its surrounding environment. The broken-line disclosure in the views is for illustrative purposes only and forms no part of the claimed design.

(56) **References Cited**

**U.S. PATENT DOCUMENTS**

2,539,935 A	10/1951	Stephens et al.	
D185,897 S	* 8/1959	Stark	D6/574
D293,183 S	* 12/1987	Aaron	D6/567
5,240,125 A	8/1993	Kunz	
5,289,652 A	3/1994	Kringel et al.	
5,320,319 A	6/1994	Winger et al.	
5,344,250 A	9/1994	Kringel et al.	
D356,461 S	* 3/1995	May et al.	D6/567
D364,524 S	* 11/1995	Bassler et al.	D6/567
5,472,289 A	12/1995	Kringel et al.	
5,829,642 A	11/1998	Momboisse	
5,971,335 A	10/1999	Perrin et al.	

**1 Claim, 4 Drawing Sheets**

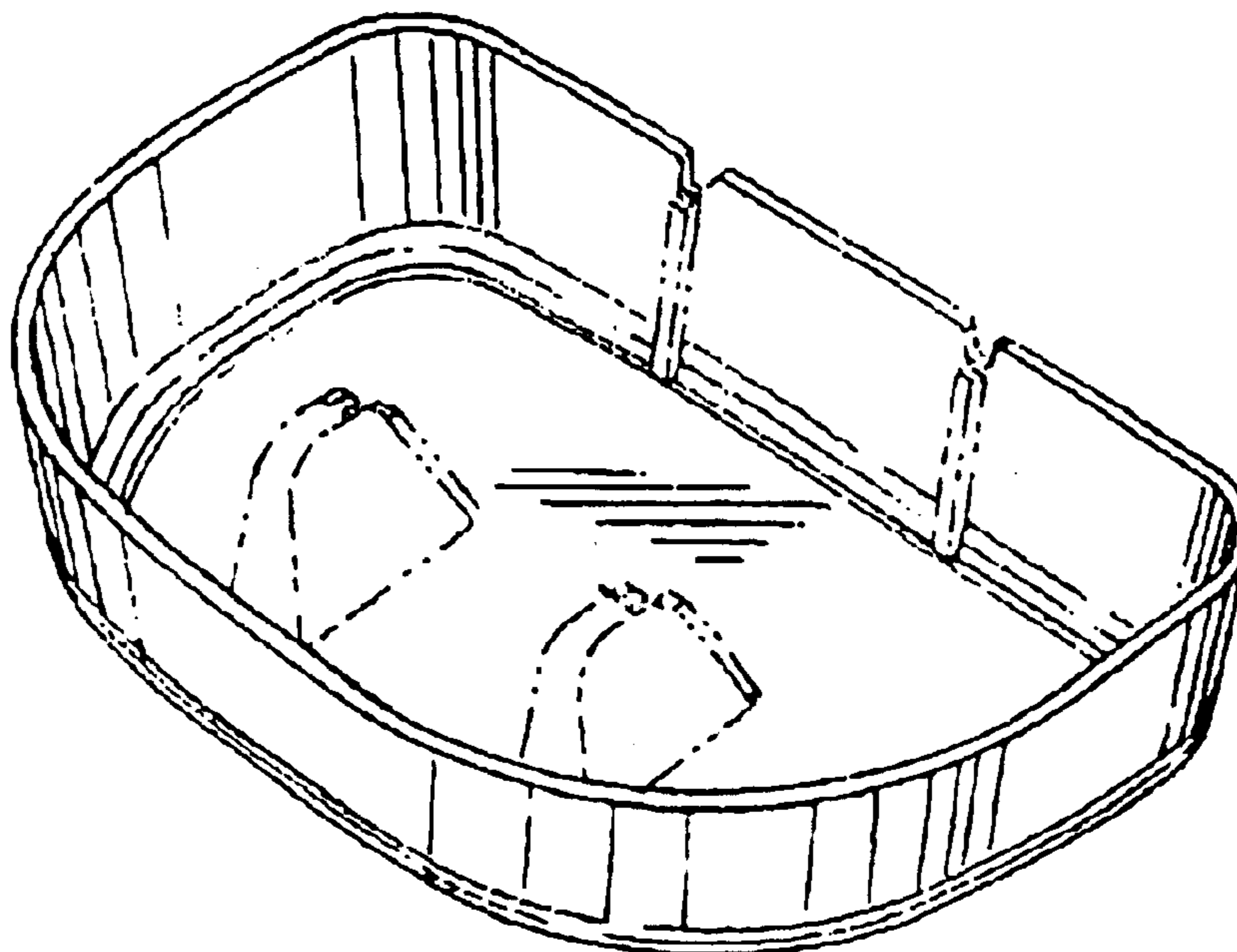

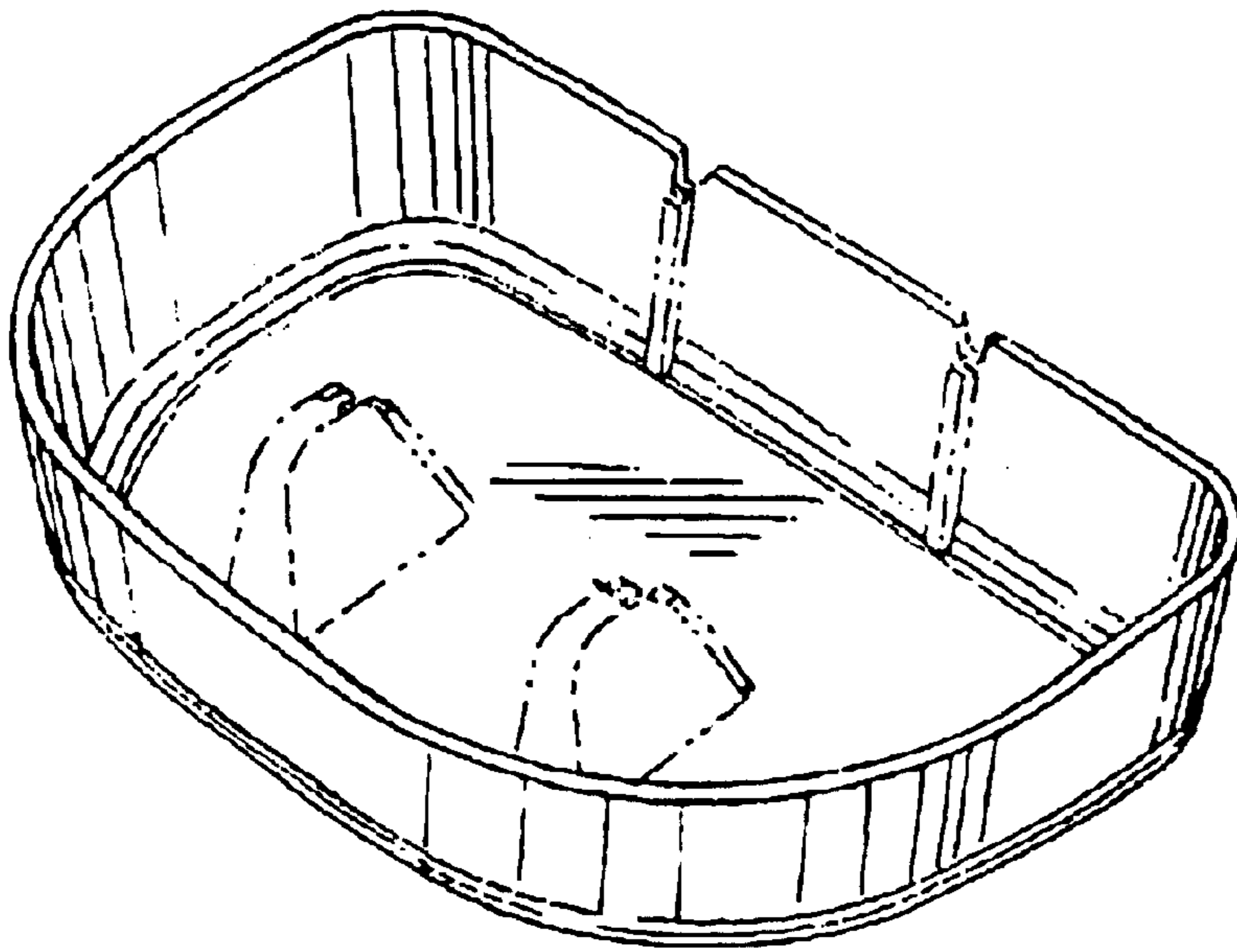

FIG. 1



FIG. 2

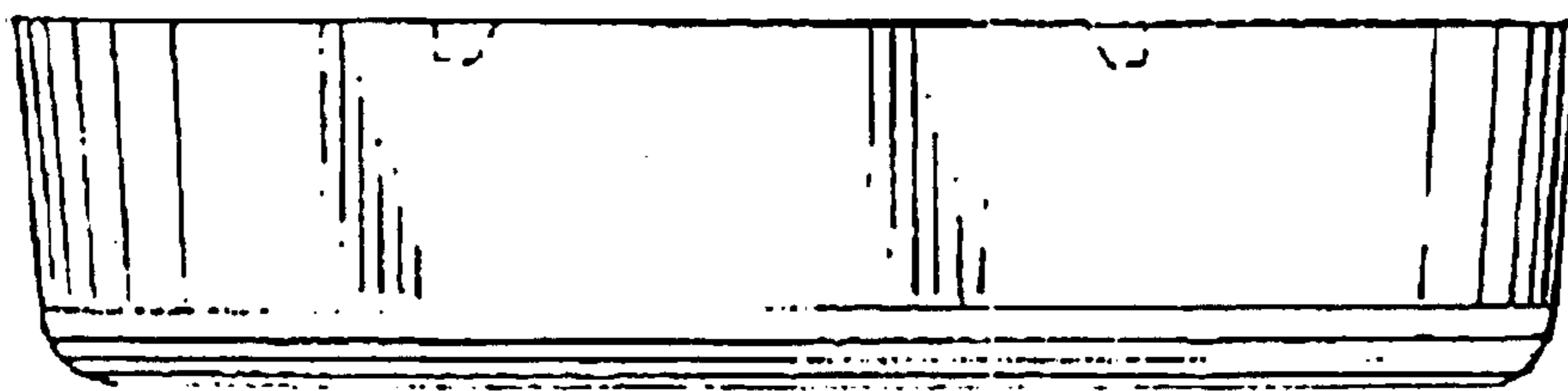

FIG. 3

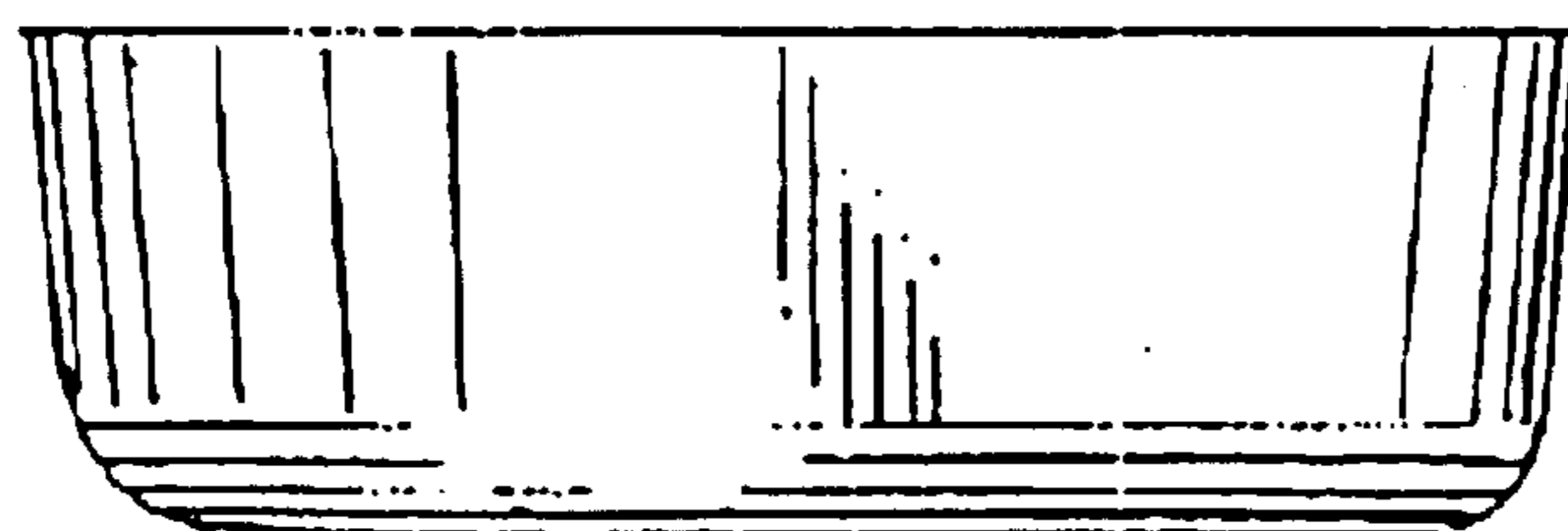
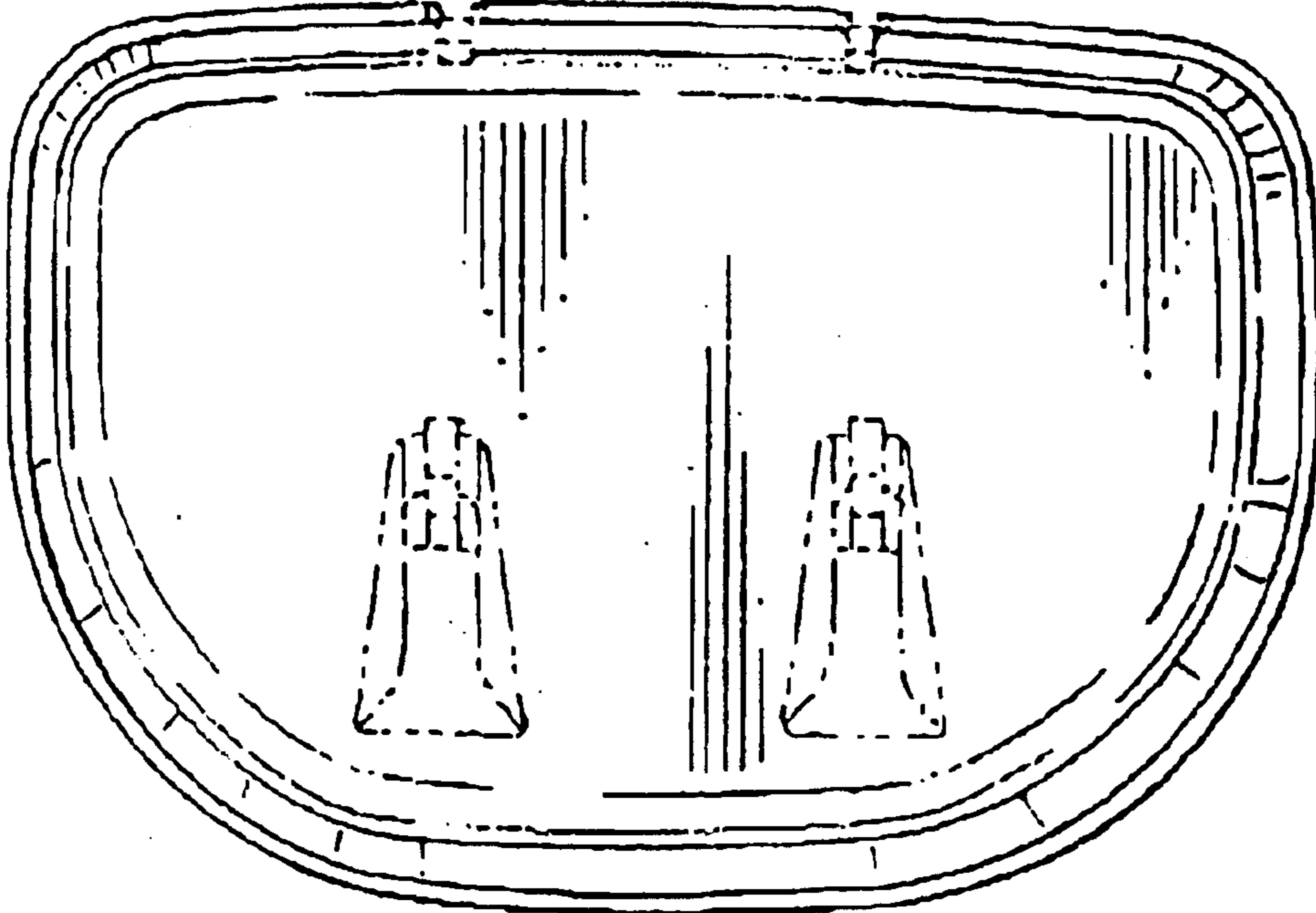
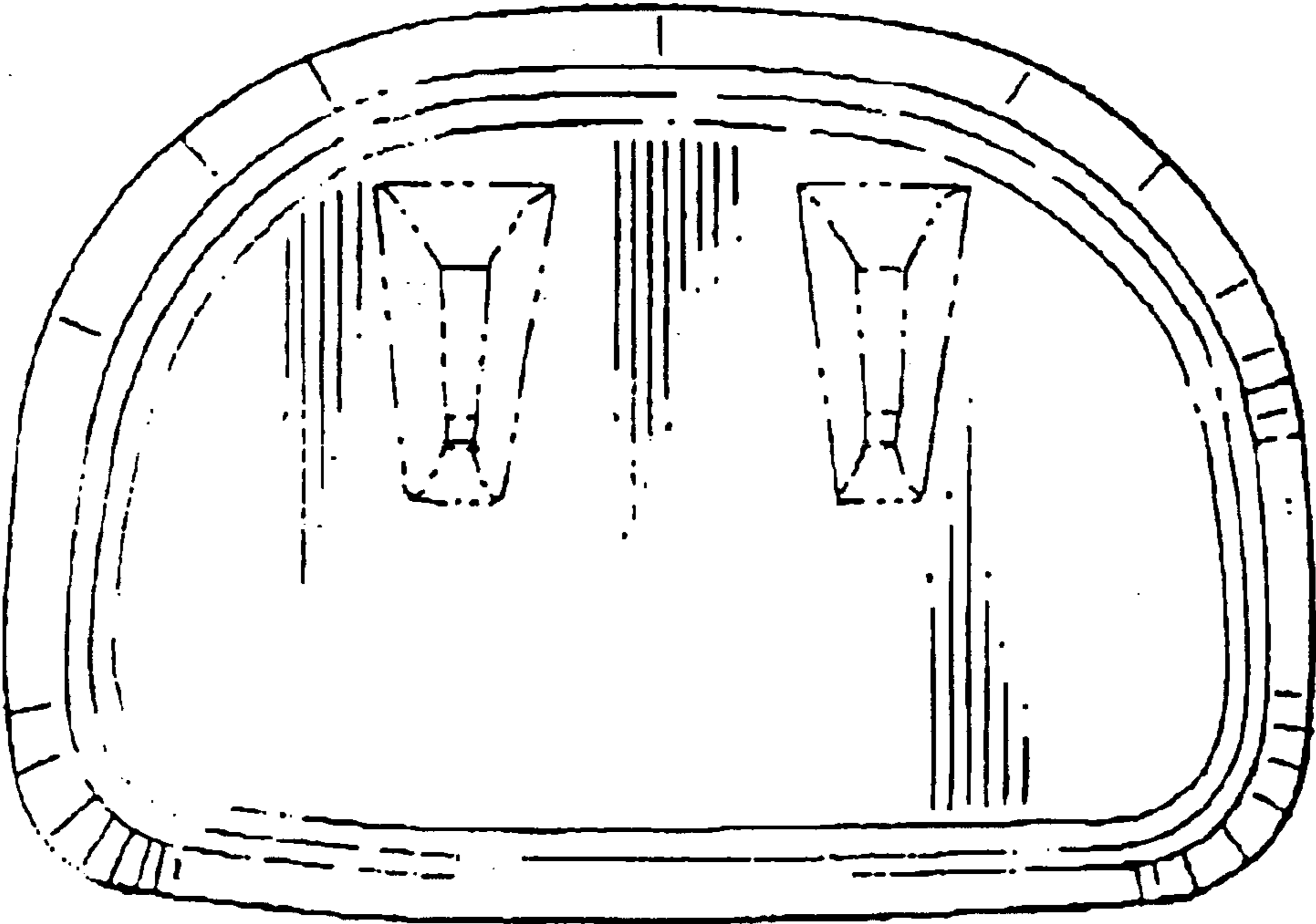

FIG. 4



*FIG. 5*



*FIG. 6*

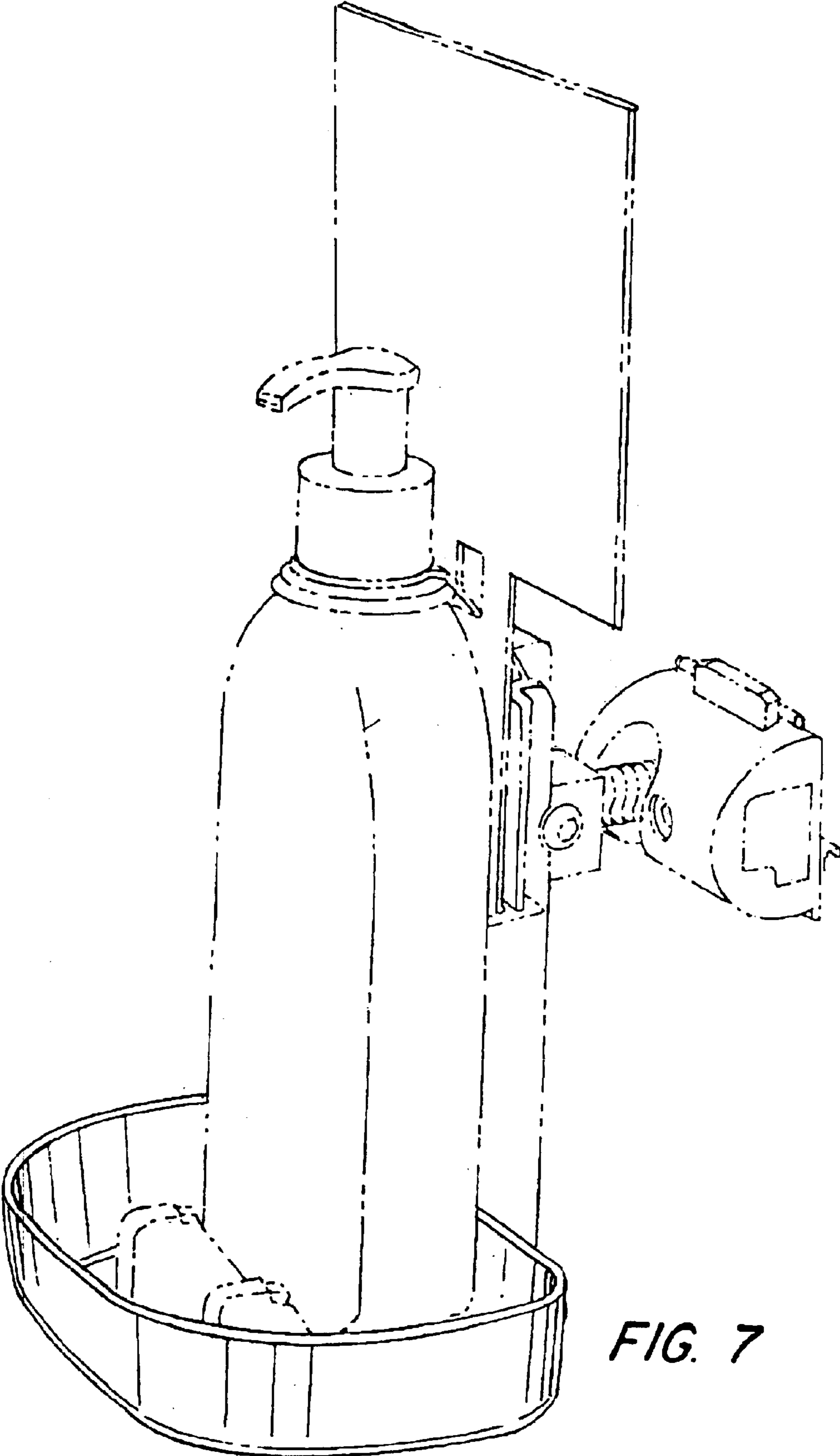

FIG. 7

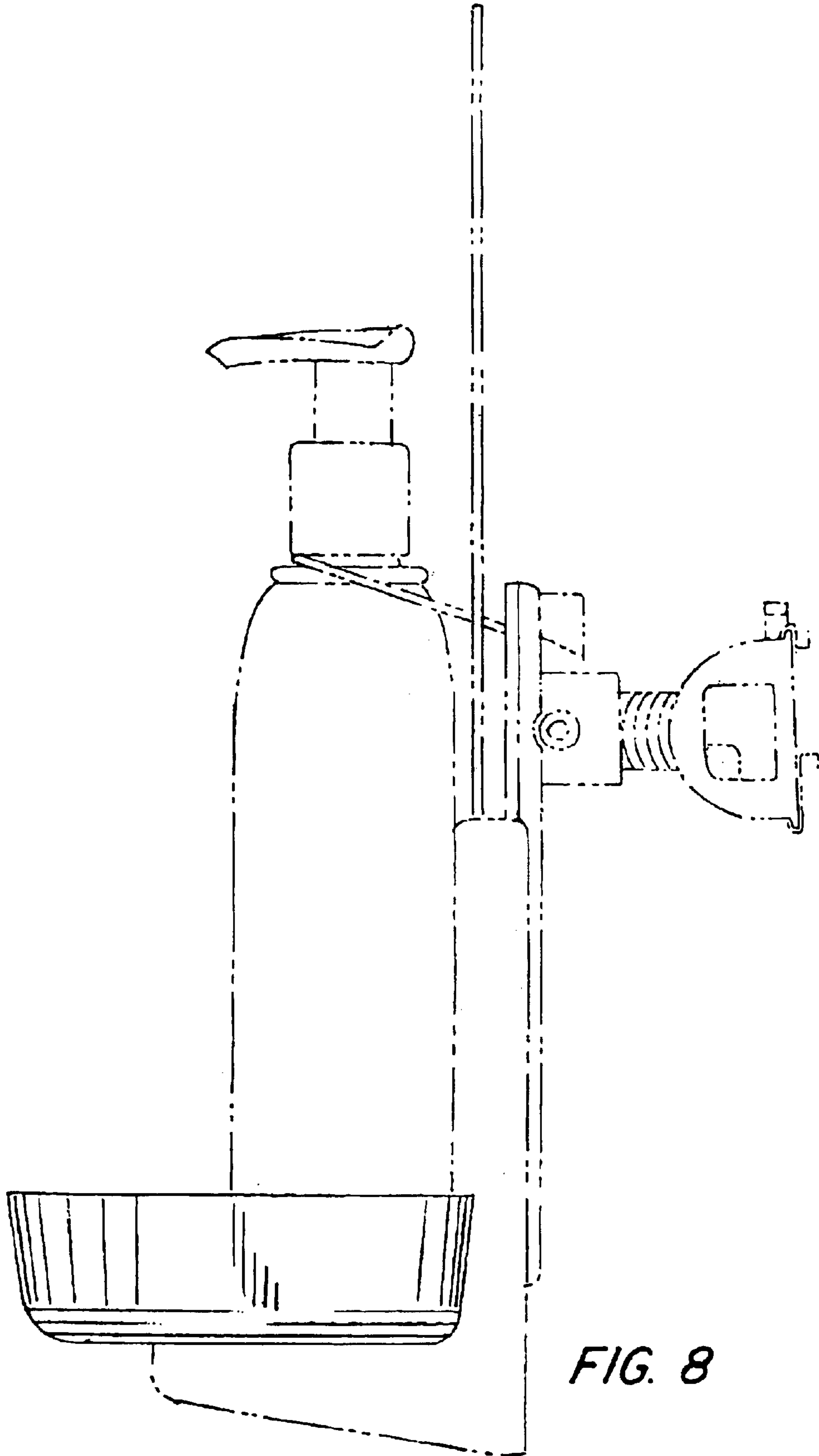

FIG. 8