

US00D497741S1

(12) **United States Design Patent** (10) **Patent No.:** **US D497,741 S**
Sexton (45) **Date of Patent:** **** Nov. 2, 2004**

(54) **AUDIO-VIDEO STORAGE UNIT**

(75) Inventor: **James S. Sexton**, Danville, CA (US)
 (73) Assignee: **Z-Line Designs**, San Ramon, CA (US)
 (**) Term: **14 Years**

(21) Appl. No.: **29/201,154**

(22) Filed: **Mar. 10, 2004**

(51) **LOC (7) Cl.** **06-04**

(52) **U.S. Cl.** **D6/479**

(58) **Field of Search** D6/407, 474, 477-479;
 108/59, 64, 91-93, 107, 149, 151, 144.11,
 147.11, 147.13; 211/13.1, 42, 43, 49.1,
 85.26, 134, 187-190, 153, 207; 312/7.2

(56) **References Cited**

U.S. PATENT DOCUMENTS

D184,828 S	*	4/1959	Mitchell	D6/477
5,115,924 A	*	5/1992	Konig	211/187
D489,548 S	*	5/2004	Malizia	D6/477
D491,385 S	*	6/2004	Sexton	D6/479
D491,749 S	*	6/2004	Malizia	D6/474

* cited by examiner

Primary Examiner—Cathron Brooks
(74) Attorney, Agent, or Firm—Townsend and Townsend
 and Crew LLP

(57) **CLAIM**

The ornamental design for an audio-video storage unit, as shown and described.

DESCRIPTION

FIG. 1 is a perspective view of an audio-video storage unit showing my new design;
 FIG. 2 is a top plan view thereof;
 FIG. 3 is a front elevational view thereof;
 FIG. 4 is a right side elevational view thereof;
 FIG. 5 is a left side elevational view thereof;
 FIG. 6 is a rear elevational view thereof;
 FIG. 7 is a bottom plan view thereof
 FIG. 8 is a perspective view of a second embodiment of my new design;
 FIG. 9 is a top plan view thereof;
 FIG. 10 is a front elevational view thereof;
 FIG. 11 is a right side elevational view thereof;
 FIG. 12 is a left side elevational view thereof;
 FIG. 13 is a rear elevational view thereof; and,
 FIG. 14 is a bottom plan view thereof.

1 Claim, 4 Drawing Sheets

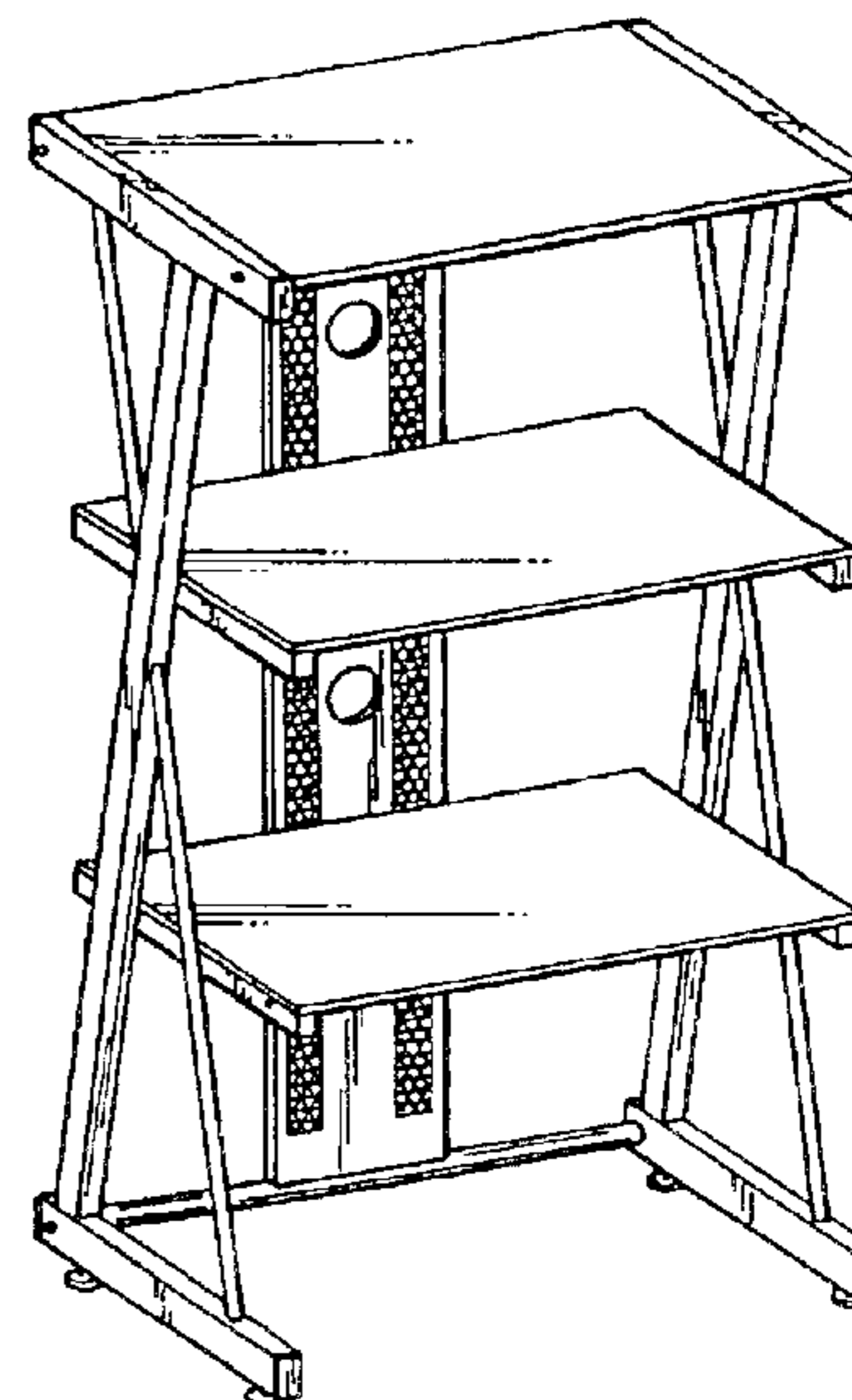
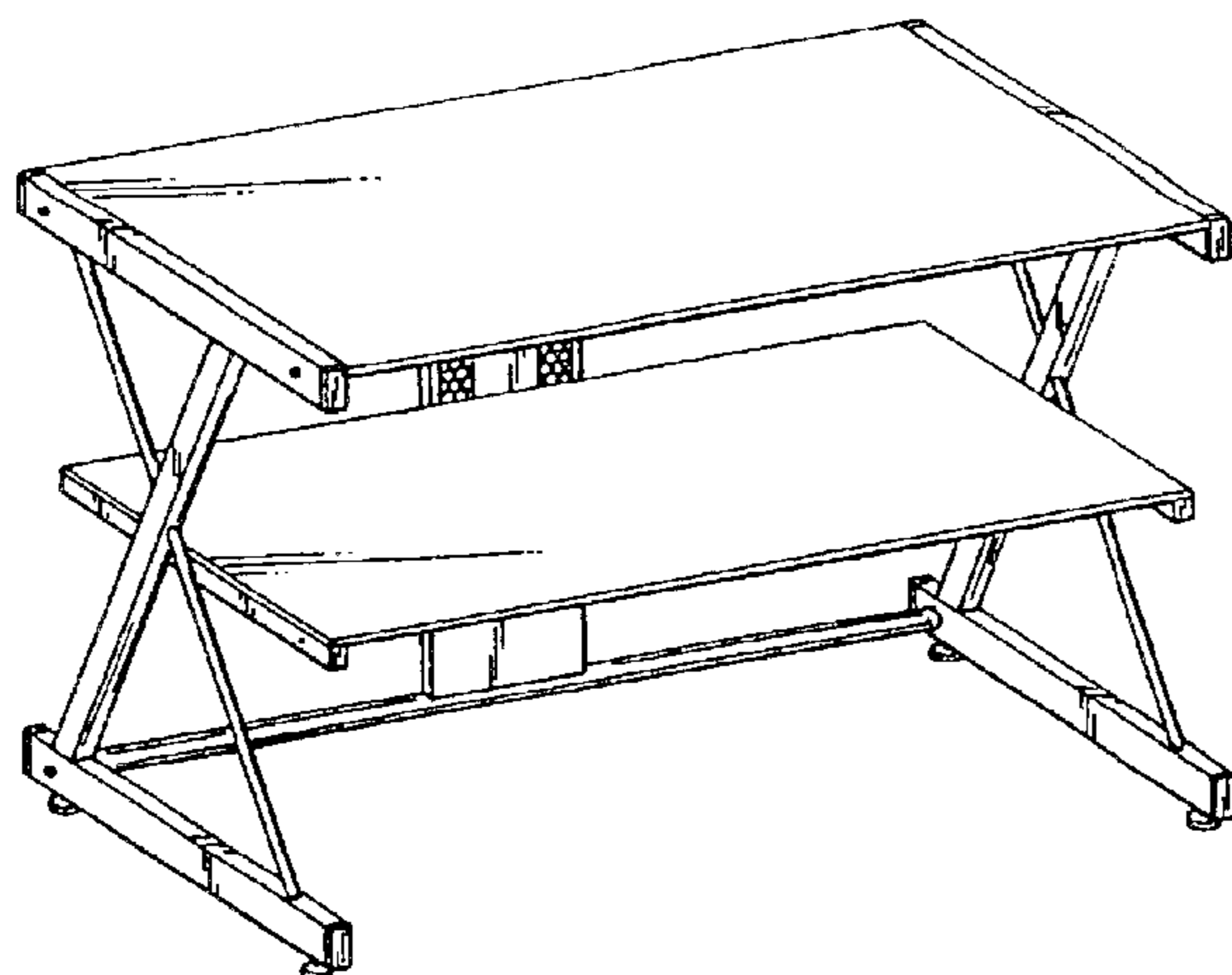

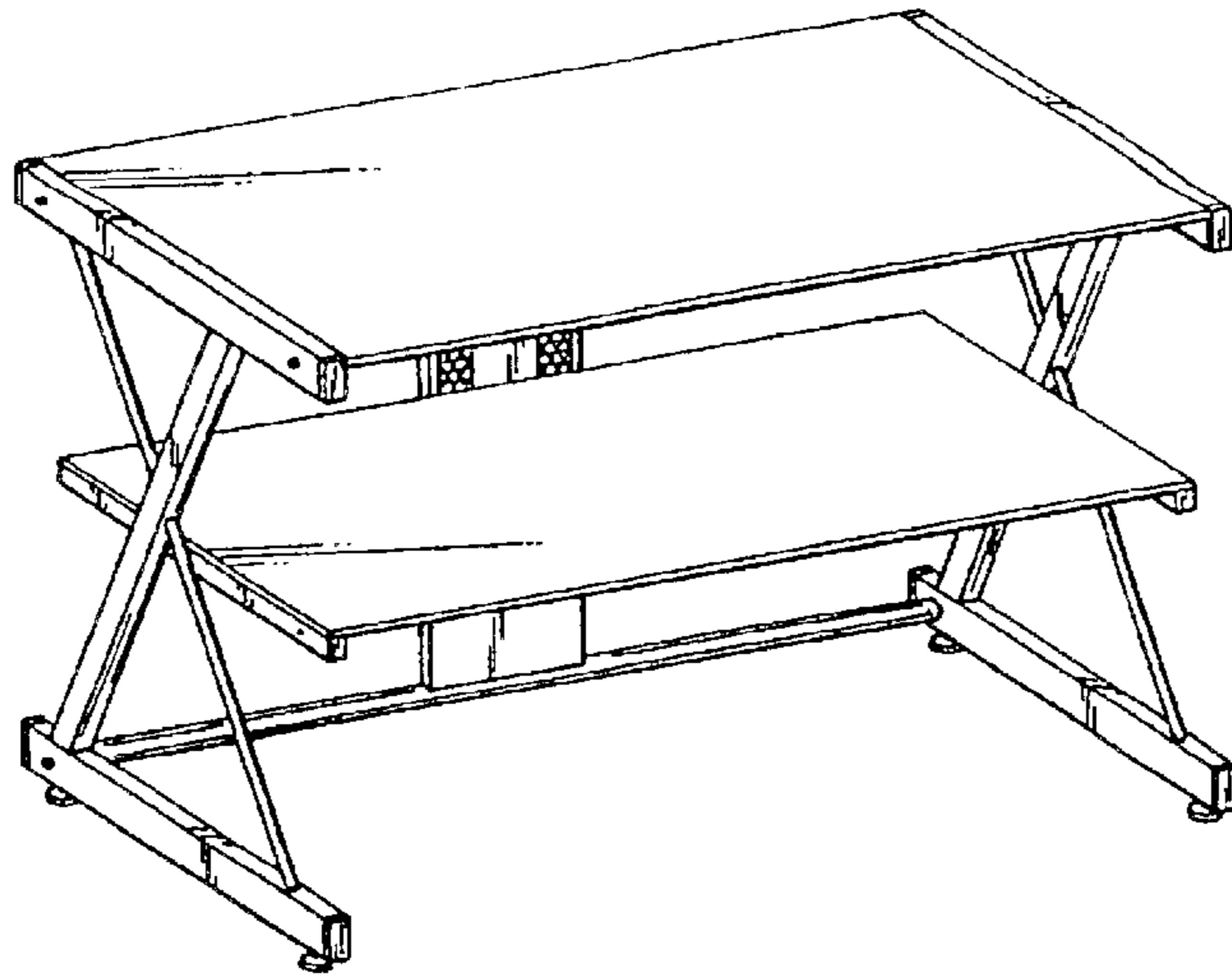

FIG. 1

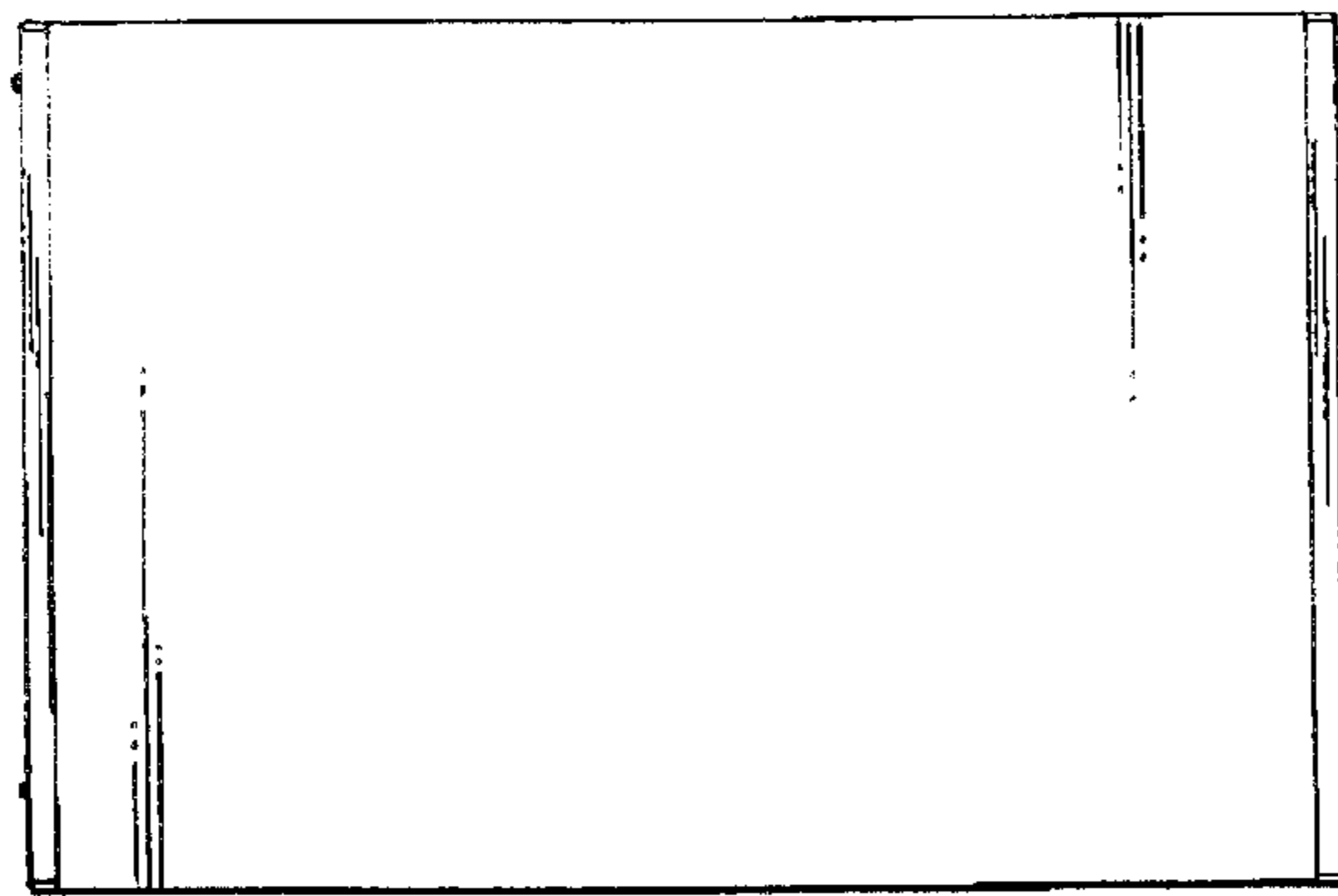

FIG. 2

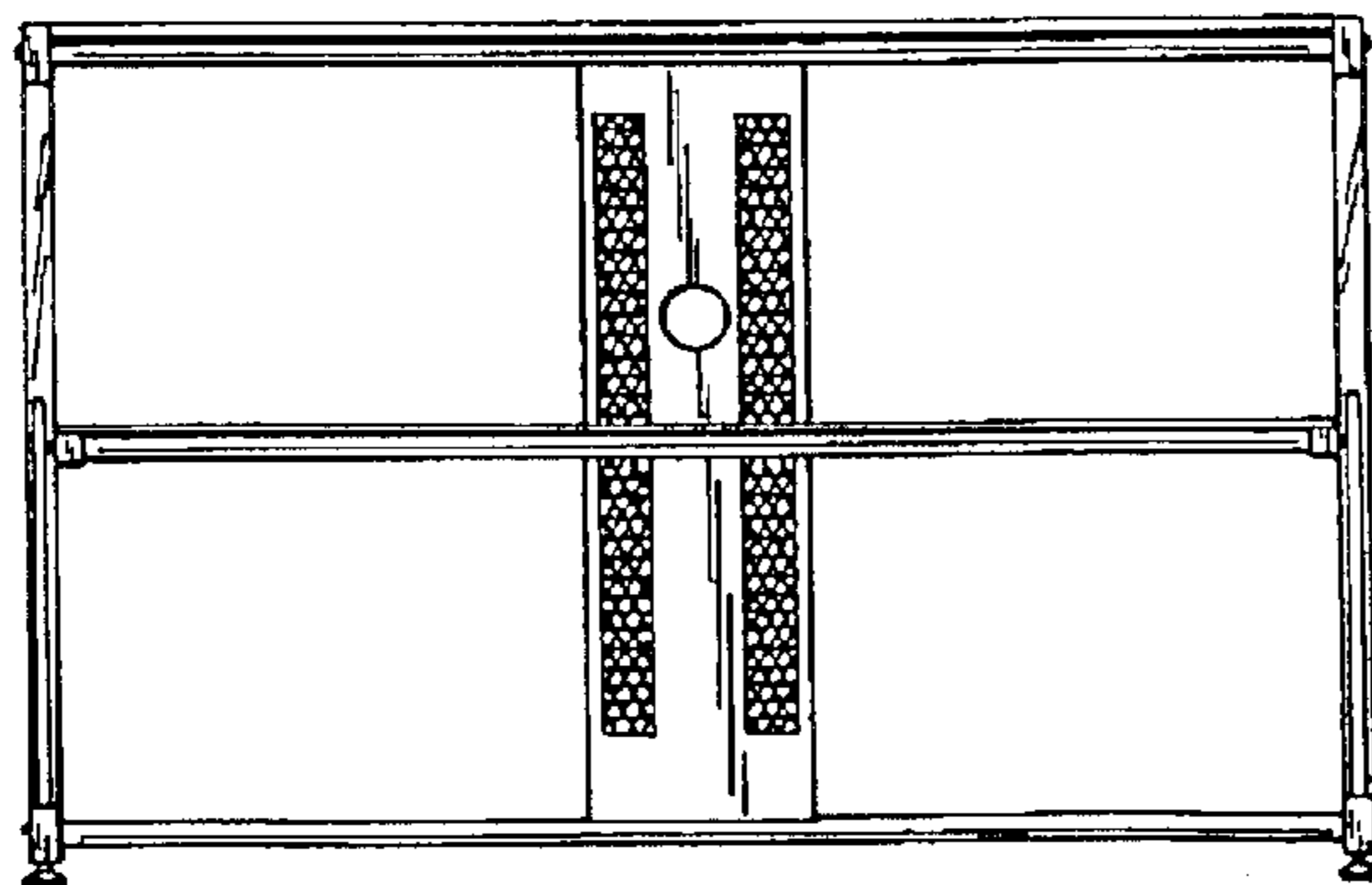

FIG. 3

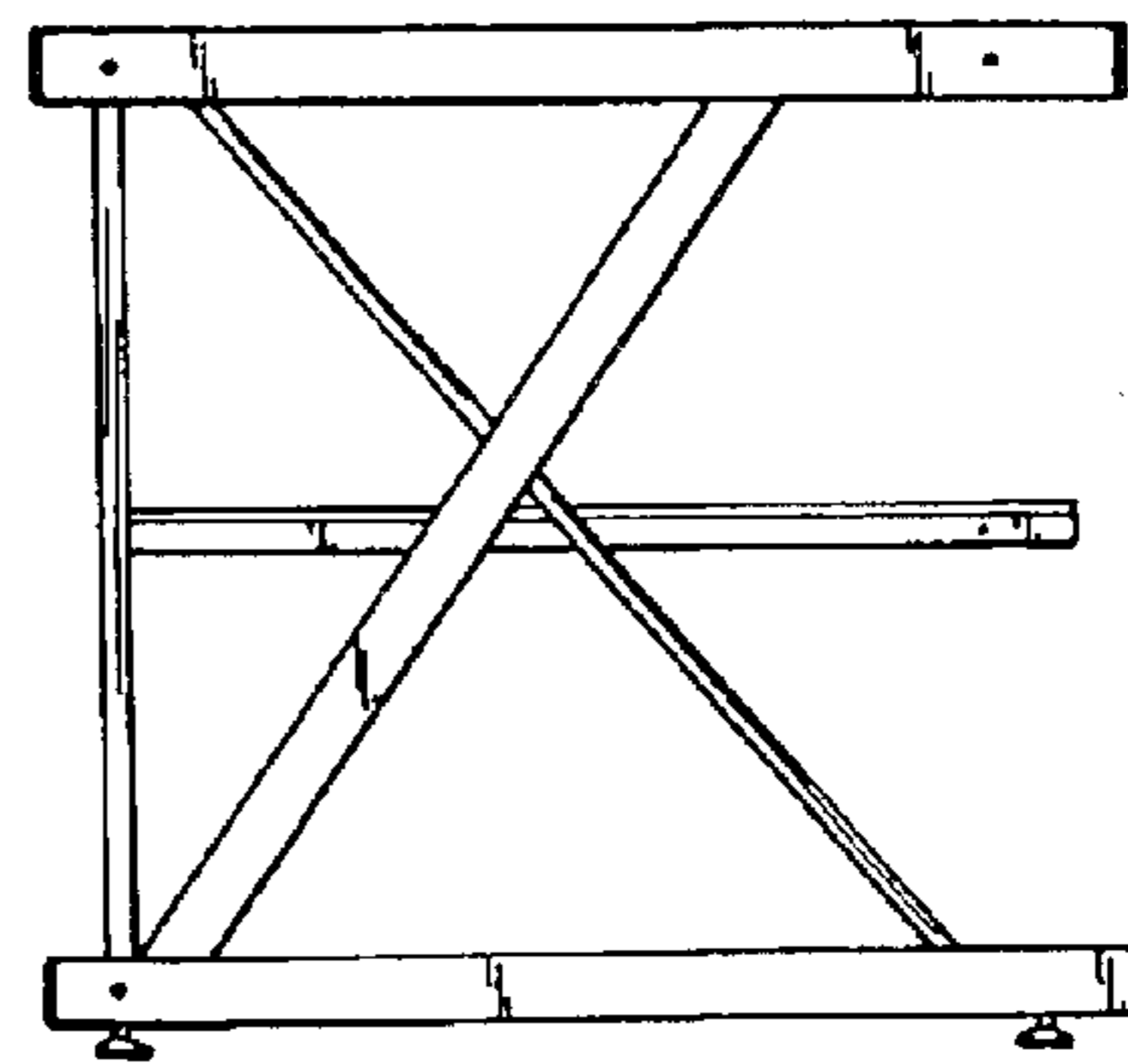

FIG. 4

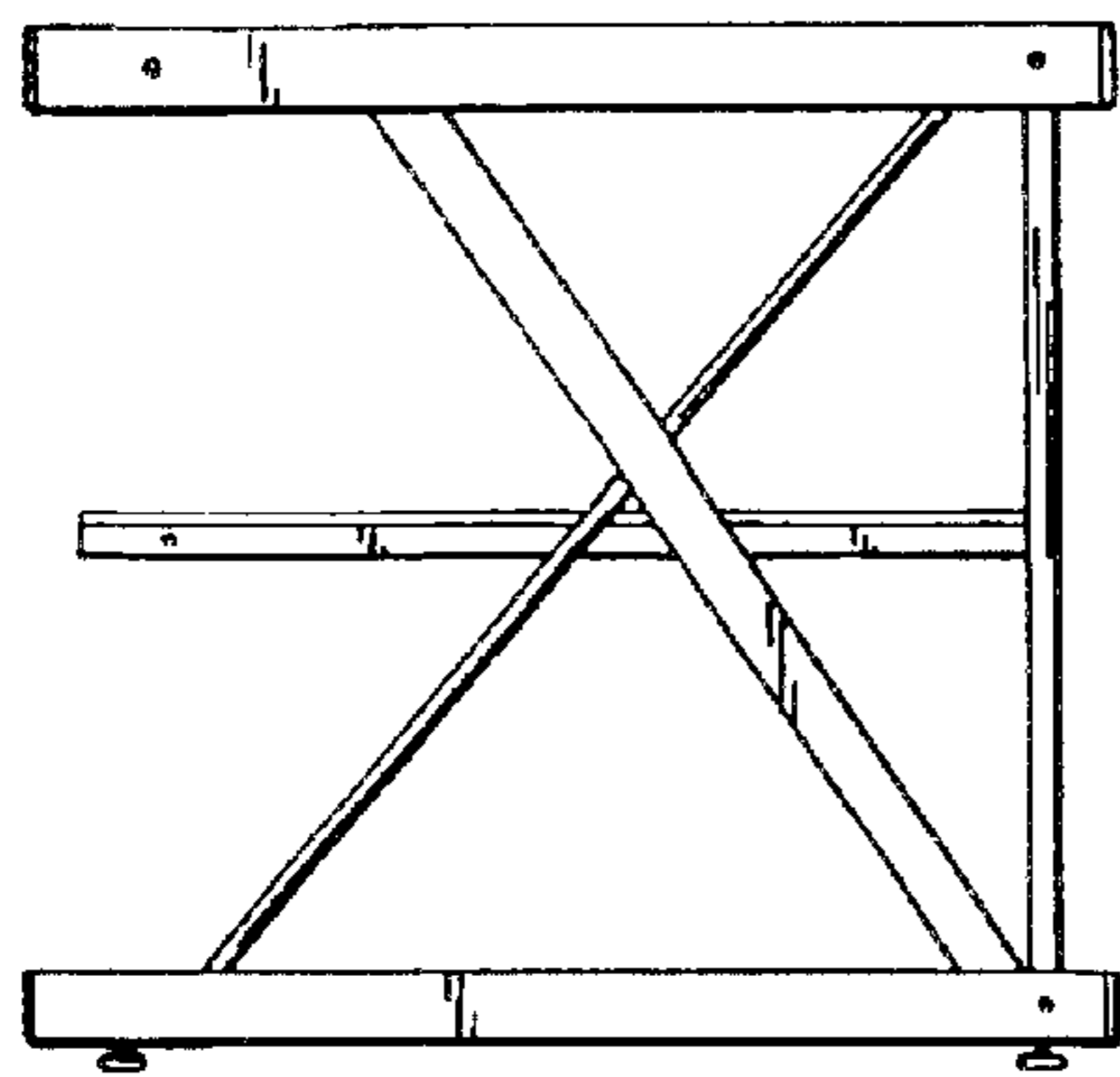

FIG. 5

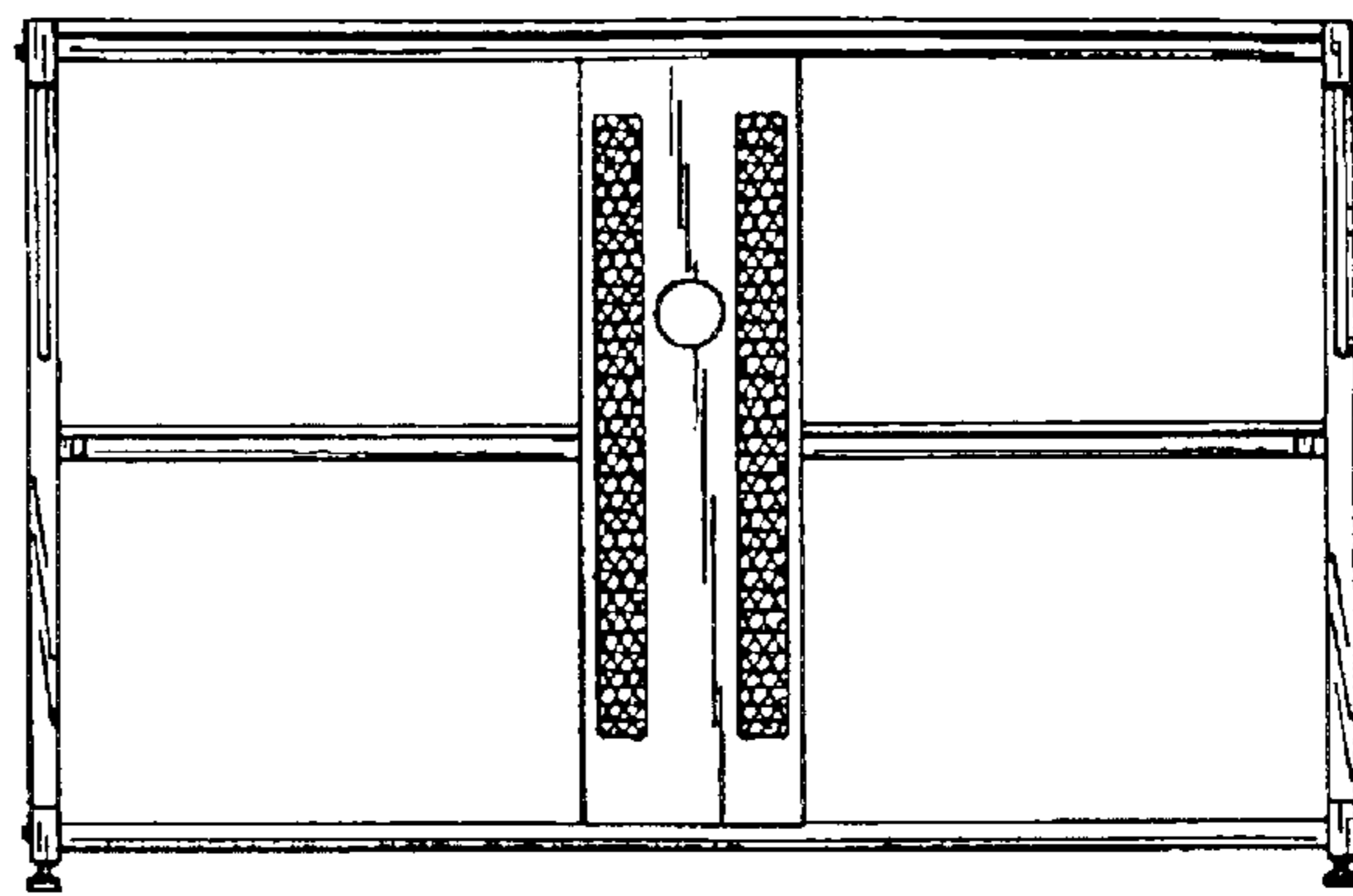

FIG. 6

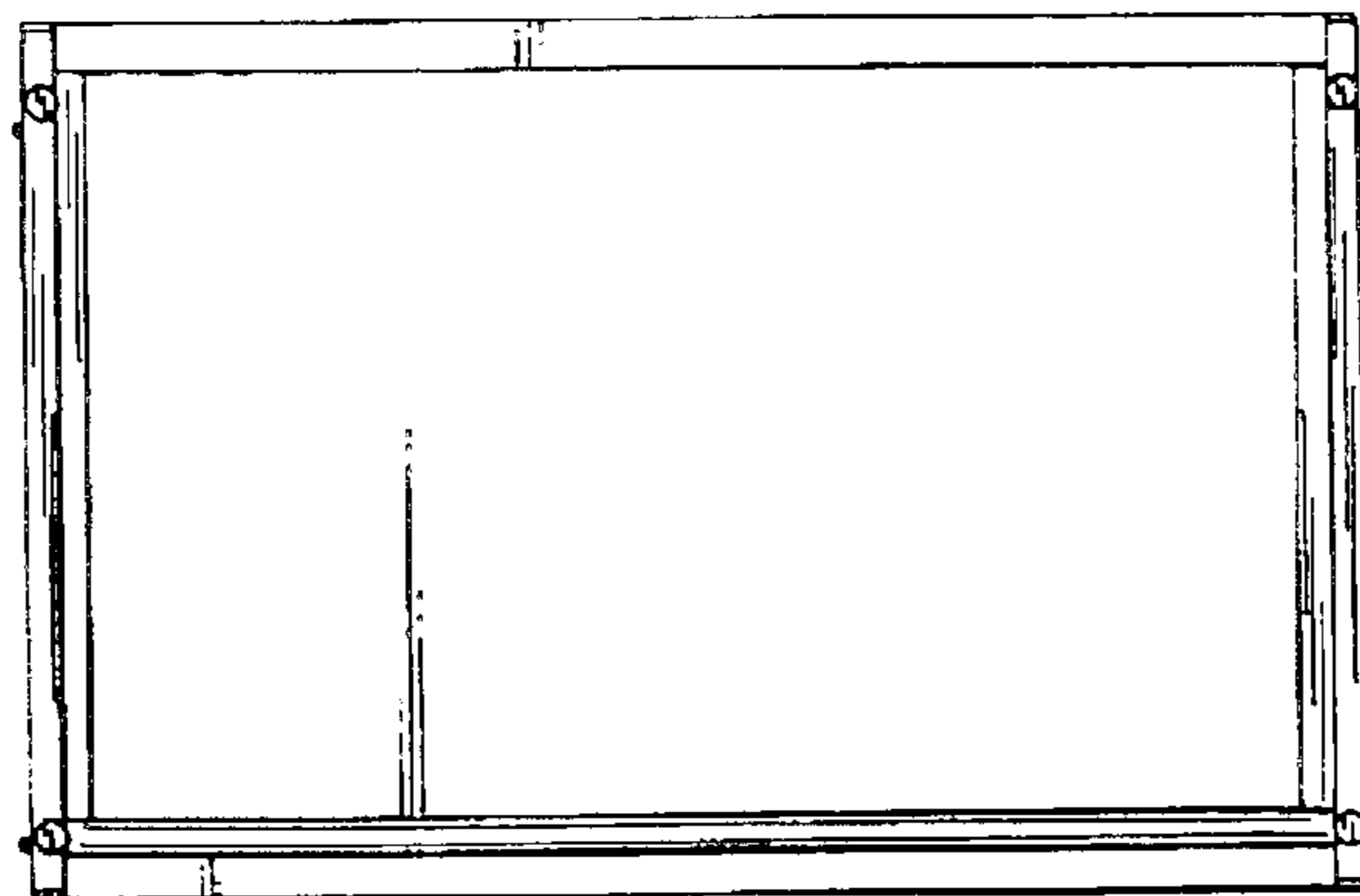

FIG. 7

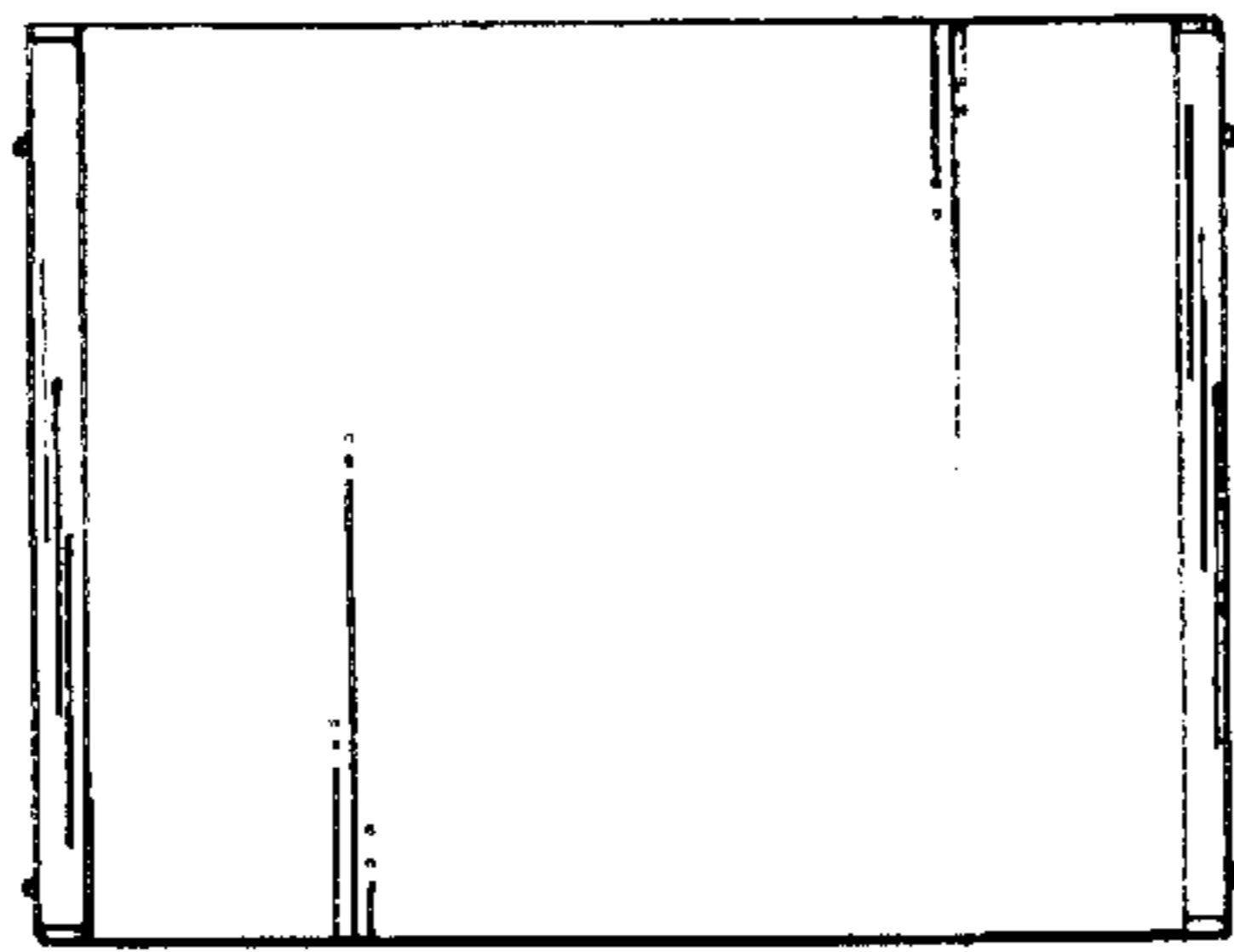

FIG. 9

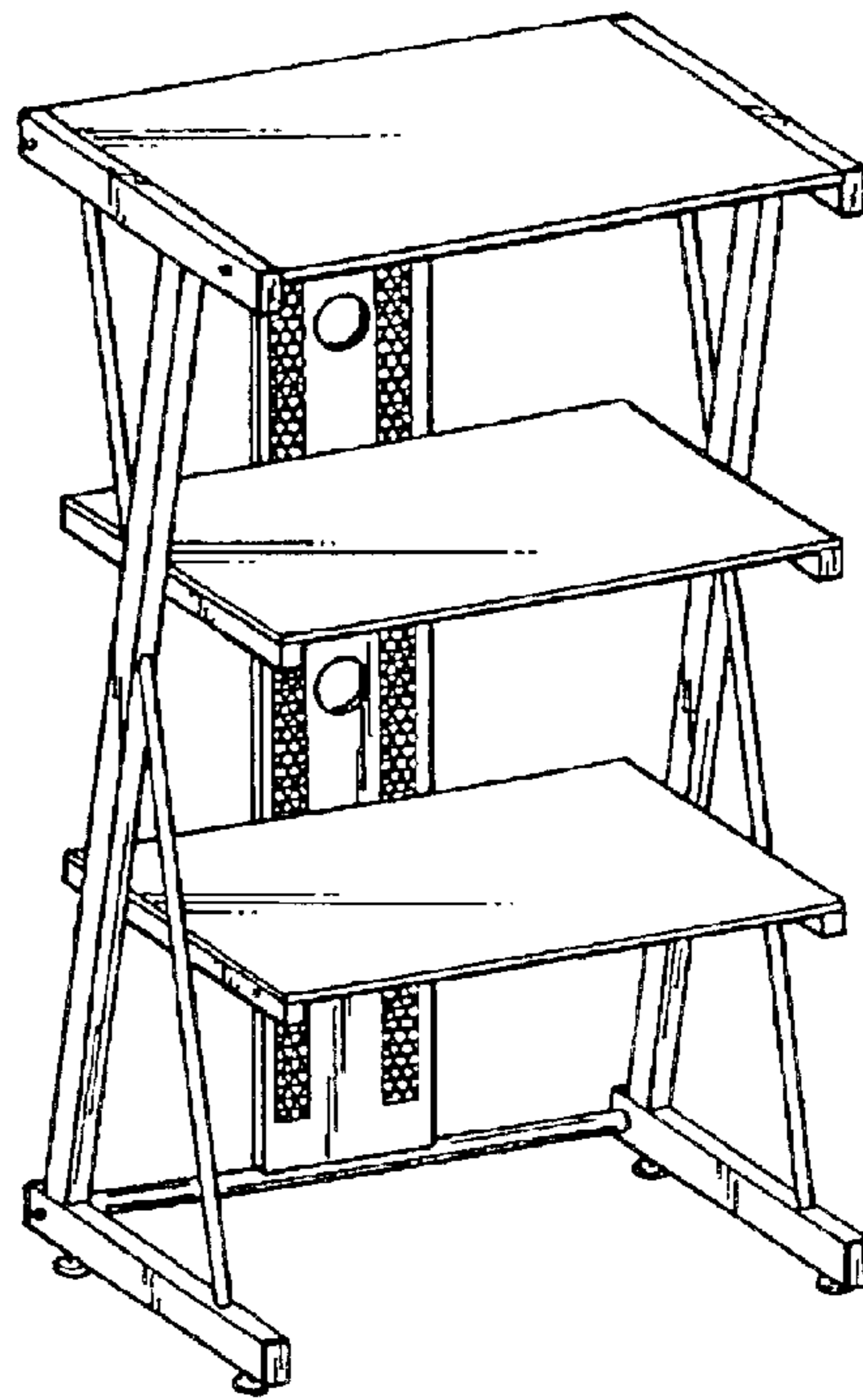

FIG. 8

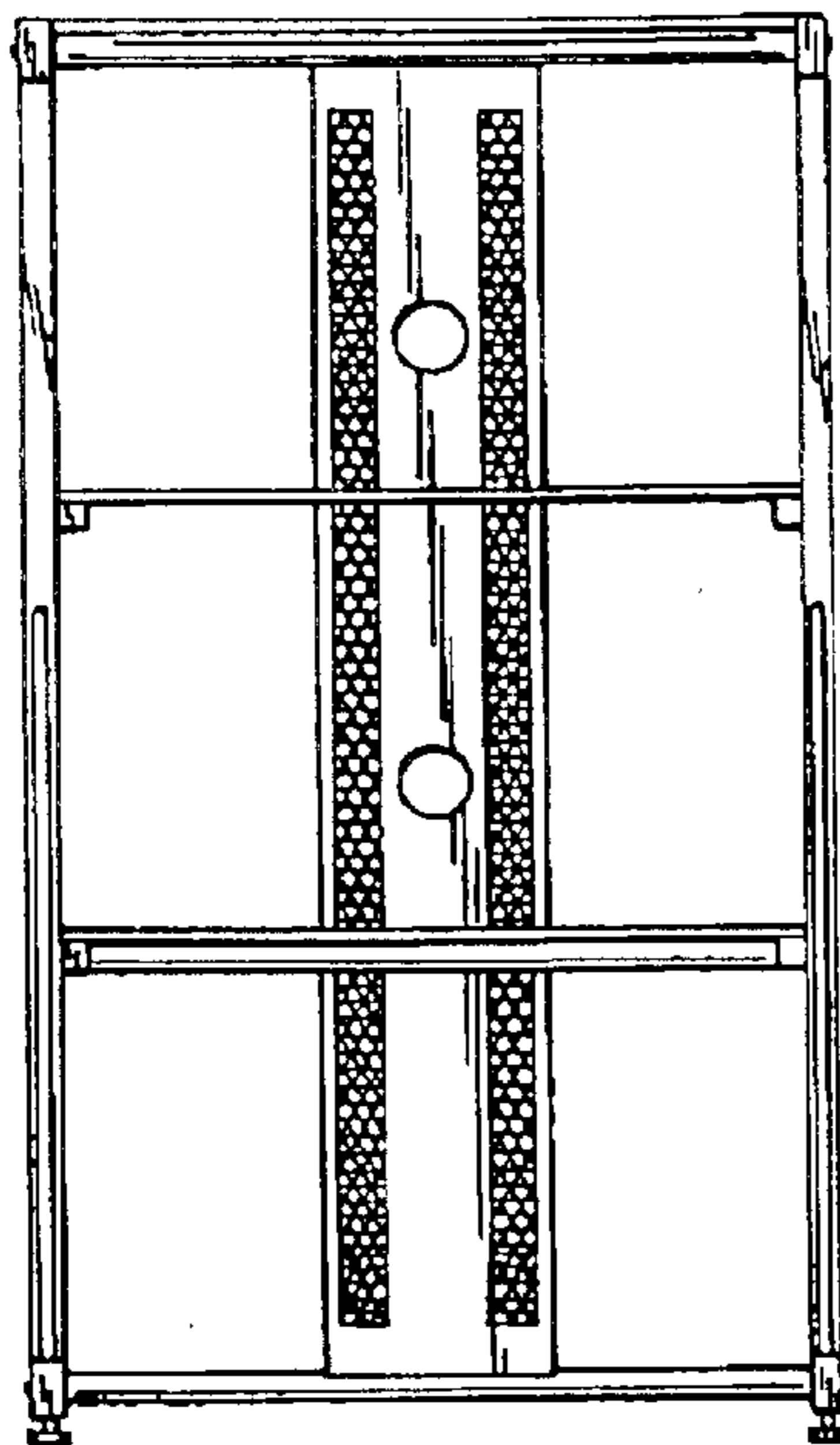

FIG. 10

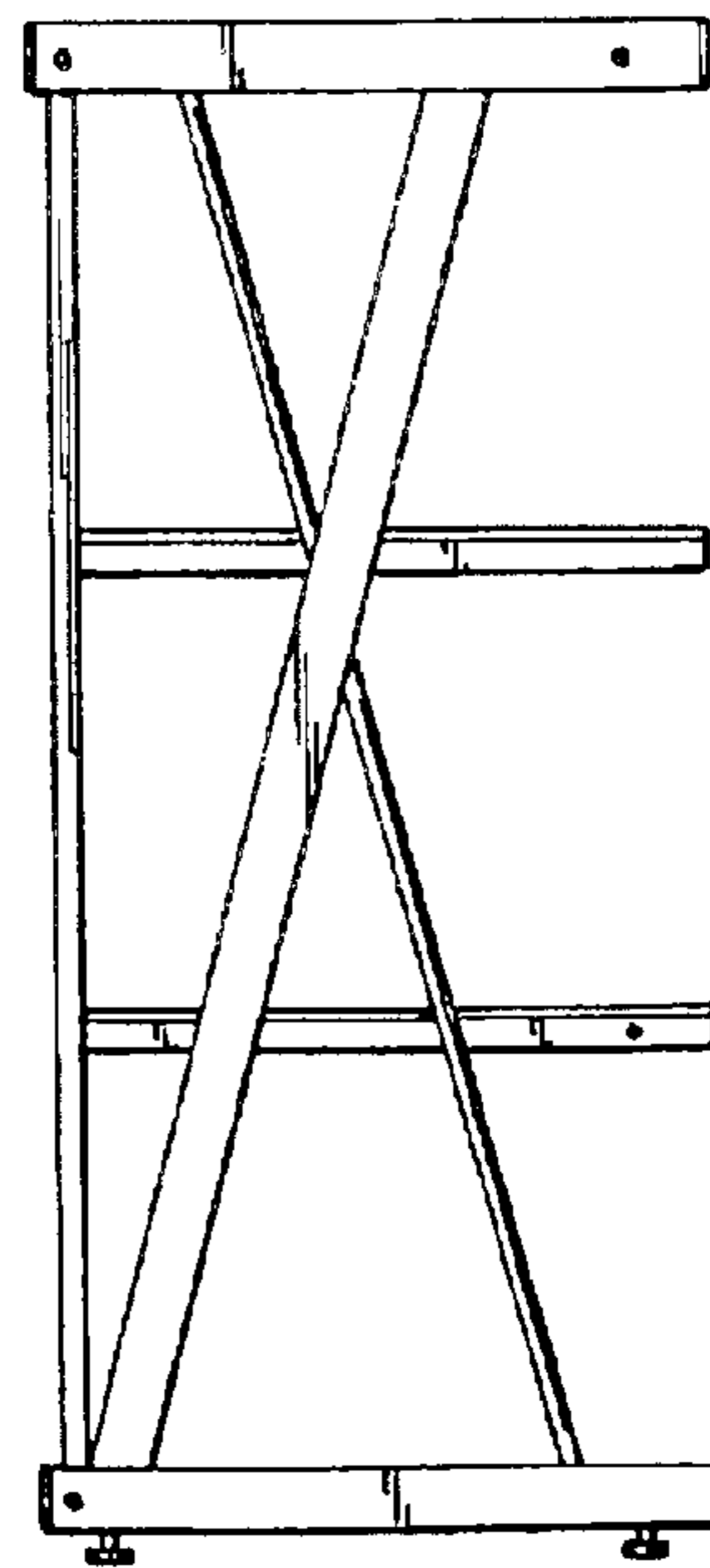

FIG. 11

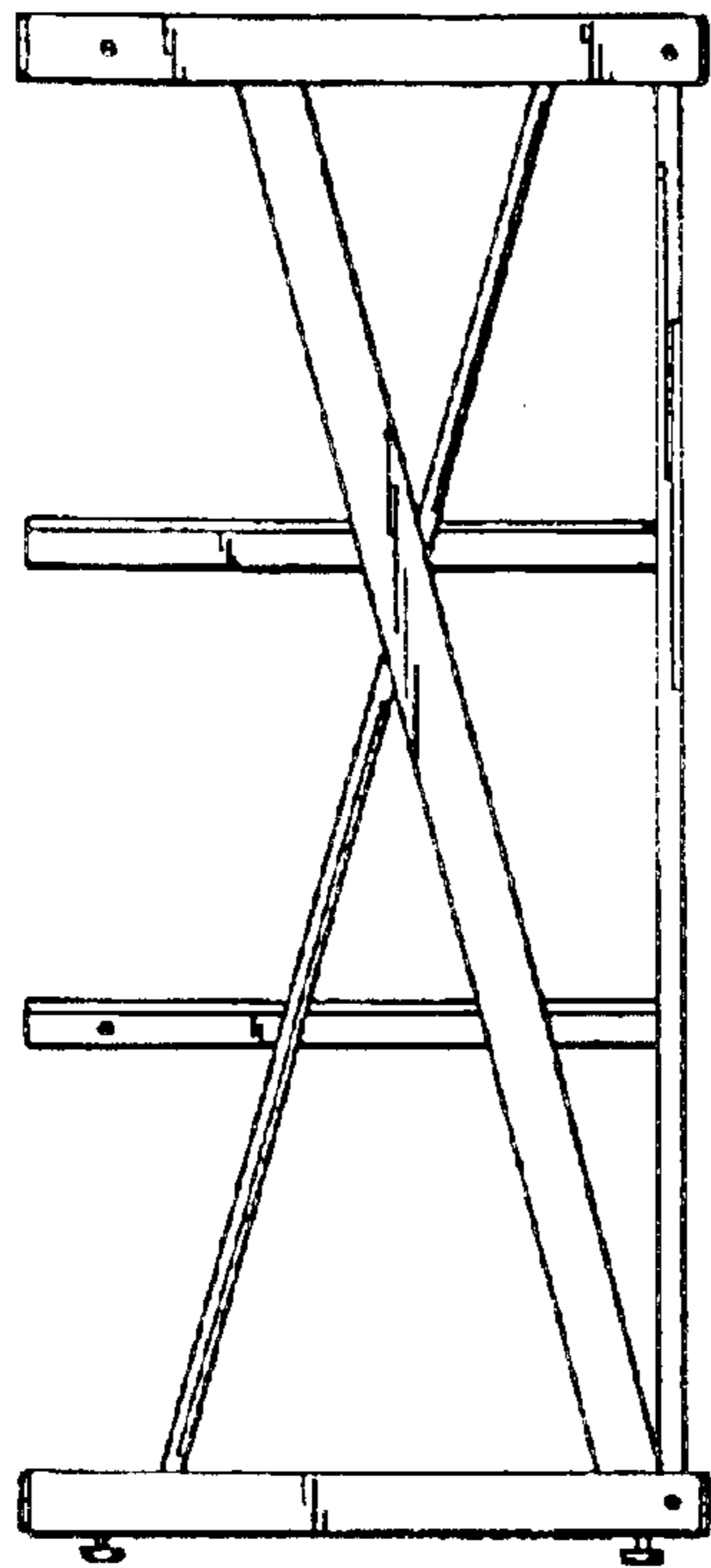

FIG. 12

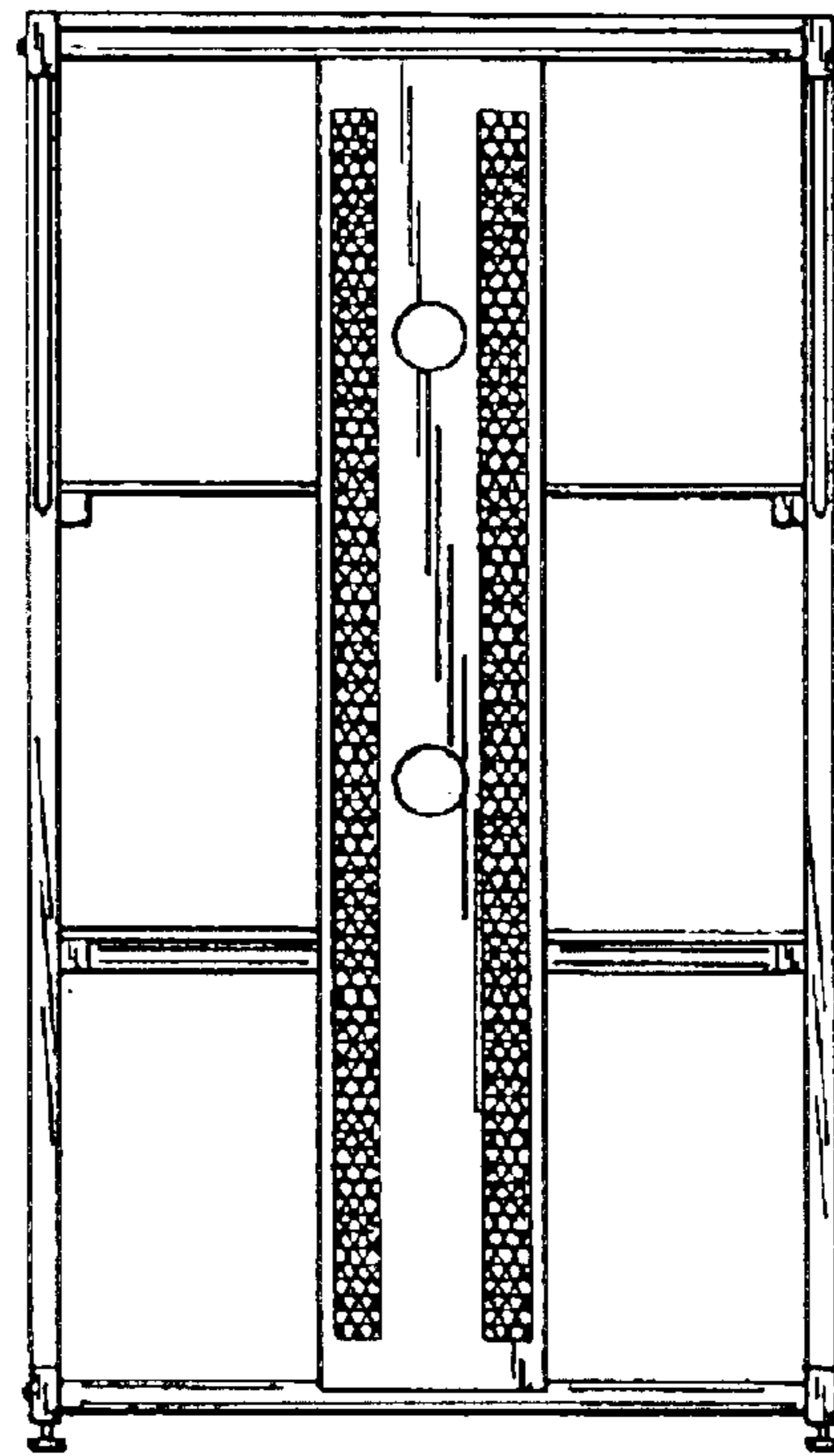

FIG. 13

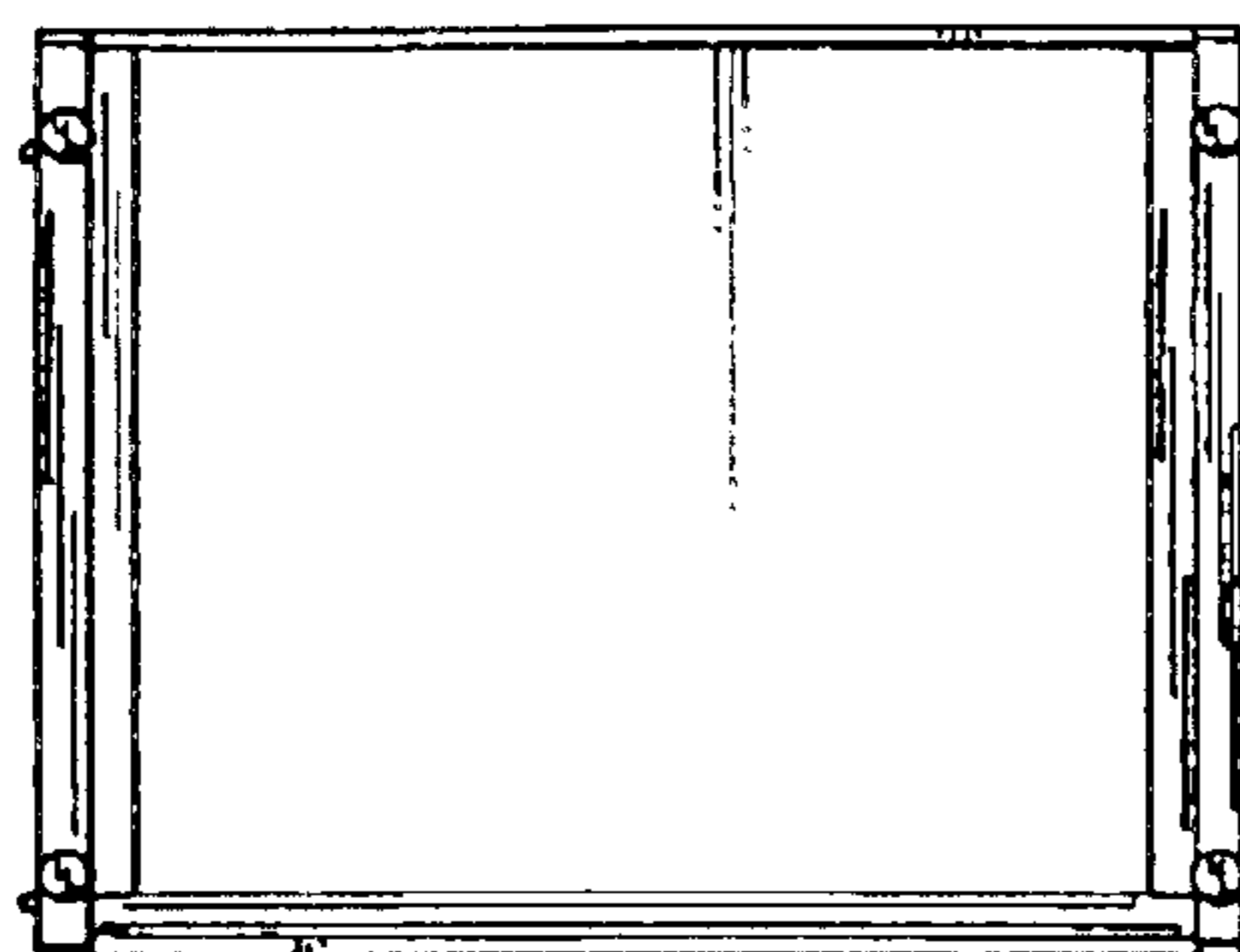

FIG. 14