

US00D497734S1

(12) **United States Design Patent**  
**Nastri**

(10) **Patent No.:** **US D497,734 S**  
(45) **Date of Patent:** **\*\* Nov. 2, 2004**

(54) **SOFA**

(76) **Inventor:** **Giovanni Nastri**, Via Nazionale del  
Giovi 159, Lenate sul Seveso, Milano  
(IT)

(\*\*) **Term:** **14 Years**

(21) **Appl. No.:** **29/200,944**

(22) **Filed:** **Mar. 8, 2004**

(30) **Foreign Application Priority Data**

Jan. 8, 2004 (IT) ..... MI2004O0004

(51) **LOC (7) Cl.** ..... **06-01**

(52) **U.S. Cl.** ..... **D6/381**

(58) **Field of Search** ..... D6/334, 335, 336,  
D6/371, 373, 381, 500, 501, 502; 5/12.1;  
297/232, 445.1

(56) **References Cited**

**U.S. PATENT DOCUMENTS**

D204,755 S \* 5/1966 Wilson ..... D6/381  
D282,888 S \* 3/1986 Williams ..... D6/381

D291,167 S \* 8/1987 Forbicini ..... D6/381  
D291,847 S \* 9/1987 Salvati ..... D6/381  
D426,397 S \* 6/2000 Nicoletti ..... D6/381  
D471,731 S \* 3/2003 Nicoletti ..... D6/381  
D476,496 S \* 7/2003 Nicoletti ..... D6/381

\* cited by examiner

*Primary Examiner*—Gary D. Watson

(74) *Attorney, Agent, or Firm*—Hedman & Costigan, P.C.

(57) **CLAIM**

The ornamental design for a sofa, as shown and described.

**DESCRIPTION**

FIG. 1 is a front perspective view of an embodiment of a sofa according to the invention;  
FIG. 2 is a front view of a sofa according to the invention;  
FIG. 3 is a back view of the sofa;  
FIG. 4 is a left side view of the sofa;  
FIG. 5 is a right side view of the sofa;  
FIG. 6 is a top view of the sofa; and,  
FIG. 7 is a bottom view of the sofa.

**1 Claim, 4 Drawing Sheets**

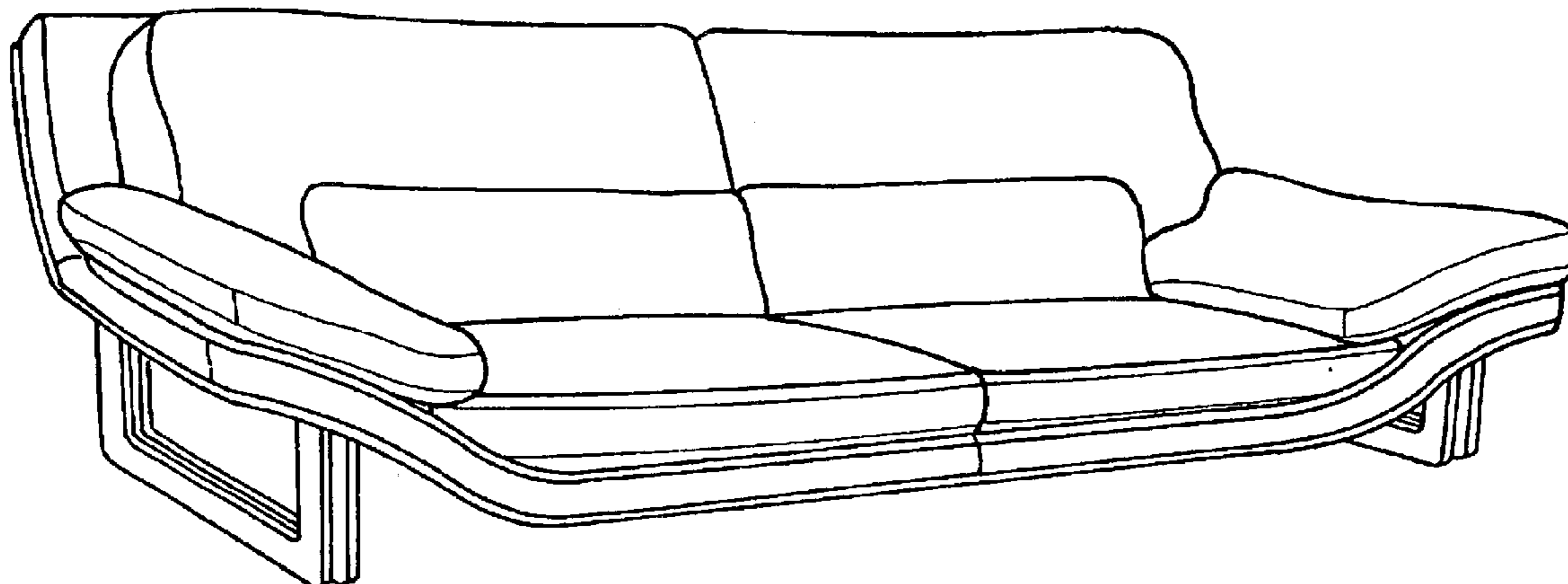

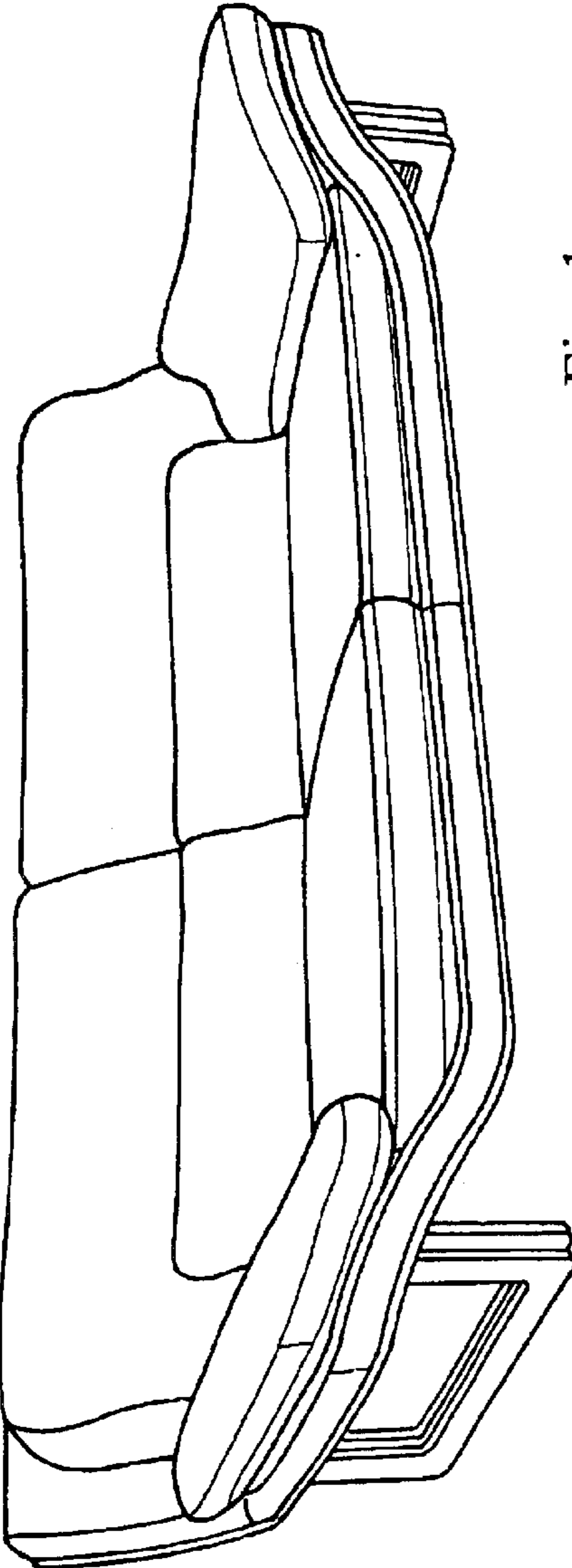

Fig. 1

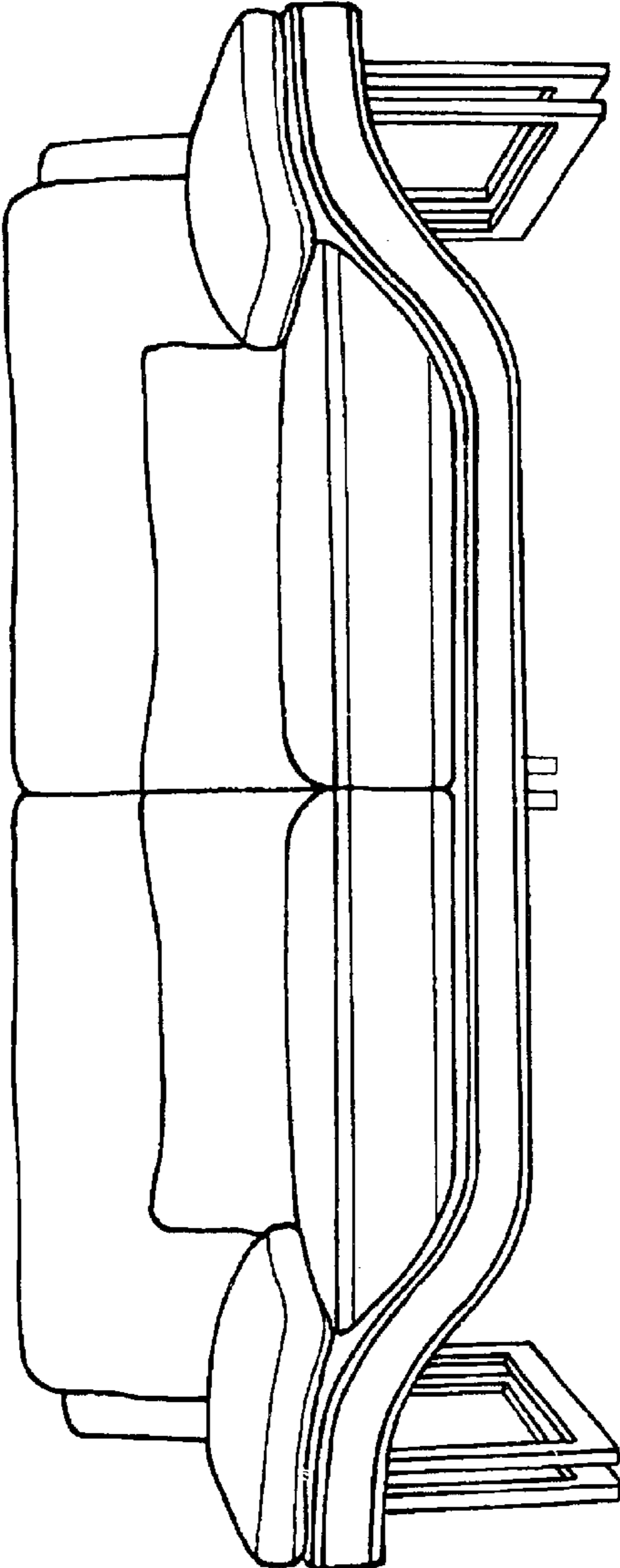

Fig. 2

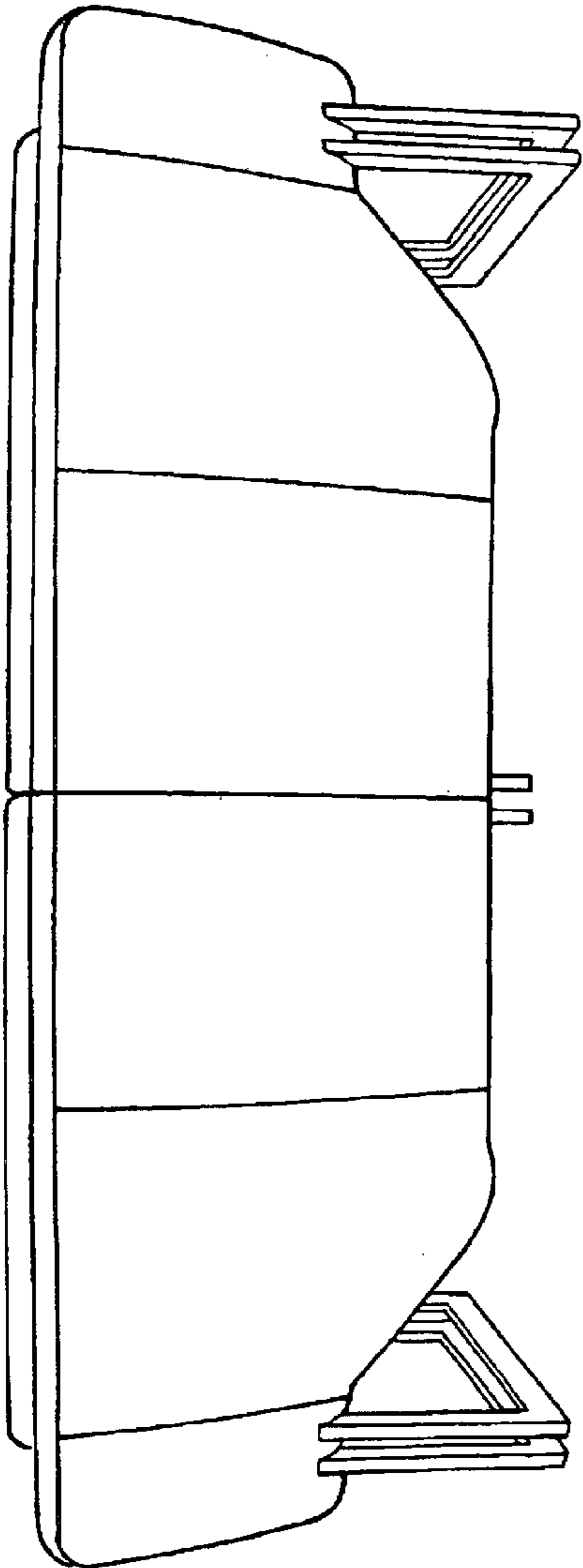

Fig. 3

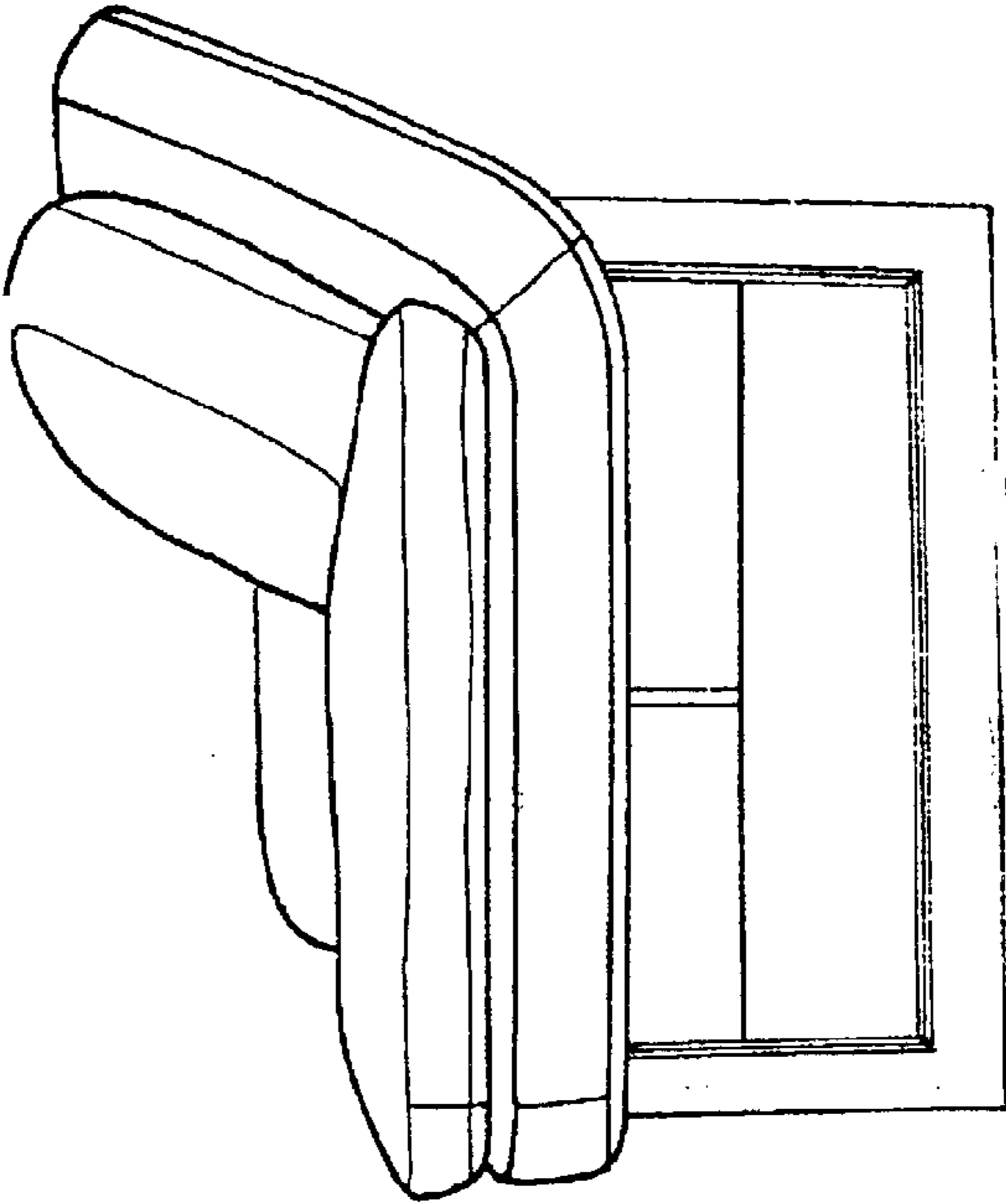

Fig. 5

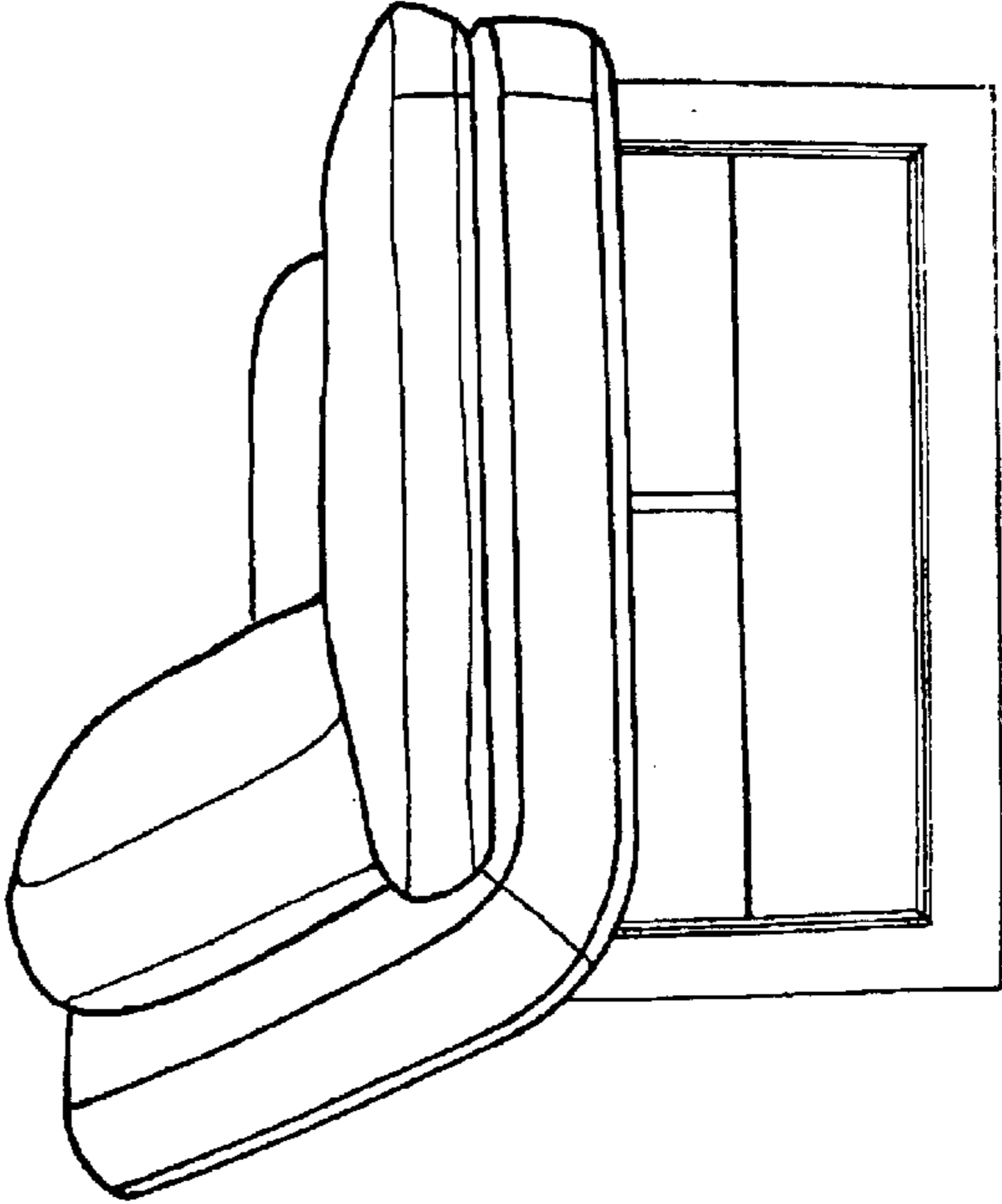

Fig. 4

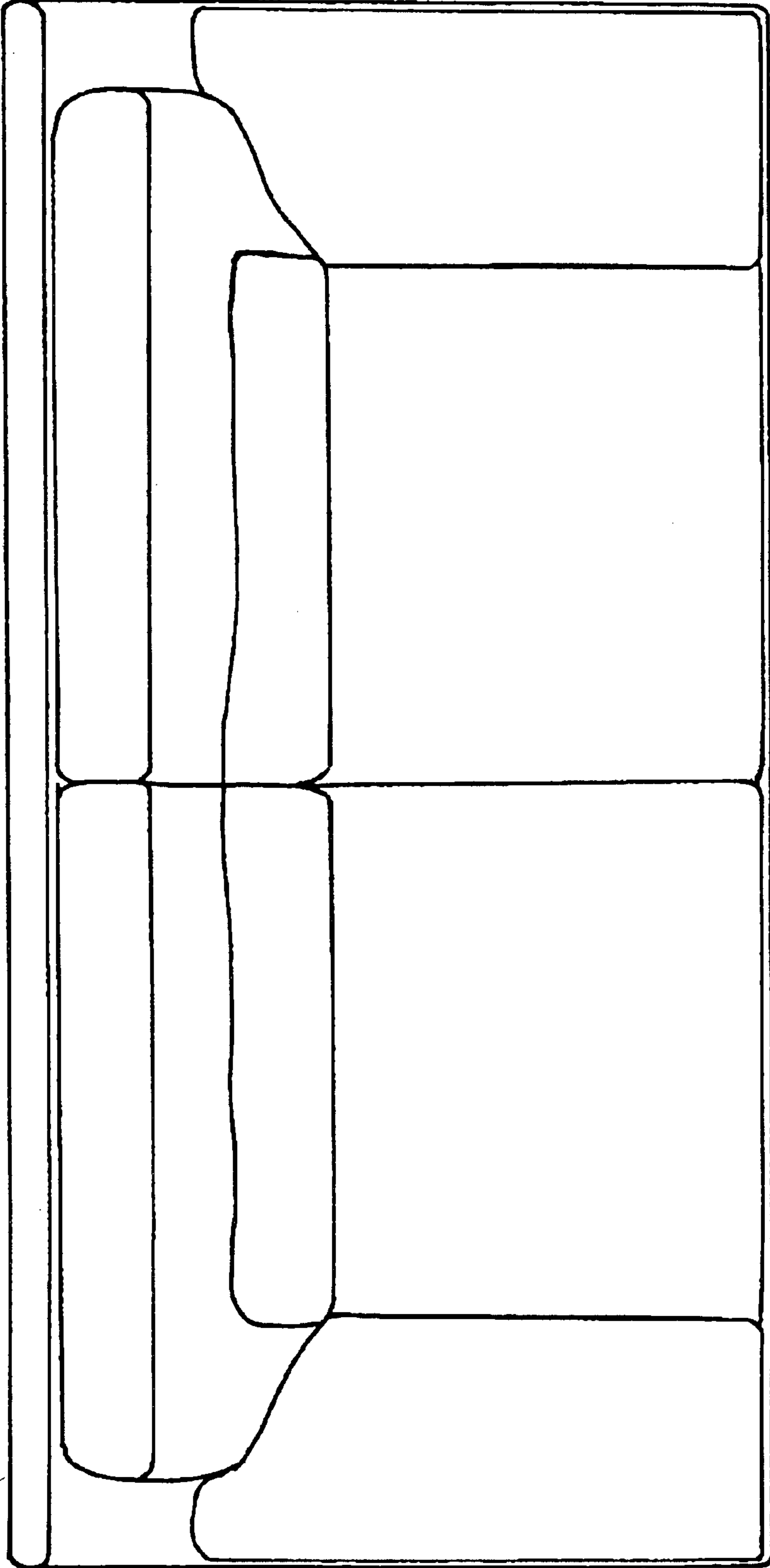

Fig. 6

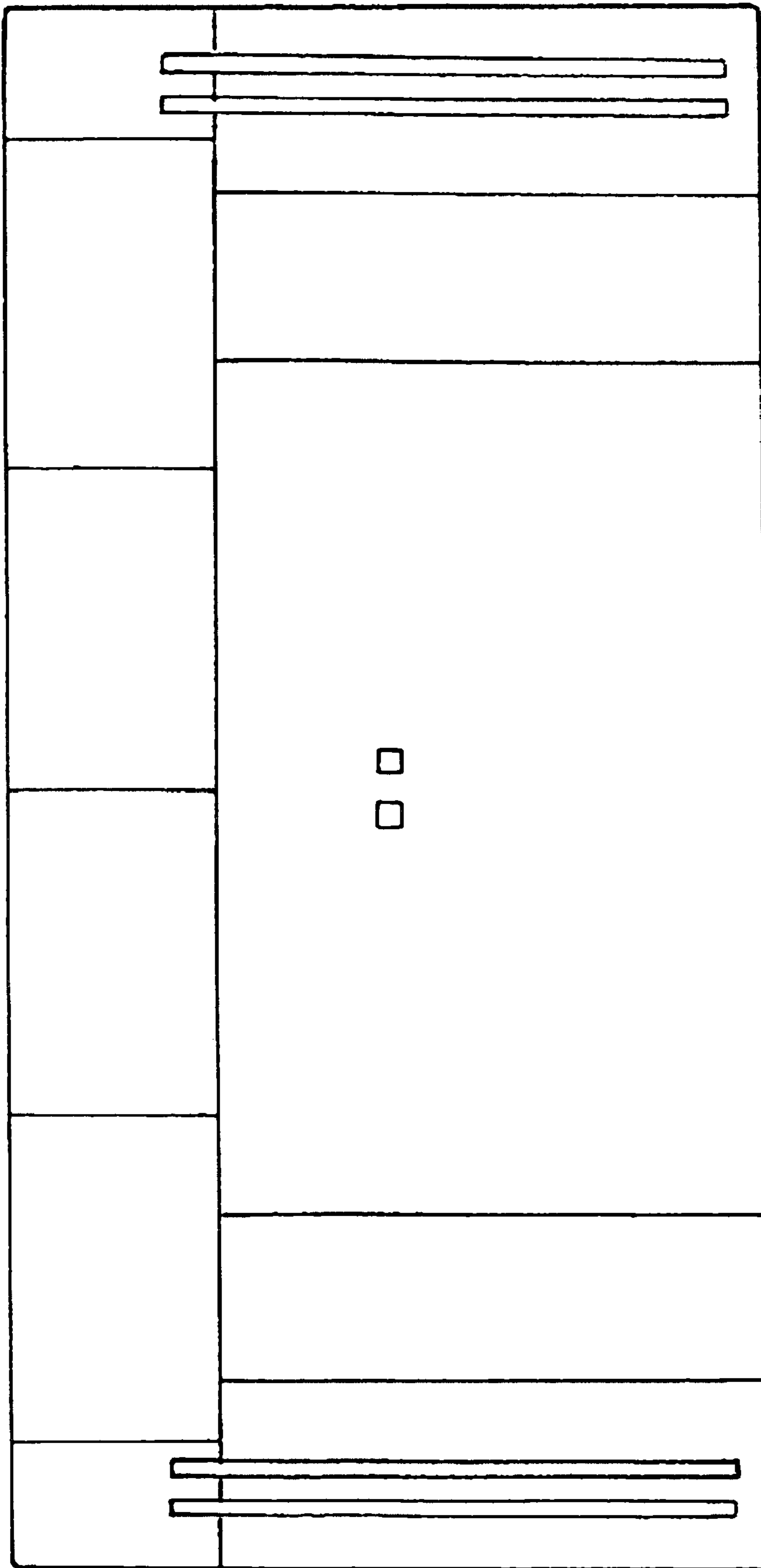

Fig. 7

UNITED STATES PATENT AND TRADEMARK OFFICE  
**CERTIFICATE OF CORRECTION**

PATENT NO. : Des. 497,734 S  
DATED : November 2, 2004  
INVENTOR(S) : Giovanni Nastri

Page 1 of 1

It is certified that error appears in the above-identified patent and that said Letters Patent is hereby corrected as shown below:

Title page,  
Item [76], Inventor, the correct residence of the inventor is -- Lentate sul Seveso -  
Milano, Italy --

Signed and Sealed this

Ninth Day of August, 2005

A handwritten signature in black ink on a light gray dotted background. The signature reads "Jon W. Dudas" in a cursive style.

JON W. DUDAS

*Director of the United States Patent and Trademark Office*