

US00D497647S1

(12) **United States Design Patent**  
**Okupe**

(10) **Patent No.:** **US D497,647 S**

(45) **Date of Patent:** **\*\* Oct. 26, 2004**

(54) **GUMBALL DISPENSER AND DISPLAY**

D333,681 S 3/1993 Stern ..... D20/7  
D387,386 S \* 12/1997 Tegtmeier et al. .... D20/7  
5,984,171 A \* 11/1999 Schwarzli ..... 232/15

(76) Inventor: **Olukoya Olugbenga Okupe**, 2643  
McCloud River Rd., Stockton, CA (US)  
95206

\* cited by examiner

(\*\*) Term: **14 Years**

*Primary Examiner*—Robert M. Spear  
(74) *Attorney, Agent, or Firm*—Goldstein Law Offices, P.C.

(21) Appl. No.: **29/187,080**

(57) **CLAIM**

(22) Filed: **Jul. 25, 2003**

The ornamental design for a gumball dispenser and display, as shown and described.

(51) **LOC (7) Cl.** ..... **20-01**

(52) **U.S. Cl.** ..... **D20/7**

(58) **Field of Search** ..... D20/1-9; 194/239,  
194/320, 342, 350; 221/92, 128, 155, 191,  
194, 284; 463/17; D6/515; D19/67

**DESCRIPTION**

FIG. 1 is a perspective view of a gumball dispenser and display in full lines with gumballs shown in broken lines representing environmental association matter being for illustrative purposes only and forming no part of the claimed invention.

FIG. 2 is a front elevational view thereof.

FIG. 3 is a rear elevational view thereof.

FIG. 4 is a right side elevational view thereof.

FIG. 5 is a left side elevational view thereof.

FIG. 6 is a top plan view thereof.

FIG. 7 is a bottom plan view thereof; and,

FIG. 8 is a perspective view of the gumball dispenser and display in full lines with a stand shown in broken lines representing environmental association matter being for illustrative purposes only and forming no part of the claimed invention.

(56) **References Cited**

**U.S. PATENT DOCUMENTS**

D36,786 S	2/1904	Nichols	
D39,257 S	* 4/1908	Davis	D20/7
D49,333 S	7/1916	Giles	
1,540,389 A	6/1925	Felton	
1,706,324 A	3/1929	Rogers	
1,864,847 A	6/1932	Morrison	
D206,611 S	* 1/1967	Christine et al.	D20/4
3,489,259 A	1/1970	Greenwald et al.	194/92
3,602,351 A	8/1971	Terry	194/55
D264,593 S	* 5/1982	Lyons	D7/589
D264,596 S	* 5/1982	Lyons	D7/589
D277,633 S	2/1985	McClellan	D7/76

**1 Claim, 6 Drawing Sheets**

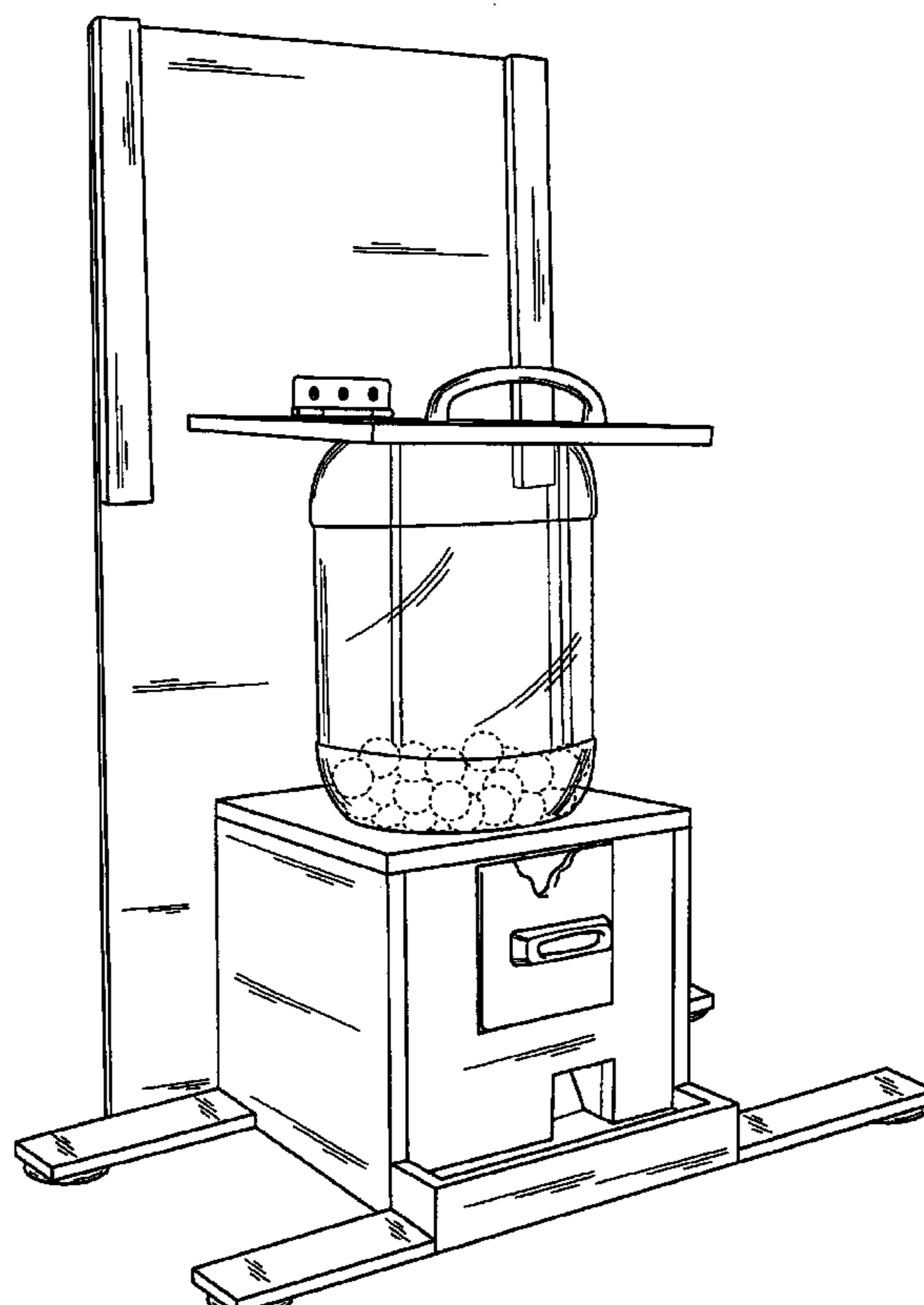

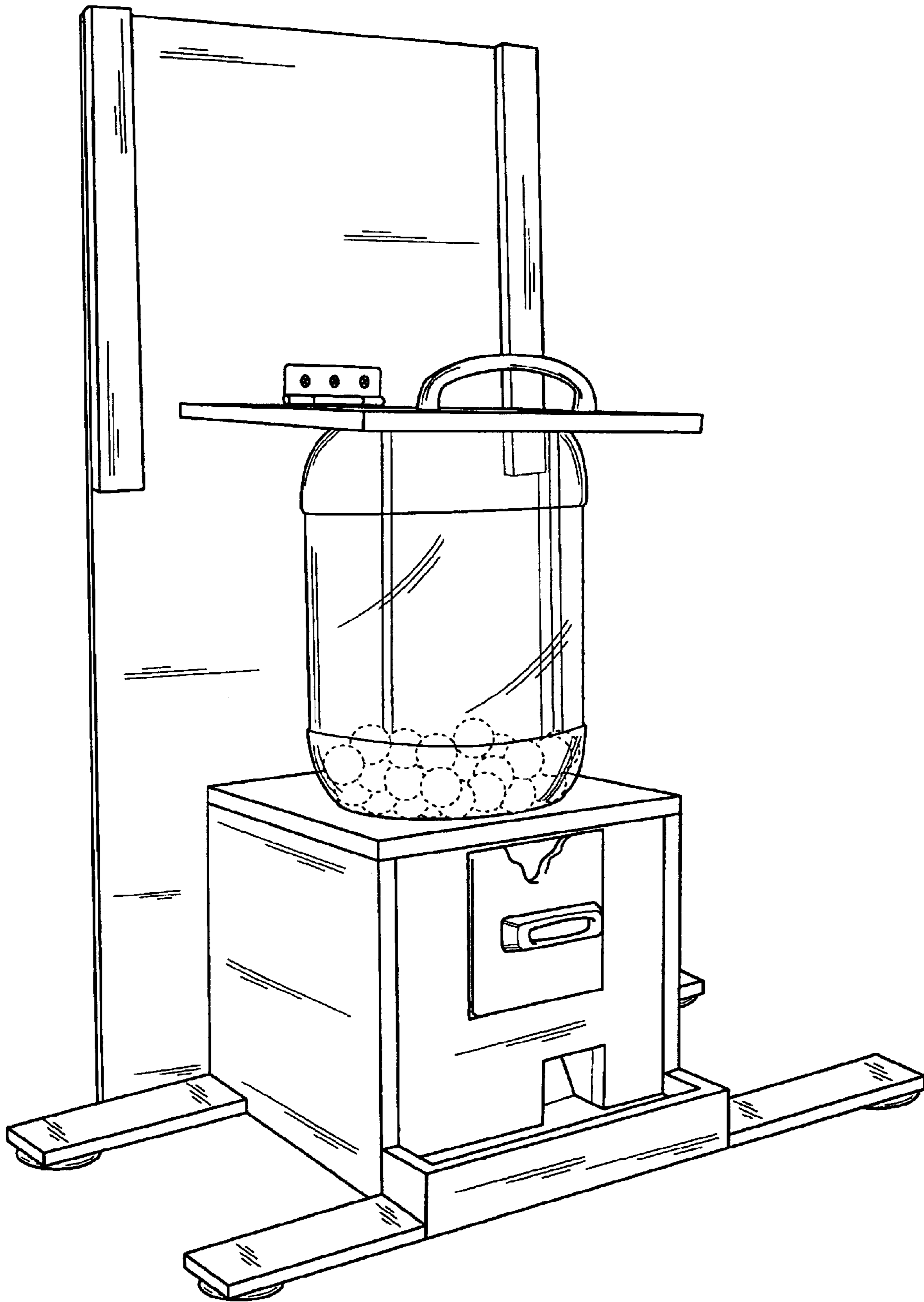

FIG. 1

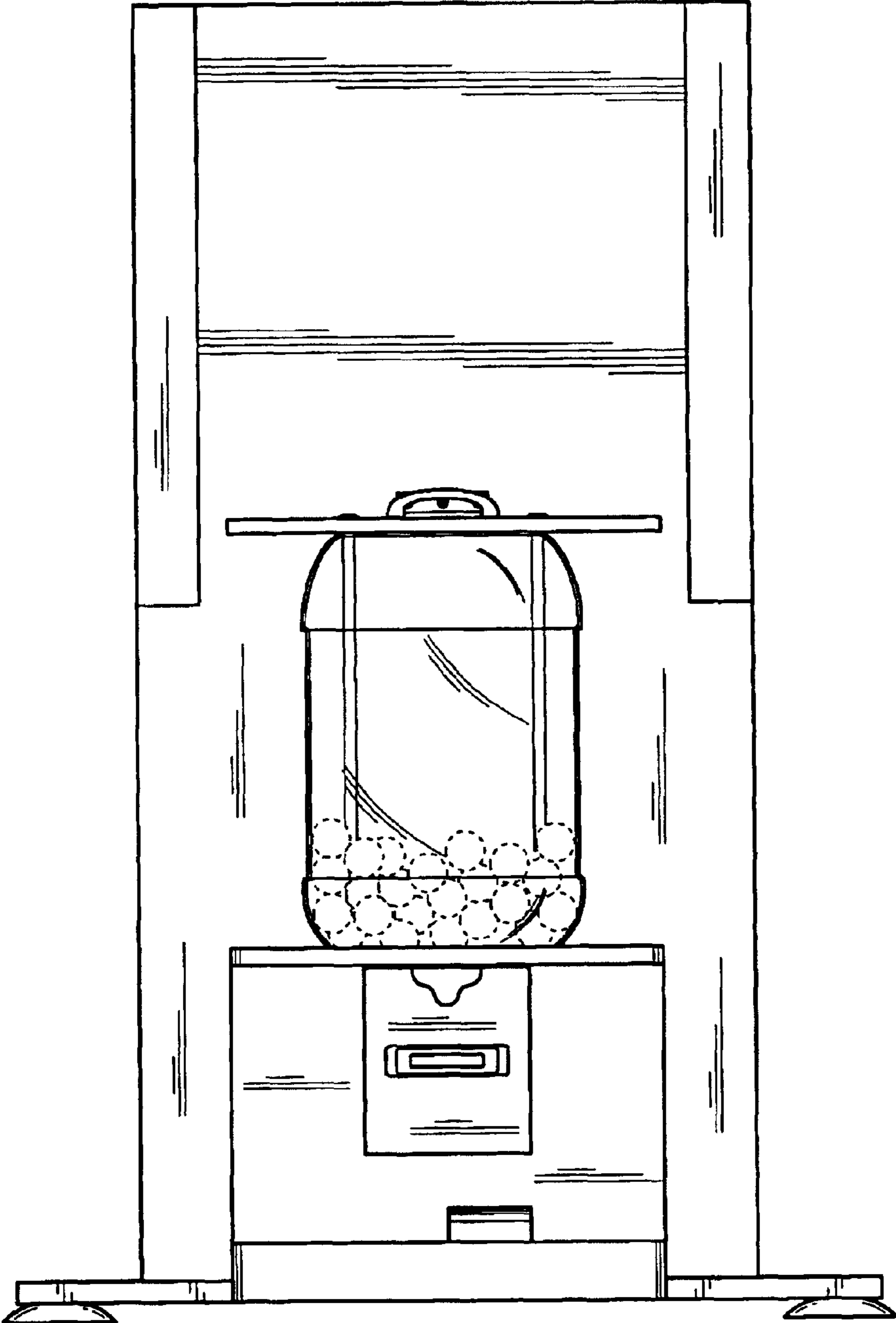

FIG. 2

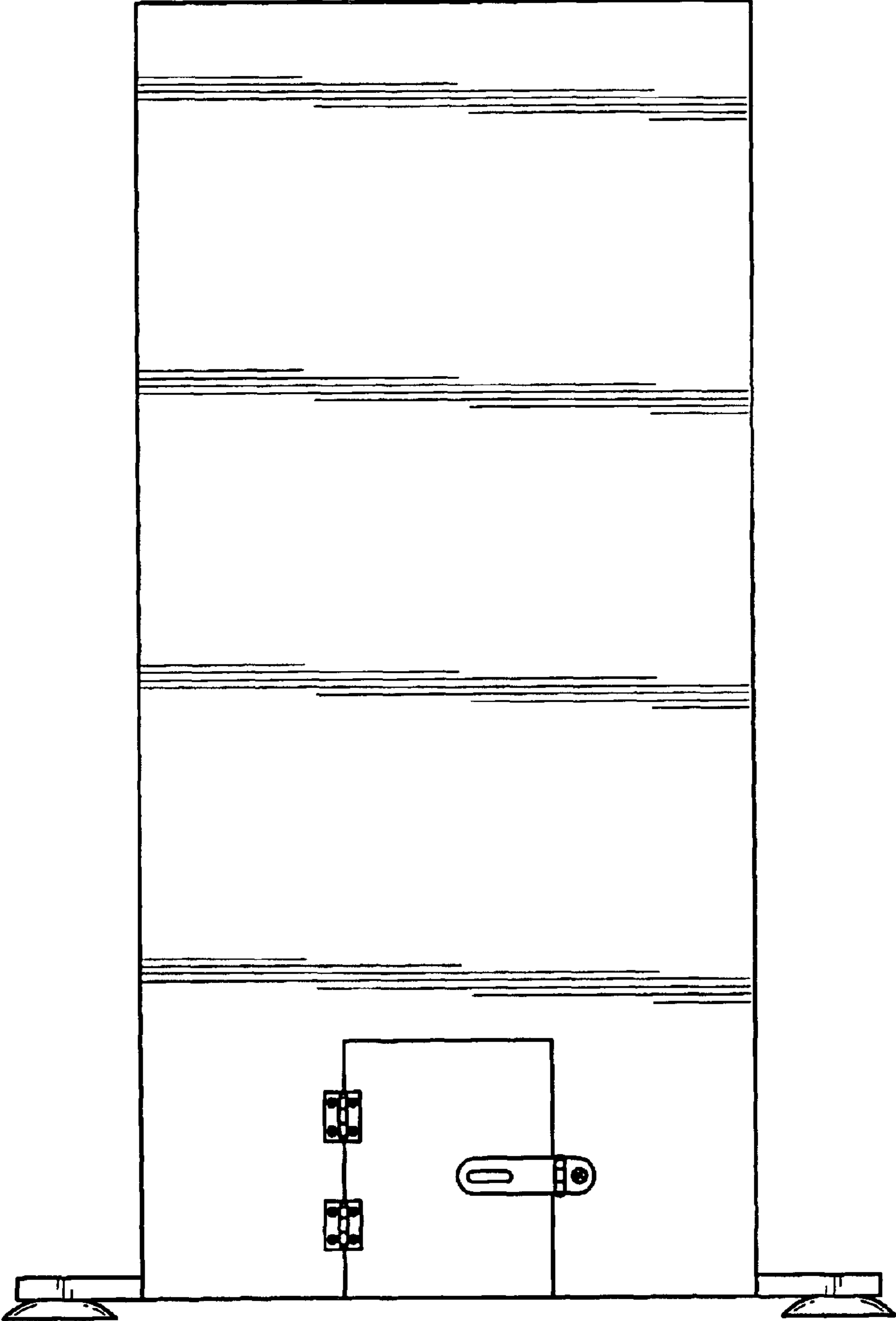

FIG. 3

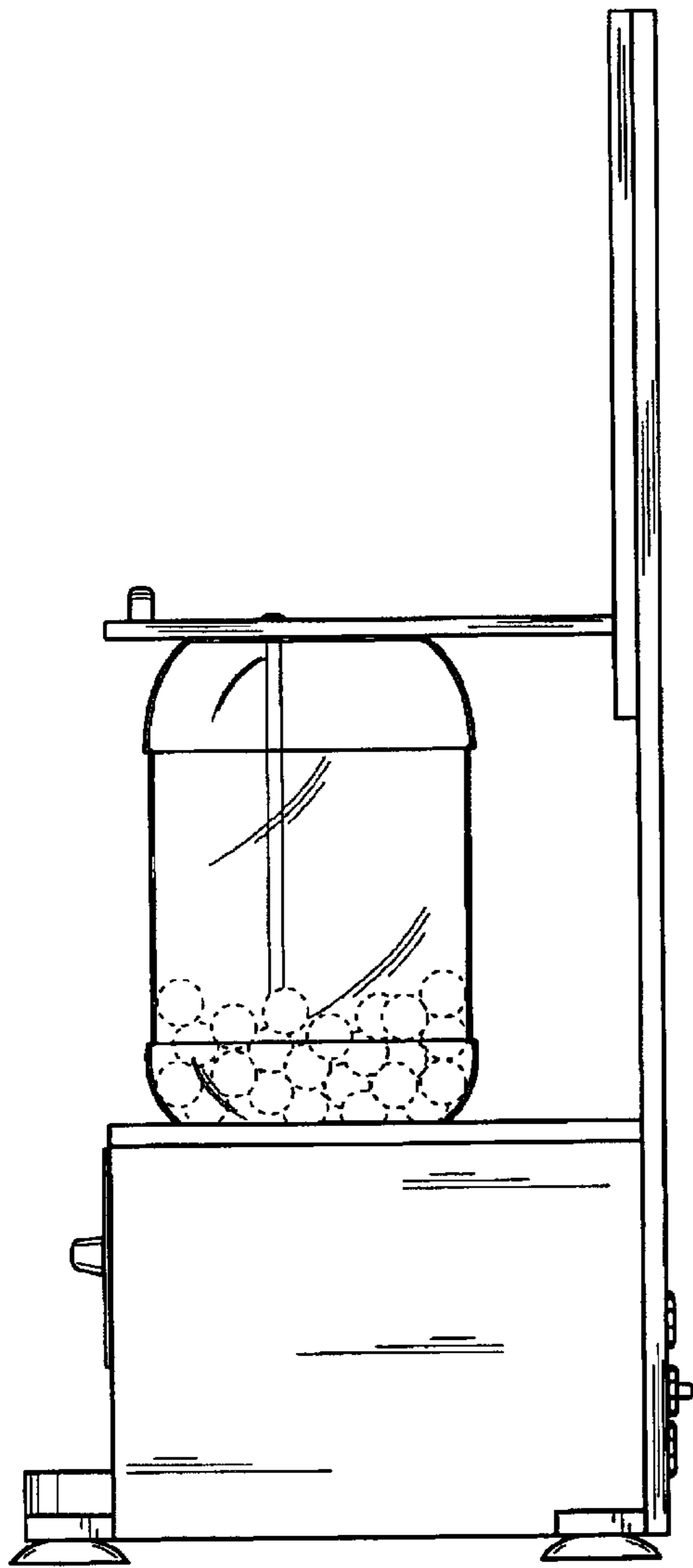

FIG. 4

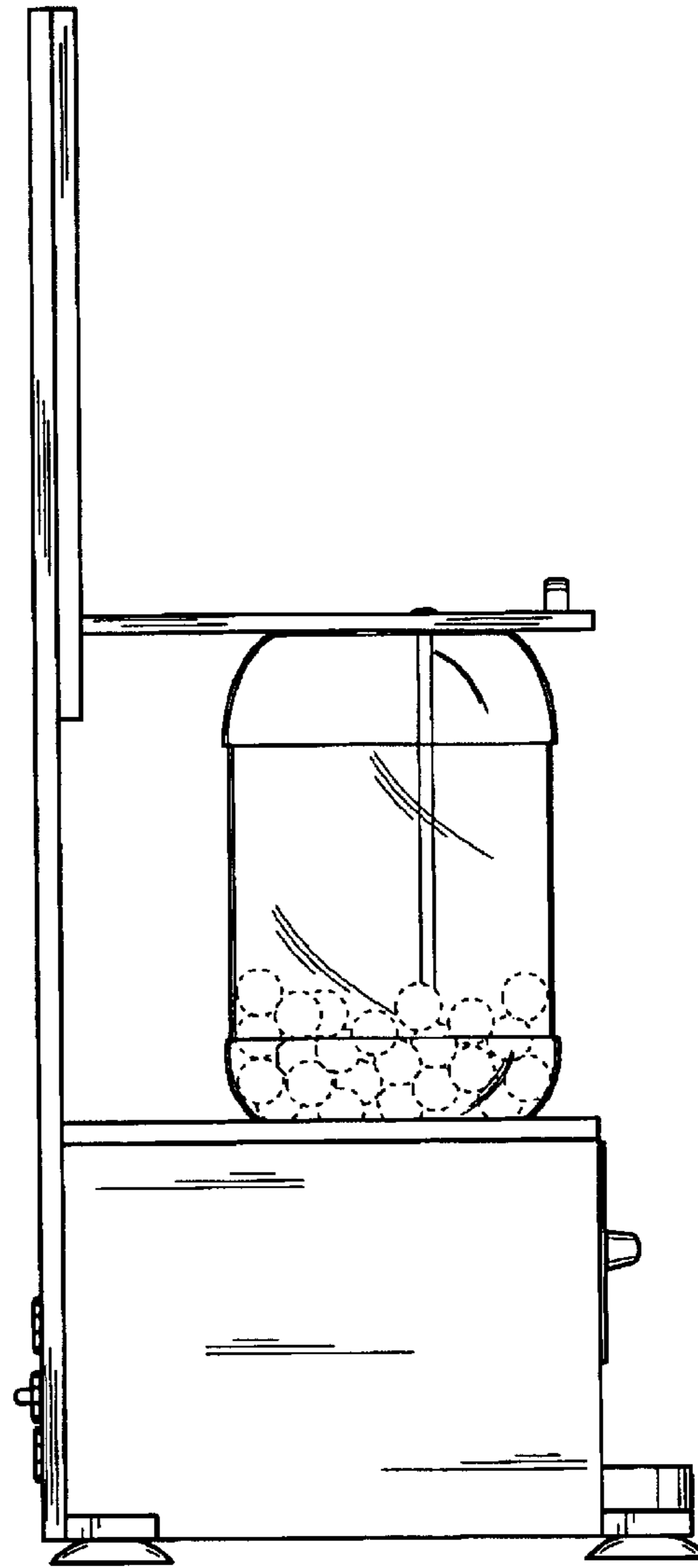

FIG. 5

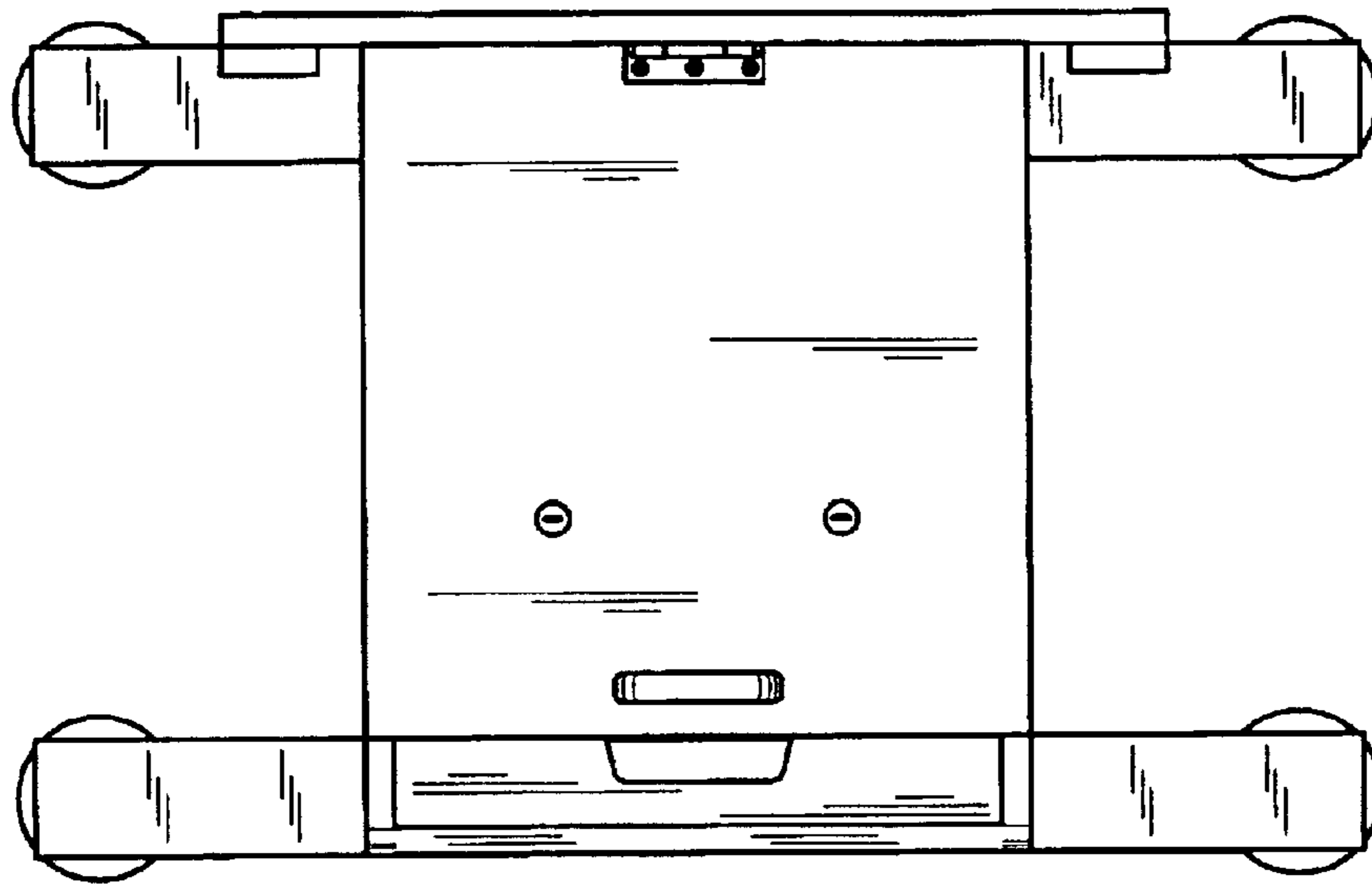

FIG. 6

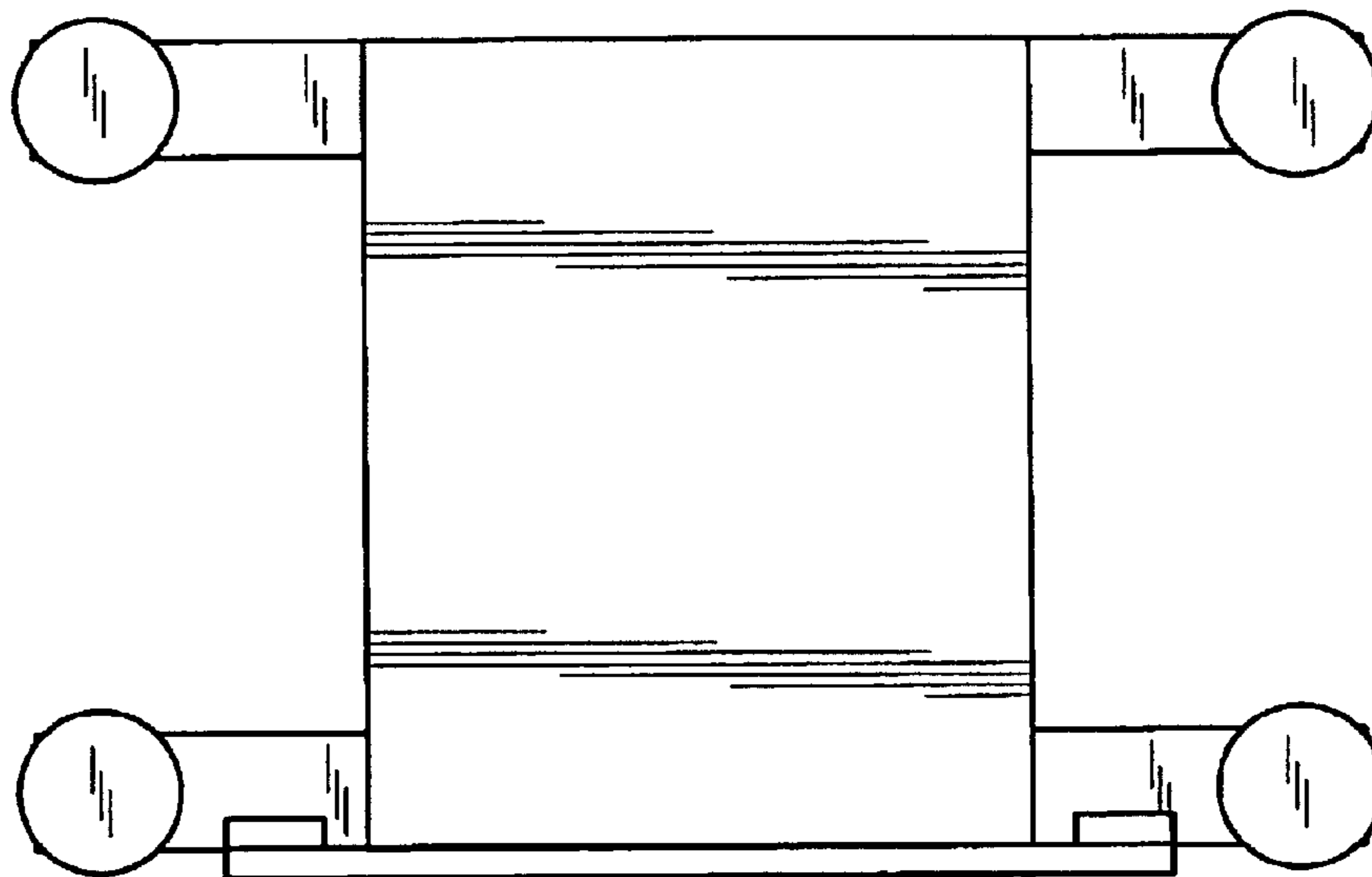

FIG. 7

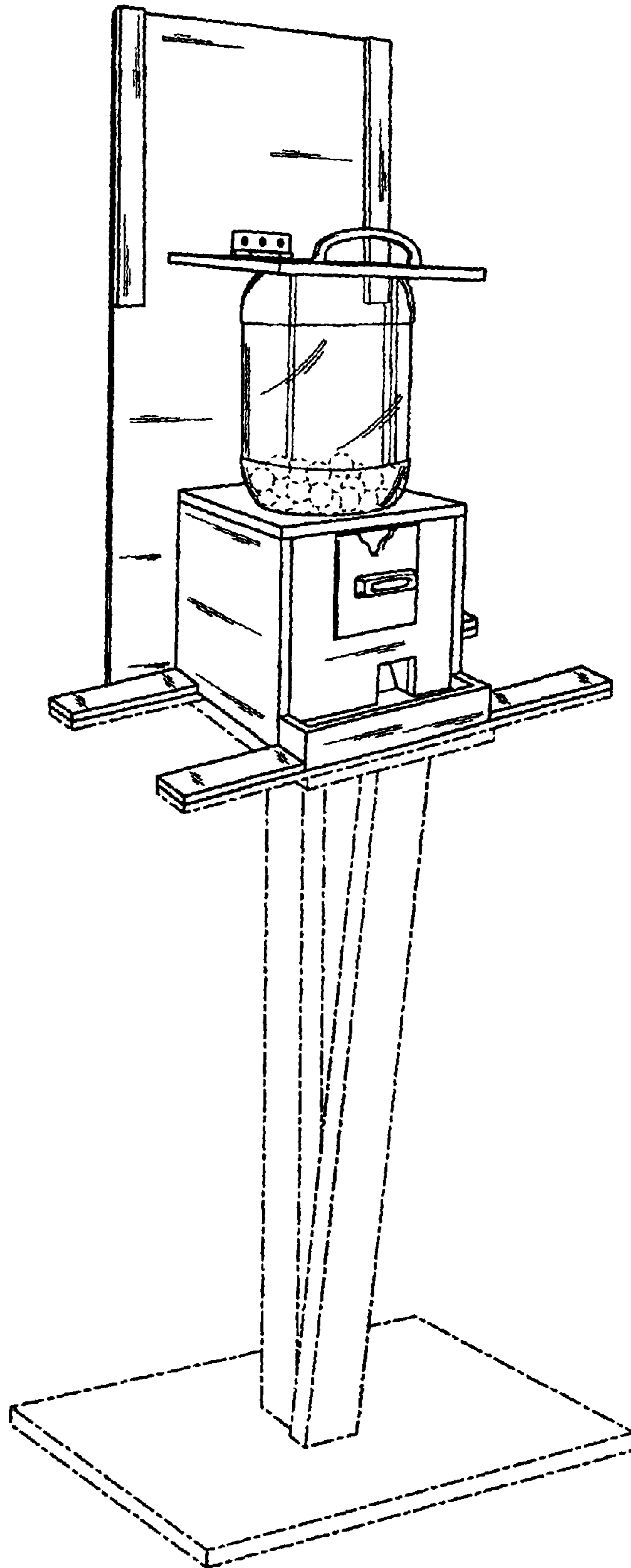

FIG. 8