



US00D497644S1

(12) **United States Design Patent**
Piacenza et al.

(10) **Patent No.:** **US D497,644 S**
(45) **Date of Patent:** **** Oct. 26, 2004**

(54) **CORRECTION MARKER**

(75) Inventors: **Donna Piacenza**, Woodside, CA (US);
Amar Patel, Arlington Heights, IL (US)

(73) Assignee: **Sanford, L.P.**, Freeport, IL (US)

(**) Term: **14 Years**

(21) Appl. No.: **29/201,369**

(22) Filed: **Mar. 15, 2004**

(51) **LOC (7) Cl.** **19-06**

(52) **U.S. Cl.** **D19/53; D19/46; D19/49**

(58) **Field of Search** **D19/35, 36, 41-51,**
D19/53-58, 66, 71, 81-85; 401/98, 202,
196, 198, 199, 213, 243-247, 260-262,
60, 99

(56) **References Cited**

U.S. PATENT DOCUMENTS

1,693,151	A	*	11/1928	Mayer	401/60
1,734,117	A	*	11/1929	Corvell	401/60
1,859,775	A	*	5/1932	Hyams	401/98
D197,368	S	*	1/1964	Sydrowski	D28/88
D260,272	S	*	8/1981	Horntrich	D19/43
4,518,273	A	*	5/1985	Larizza	401/98
4,653,949	A	*	3/1987	Larizza	401/99
D310,449	S	*	9/1990	Agrippino	D19/36
D469,806	S	*	2/2003	Chan	D19/46

* cited by examiner

Primary Examiner—Martie K. Holtje

(74) *Attorney, Agent, or Firm*—Marshall, Gerstein & Borun
LLP

(57) **CLAIM**

The ornamental design for a “correction marker,” as shown and described.

DESCRIPTION

FIG. 1 is a perspective view showing our new design;
 FIG. 2 is a front elevational view, the rear elevational view being a mirror image thereof;
 FIG. 3 is a right side elevational view, the left side elevational view being a mirror image thereof;
 FIG. 4 is a top plan view thereof;
 FIG. 5 is a bottom plan view thereof;
 FIG. 6 is a perspective view showing the correction marker of FIG. 1 in another position;
 FIG. 7 is a front elevational view of the correction marker of FIG. 6, the rear elevational view being a mirror image thereof;
 FIG. 8 is a right side elevational view of the correction marker of FIG. 6, the left side elevational view being a mirror image thereof;
 FIG. 9 is a bottom plan view of the correction marker of FIG. 6;
 FIG. 10 is a top plan view of the correction marker of FIG. 6;
 FIG. 11 is a perspective view of the correction marker of FIG. 1 in another position; and,
 FIG. 12 is a perspective view of the correction maker of FIG. 1 in another position.

The dashed lines are for illustrative purposes only and form no part of the claimed design.

1 Claim, 5 Drawing Sheets

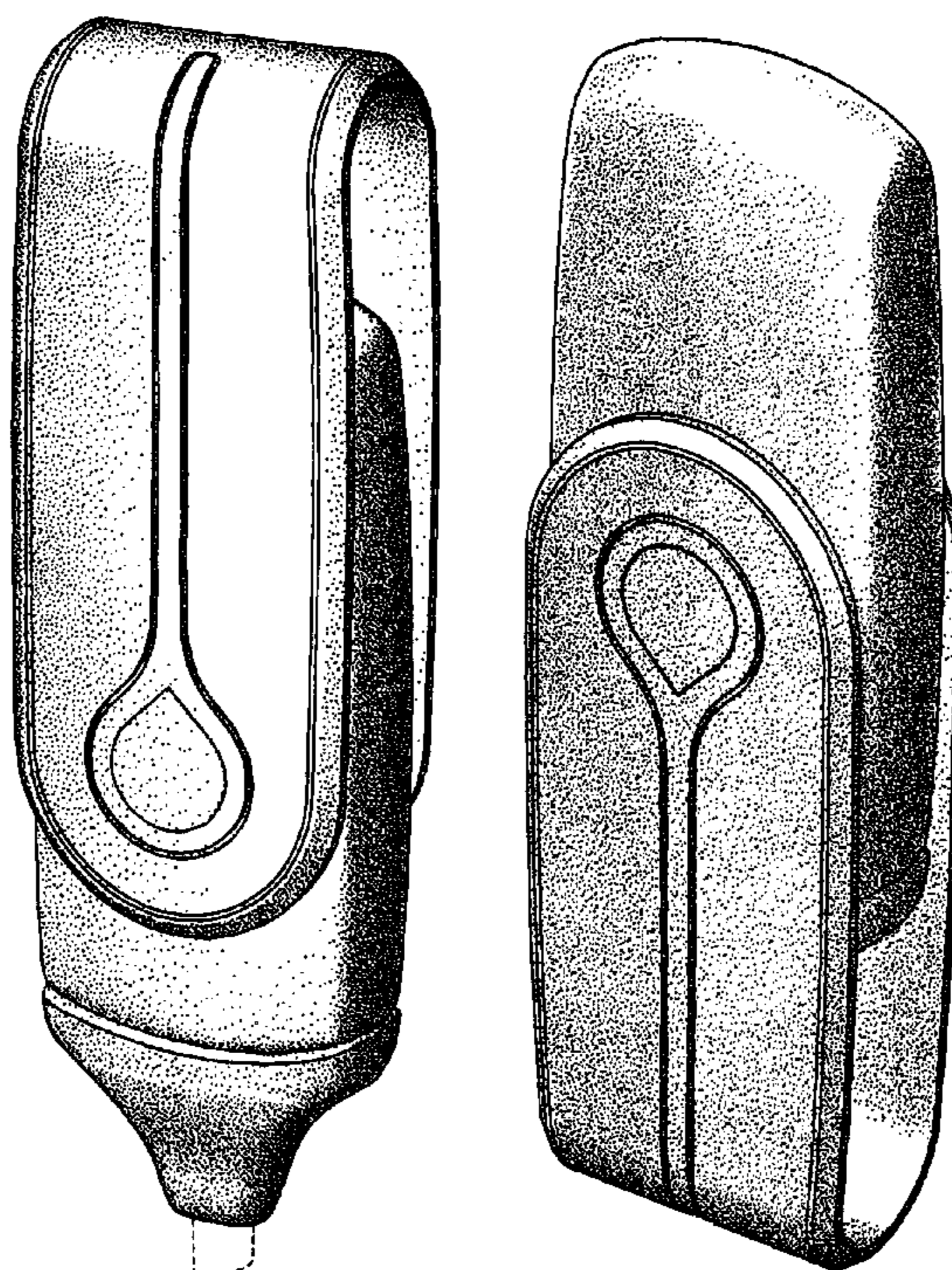

FIG. 1

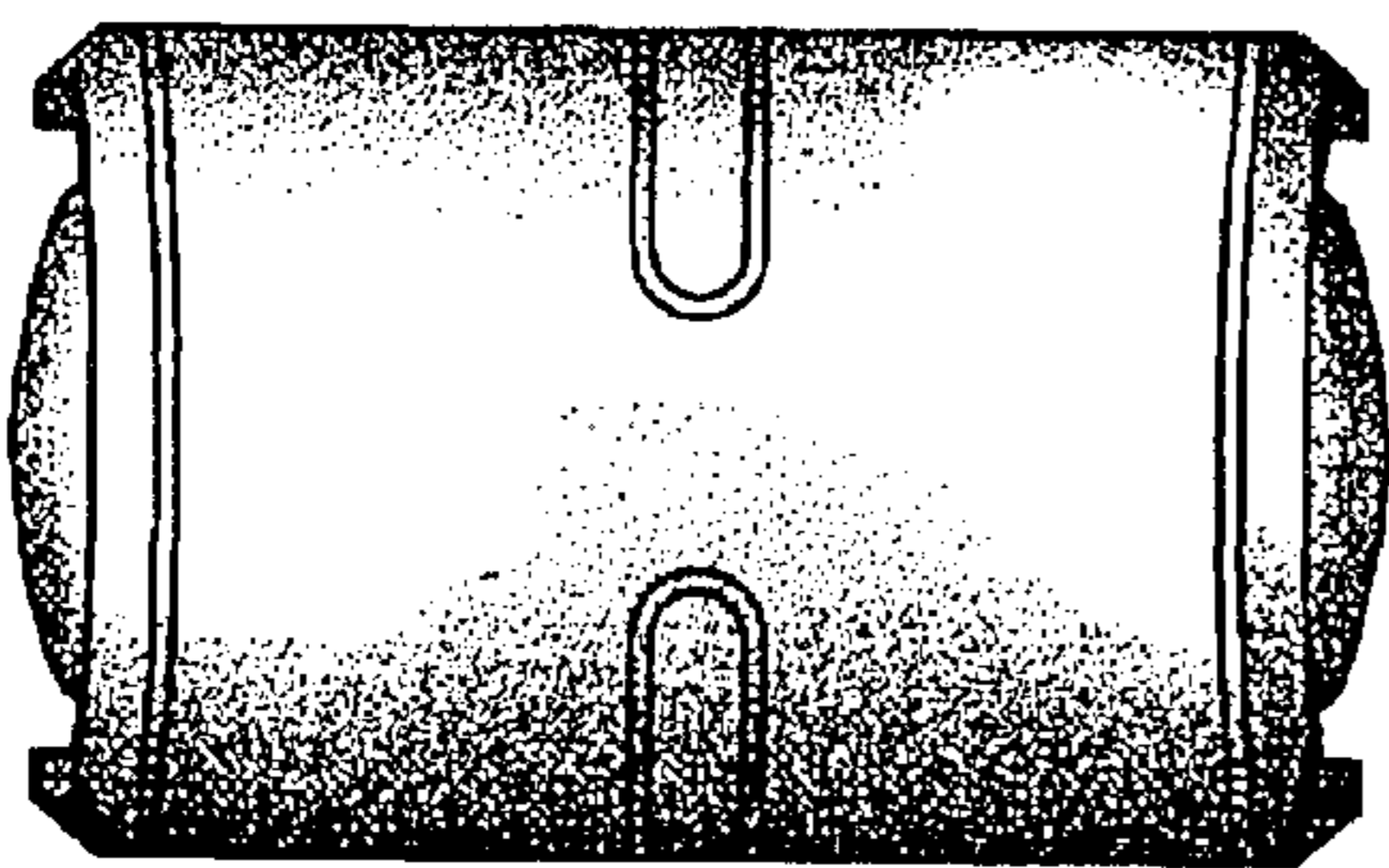
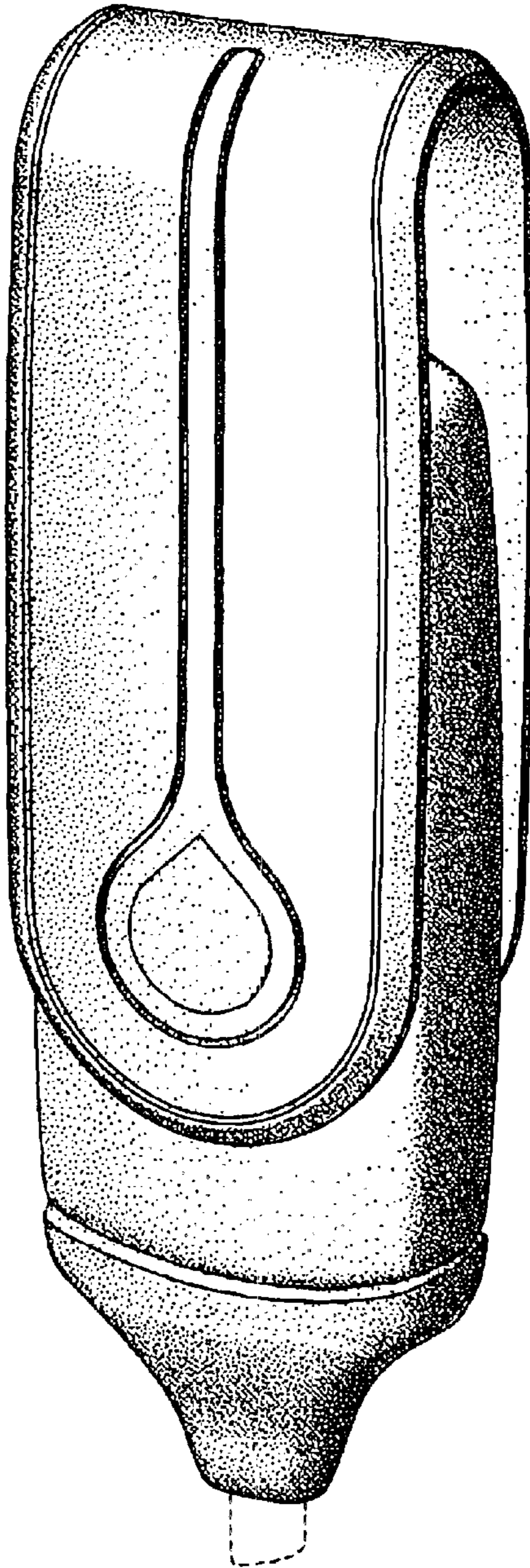

FIG. 4

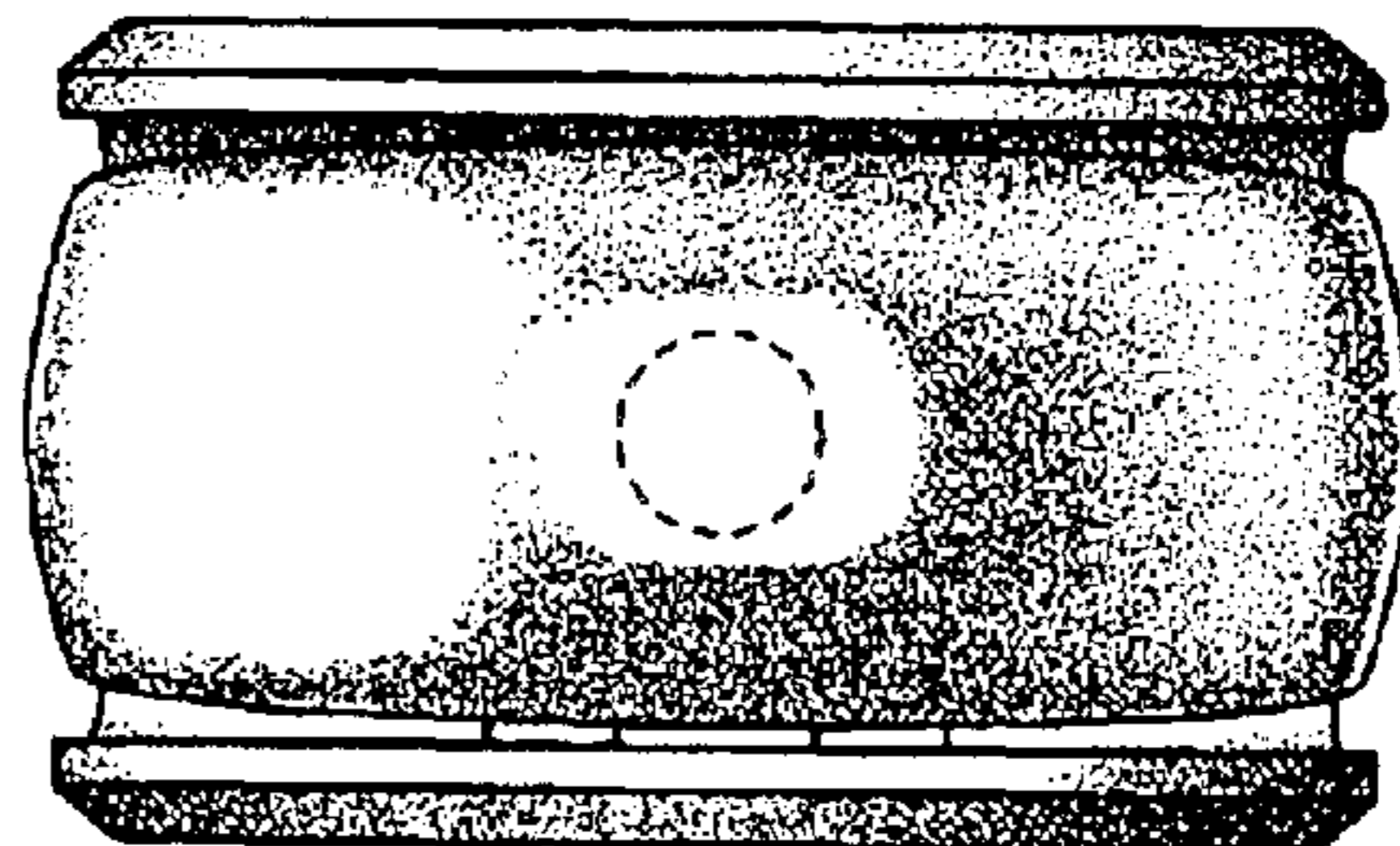

FIG. 5

FIG. 2

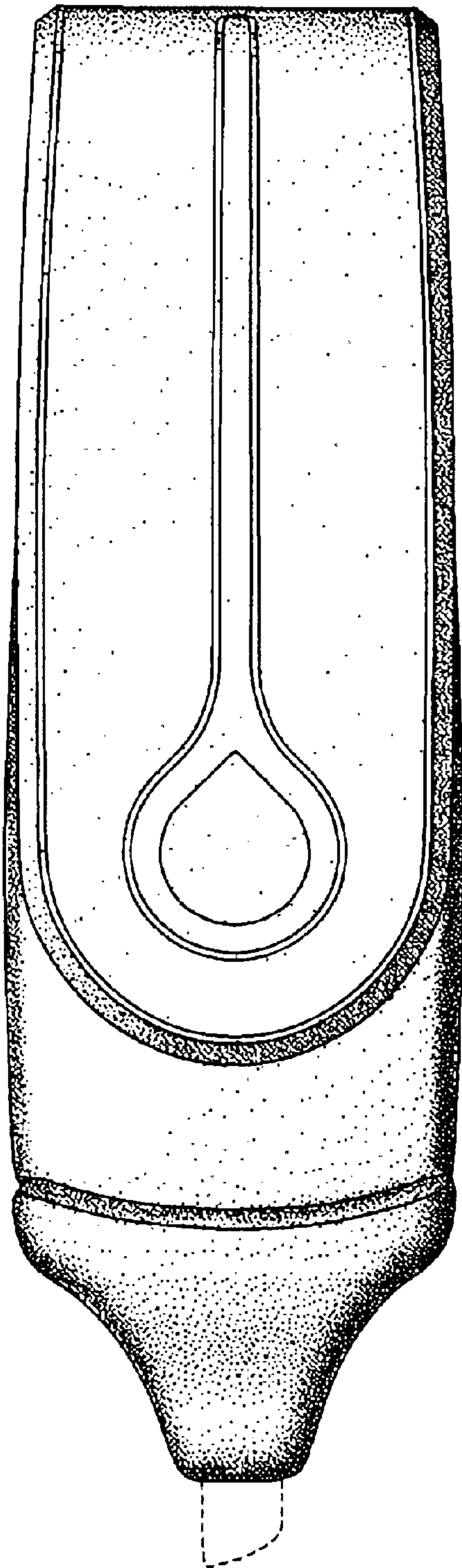

FIG. 3



FIG. 6

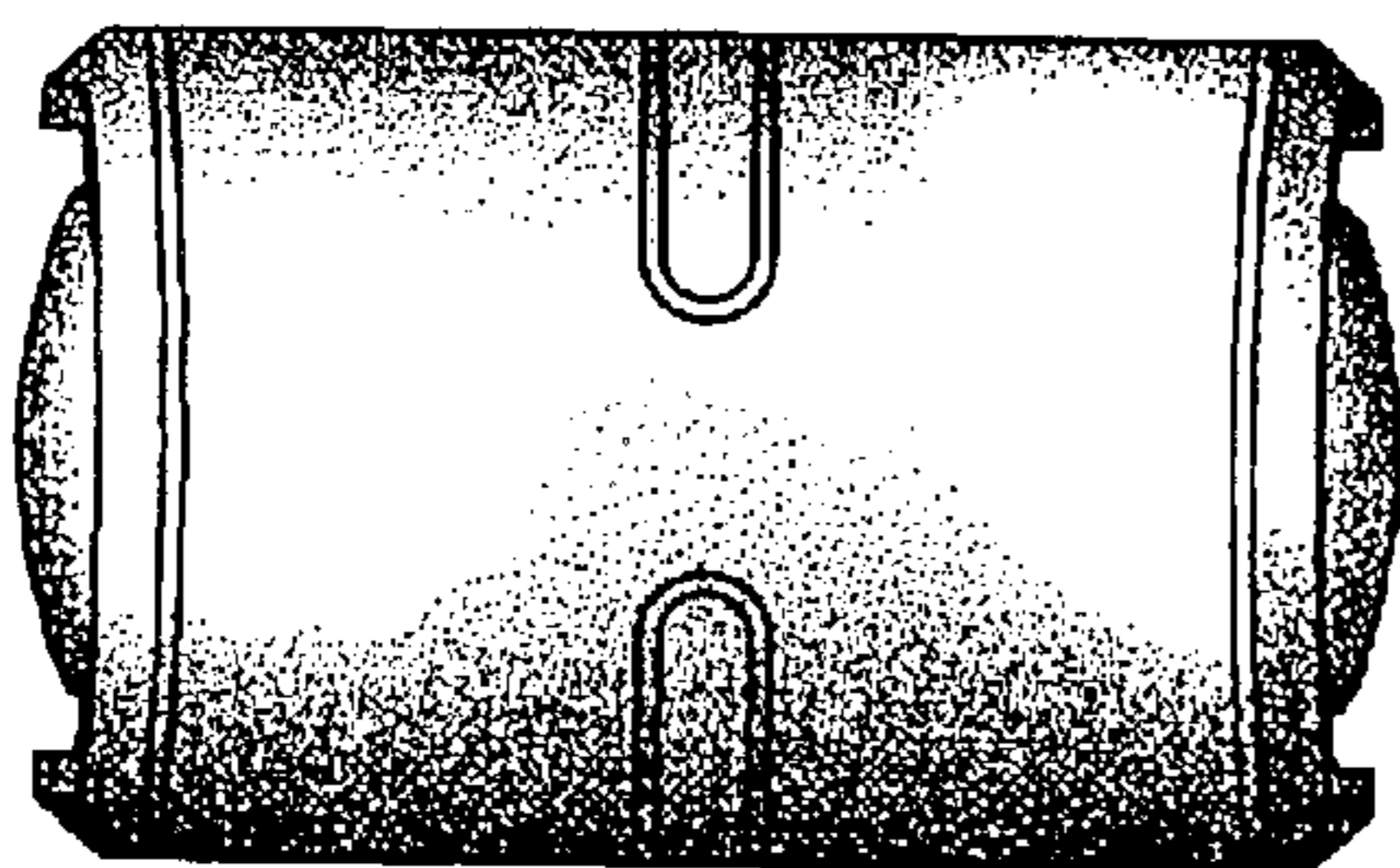
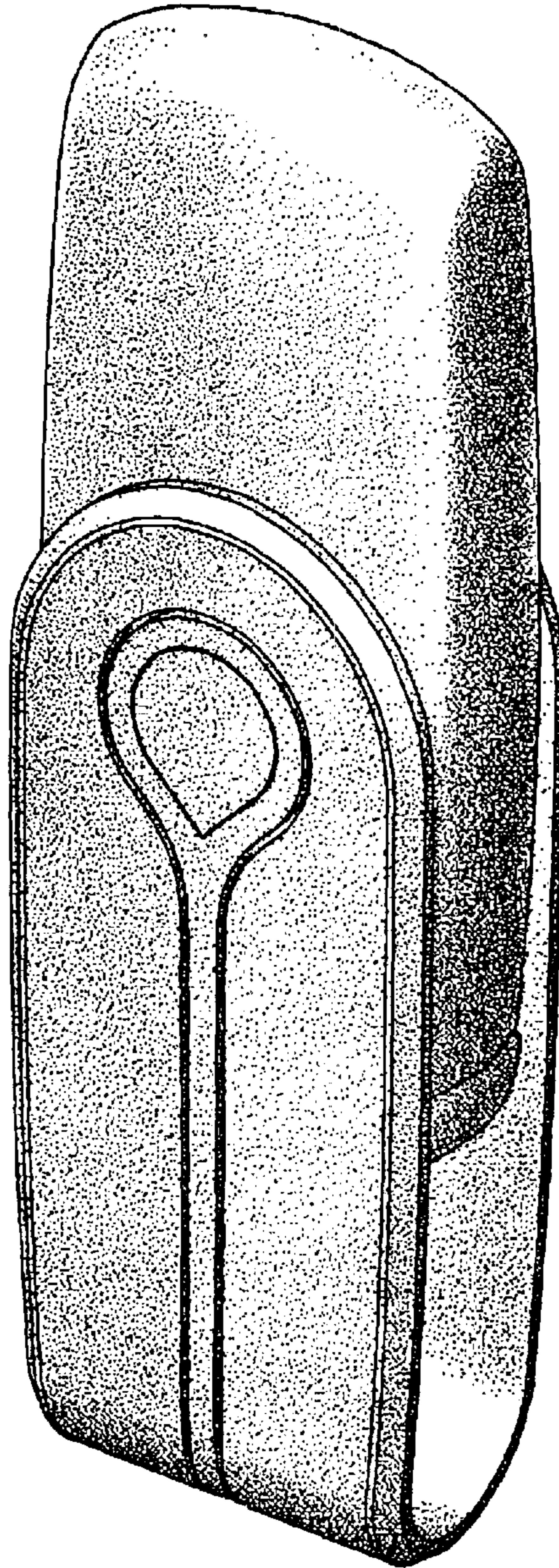

FIG. 9

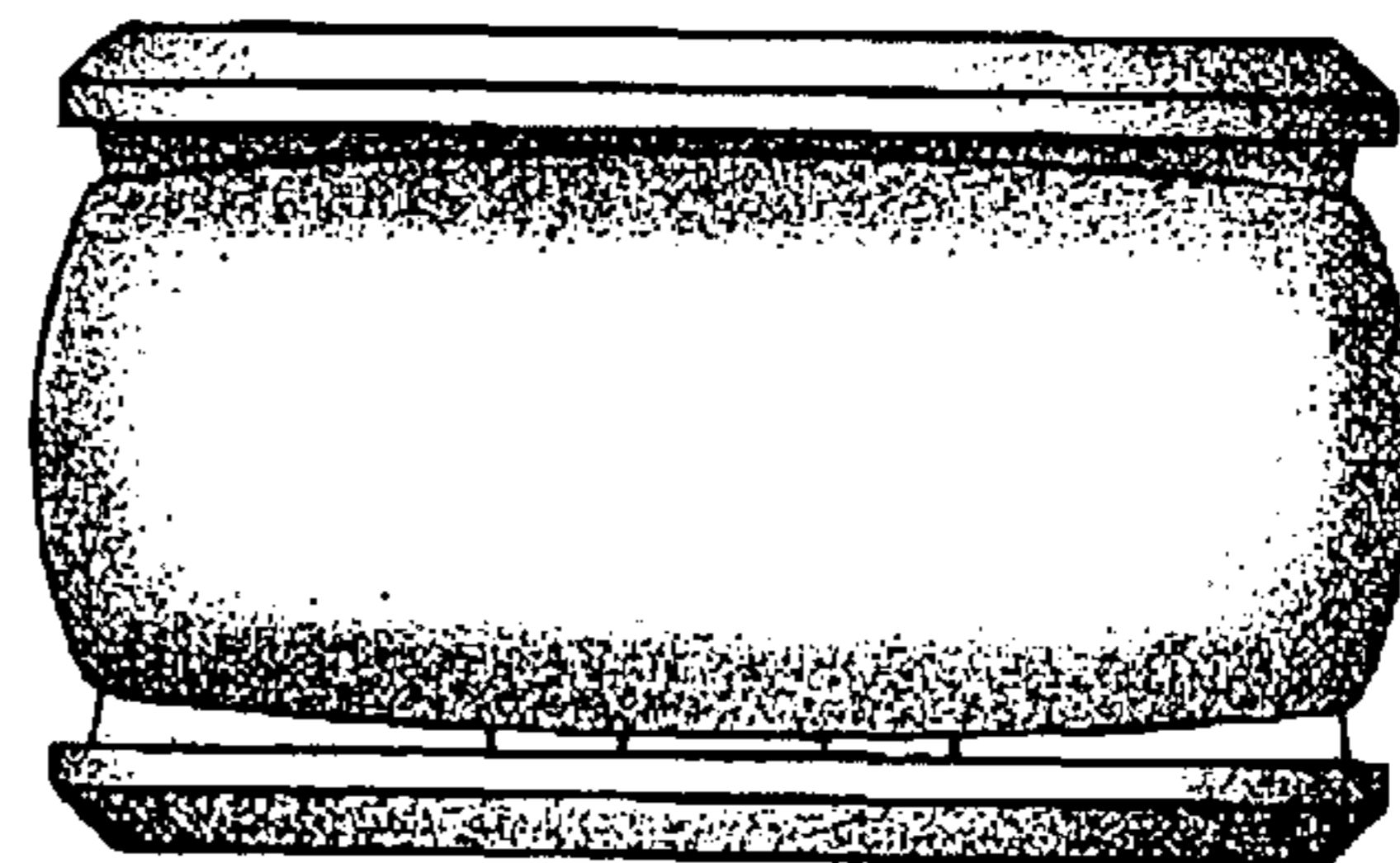

FIG. 10

FIG. 7

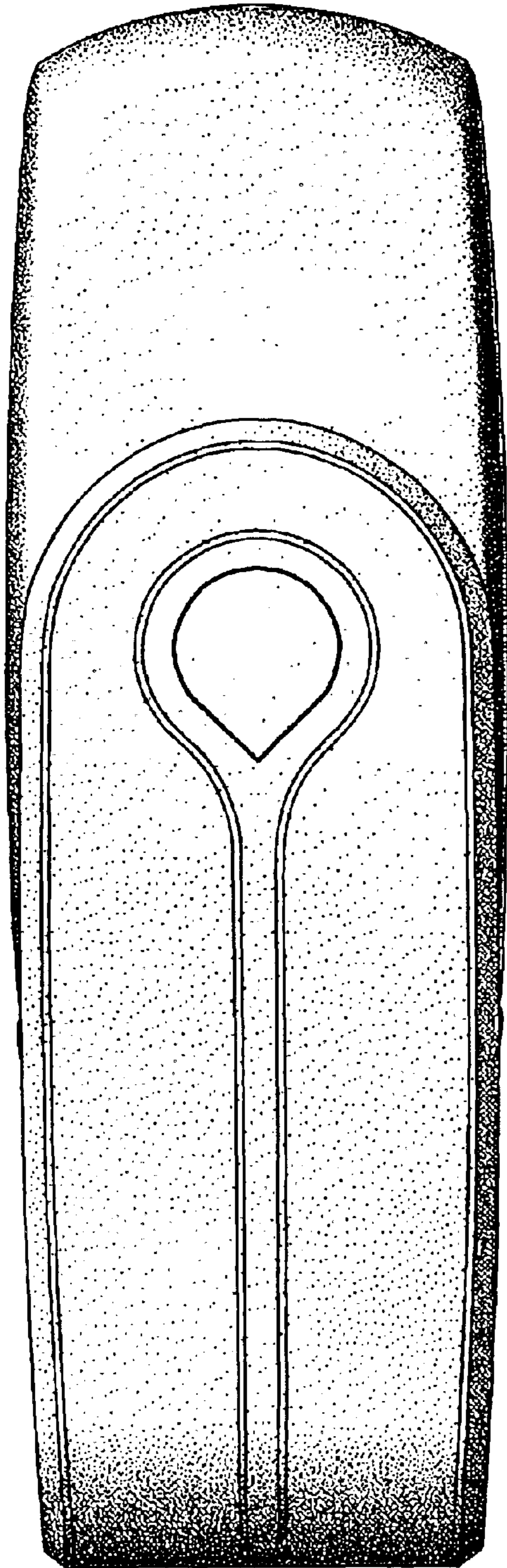

FIG. 8



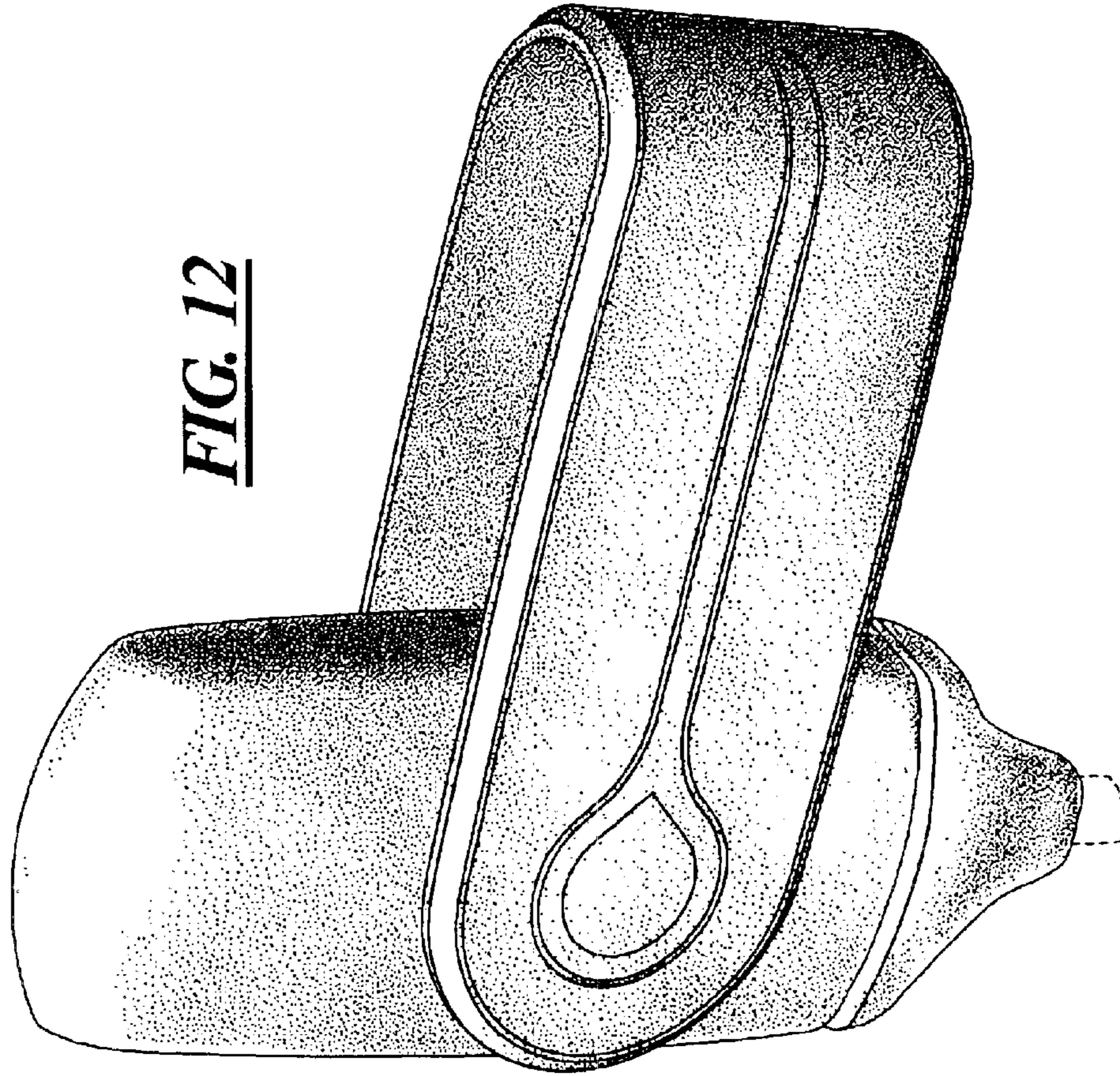

FIG. 12

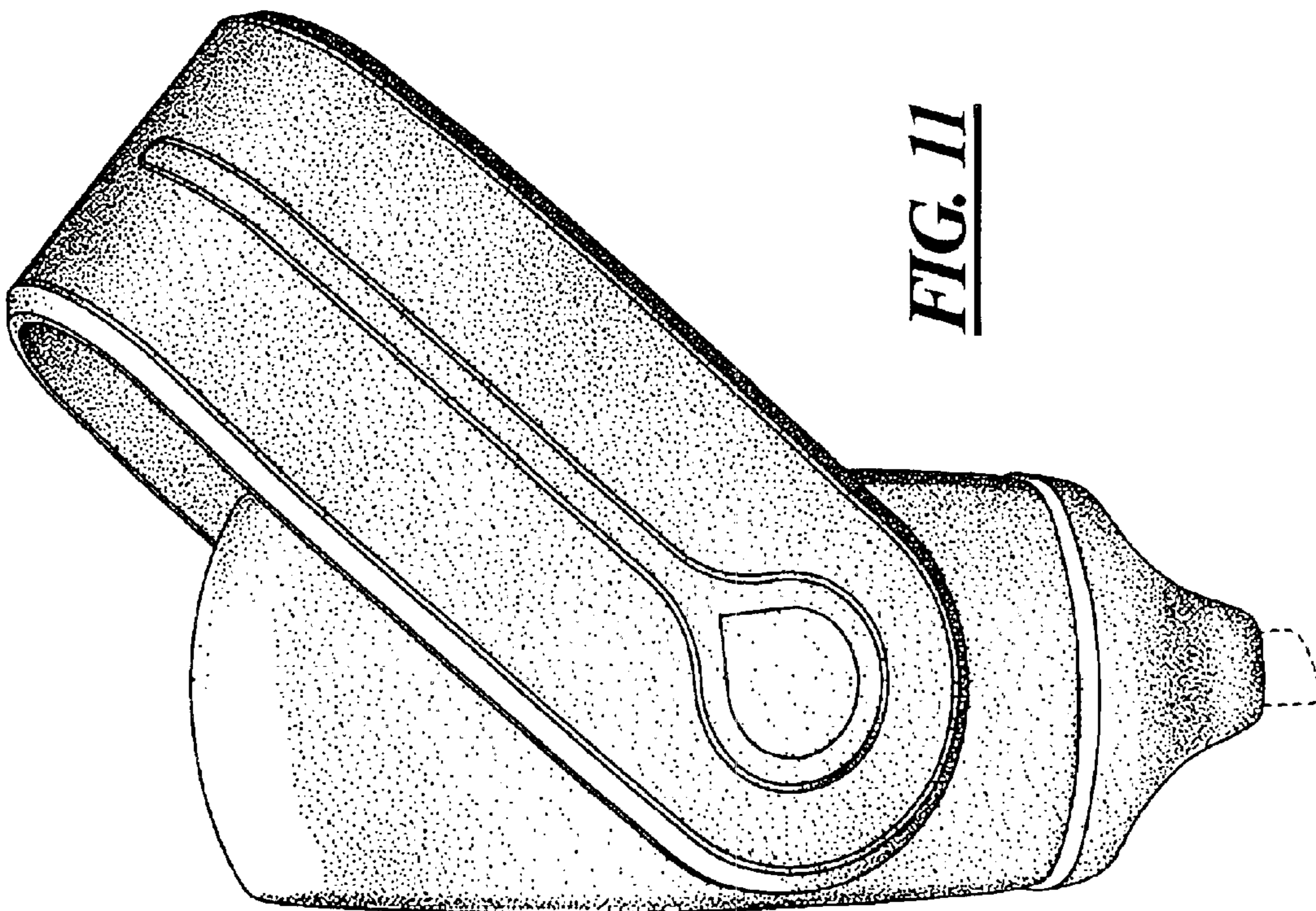

FIG. 11