

US00D497611S1

(12) **United States Design Patent**
Borsboom

(10) **Patent No.:** **US D497,611 S**
(45) **Date of Patent:** **** Oct. 26, 2004**

(54) **PAIR OF SPEAKERS**

(75) Inventor: **Antonious M. Borsboom**, Singapore (SG)

(73) Assignee: **Hannspree, Inc.**, Taipei (TW)

(**) Term: **14 Years**

(21) Appl. No.: **29/198,906**

(22) Filed: **Feb. 6, 2004**

(30) **Foreign Application Priority Data**

Jan. 20, 2004 (TW) 93300352

(51) **LOC (7) Cl.** **14-01**

(52) **U.S. Cl.** **D14/214**

(58) **Field of Search** D14/204, 207,
D14/209-216, 356; 181/143-144, 147-148,
150, 157, 198-199, 151, 153; 381/300-302,
306, 333, 345, 361-364, 386-388, 332,
336

(56) **References Cited**

U.S. PATENT DOCUMENTS

- D355,418 S * 2/1995 Parsey D14/214
- D391,574 S * 3/1998 Chen D14/211
- D392,289 S * 3/1998 Isonaga D14/214
- D392,975 S * 3/1998 Fenner et al. D14/214

* cited by examiner

Primary Examiner—Nanda Bondade
(74) *Attorney, Agent, or Firm*—Thomas, Kayden,
Horstemeyer & Risley

(57) **CLAIM**

The ornamental design for a pair of speakers, as shown and described.

DESCRIPTION

FIG. 1 is a front perspective view of the first speaker of the pair of speakers according to the present invention;
 FIG. 2 is a front elevational view thereof;
 FIG. 3 is a rear elevational view thereof;
 FIG. 4 is a left side elevational view thereof;
 FIG. 5 is a right side elevational view thereof;
 FIG. 6 is a top plan view thereof;
 FIG. 7 is a bottom plan view thereof;
 FIG. 8 is a rear perspective view thereof;
 FIG. 9 is a front perspective view of the second speaker of the pair of speakers of FIG. 1;
 FIG. 10 is a front elevational view thereof;
 FIG. 11 is a rear elevational view thereof;
 FIG. 12 is a left side view thereof;
 FIG. 13 is a right side thereof;
 FIG. 14 is a top plan view thereof;
 FIG. 15 is a bottom plan view thereof; and,
 FIG. 16 is a rear perspective view thereof.

1 Claim, 16 Drawing Sheets

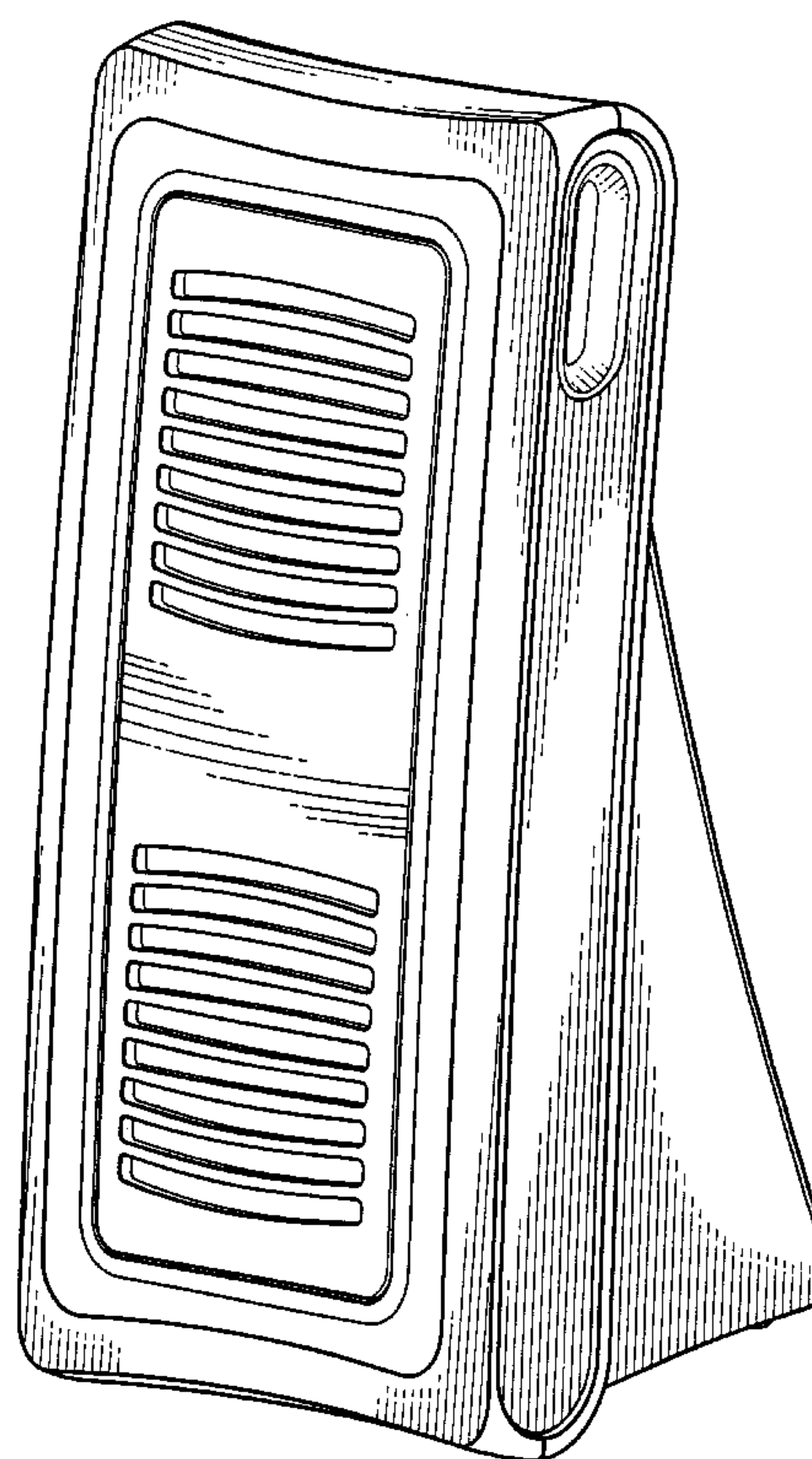
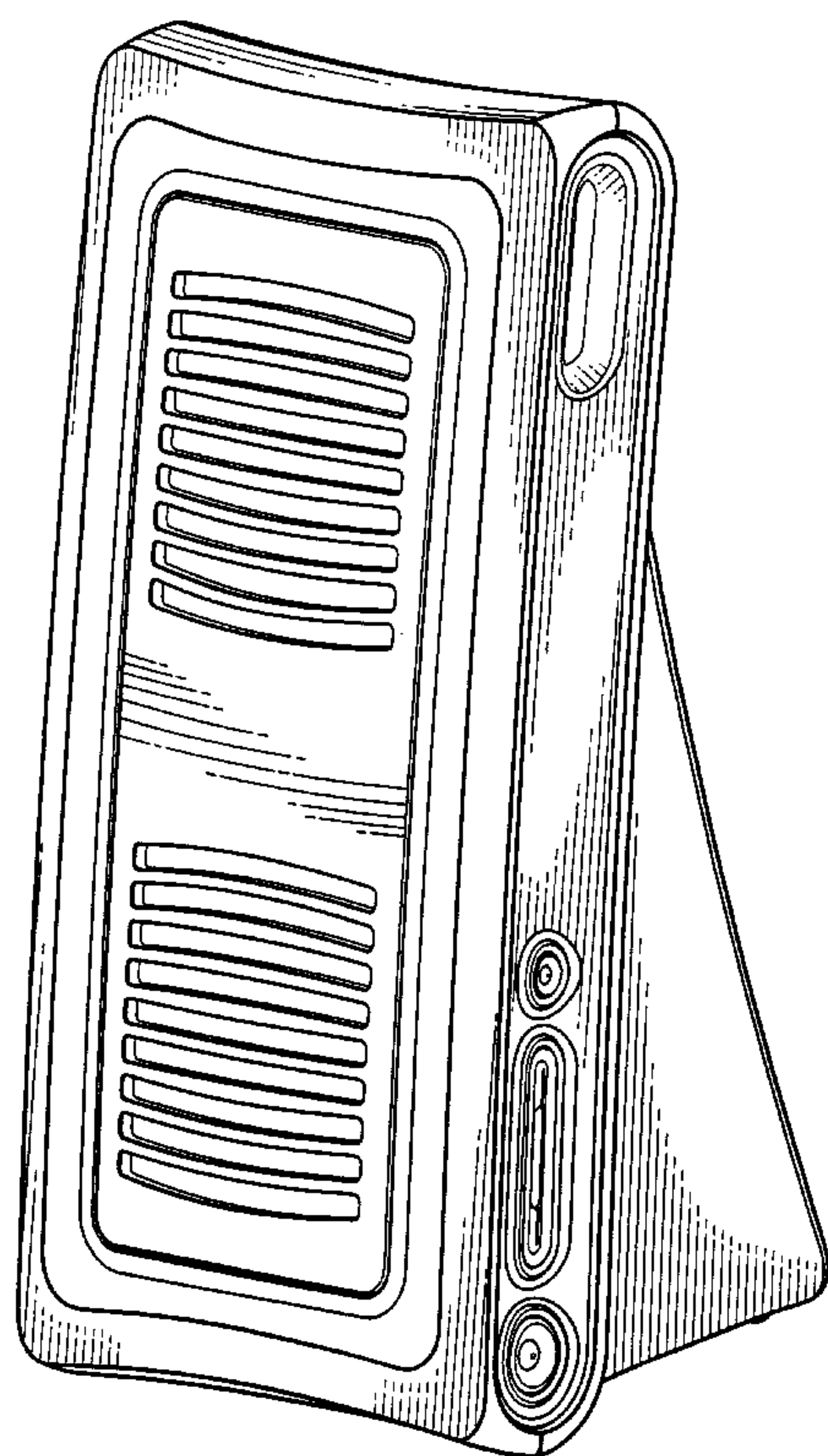

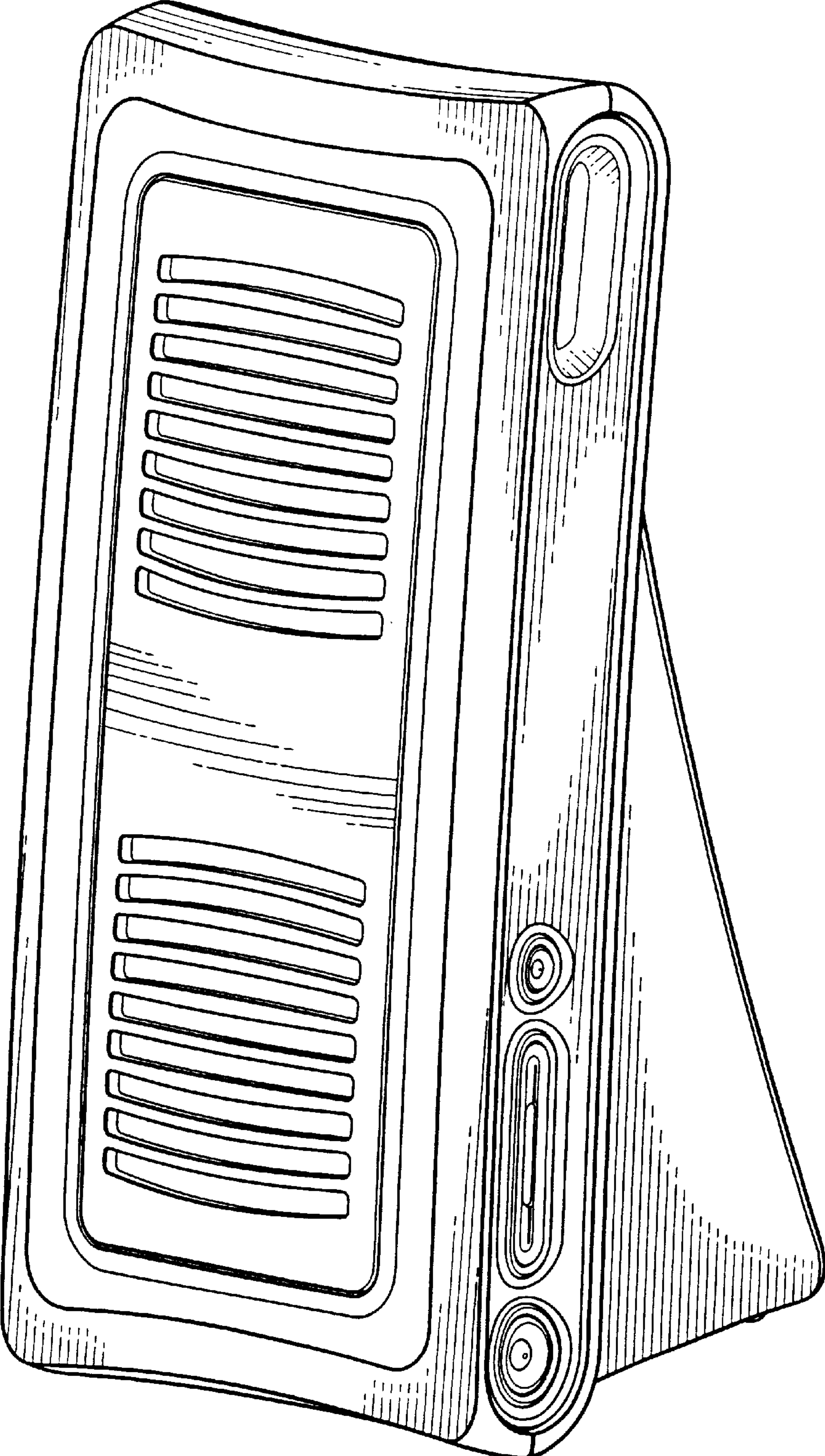

FIG. 1

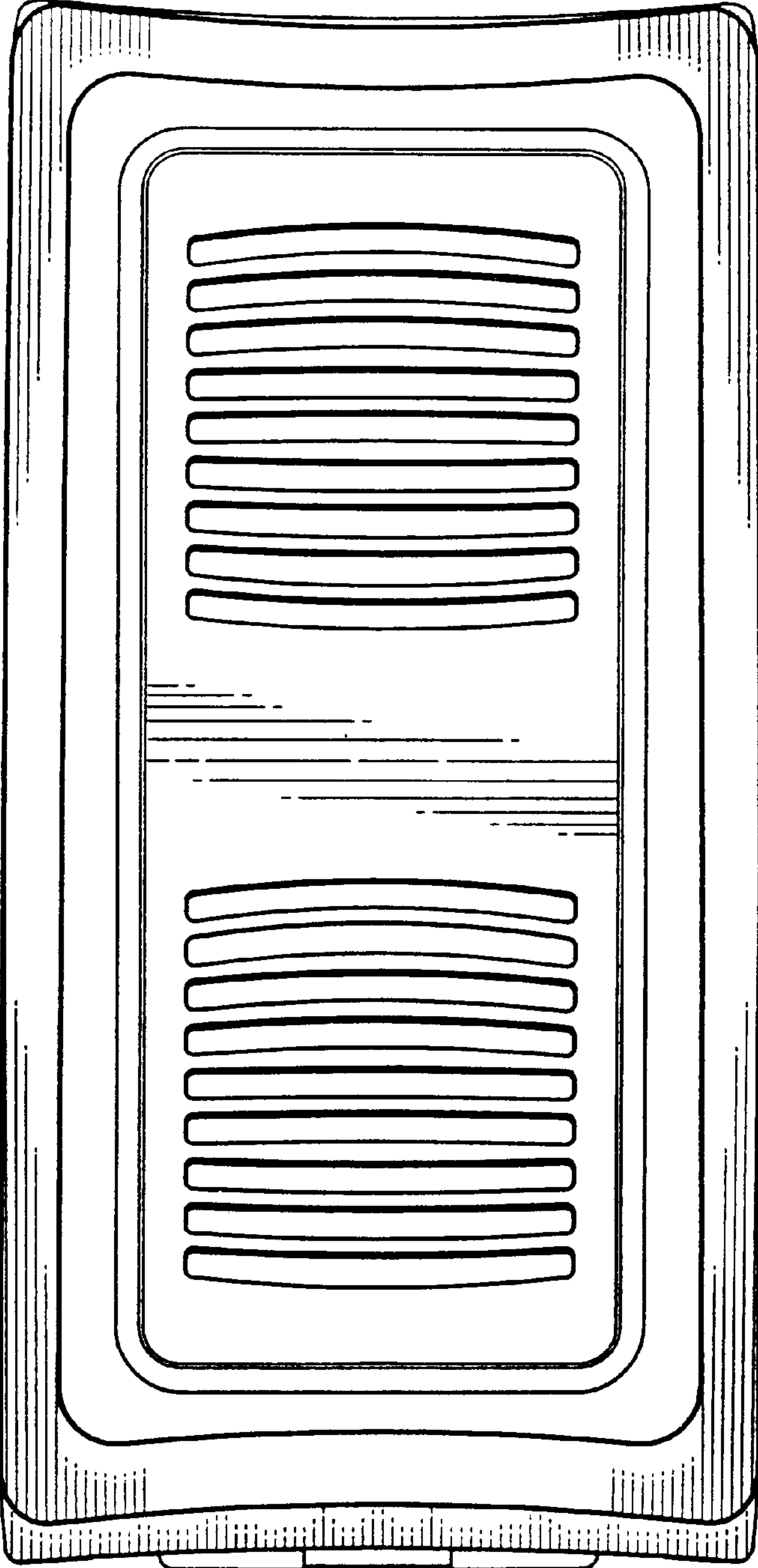

FIG. 2

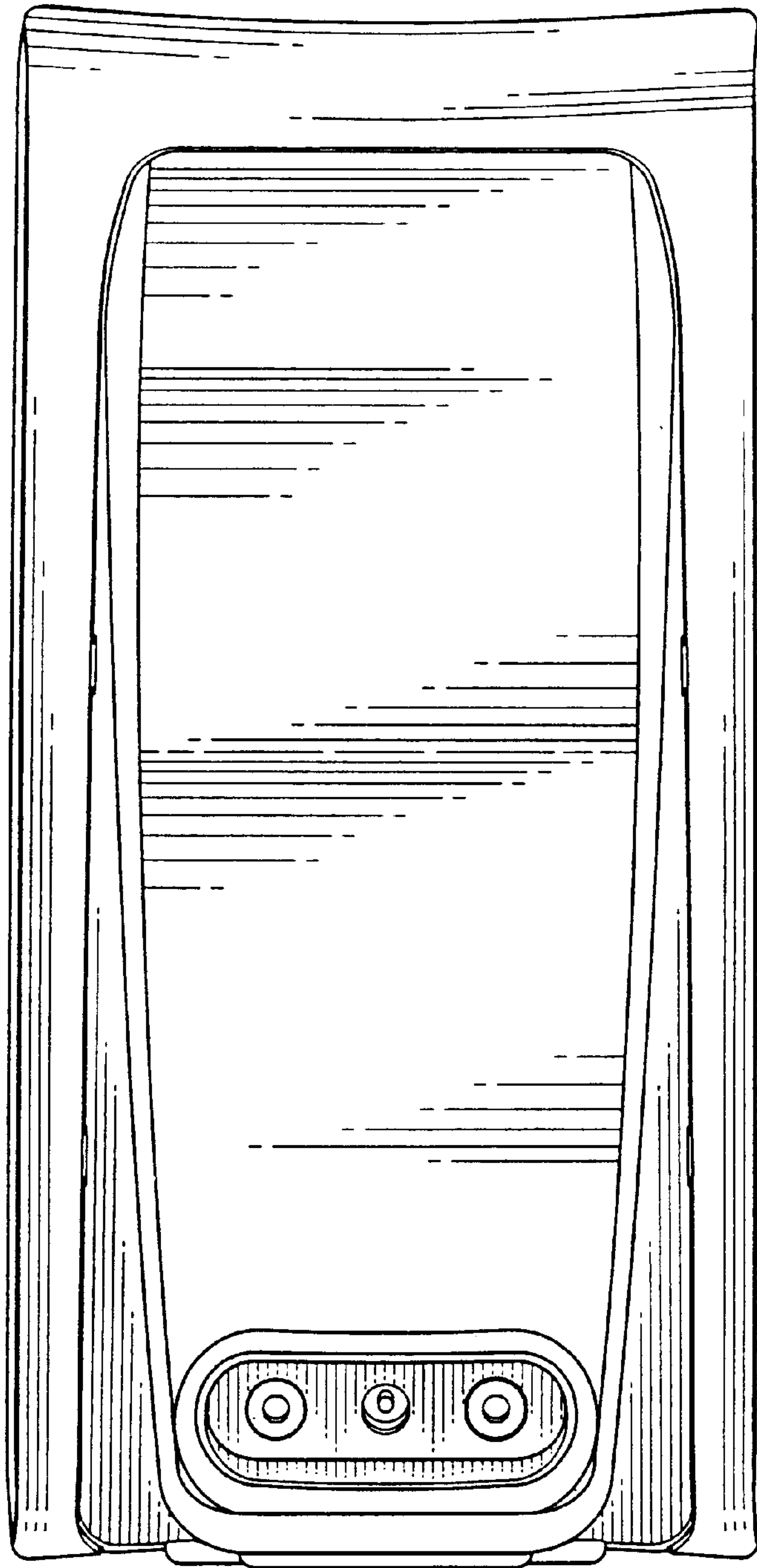

FIG. 3

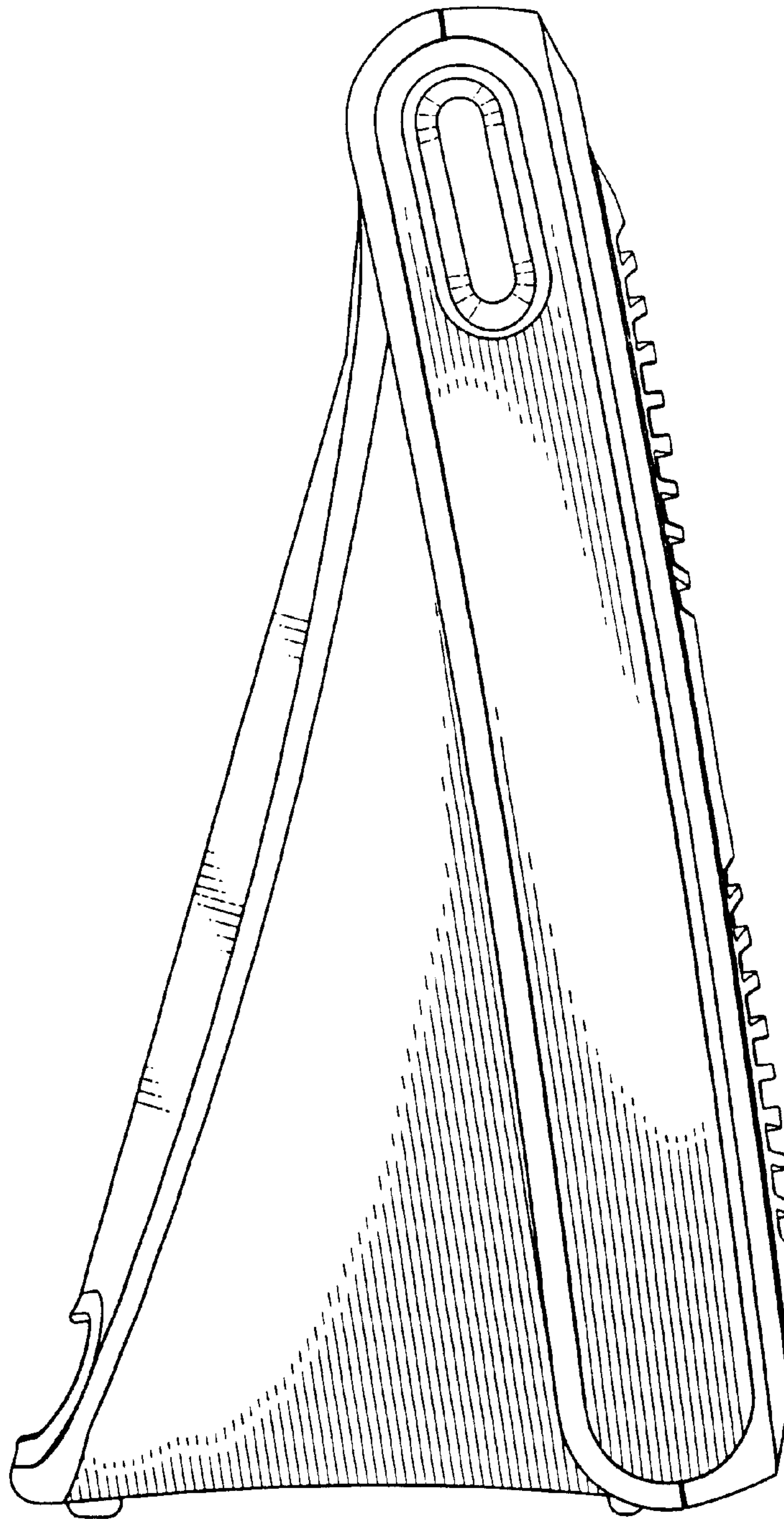

FIG. 4

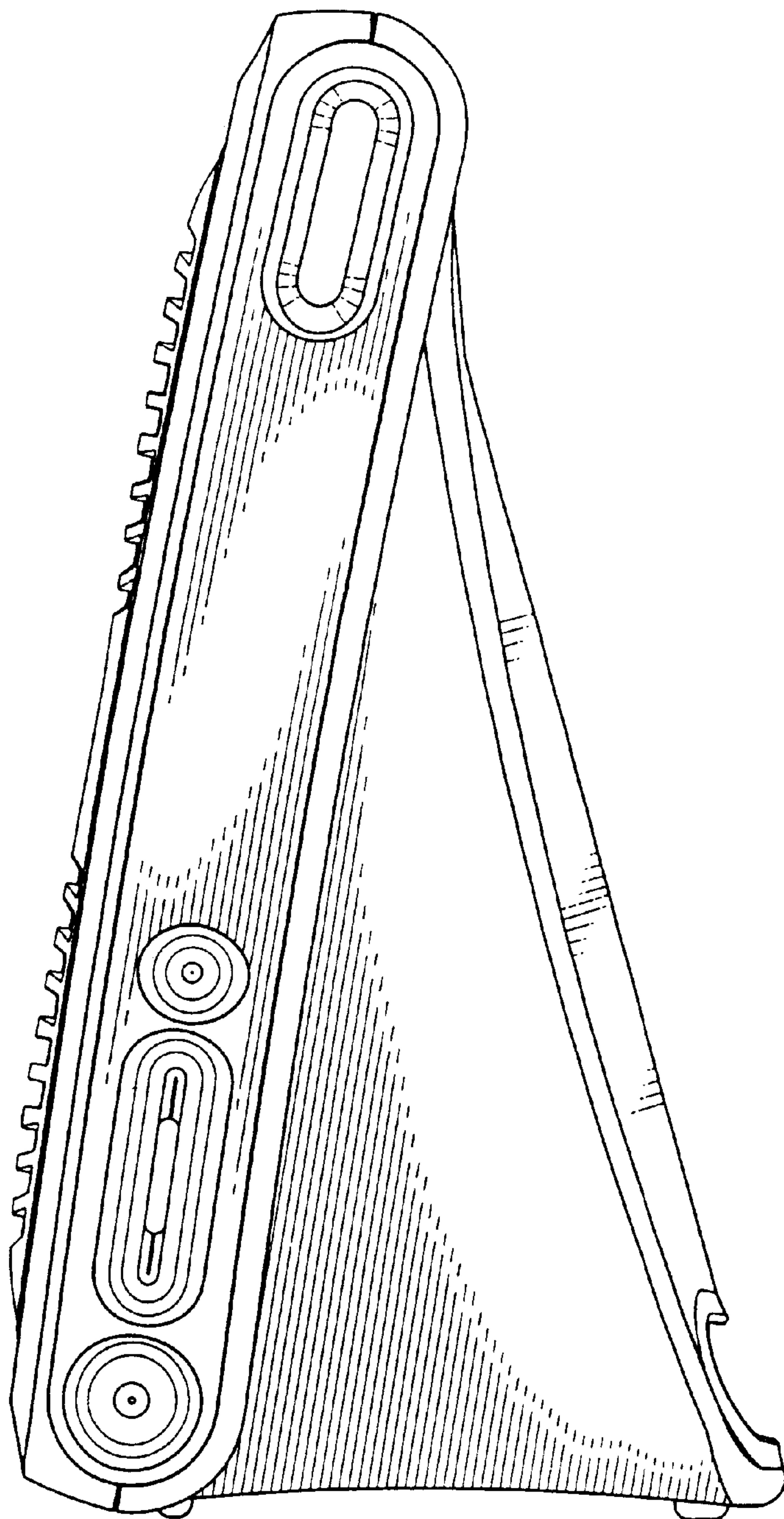

FIG. 5

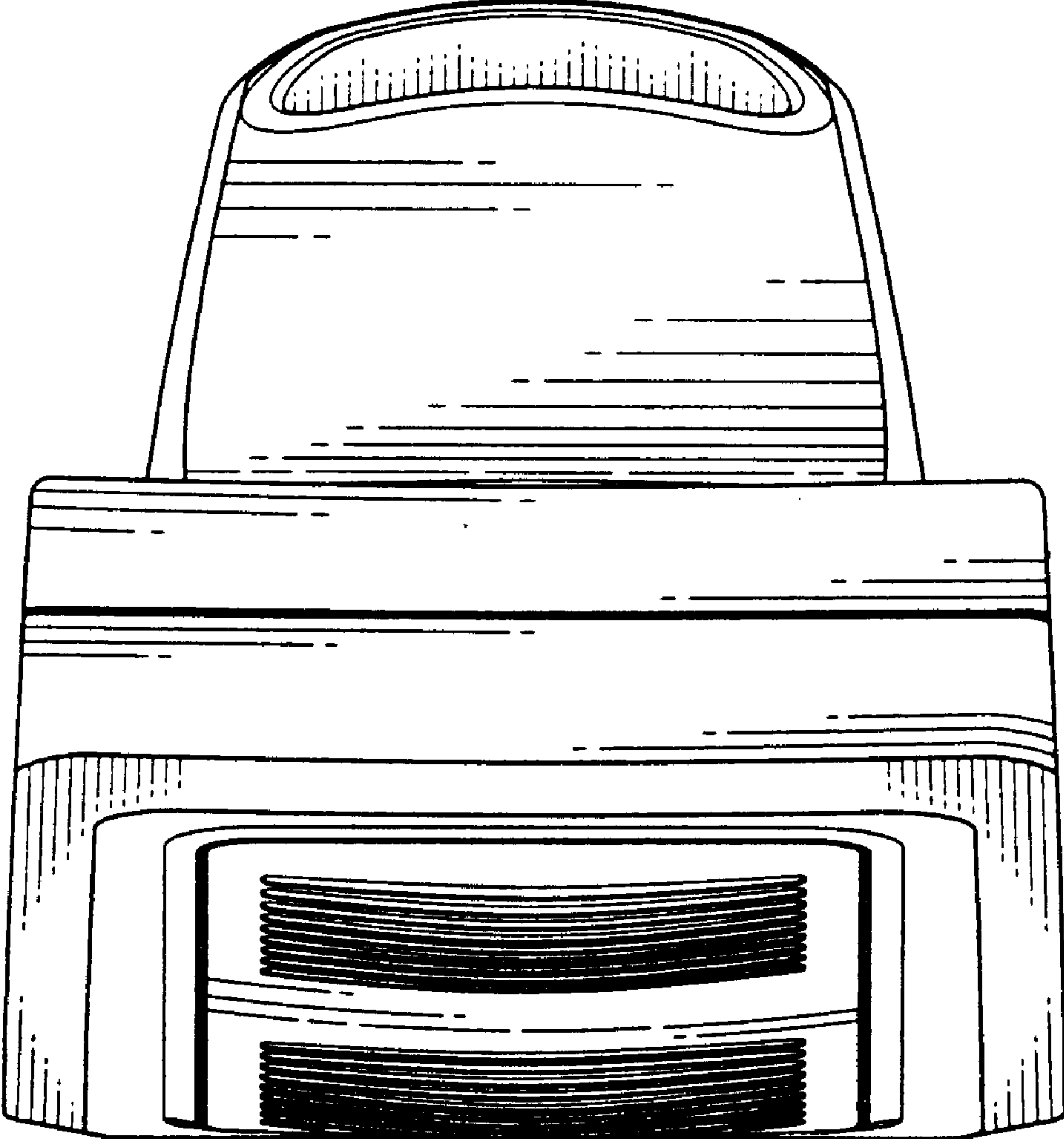

FIG. 6

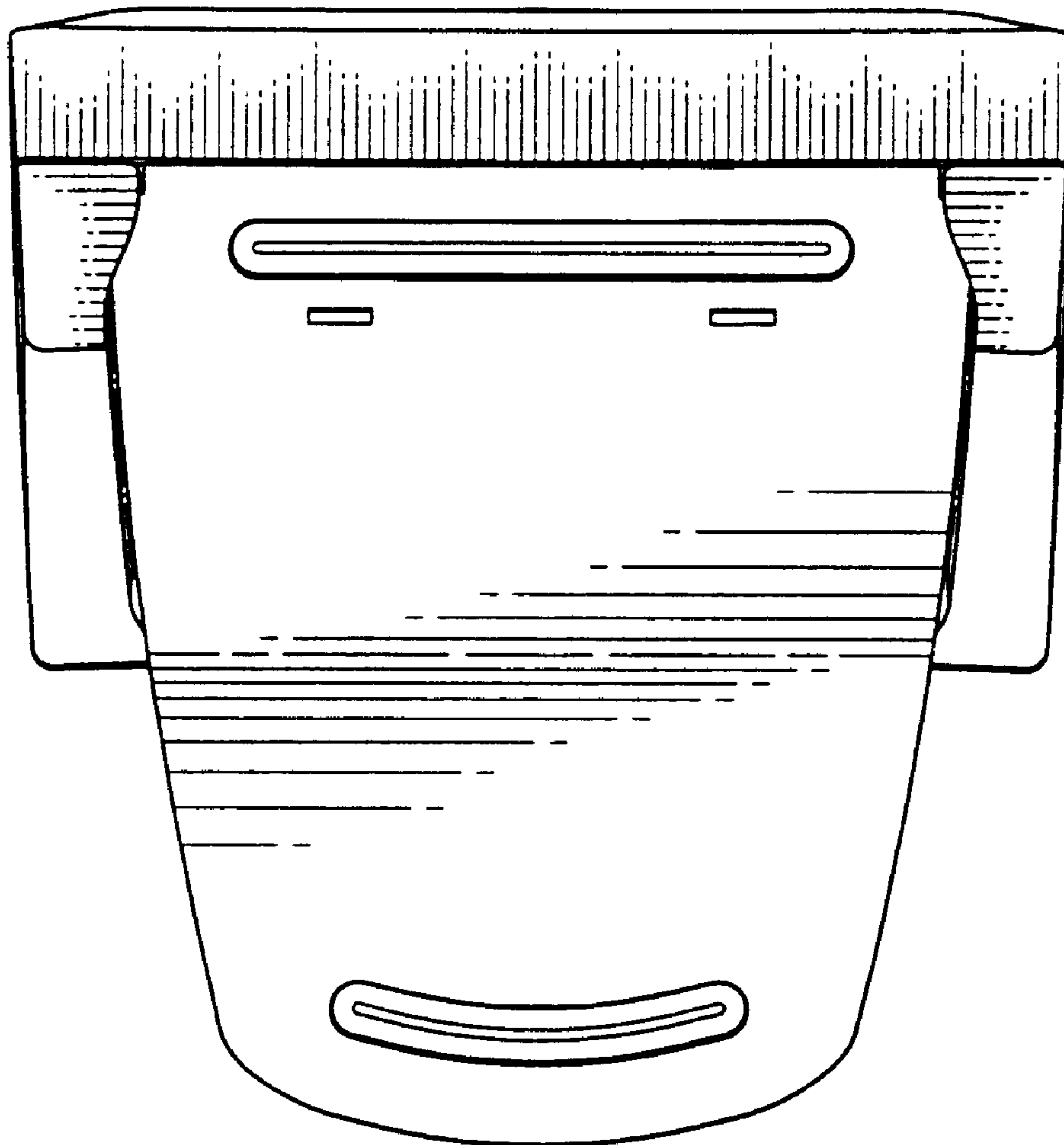

FIG. 7

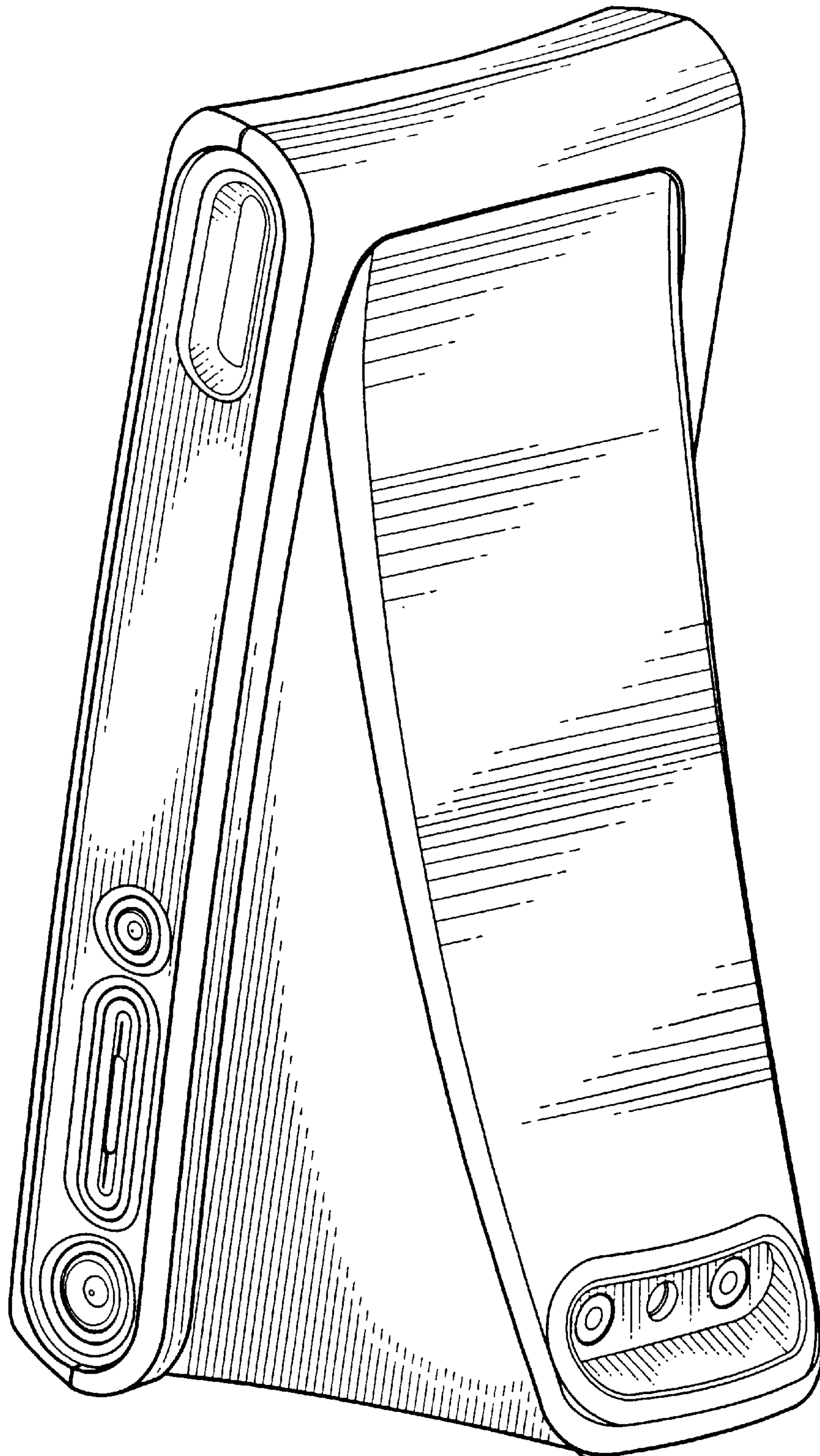

FIG. 8

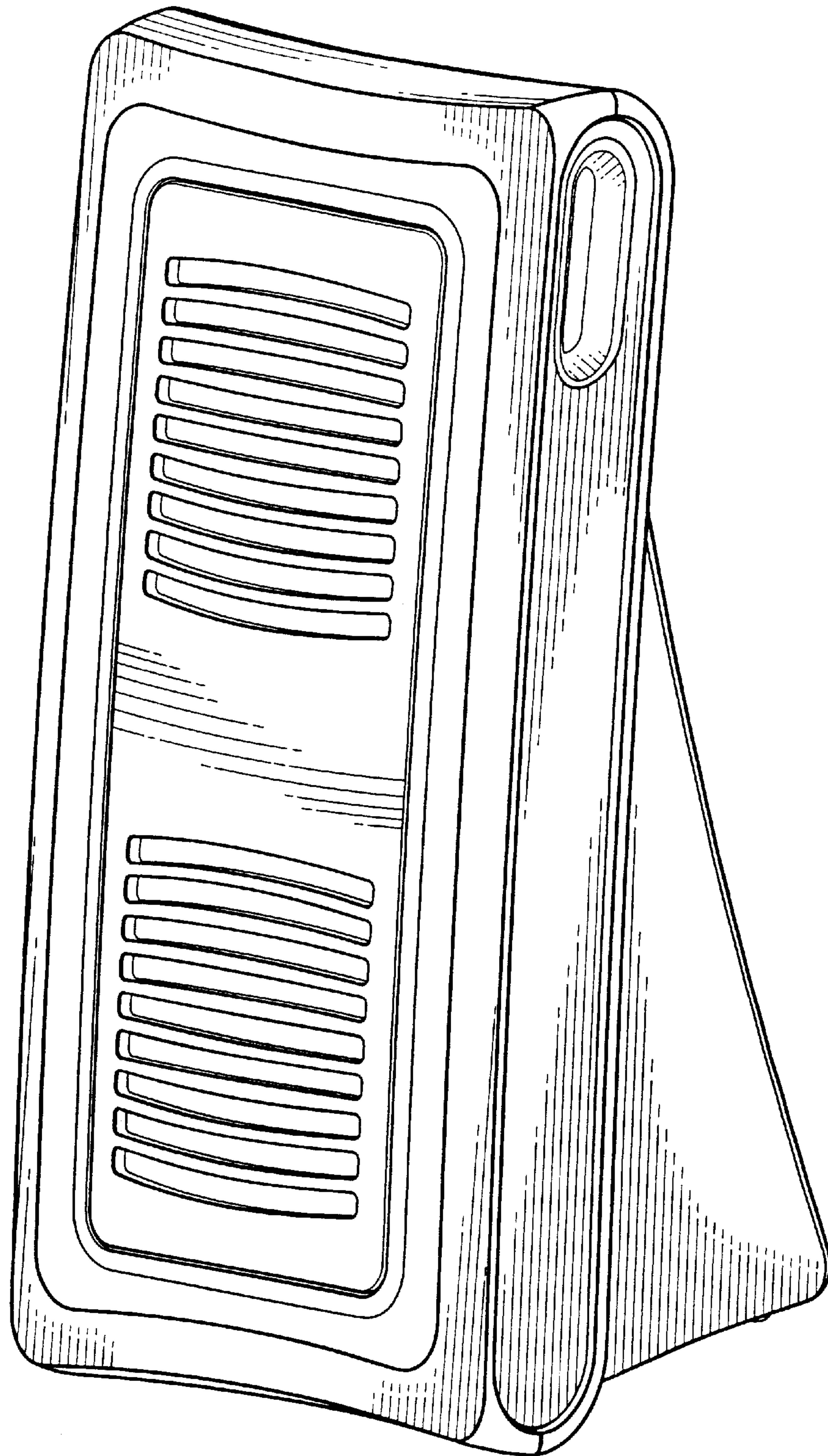

FIG. 9

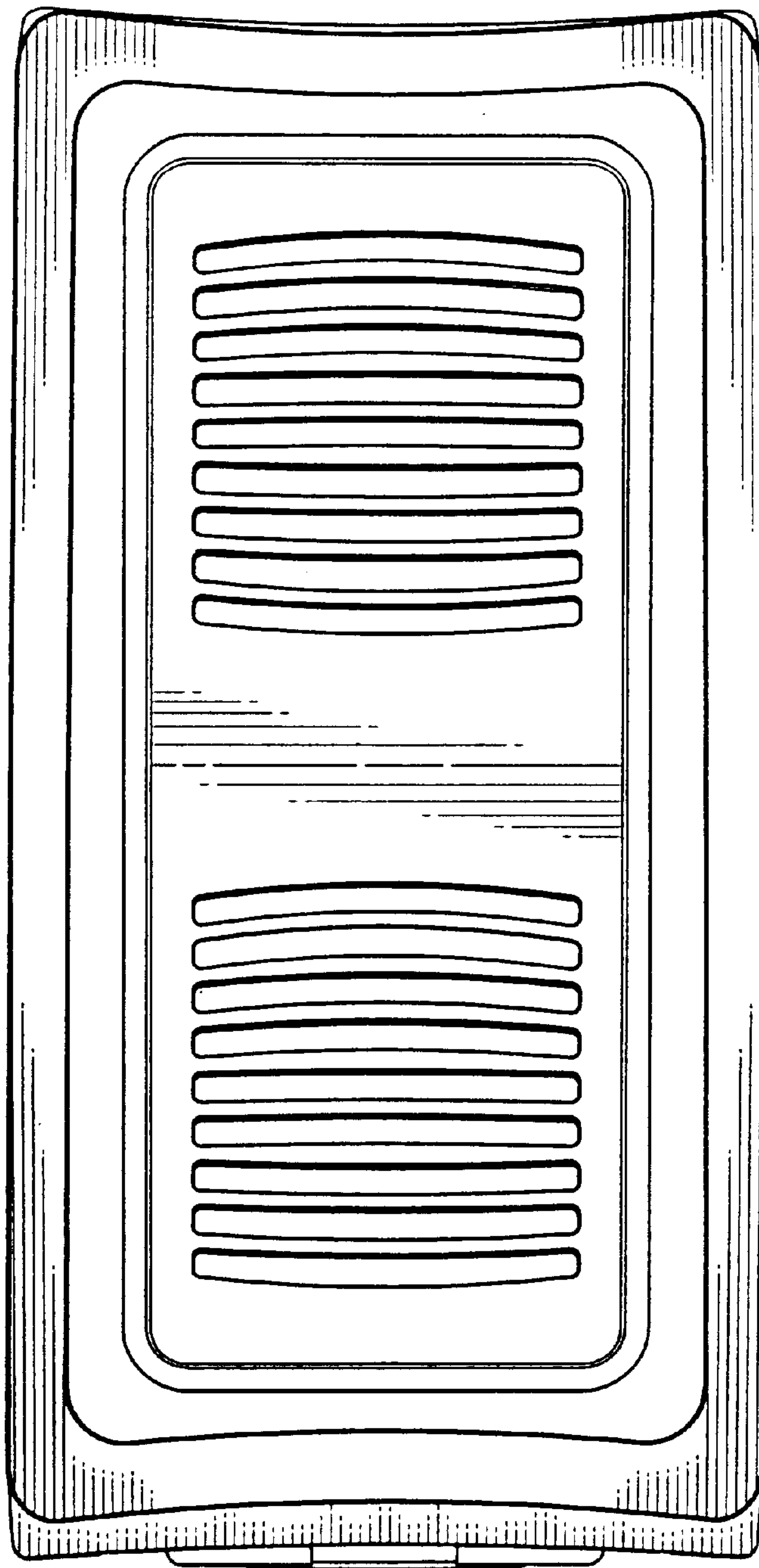

FIG. 10

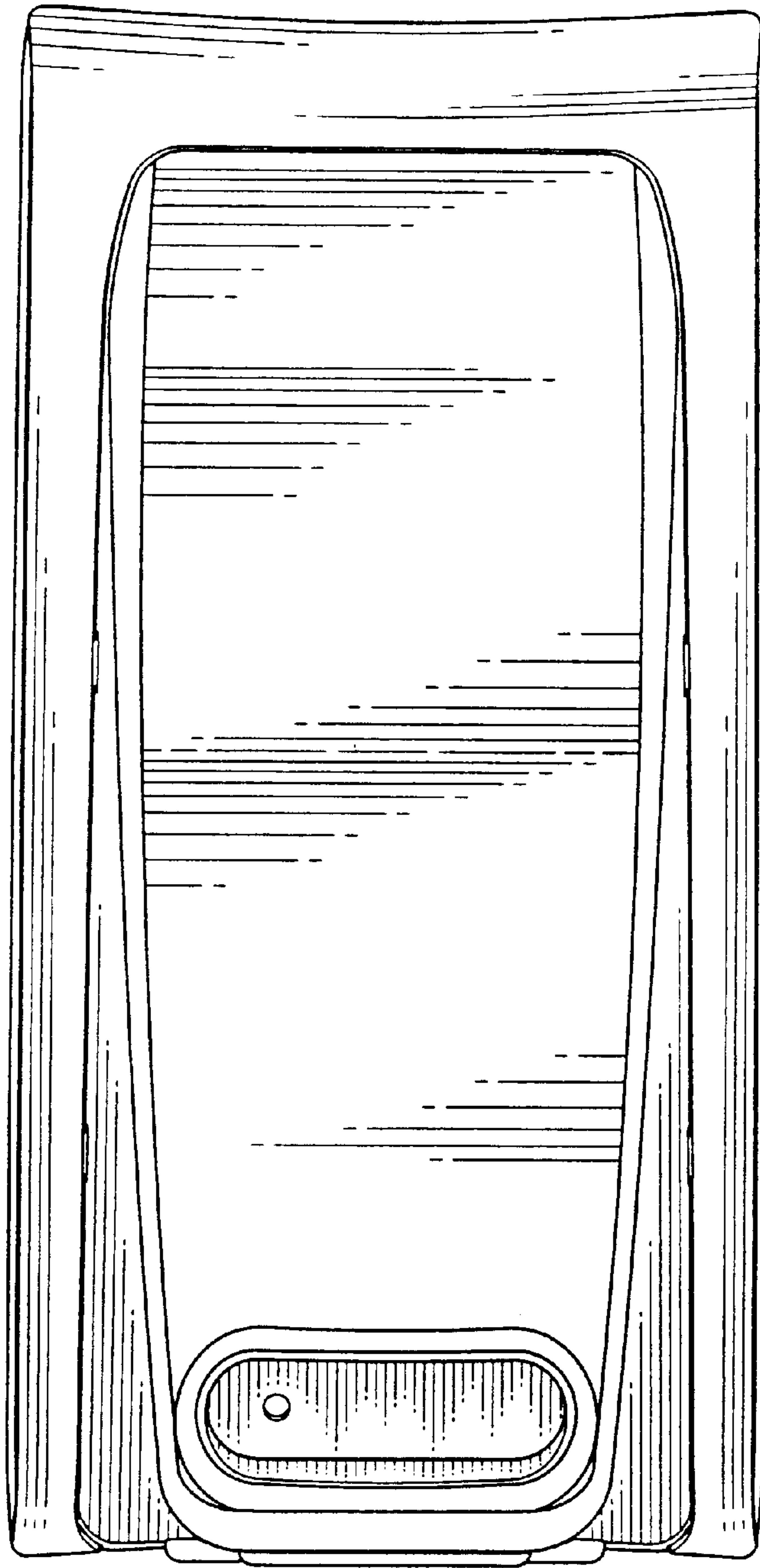

FIG. 11

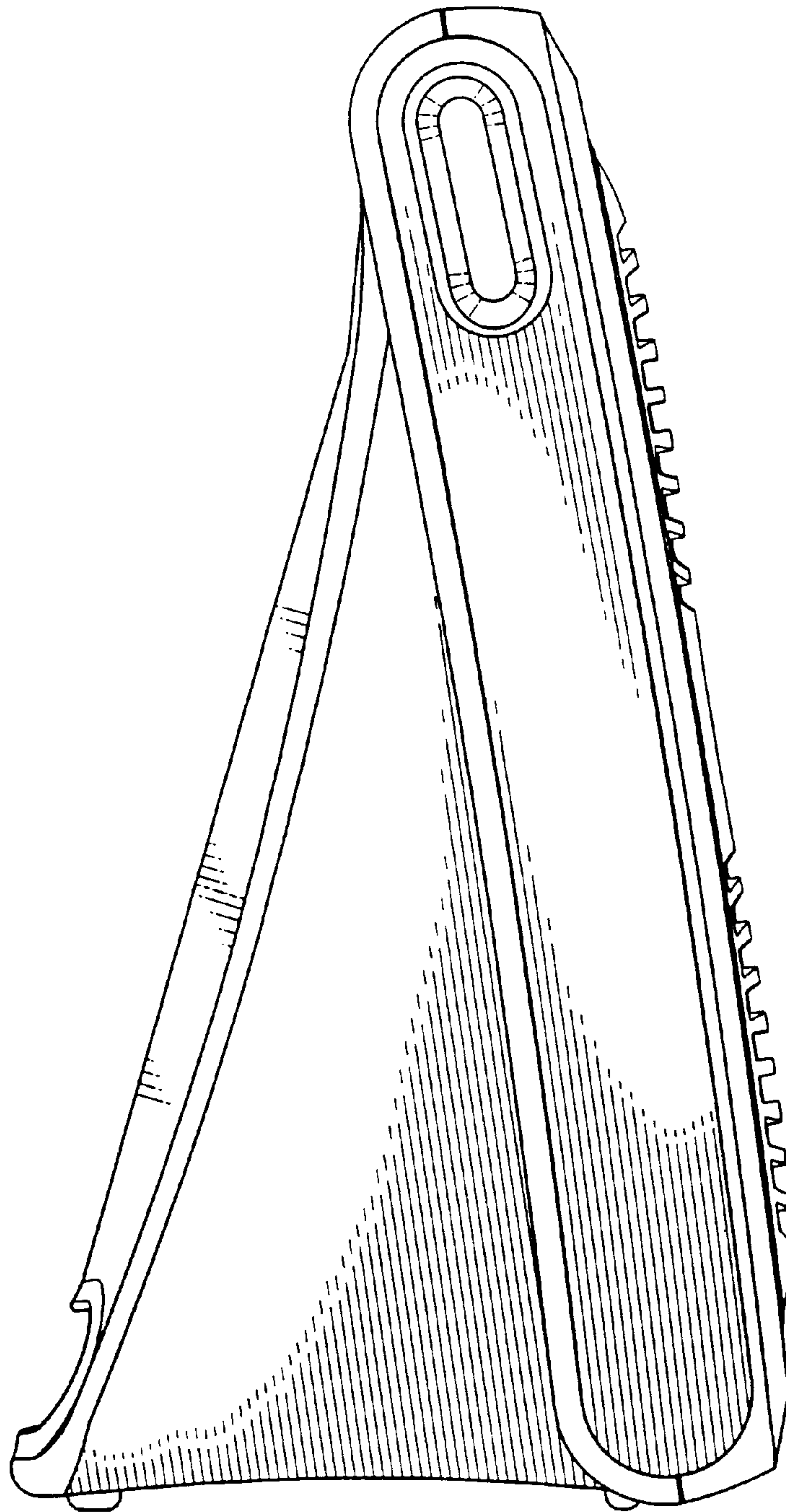

FIG. 12

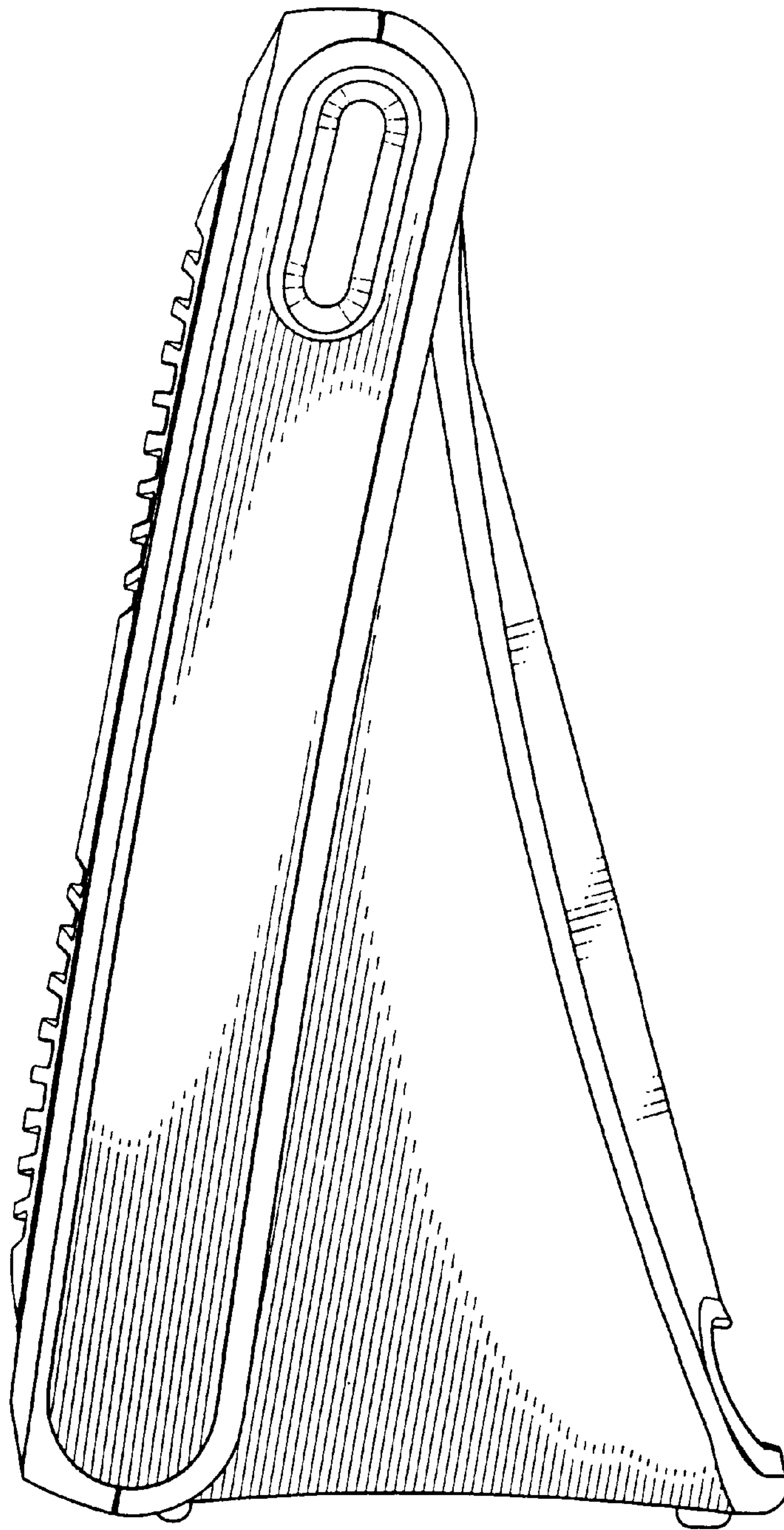

FIG. 13

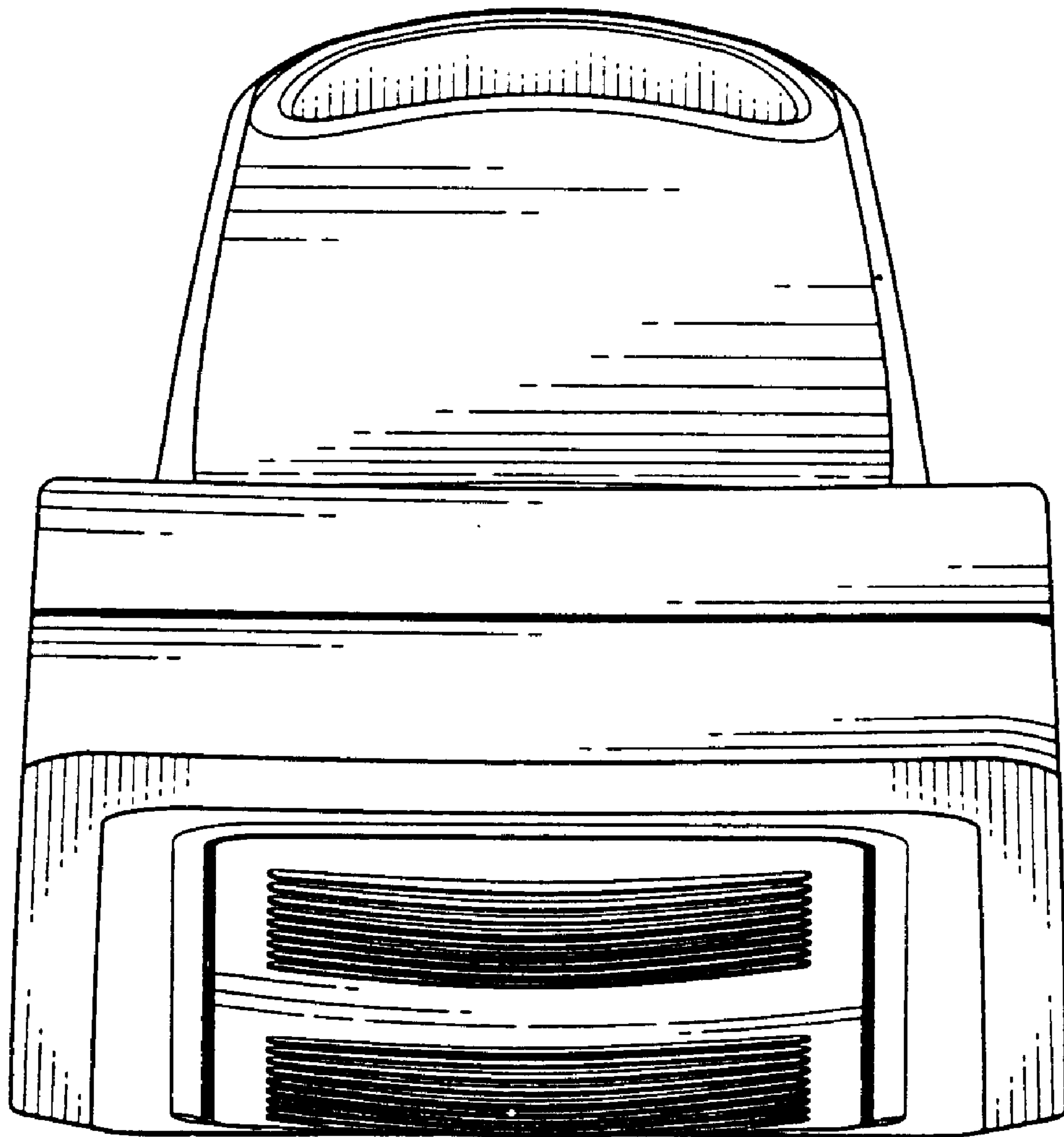

FIG. 14

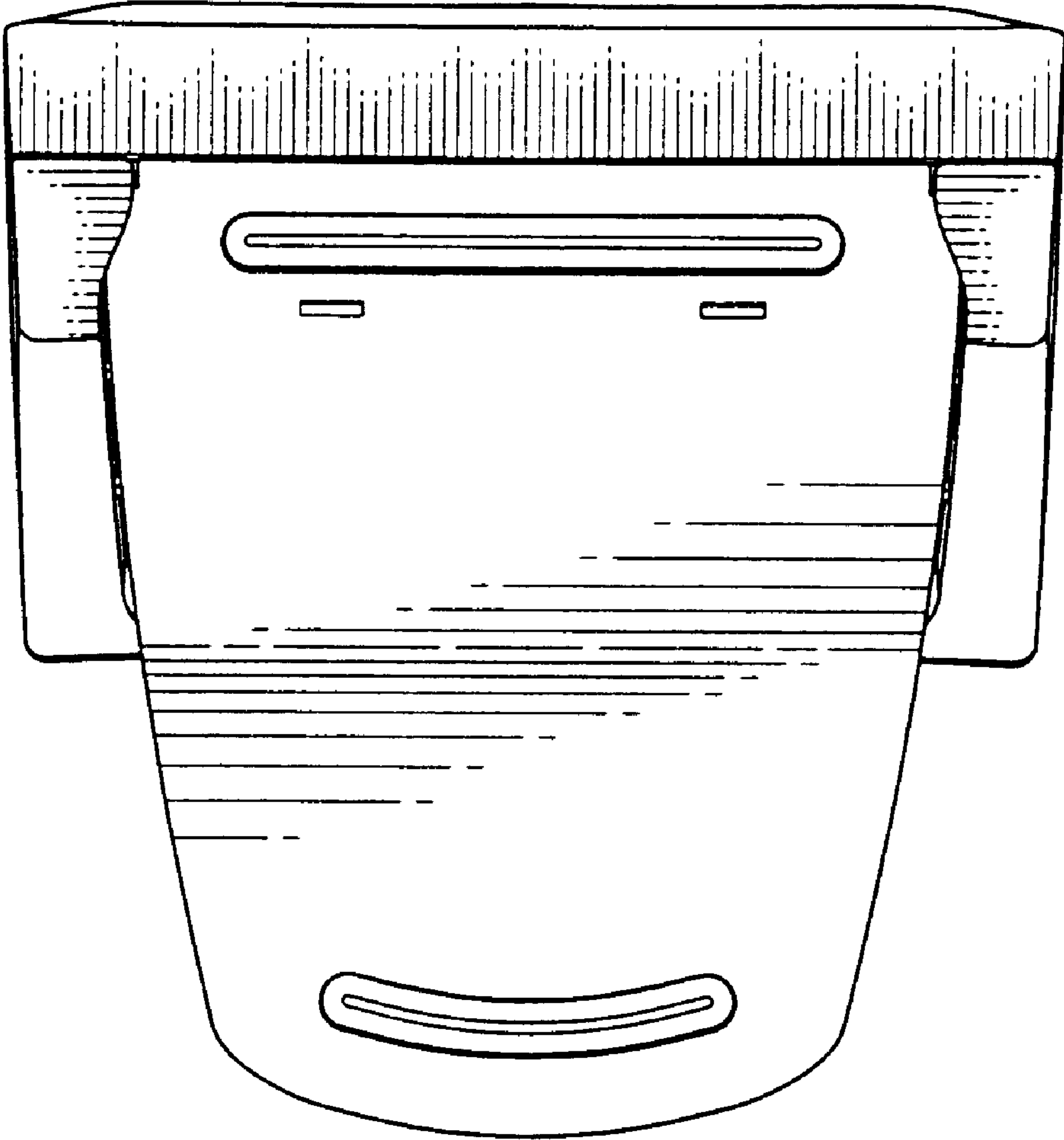

FIG. 15

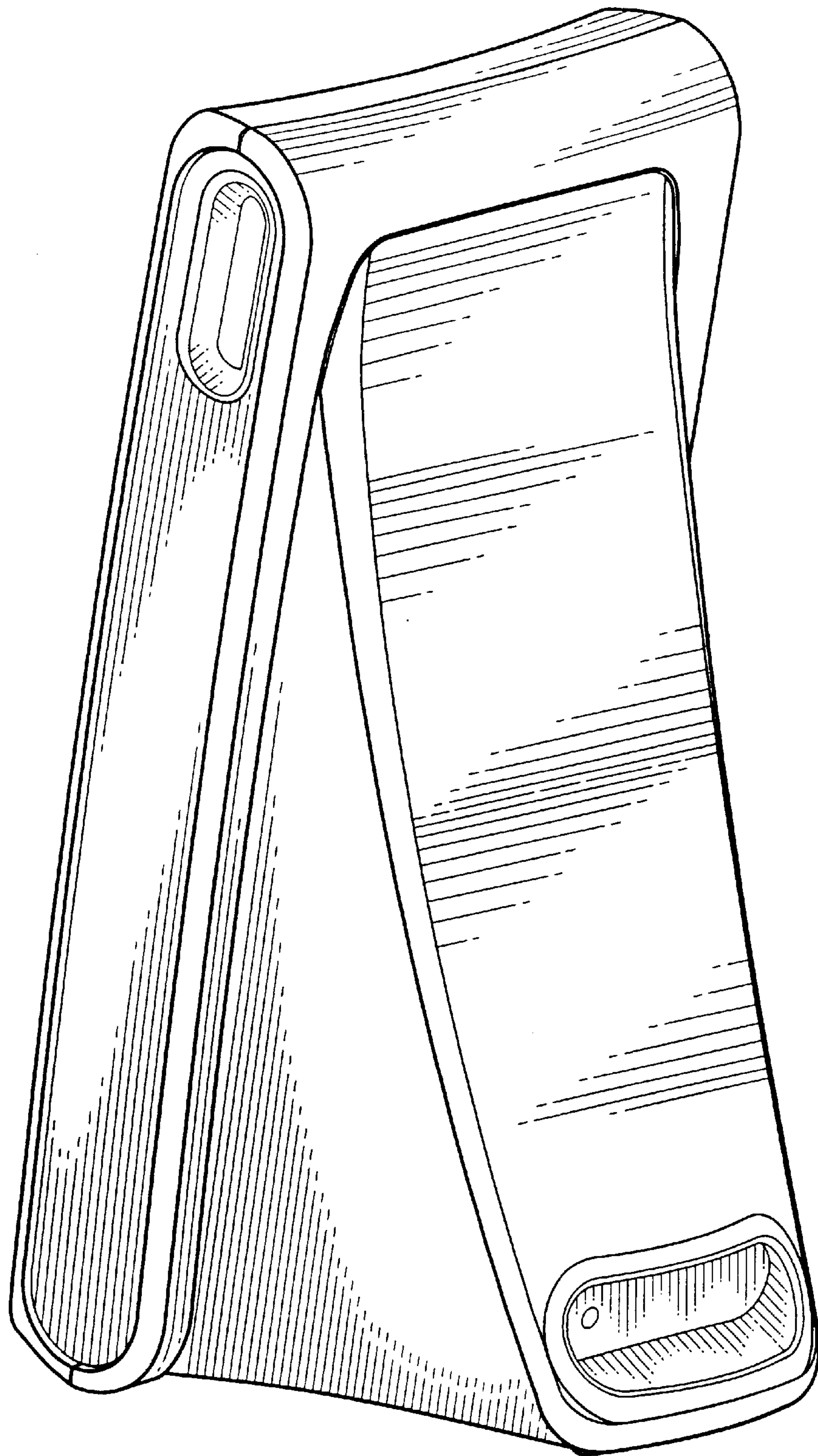

FIG. 16