



US00D497598S1

(12) **United States Design Patent**  
**Kimura et al.**

(10) **Patent No.:** **US D497,598 S**  
(45) **Date of Patent:** **\*\* Oct. 26, 2004**

(54) **ELECTRICAL CONNECTOR**

(75) Inventors: **Akira Kimura**, Kokubunji (JP);  
**Masayuki Kikuchi**, Ome (JP)

(73) Assignee: **Japan Aviation Electronics Industry Limited**, Tokyo (JP)

(\*\*) Term: **14 Years**

(21) Appl. No.: **29/197,843**

(22) Filed: **Jan. 21, 2004**

(30) **Foreign Application Priority Data**

Jul. 24, 2003 (JP) ..... 2003-024873

(51) **LOC (7) Cl.** ..... **13-03**

(52) **U.S. Cl.** ..... **D13/147**

(58) **Field of Search** ..... D13/146, 147,  
D13/59, 60, 74, 78, 79, 83, 108, 181, 260,  
495, 637, 638

(56) **References Cited**

**U.S. PATENT DOCUMENTS**

4,479,686 A \* 10/1984 Hoshino et al. .... 439/78  
4,715,820 A \* 12/1987 Andrews et al. .... 439/59

5,496,180 A \* 3/1996 Fabian et al. .... 439/60  
6,149,468 A \* 11/2000 Meng ..... 439/637  
D451,885 S \* 12/2001 Hisatomi et al. .... D13/147  
D455,127 S \* 4/2002 Wu ..... D13/147

\* cited by examiner

*Primary Examiner*—Stella Reid  
*Assistant Examiner*—Selina Sikder

(74) *Attorney, Agent, or Firm*—Collard & Roe, P.C.

(57) **CLAIM**

The ornamental design for an electrical connector, as shown and described.

**DESCRIPTION**

FIG. 1 is a front elevational view of an electrical connector; FIG. 2 is a top plan view thereof; FIG. 3 is a bottom plan view thereof; FIG. 4 is a rear elevational view thereof; FIG. 5 is a right side elevational view thereof; and, FIG. 6 is a front, top, and right side perspective view thereof. A left side elevational view of the electrical connector is omitted because it is presented symmetrical to the right side elevational view of FIG. 5.

**1 Claim, 3 Drawing Sheets**

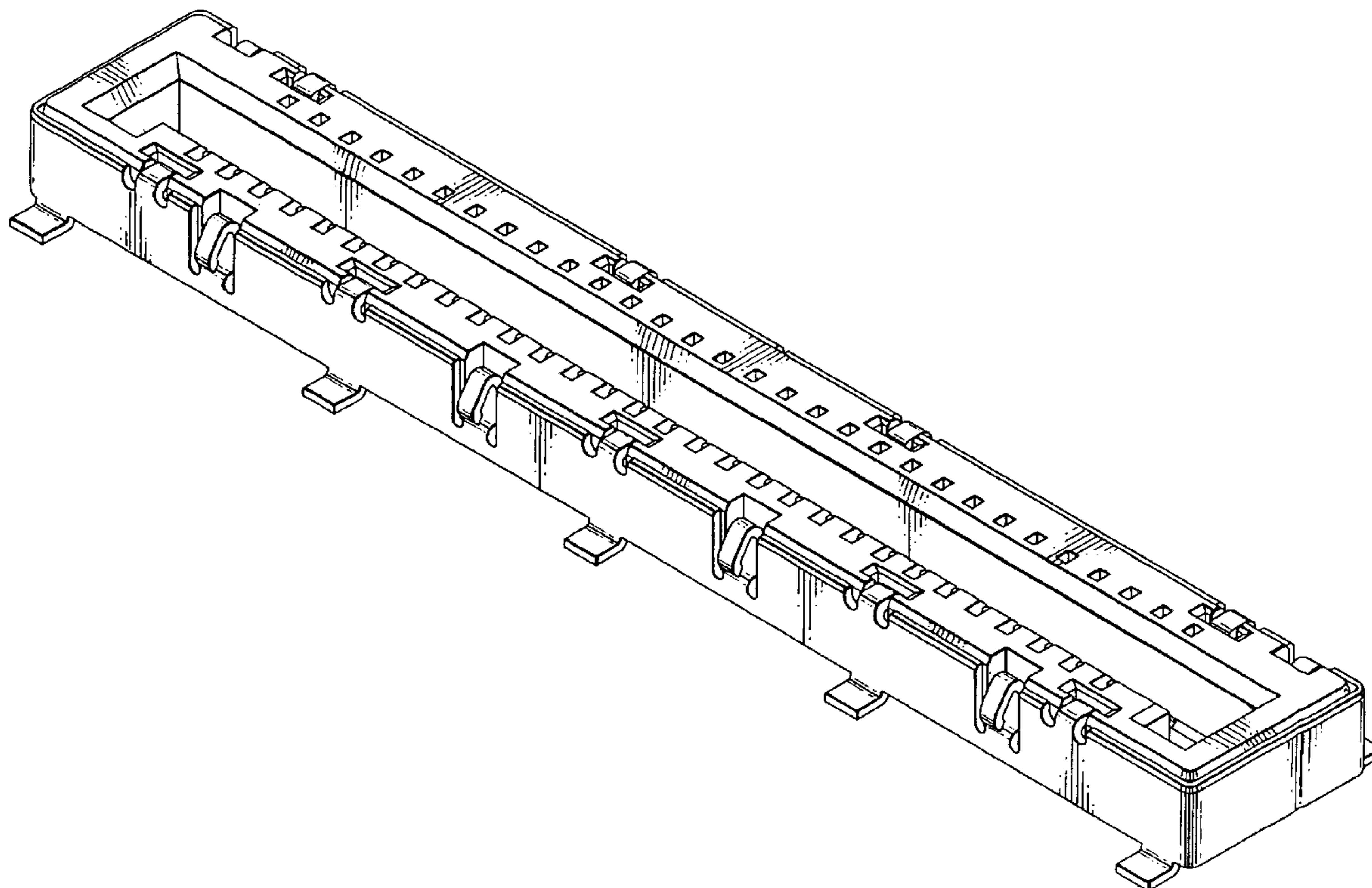

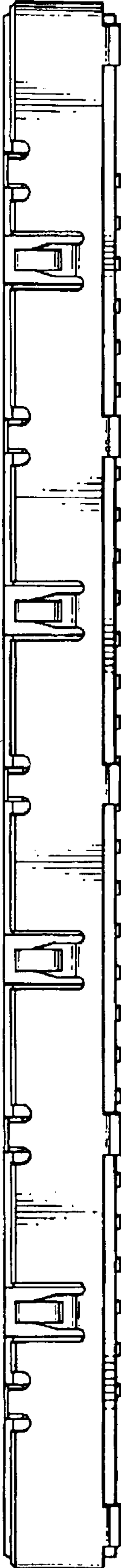

FIG. 1

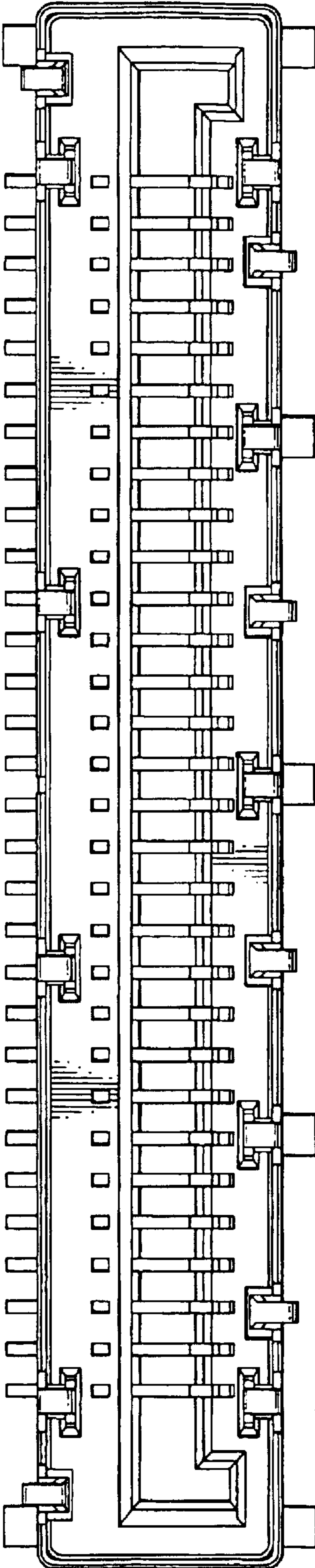

FIG. 2

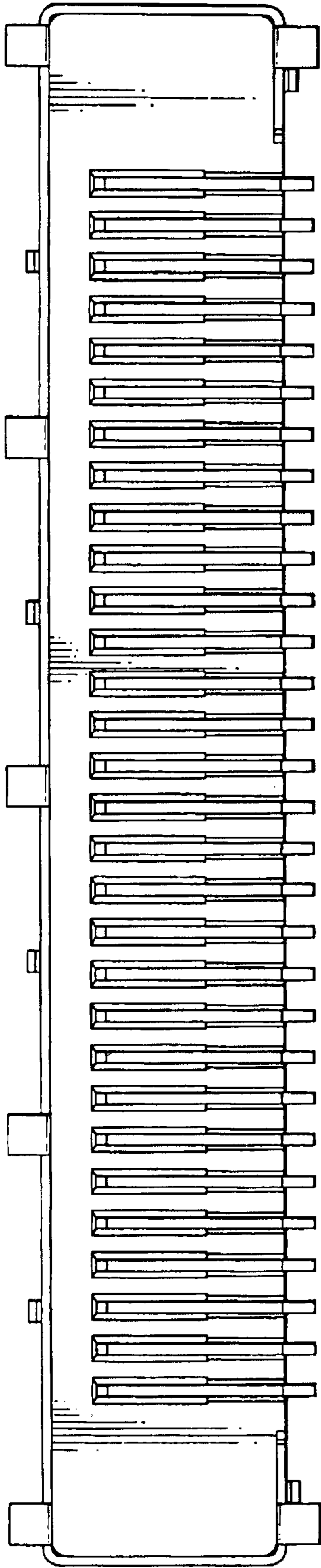

FIG. 3

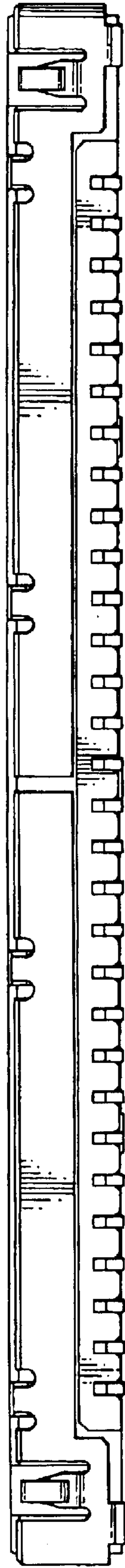

FIG. 4

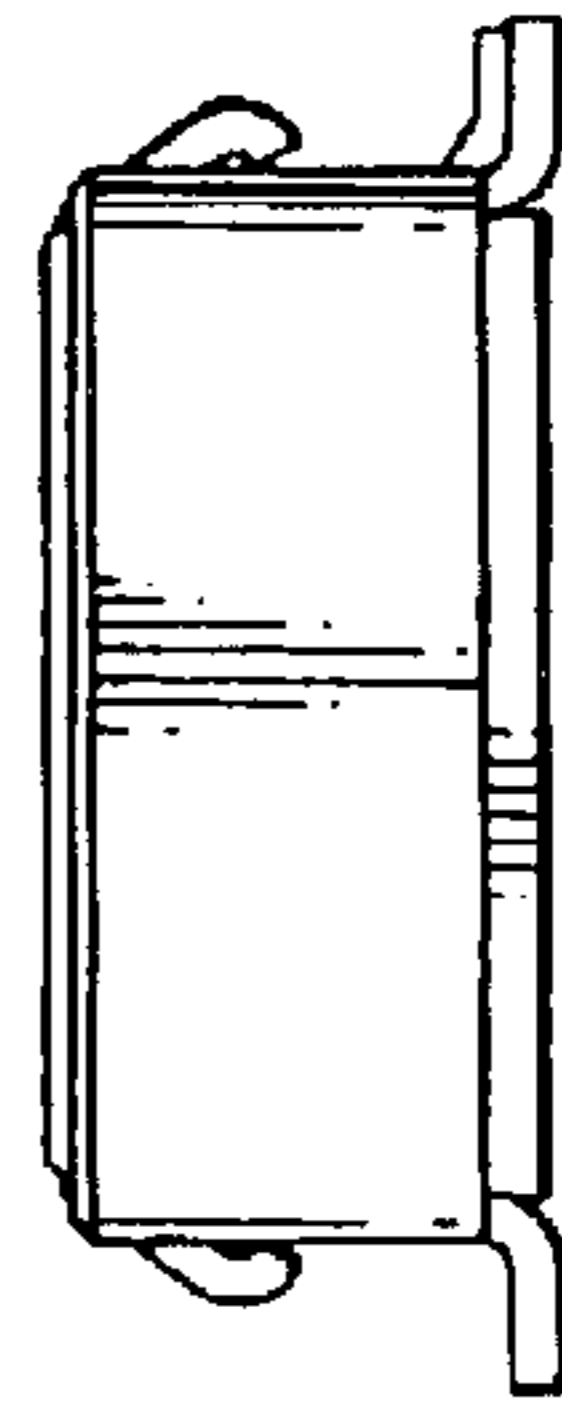

FIG. 5

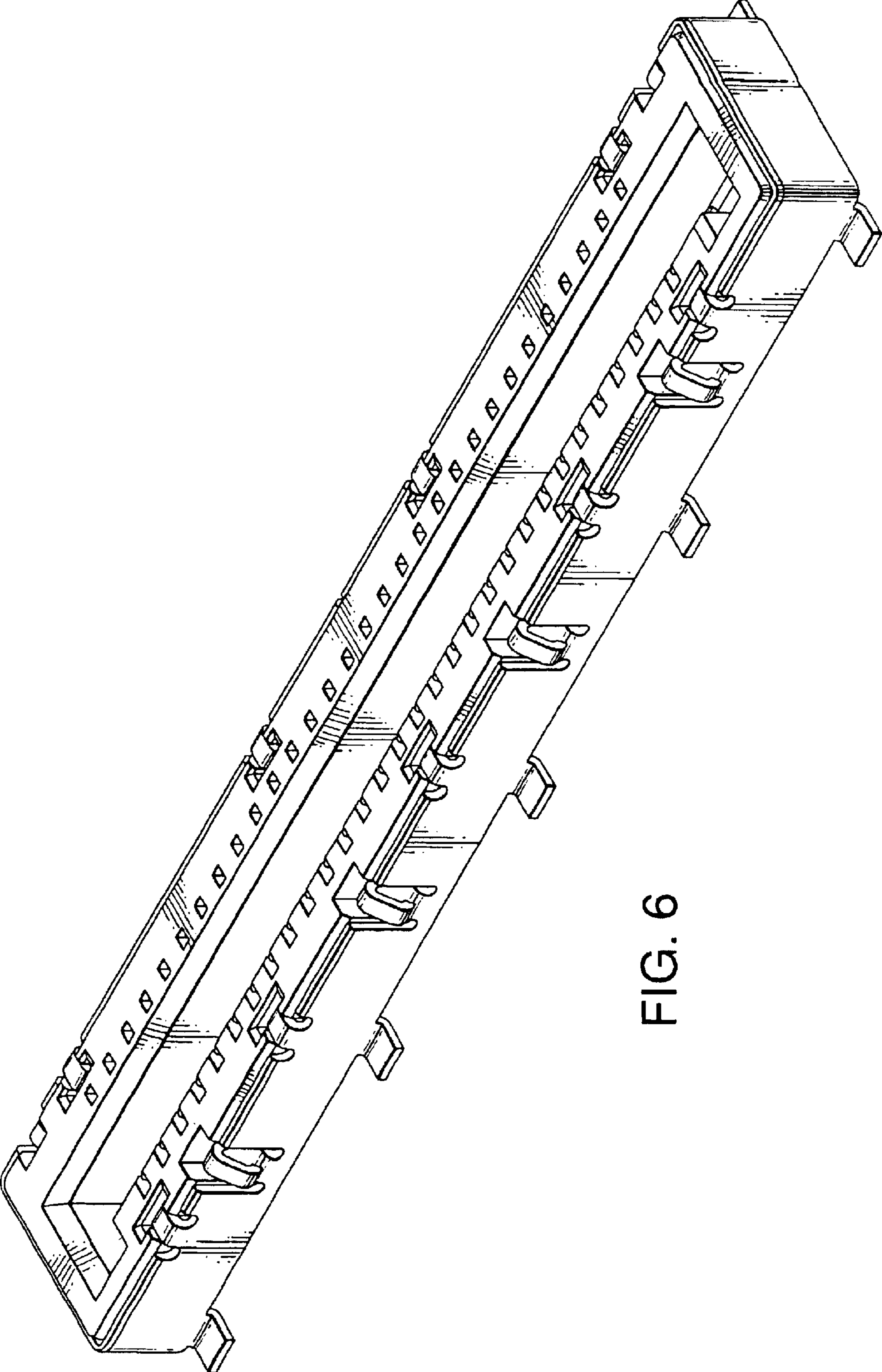

FIG. 6