

US00D497553S1

(12) **United States Design Patent**
Mitchell

(10) **Patent No.:** **US D497,553 S**
(45) **Date of Patent:** **** Oct. 26, 2004**

(54) **FUEL CELL FOR LIQUID CANDLE LAMP**

(75) **Inventor:** **Charles R. K. Mitchell**, Skaneateles,
NY (US)

(73) **Assignee:** **Hollowick, Inc.**, Manlius, NY (US)

(**) **Term:** **14 Years**

(21) **Appl. No.:** **29/181,003**

(22) **Filed:** **May 2, 2003**

(51) **LOC (7) Cl.** **09-01**

(52) **U.S. Cl.** **D9/545; D9/558; D9/560;**
D9/571

(58) **Field of Search** **D9/300, 544, 545,**
D9/546, 549, 558, 560, 510, 571-573, 574;
215/382-384, 396, 398, 400, 12.1-12.3;
D19/93-94; 431/320; D26/9, 8, 117

(56) **References Cited**

U.S. PATENT DOCUMENTS

D36,656 S	*	12/1903	Ritz	D9/560
D91,366 S	*	1/1934	Piazzoll	D9/560
D103,050 S	*	2/1937	Higgins	D9/560
D128,491 S	*	7/1941	Hoch	D9/545
D152,211 S	*	12/1948	Platt	D9/560 X
D214,663 S	*	7/1969	Brickey, Jr.	D9/560
D317,059 S		5/1991	Menter		
D345,920 S	*	4/1994	Gobe	D9/571

D355,602 S	*	2/1995	Buettner et al.	D9/545 X
D391,494 S	*	3/1998	Bond	D9/546
D395,605 S	*	6/1998	Kokenge	D9/571
D400,797 S	*	11/1998	de Mourgues	D9/558
D420,462 S		2/2000	Menter		
D421,912 S	*	3/2000	Nosella	D9/560
D448,867 S		10/2001	Manocheo et al.		
D469,361 S	*	1/2003	Zhou	D9/560

* cited by examiner

Primary Examiner—Carol Rademaker

(74) *Attorney, Agent, or Firm*—Wall Marjama & Bilinski
LLP

(57) **CLAIM**

The ornamental design for a fuel cell for a liquid candle lamp, as shown and described.

DESCRIPTION

FIG. 1 is a front perspective view of a fuel cell embodying my new Design;

FIG. 2 is a front side view thereof; the right side, left side and back side view being identical;

FIG. 3 is a bottom view thereof;

FIG. 4 is a top view thereof;

FIG. 5 is a section view taken along lines 5—5 in FIG. 4; and,

FIG. 6 is a section view taken along lines 6—6 in FIG. 4.

1 Claim, 2 Drawing Sheets

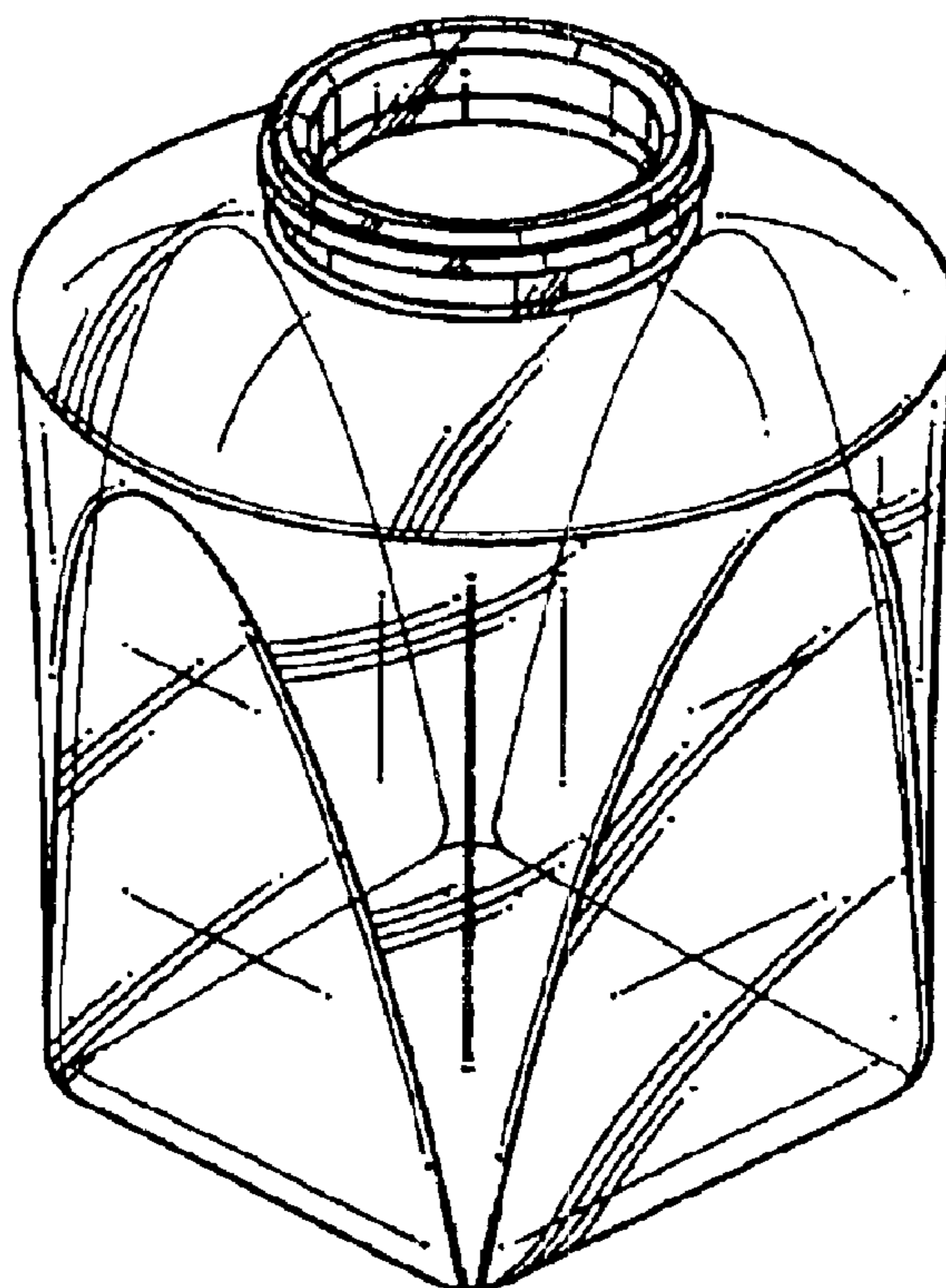

FIG.1

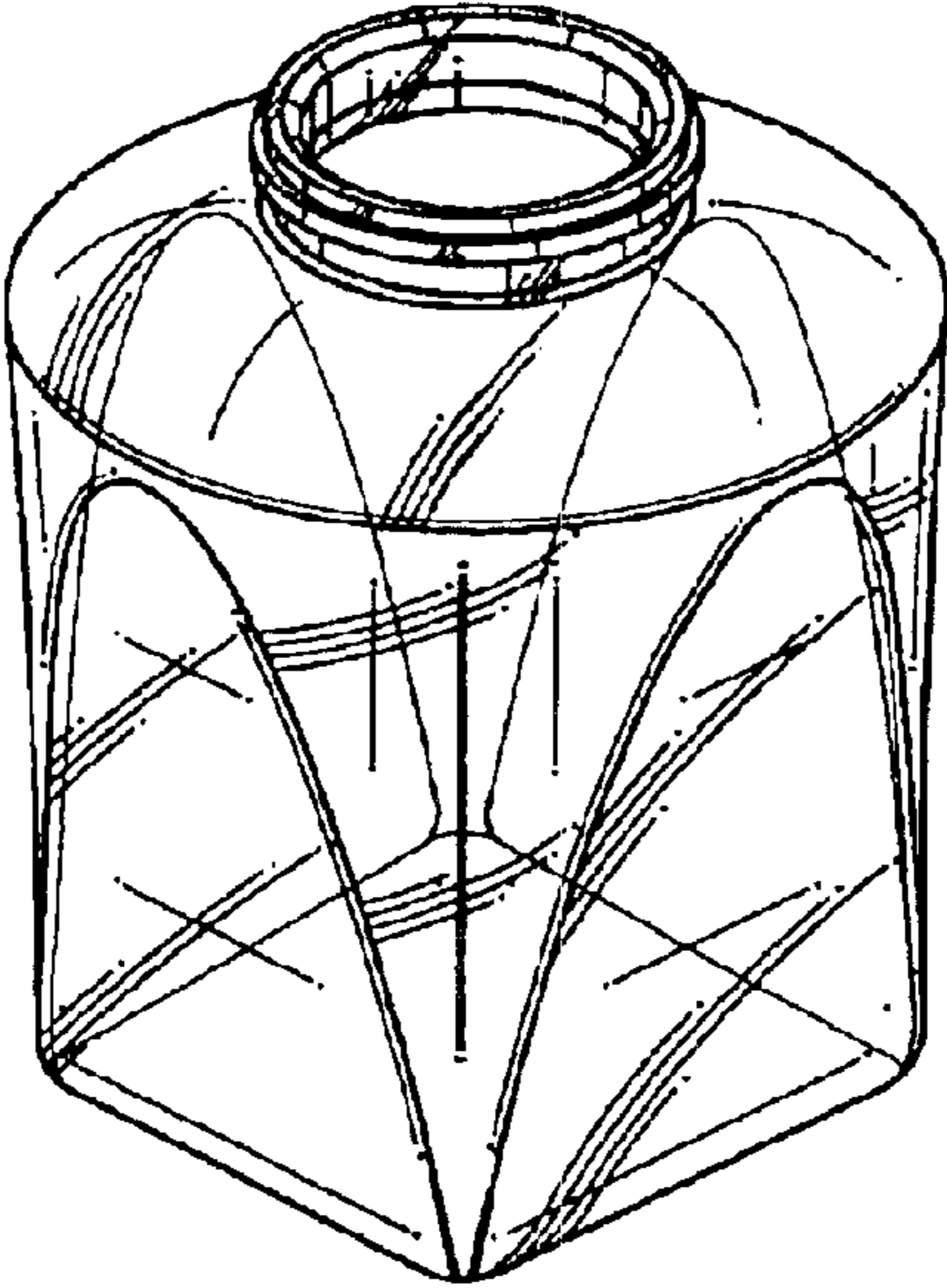

FIG.2

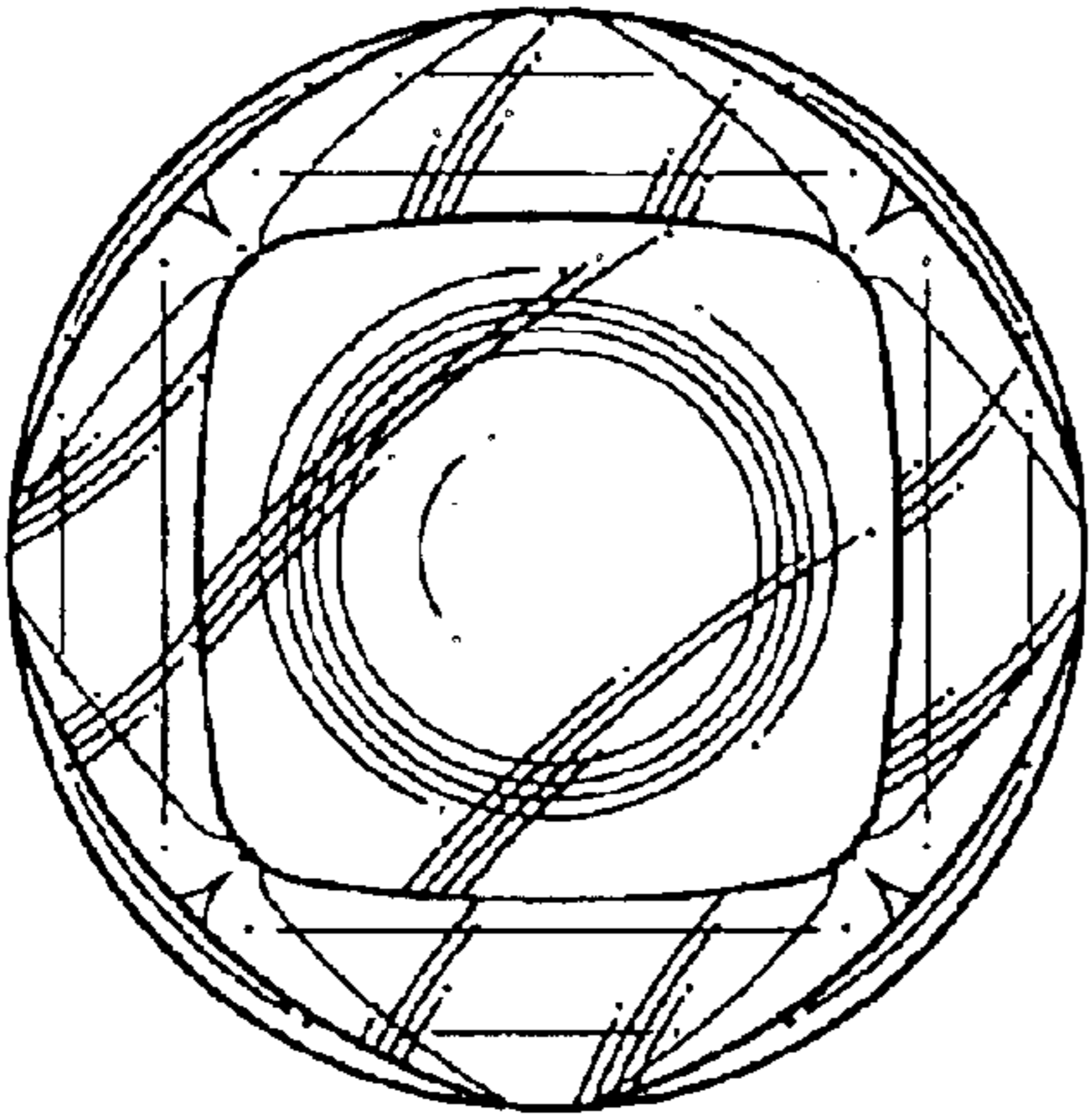
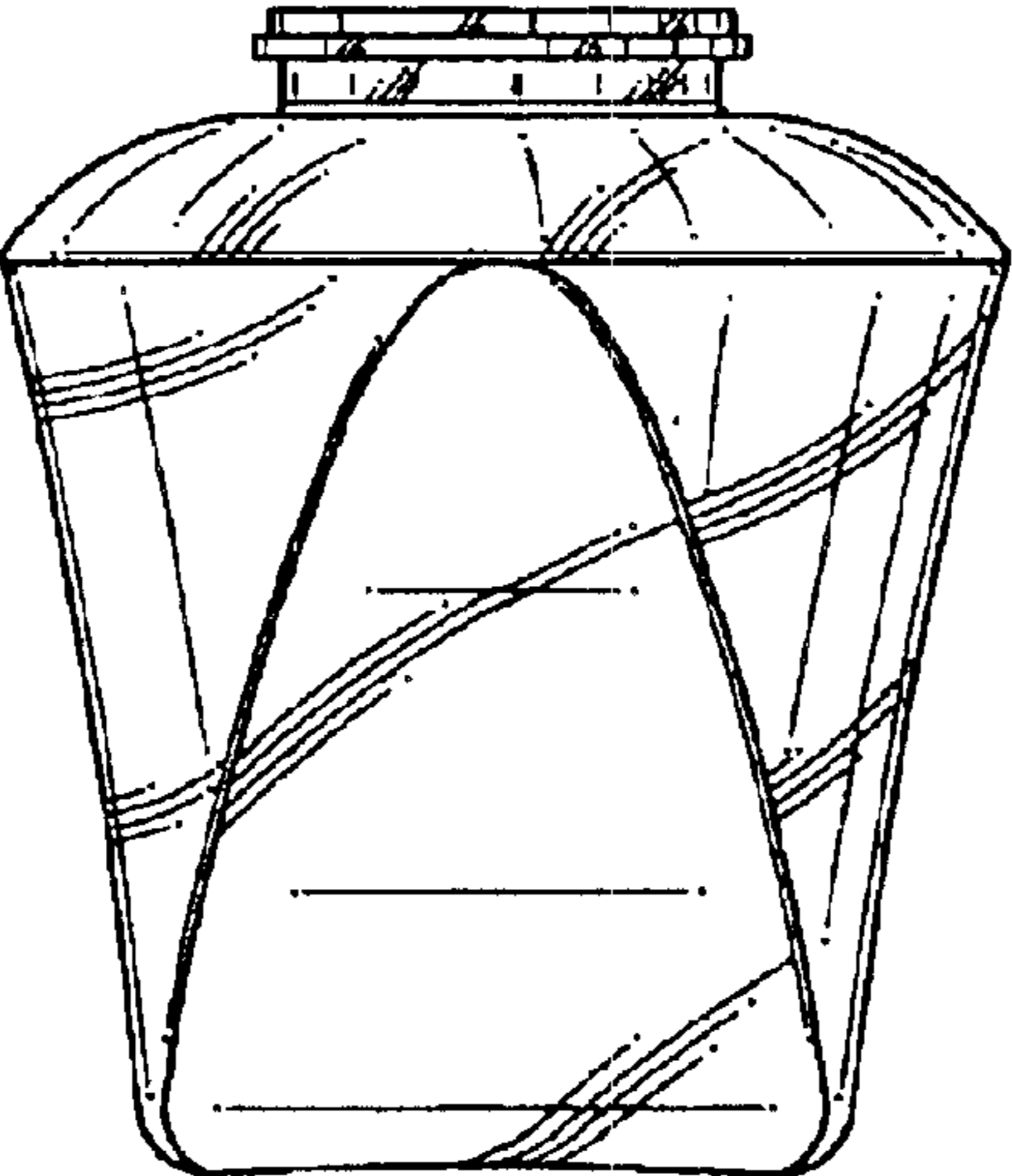

FIG.3

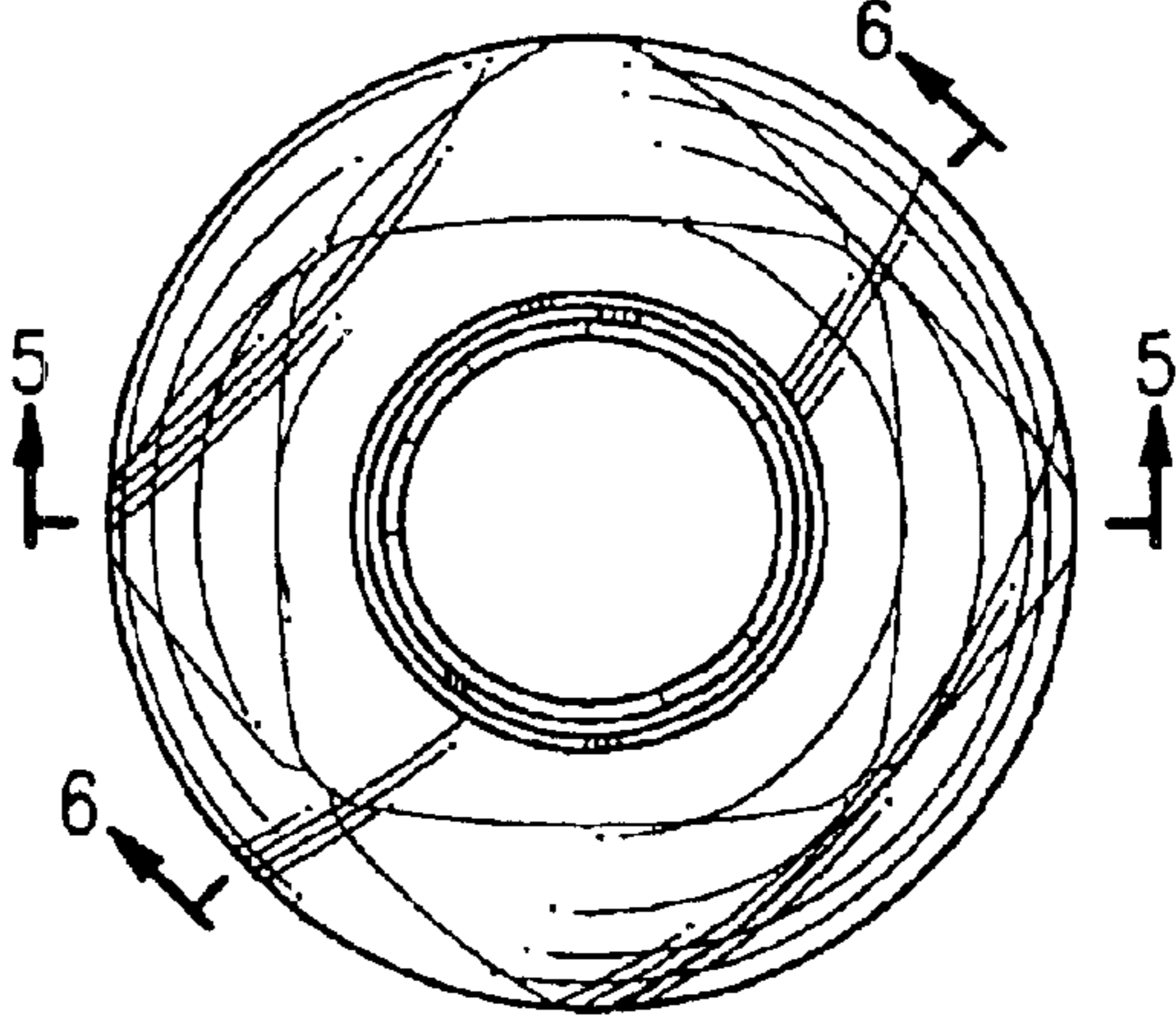

FIG.4

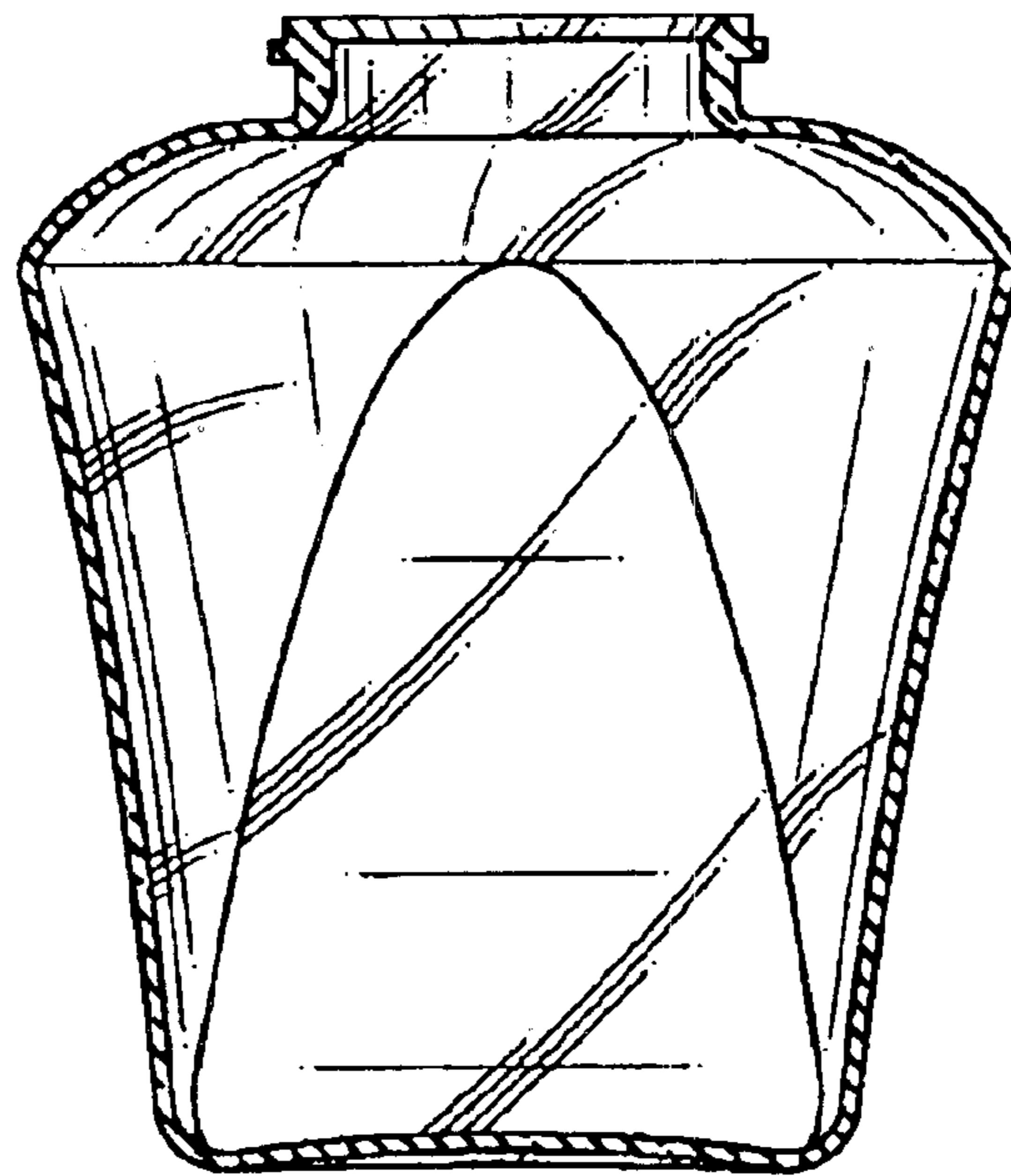

FIG. 5

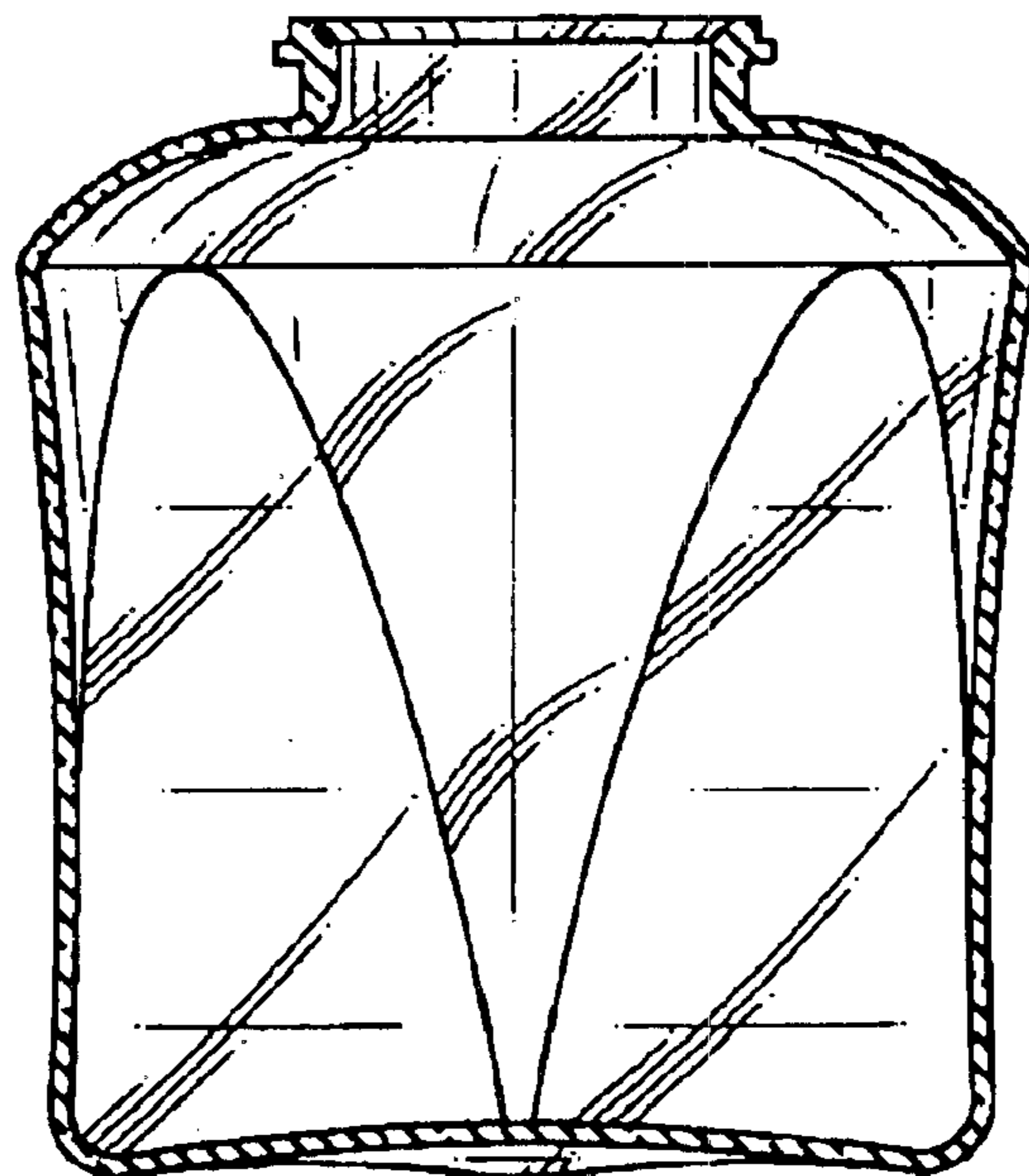

FIG. 6