

US00D497511S1

(12) **United States Design Patent**
Lebowitz

(10) **Patent No.: US D497,511 S**
(45) **Date of Patent: ** Oct. 26, 2004**

(54) **TEA KETTLE**

(75) Inventor: **Samuel Lebowitz**, Shelter Island, NY
(US)

(73) Assignee: **Wilton Industries, Inc.**, Woodridge, IL
(US)

(**) Term: **14 Years**

(21) Appl. No.: **29/175,993**

(22) Filed: **Feb. 14, 2003**

(51) **LOC (7) Cl. 07-01**

(52) **U.S. Cl. D7/322; D7/321**

(58) **Field of Search D7/300, 312, 321,**
D7/322, 320; 220/756; 222/472, 482, 475;
116/67 R

(56) **References Cited**

U.S. PATENT DOCUMENTS

- 4,385,585 A * 5/1983 Lebowitz 116/67 R
- D274,594 S * 7/1984 Lebowitz D7/320
- D274,595 S * 7/1984 Lebowitz D7/322
- D277,253 S * 1/1985 Lax D7/320
- D282,810 S * 3/1986 Urich D7/322

- D336,006 S * 6/1993 Lebowitz D7/322
- D361,692 S * 8/1995 Lee D7/322
- D407,943 S * 4/1999 Chen D7/322
- D435,386 S * 12/2000 Ancona et al. D7/322
- D435,997 S * 1/2001 Leo et al. D7/322
- D478,243 S * 8/2003 Lebowitz D7/322
- D478,767 S * 8/2003 Lebowitz D7/322
- D478,768 S * 8/2003 Belton D7/322

* cited by examiner

Primary Examiner—M. N. Pandozzi

(74) *Attorney, Agent, or Firm*—Piper Rudnick LLP

(57) **CLAIM**

The ornamental design for the tea kettle, as shown.

DESCRIPTION

FIG. 1 is a front perspective view of the tea kettle;
 FIG. 2 is a front elevational view of the tea kettle;
 FIG. 3 is a back elevational view of the tea kettle;
 FIG. 4 is a right side elevational view of the tea kettle;
 FIG. 5 is a left side elevational view of the tea kettle;
 FIG. 6 is a top plan view of the tea kettle; and,
 FIG. 7 is a bottom plan view of the tea kettle.

1 Claim, 4 Drawing Sheets

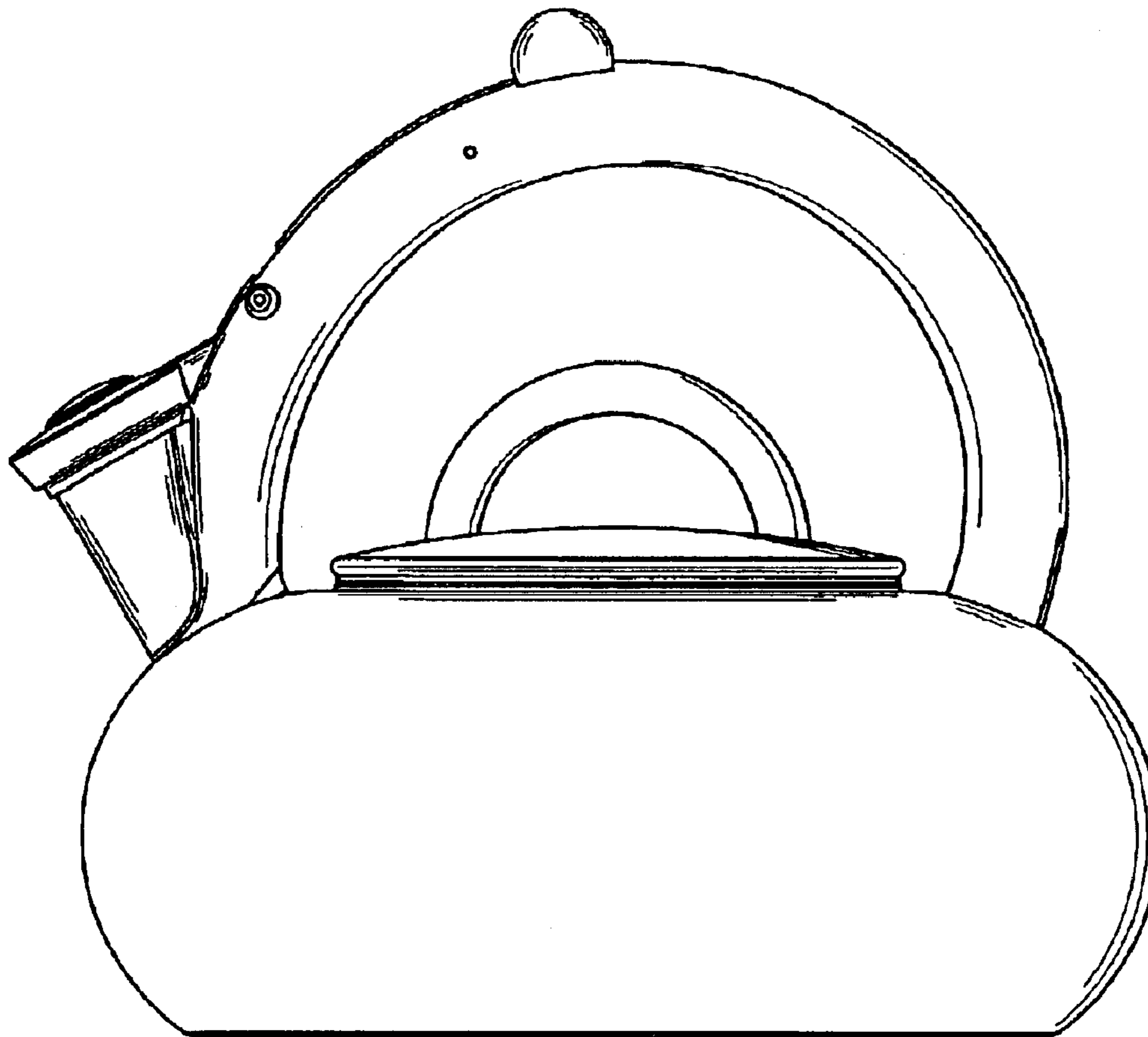

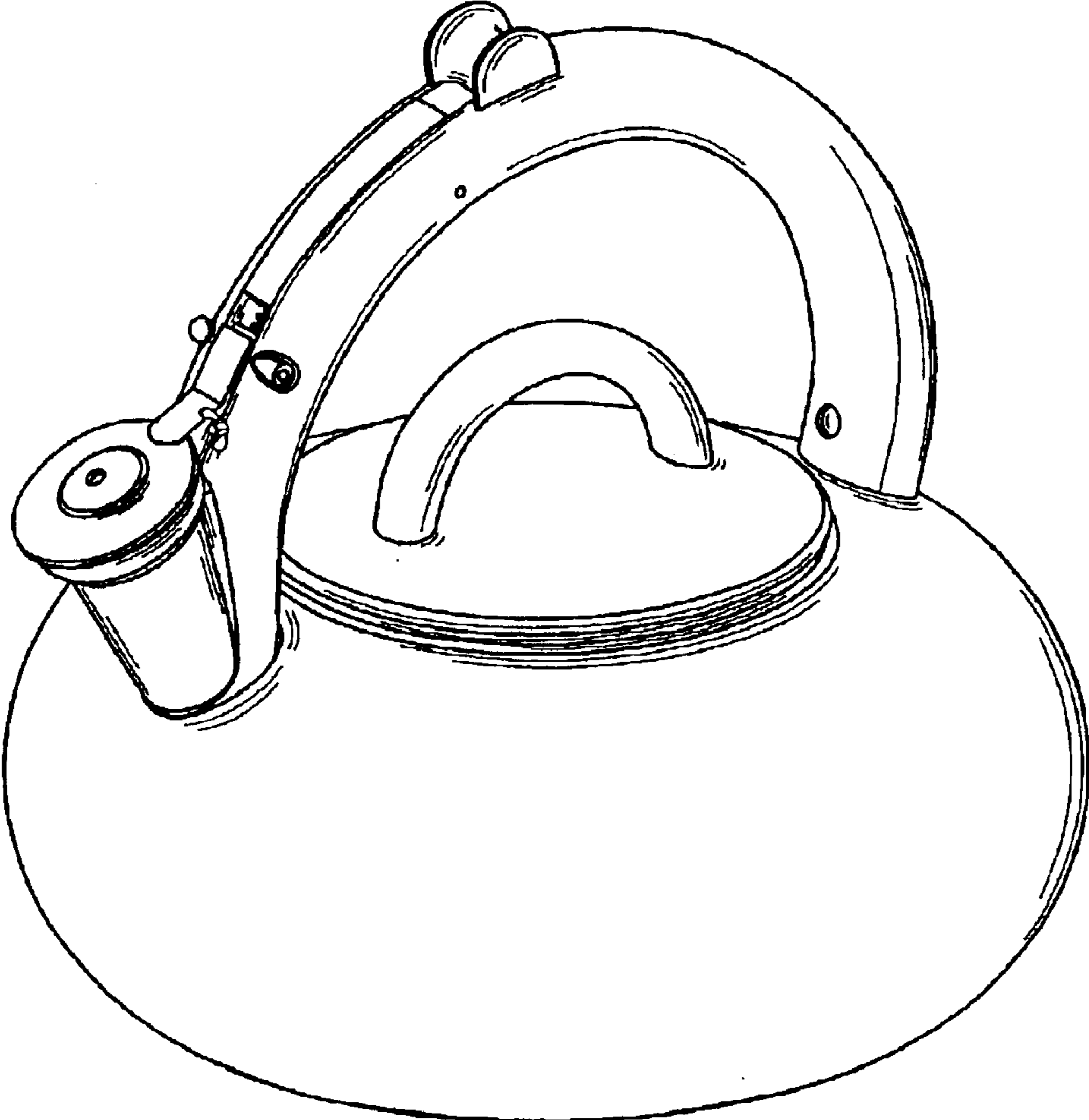

FIG. 1

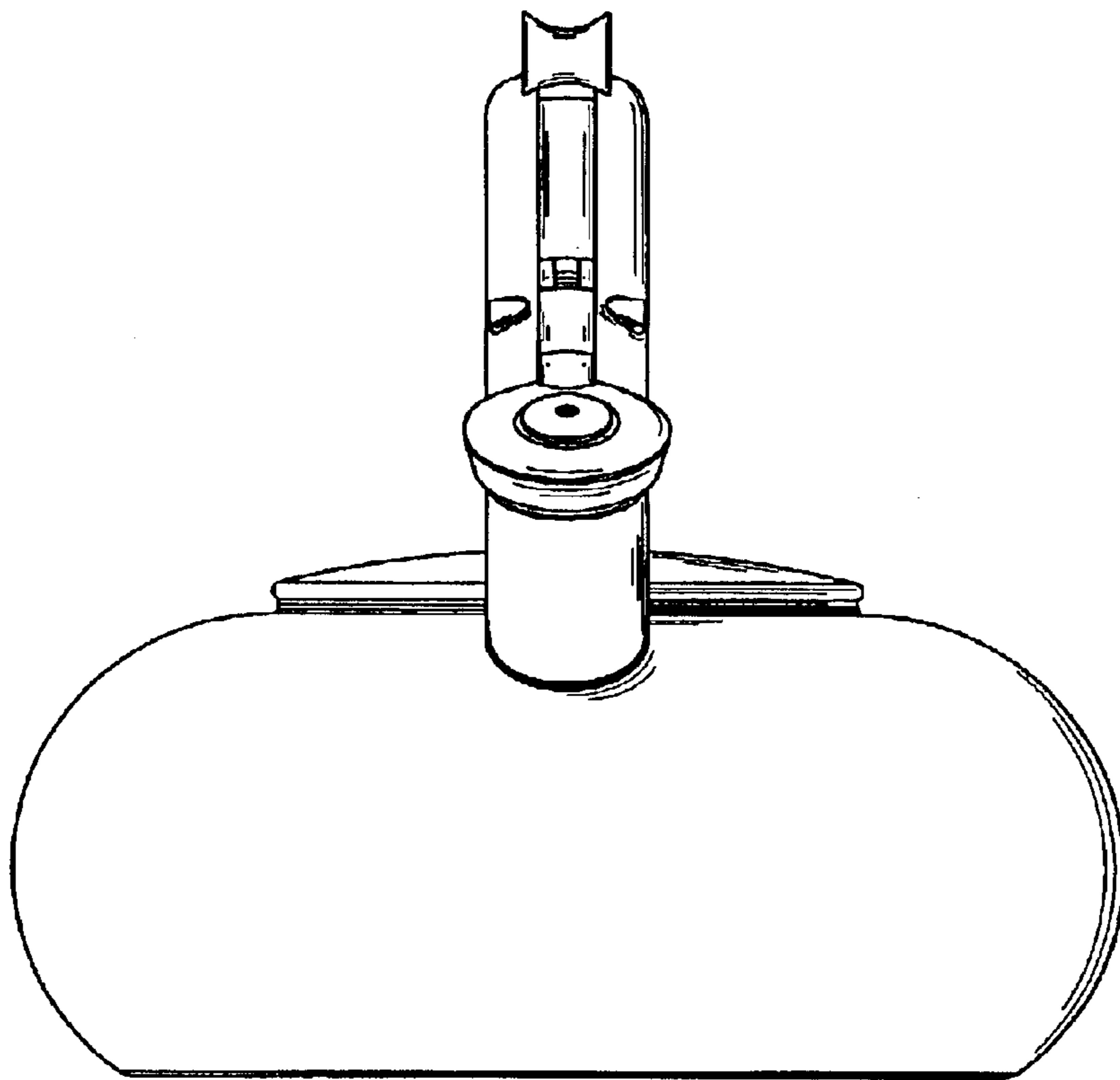

FIG. 2

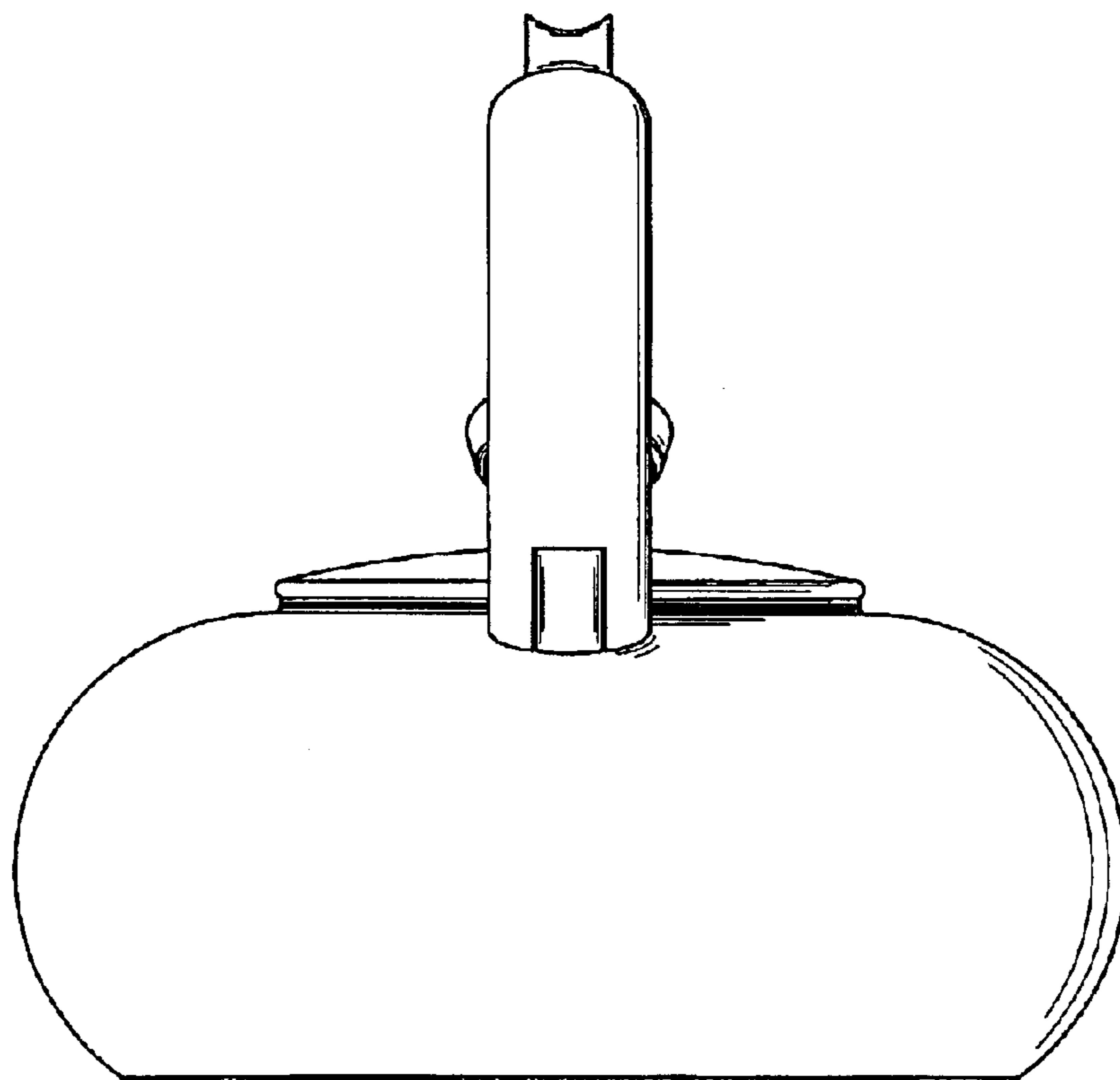

FIG. 3

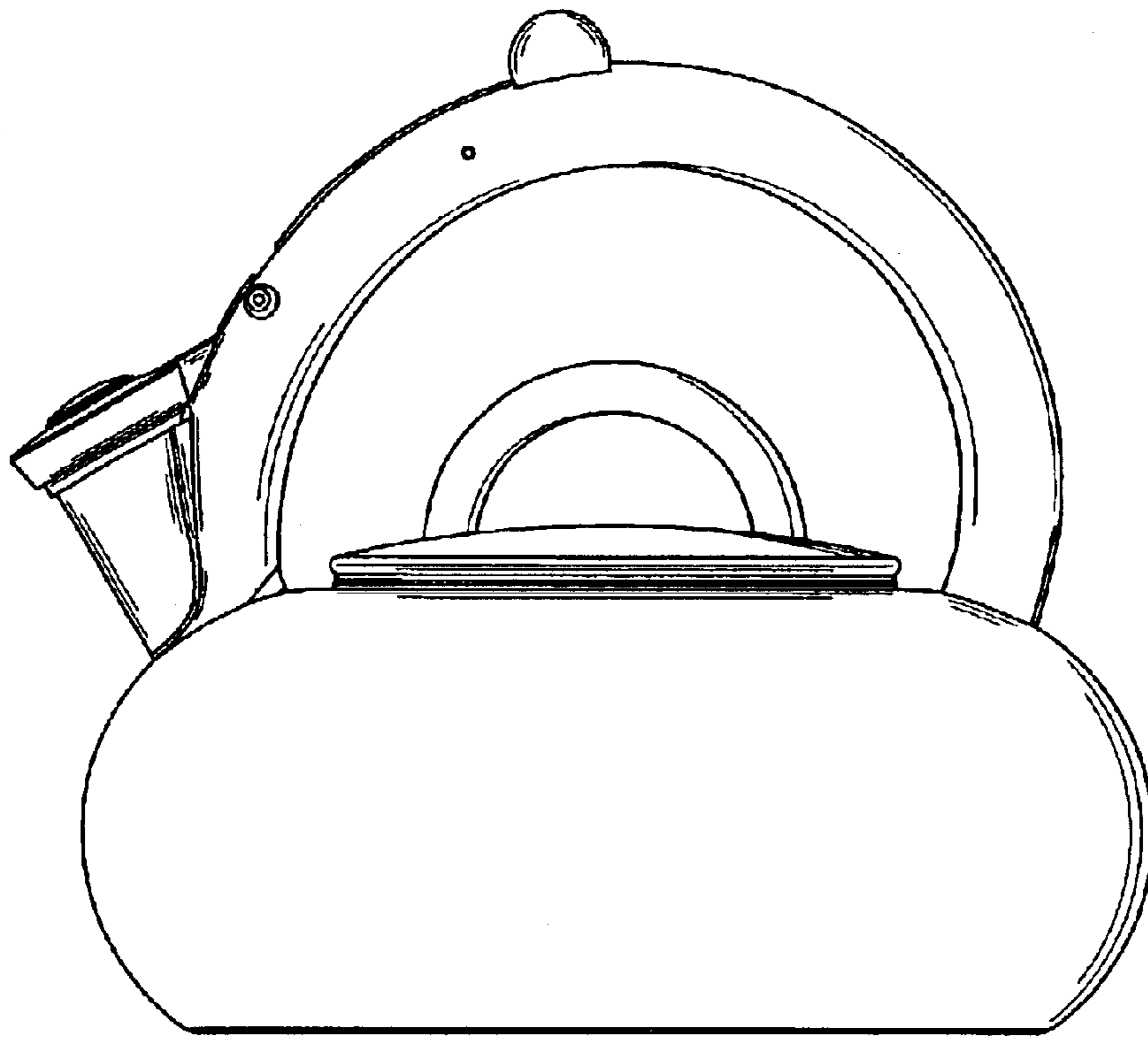

FIG. 4

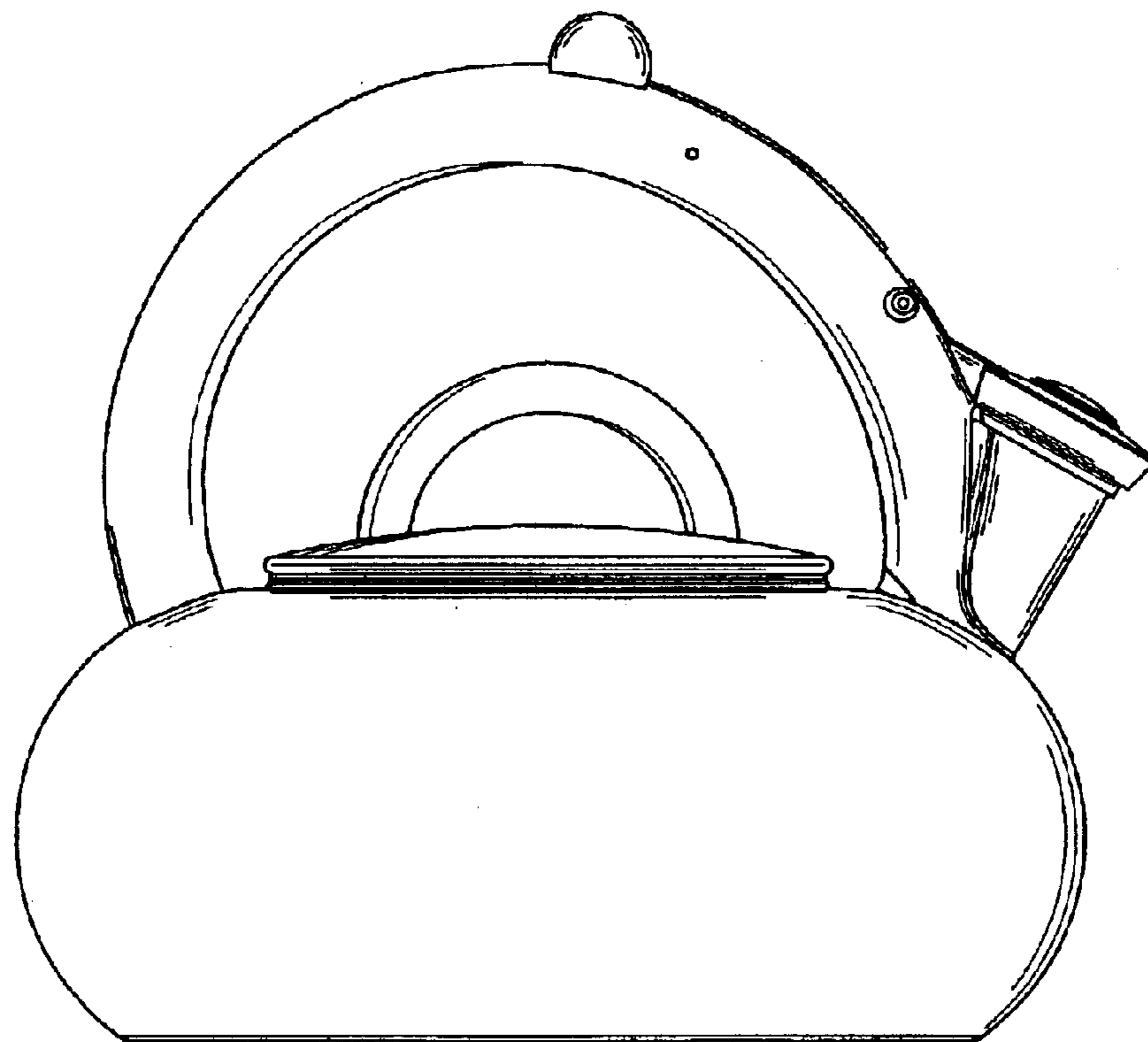

FIG. 5

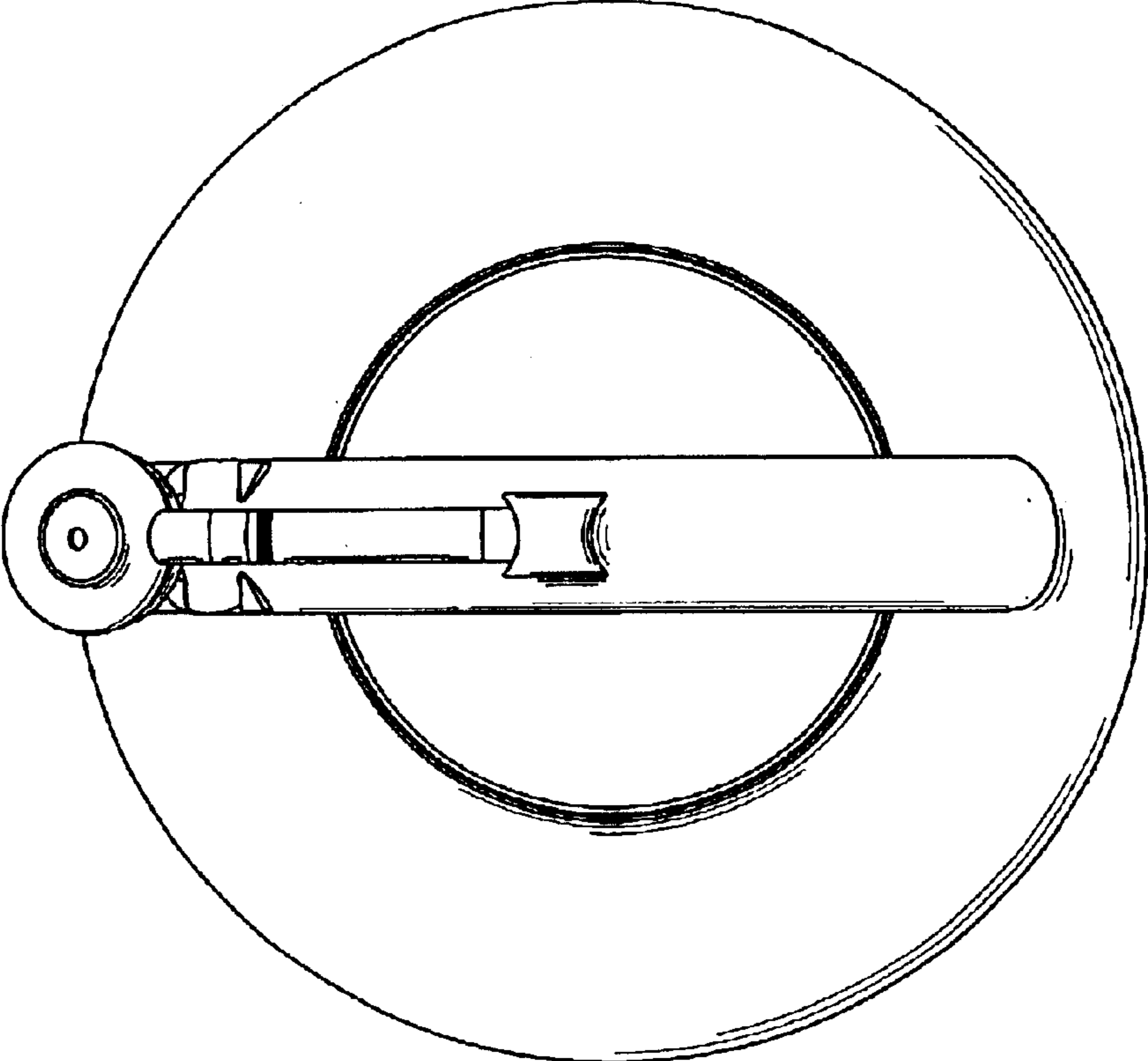

FIG. 6

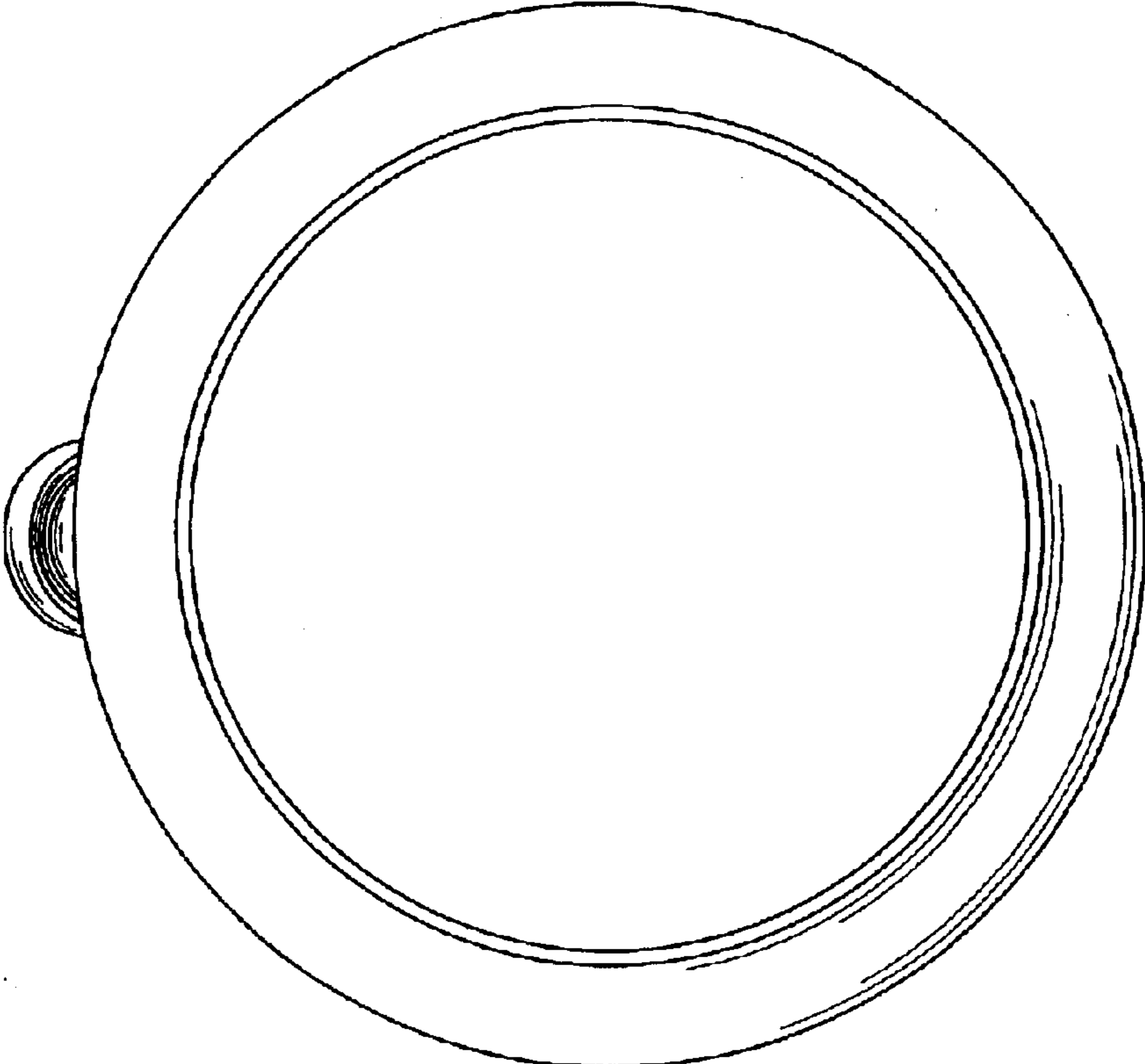

FIG. 7