

US00D497483S1

(12) **United States Design Patent**  
**Bock**

(10) **Patent No.:** **US D497,483 S**  
(45) **Date of Patent:** **\*\* Oct. 26, 2004**

(54) **COMBINED BRUSH AND SCRAPER**

(76) **Inventor:** **Michael G. Bock**, 43045 Tavernsprings Ct., Ashburn, VA (US) 20147

(\*\*) **Term:** **14 Years**

(21) **Appl. No.:** **29/197,407**

(22) **Filed:** **Jan. 15, 2004**

(51) **LOC (7) Cl.** ..... **04-01**

(52) **U.S. Cl.** ..... **D4/118; D32/42**

(58) **Field of Search** ..... D4/118, 132, 134, D4/138; D32/42, 48, 49; 15/105, 111, 143.1, 159.1, 160, 236.01, 236.02, 236.03, 236.05, 236.07; 7/105, 158

(56) **References Cited**

**U.S. PATENT DOCUMENTS**

3,017,649	A	1/1962	Racicot	
D228,585	S	* 10/1973	Spydevold	D4/118
D242,748	S	12/1976	Graham et al.	
D242,882	S	1/1977	Schneider	
4,302,862	A	12/1981	Machacek et al.	
D265,269	S	* 7/1982	Frantz	D4/118
D335,771	S	* 5/1993	Mallory et al.	D4/118
D349,407	S	* 8/1994	White	D4/118

D383,907	S	* 9/1997	Fey et al.	D4/118
5,850,657	A	* 12/1998	List et al.	15/105
D441,198	S	5/2001	Primeau	
D449,739	S	* 10/2001	Gringer	D4/118
6,421,860	B1	7/2002	Abbott	
D461,960	S	8/2002	Bock	
6,481,041	B1	11/2002	Ingram	

\* cited by examiner

*Primary Examiner*—Alan P. Douglas

*Assistant Examiner*—Lavone D. Tabor

(74) *Attorney, Agent, or Firm*—Stephen R. Greiner

(57) **CLAIM**

The ornamental design for a combined brush and scraper, as shown and described.

**DESCRIPTION**

FIG. 1 is a perspective view of a combined brush and scraper showing my new design;

FIG. 2 is a right side elevational view thereof;

FIG. 3 is an enlarged top view thereof;

FIG. 4 is an enlarged bottom view thereof;

FIG. 5 is a left side elevational view thereof;

FIG. 6 is a rear elevational view thereof; and,

FIG. 7 is a front elevational view thereof.

**1 Claim, 2 Drawing Sheets**

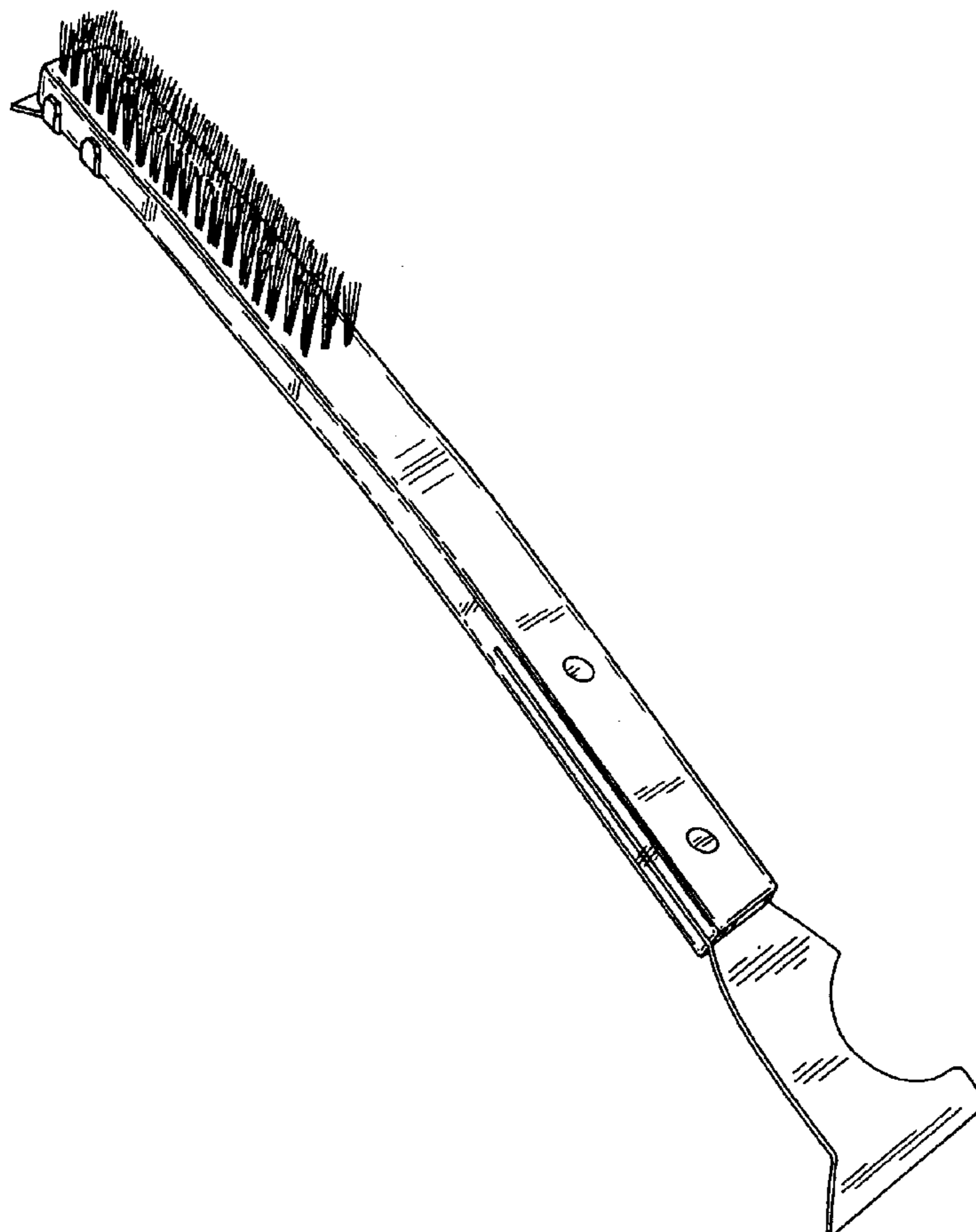

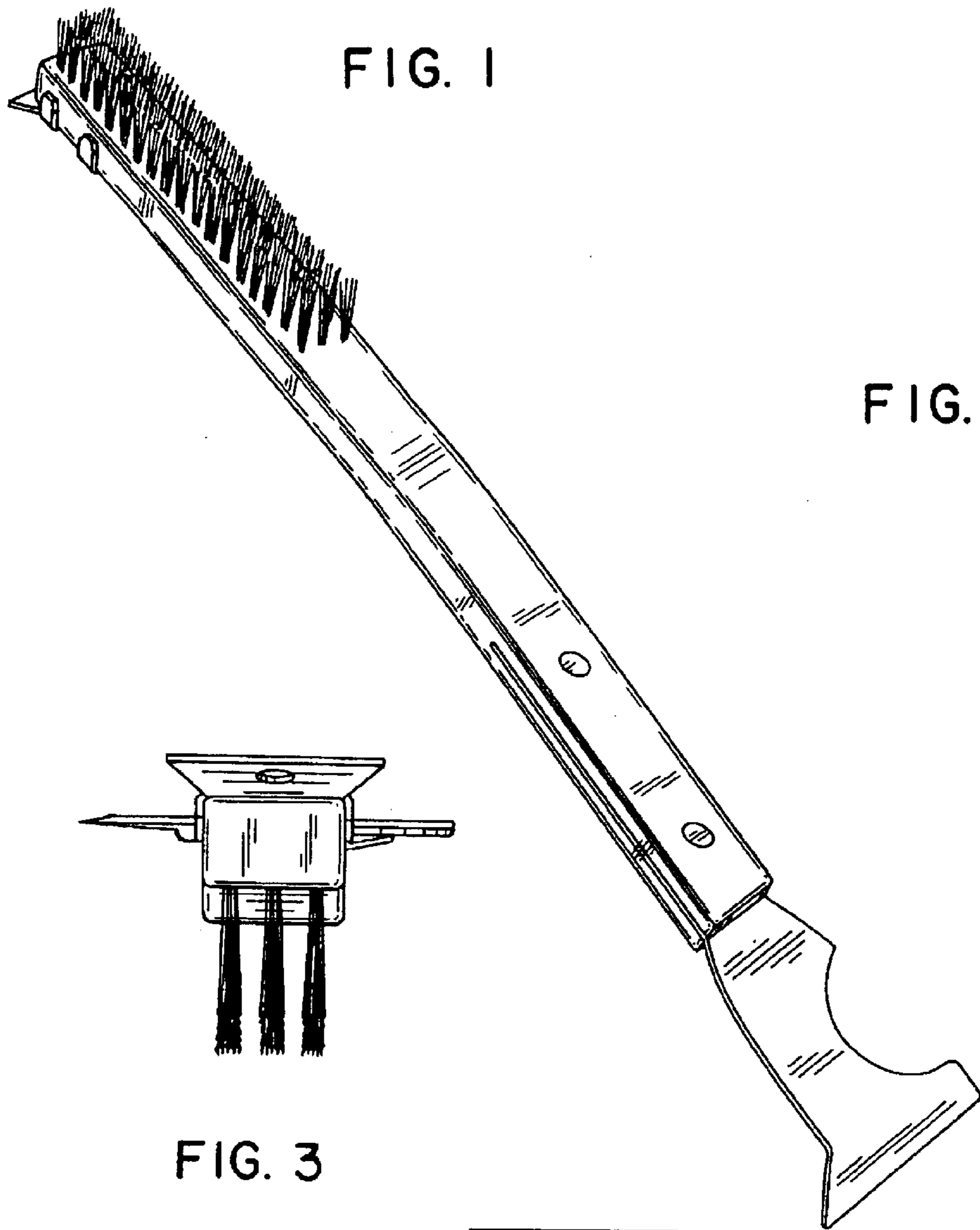

FIG. 1

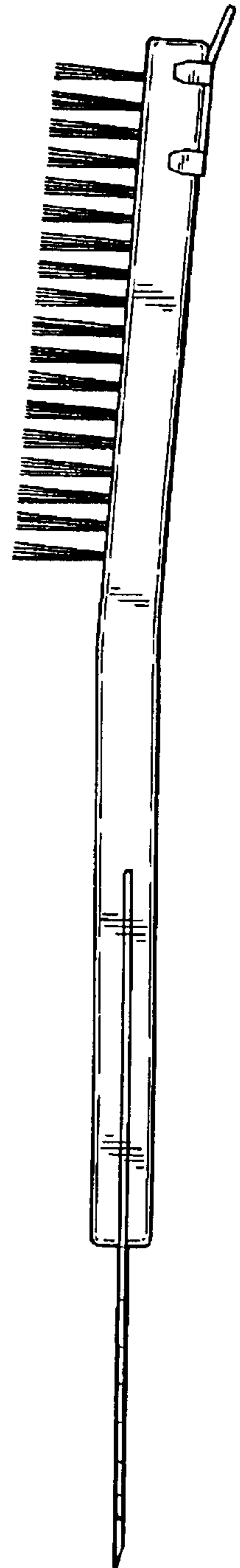

FIG. 2

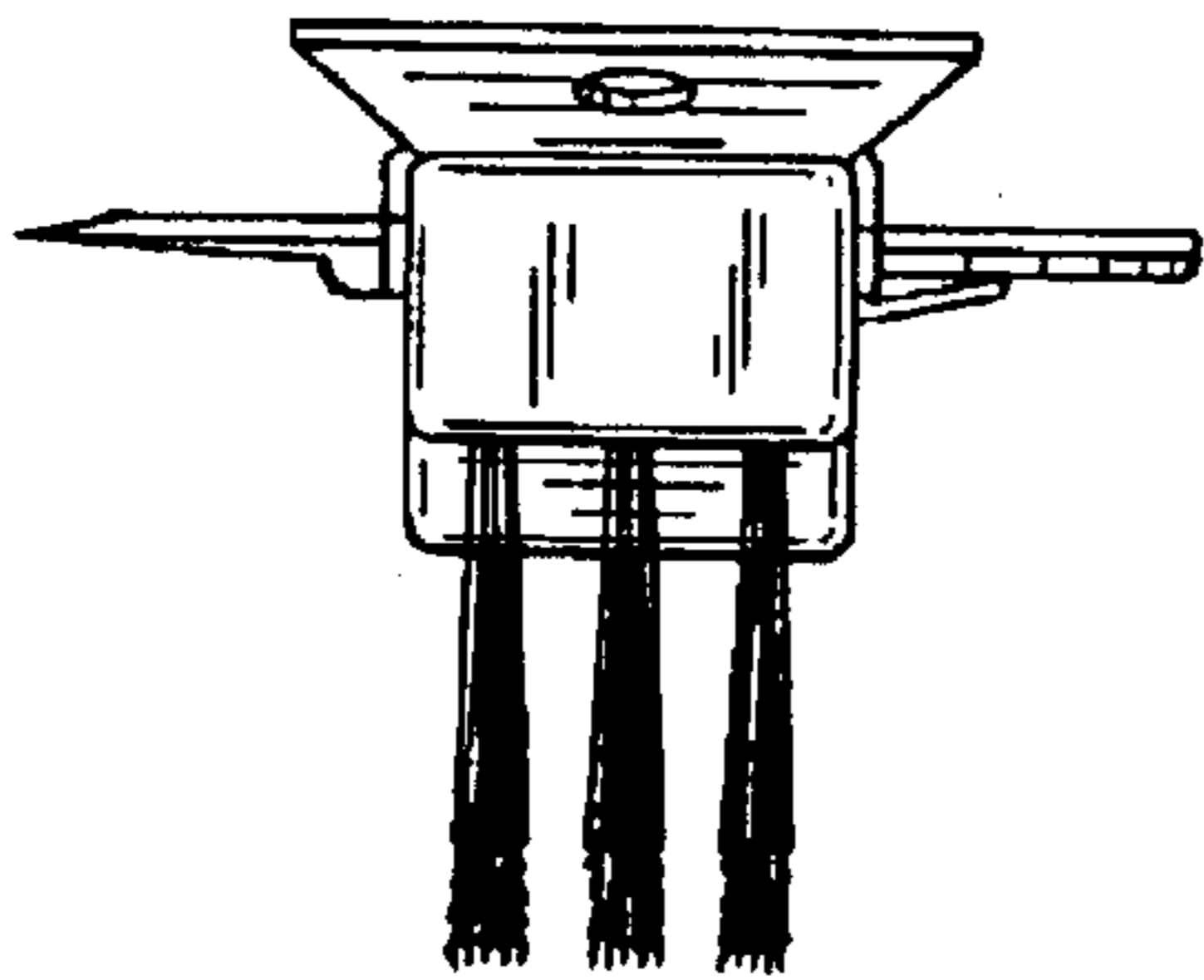

FIG. 3

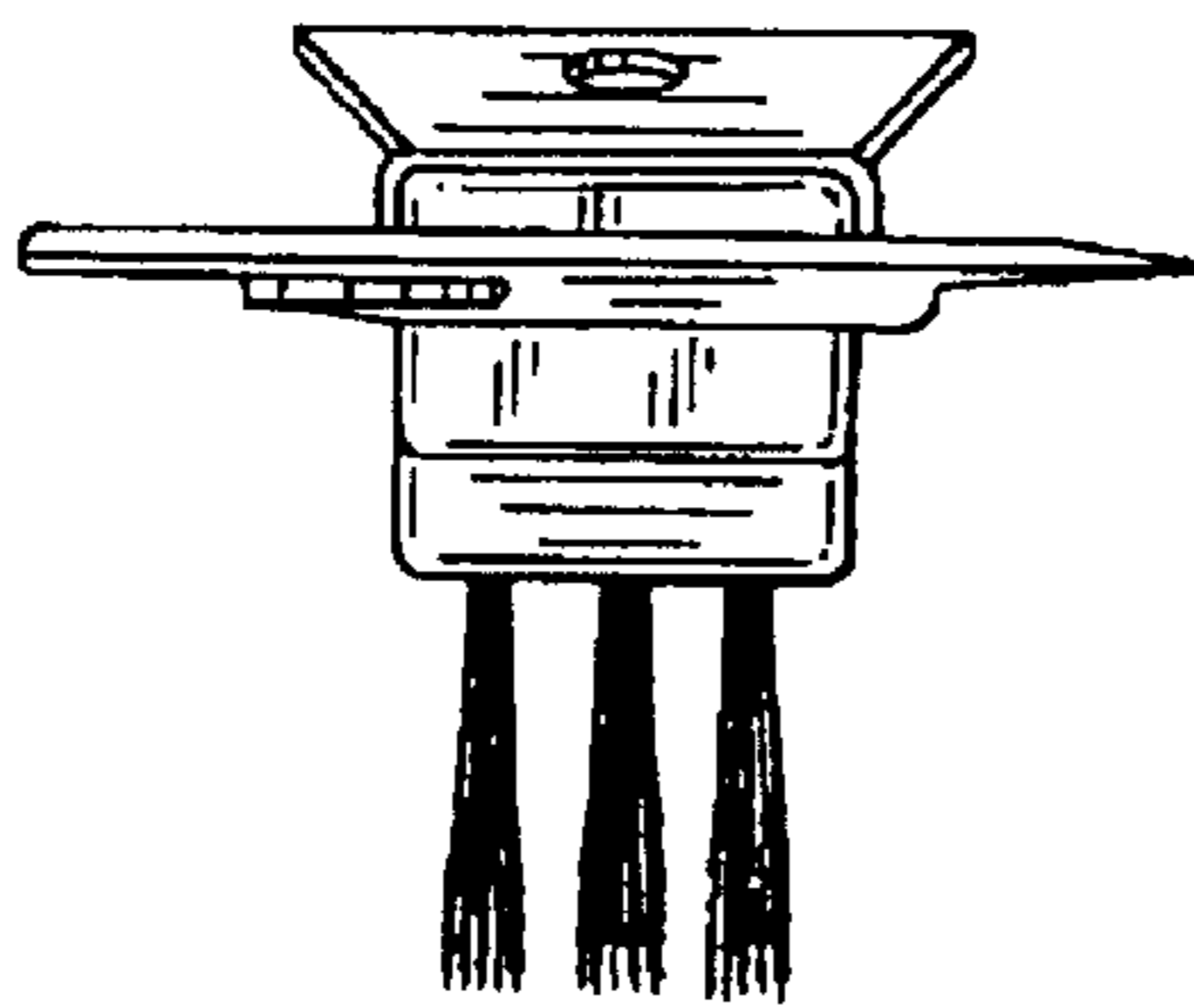

FIG. 4

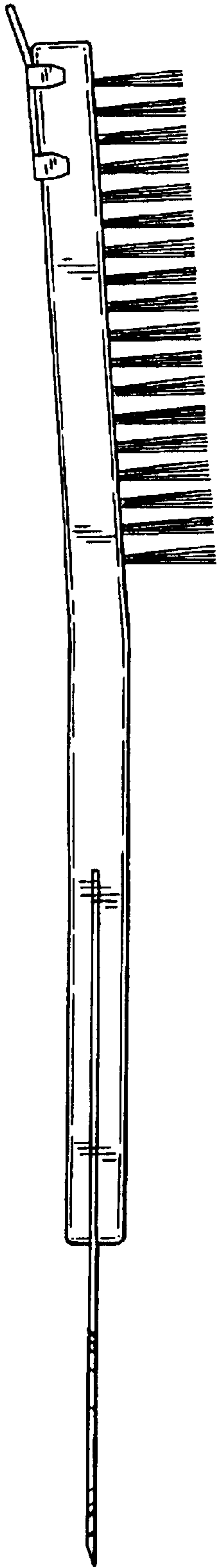

FIG. 5

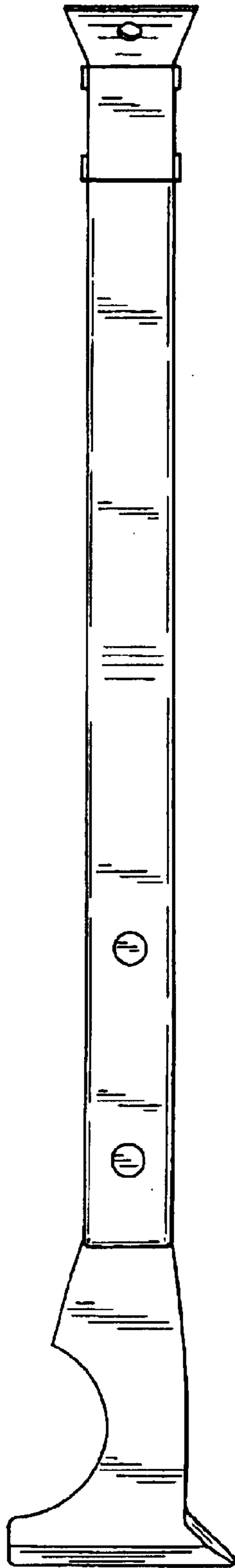

FIG. 6

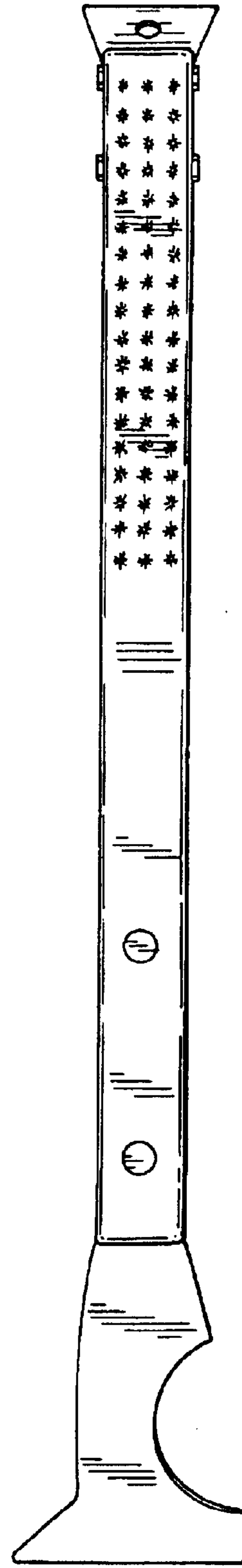

FIG. 7