

US00D497452S1

(12) **United States Design Patent** (10) **Patent No.:** **US D497,452 S**  
**Nielsen et al.** (45) **Date of Patent:** **\*\* Oct. 19, 2004**

(54) **CONSUMER CLIPPER**

(75) Inventors: **Raymond A. Nielsen**, Sterling, IL (US);  
**Scott A. Melton**, Erie, IL (US);  
**Michael Eddinger**, Rock Falls, IL (US)

(73) Assignee: **Wahl Clipper Corporation**, Sterling,  
IL (US)

(\*\*) Term: **14 Years**

(21) Appl. No.: **29/189,666**

(22) Filed: **Sep. 9, 2003**

(51) **LOC (7) Cl.** ..... **28-03**

(52) **U.S. Cl.** ..... **D28/53**

(58) **Field of Search** ..... D28/44, 44.1,  
D28/49-54; 30/34.05, 34.1, 34.2, 41, 41.9,  
43-43.92, 44-45, 210, 223

(56) **References Cited**

**U.S. PATENT DOCUMENTS**

5,787,587 A	8/1998	Wahl et al.	
D436,692 S	1/2001	Larsen	
D445,541 S	* 7/2001	Wursthorn	..... D28/53
D454,980 S	3/2002	Long et al.	
D455,230 S	* 4/2002	Lau	..... D28/53
2003/0051347 A1	* 3/2003	Melton et al.	..... 30/34.1

\* cited by examiner

*Primary Examiner*—Jennifer Rivard

(74) *Attorney, Agent, or Firm*—Greer, Burns & Crain, Ltd.

(57) **CLAIM**

The ornamental design for a consumer clipper, as shown and described.

**DESCRIPTION**

FIG. 1 is a front perspective view of a first embodiment of the present design for a consumer clipper;

FIG. 2 is a top view of same;

FIG. 3 is a right side view of same;

FIG. 4 is a bottom view of the present clipper;

FIG. 5 is left side view of same;

FIG. 6 is a front view of same; and

FIG. 7 is a rear view of the clipper of FIG. 1.

FIG. 8 is a front perspective view of a second embodiment of the present consumer clipper;

FIG. 9 is a top view of same;

FIG. 10 is a right side view of same;

FIG. 11 is a bottom view of the consumer clipper of FIG. 8;

FIG. 12 is a left side view of same;

FIG. 13 is a front view of same; and

FIG. 14 is a rear view of the consumer clipper of FIG. 8.

FIG. 15 is a front perspective view of a third embodiment of the present consumer clipper;

FIG. 16 is a top view of same;

FIG. 17 is a right side view of same;

FIG. 18 is a bottom view of the consumer clipper of FIG. 15;

FIG. 19 is a left side view of same;

FIG. 20 is front view of same; and,

FIG. 21 is a rear view of the consumer clipper of FIG. 15.

It should be noted that the broken lines in the drawings are for purposes of explanation only and form no part of the claimed invention.

**1 Claim, 6 Drawing Sheets**

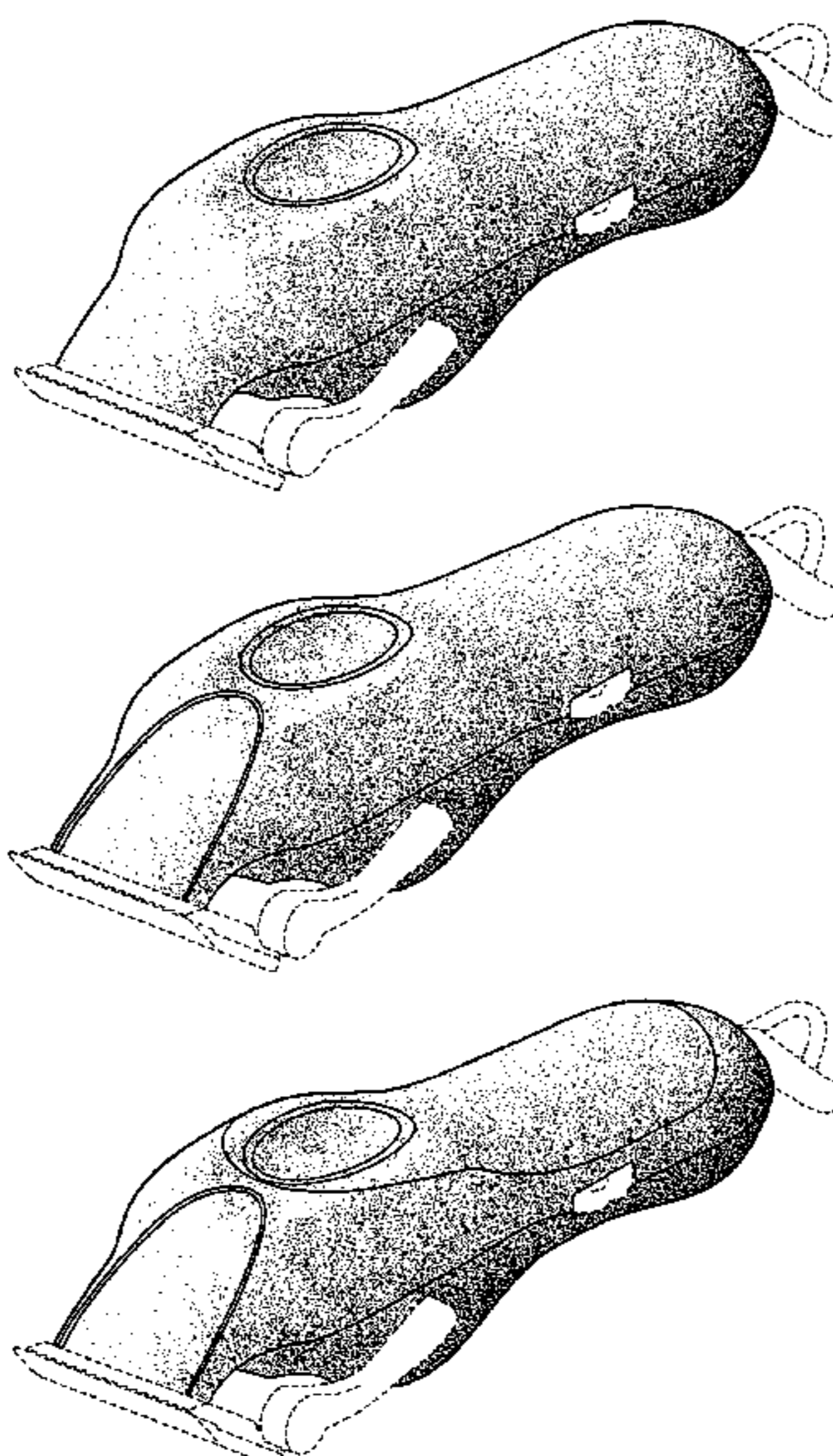

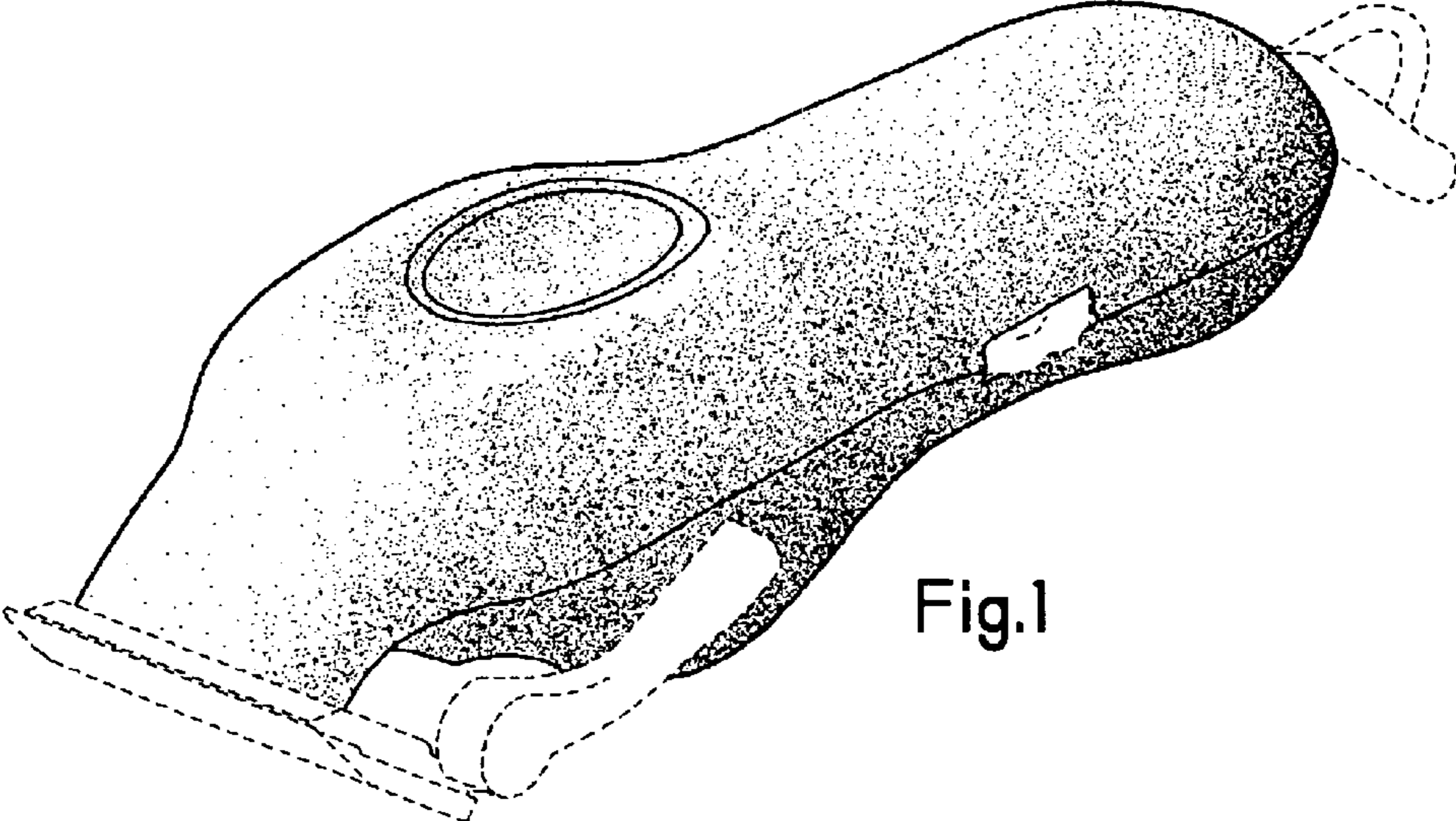

Fig.1

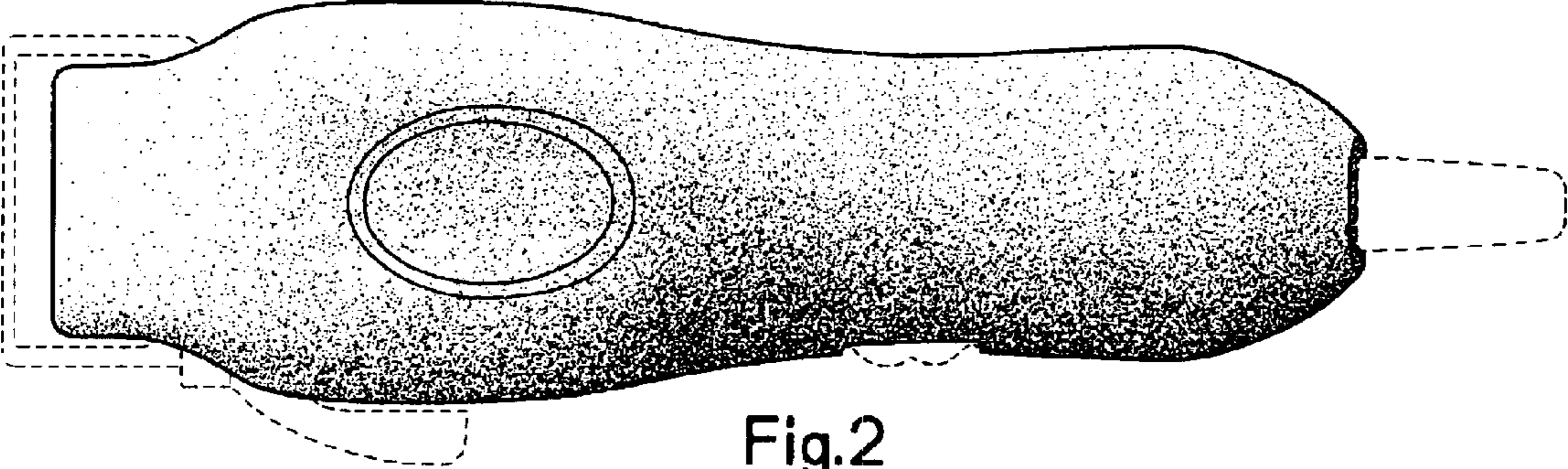

Fig.2

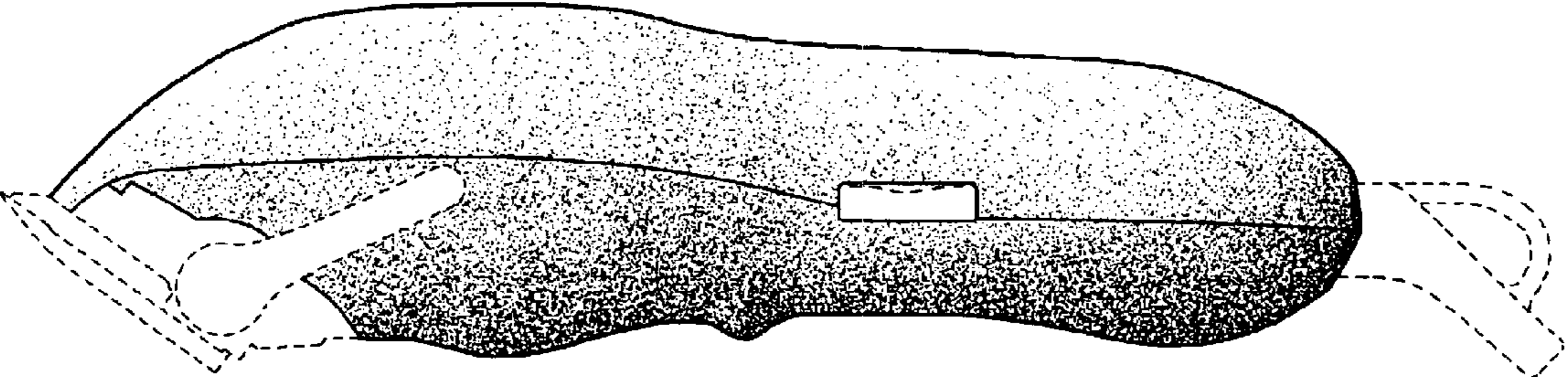

Fig.3

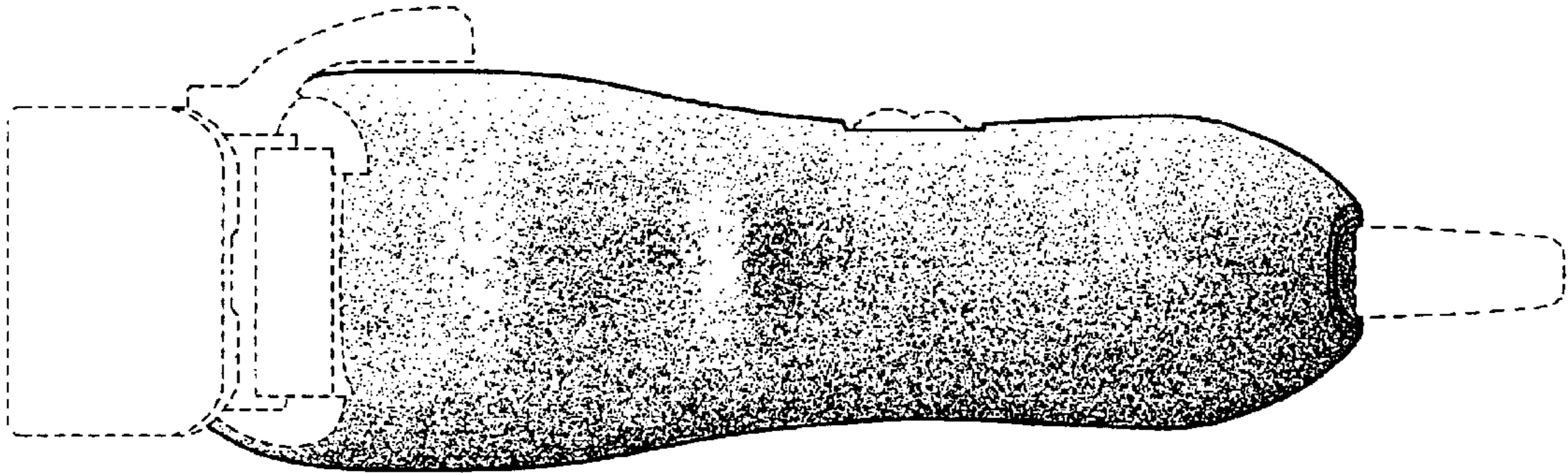

Fig. 4

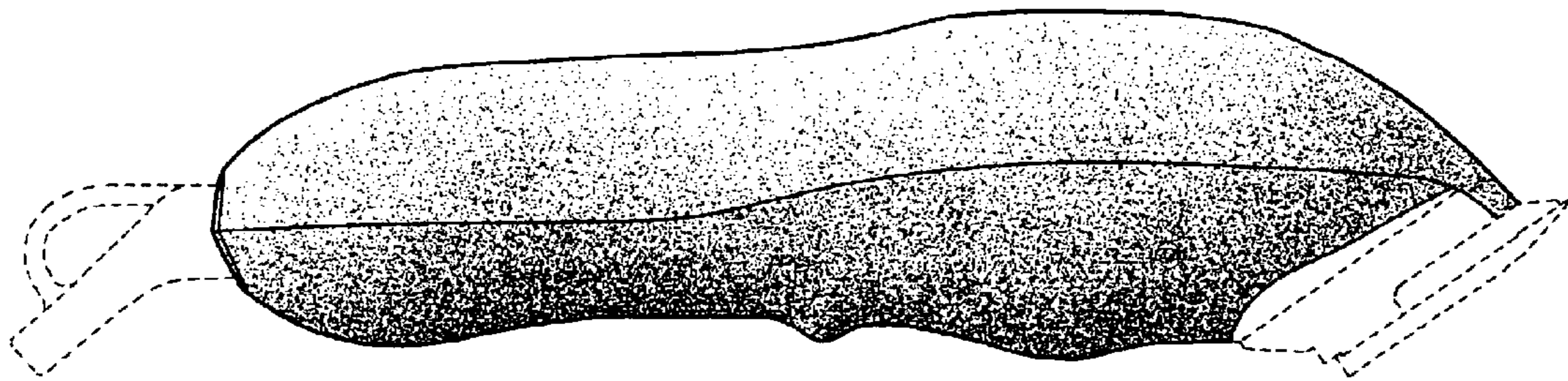

Fig. 5

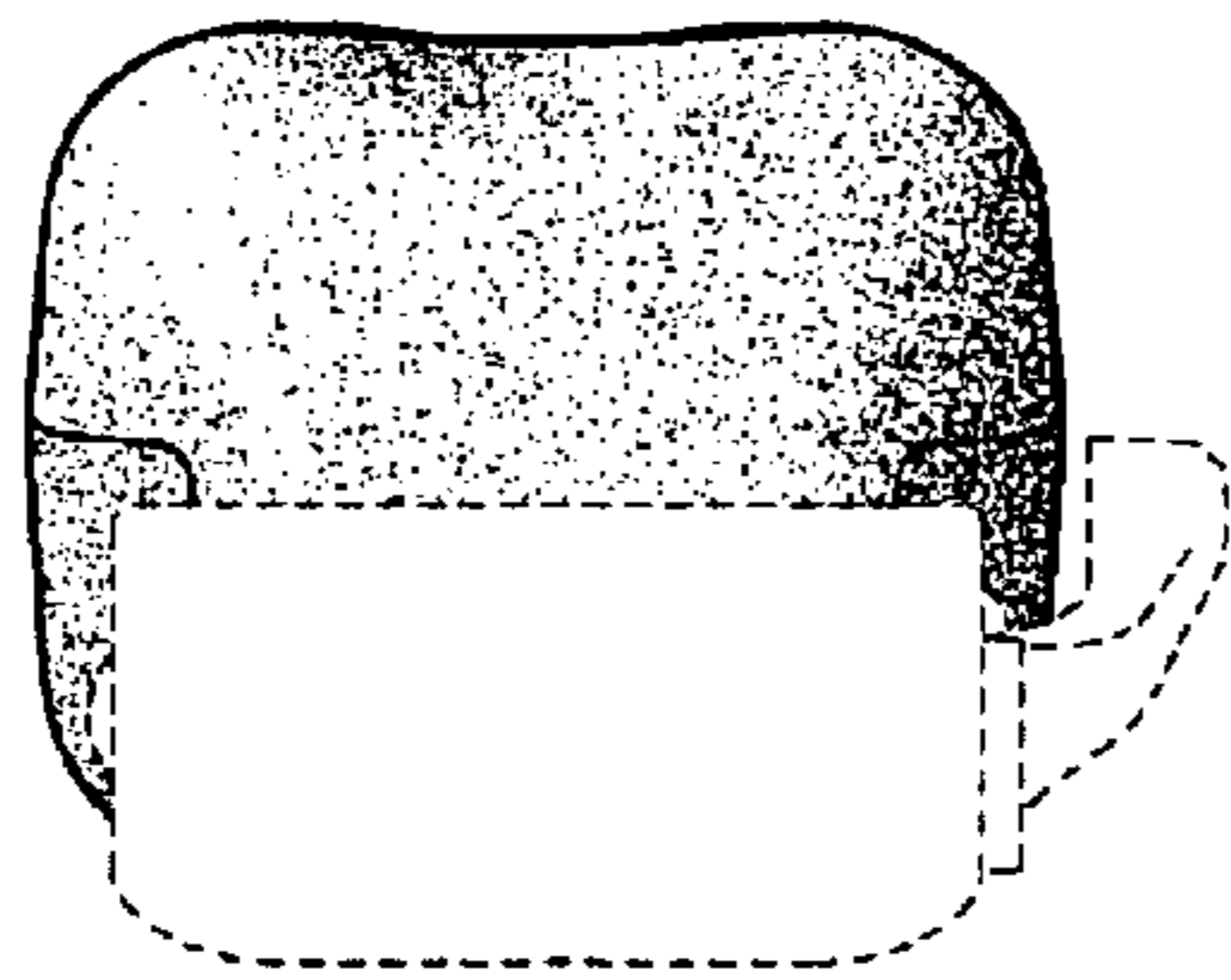

Fig. 6

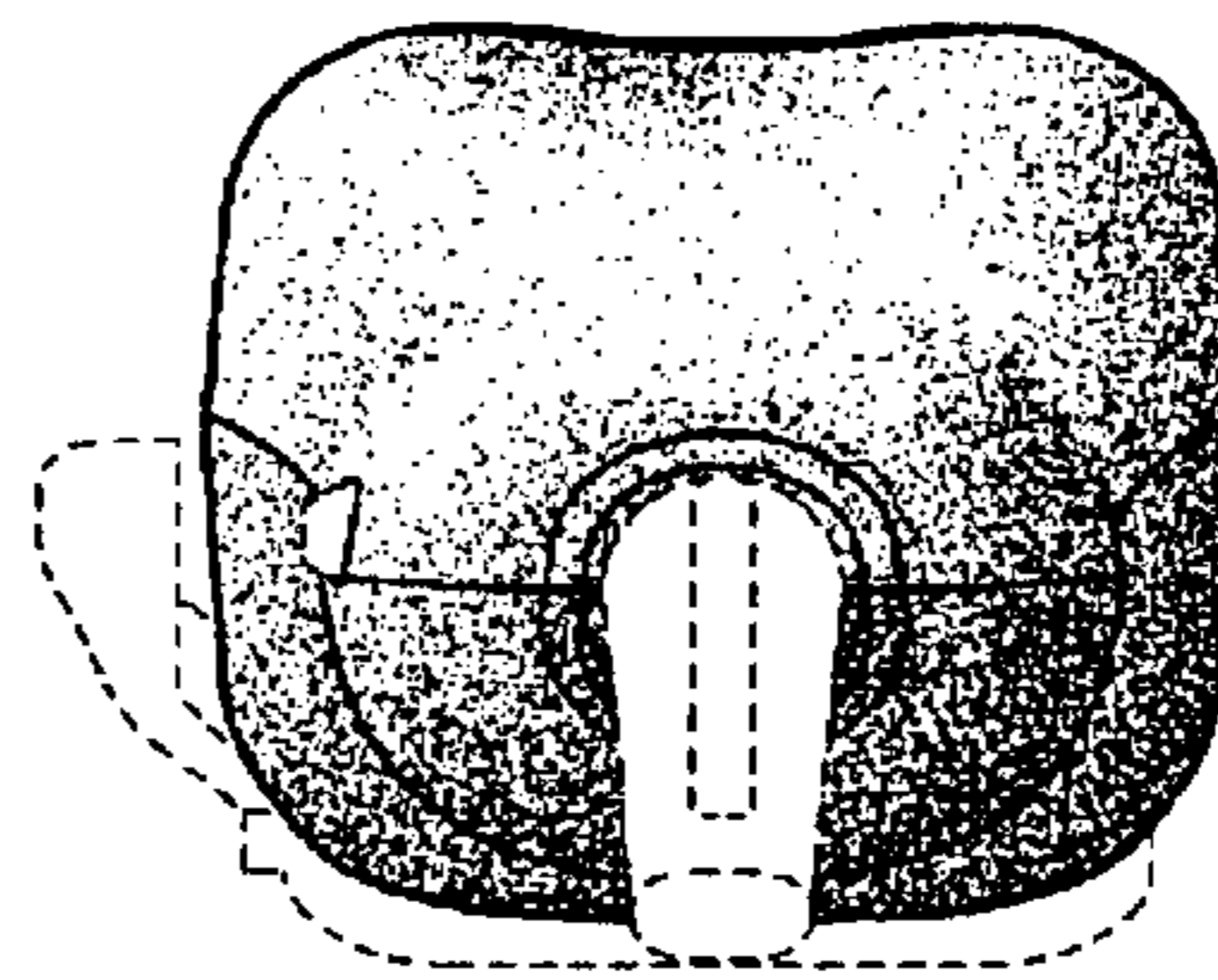

Fig. 7

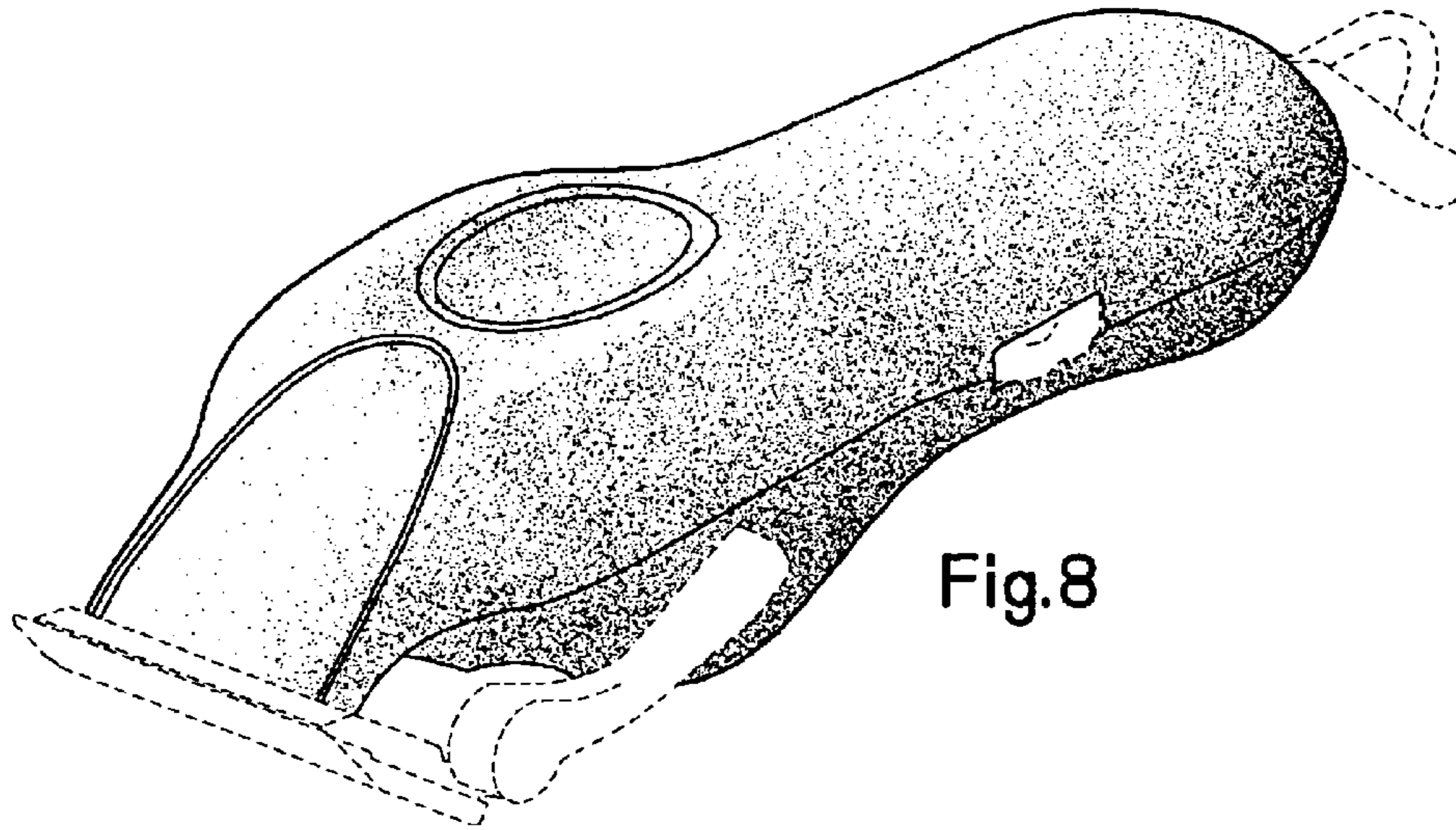

Fig.8

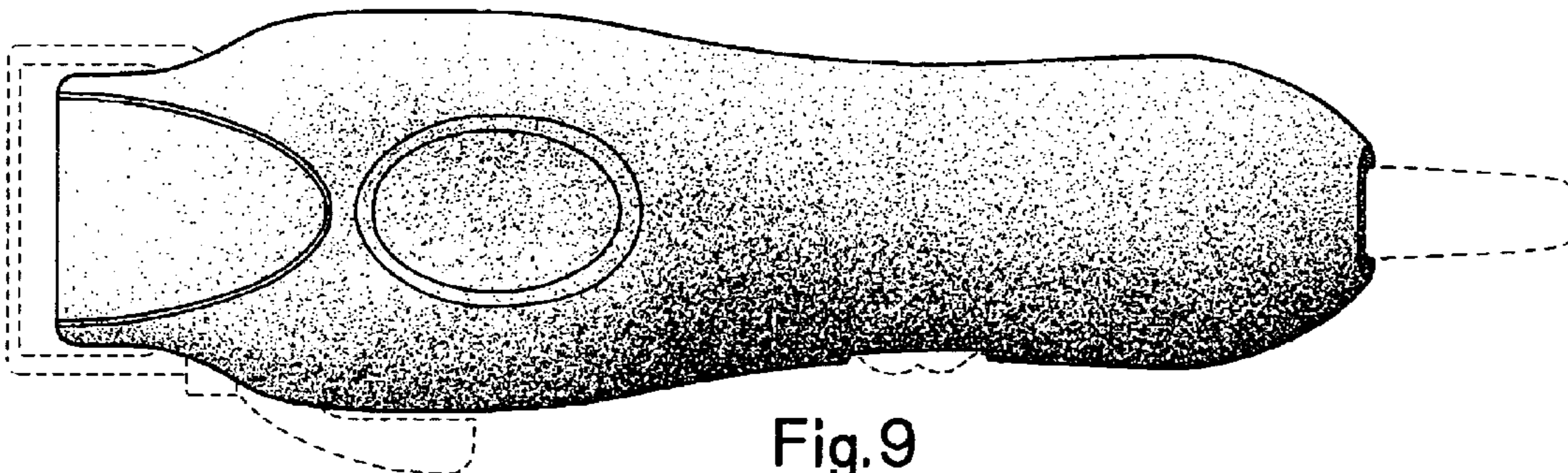

Fig.9

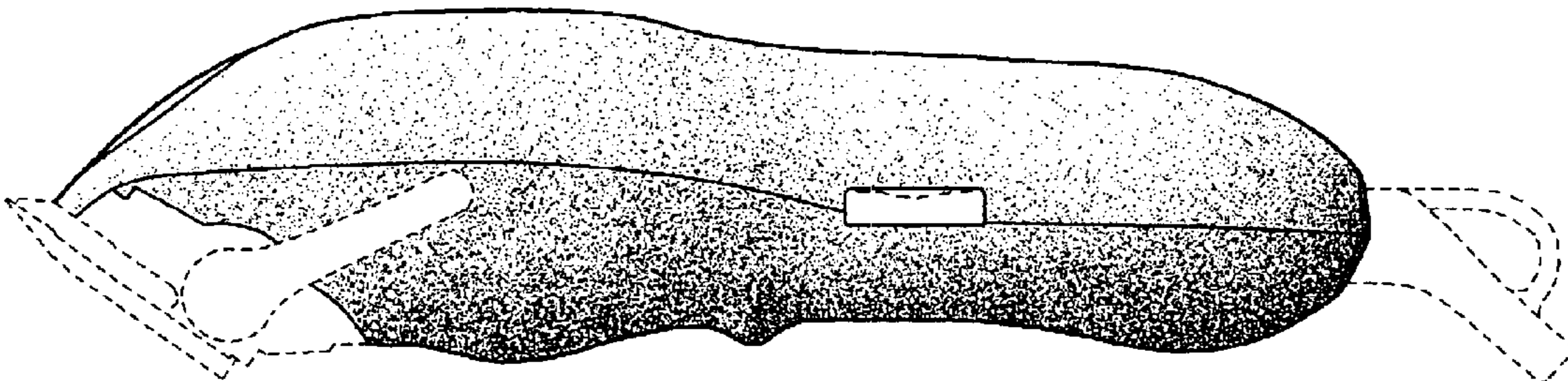

Fig.10



Fig.11

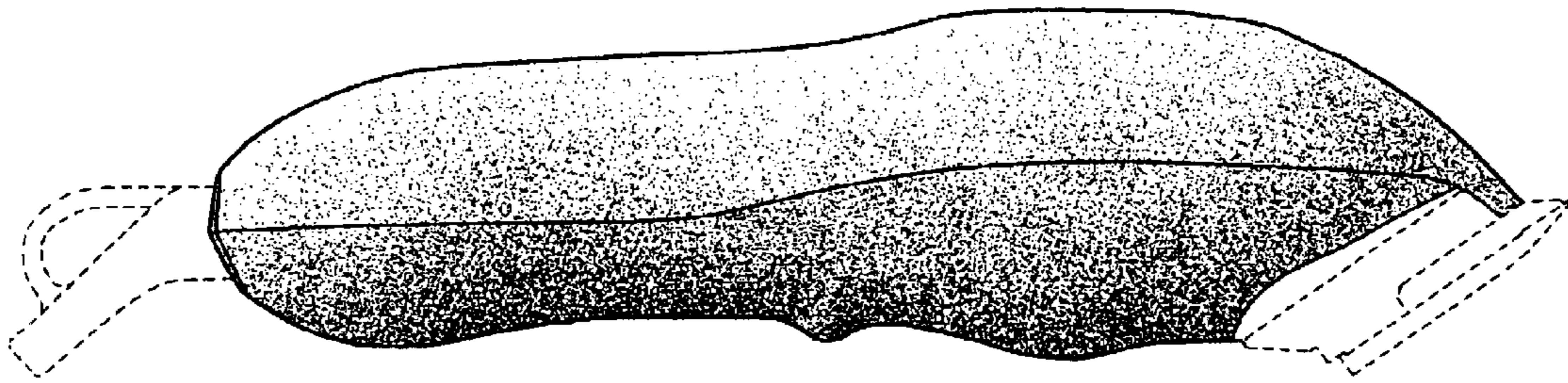

Fig.12

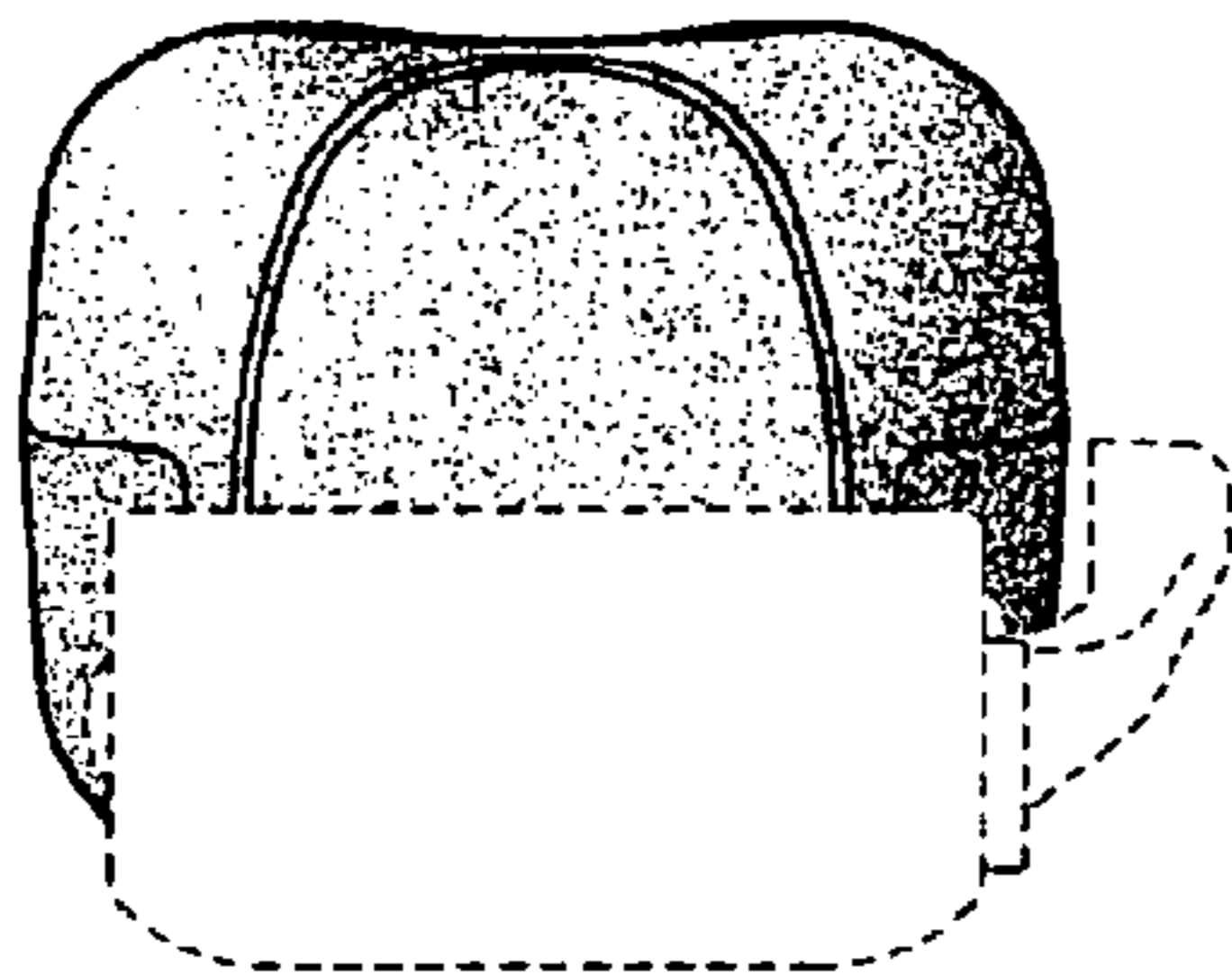

Fig.13

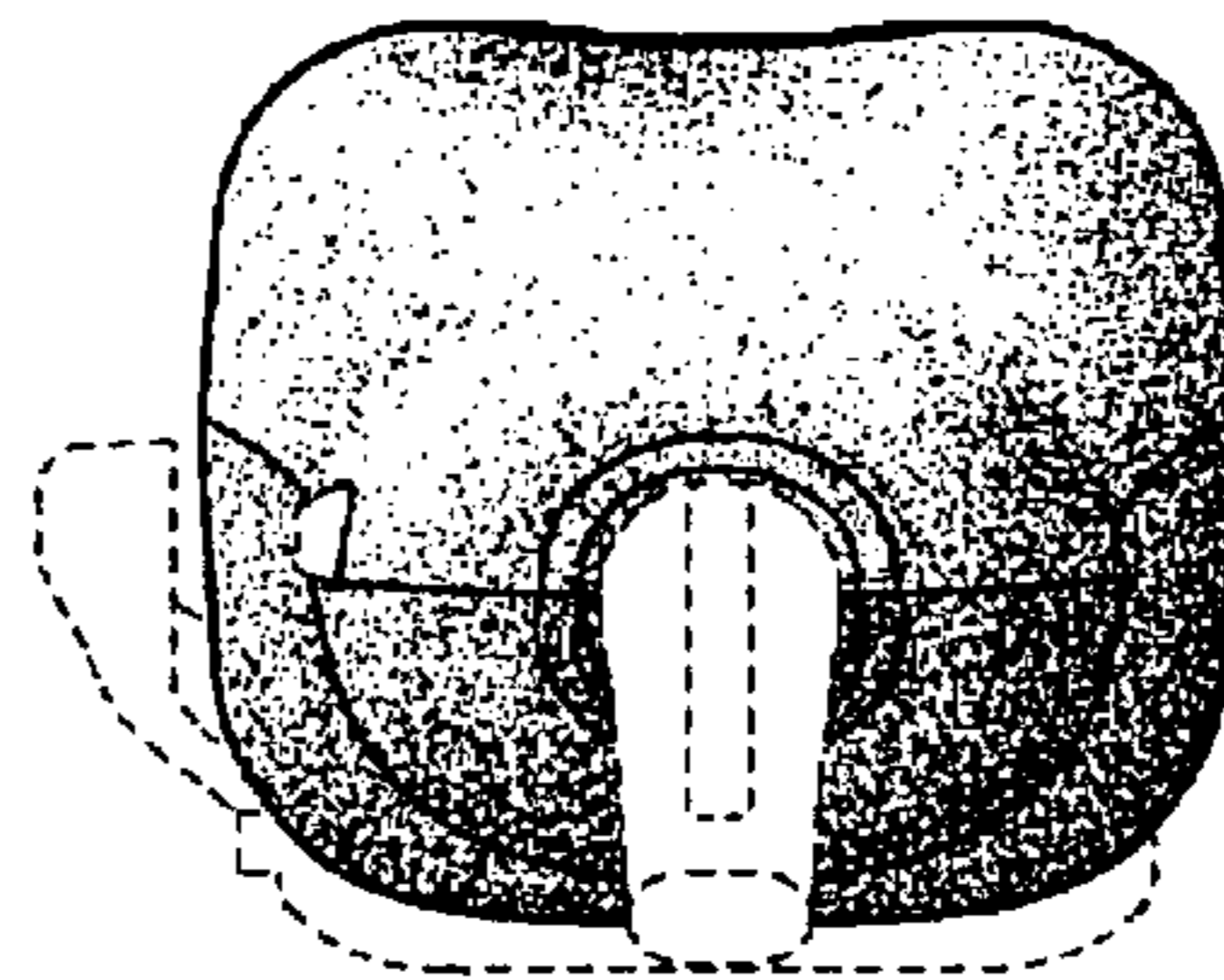

Fig.14

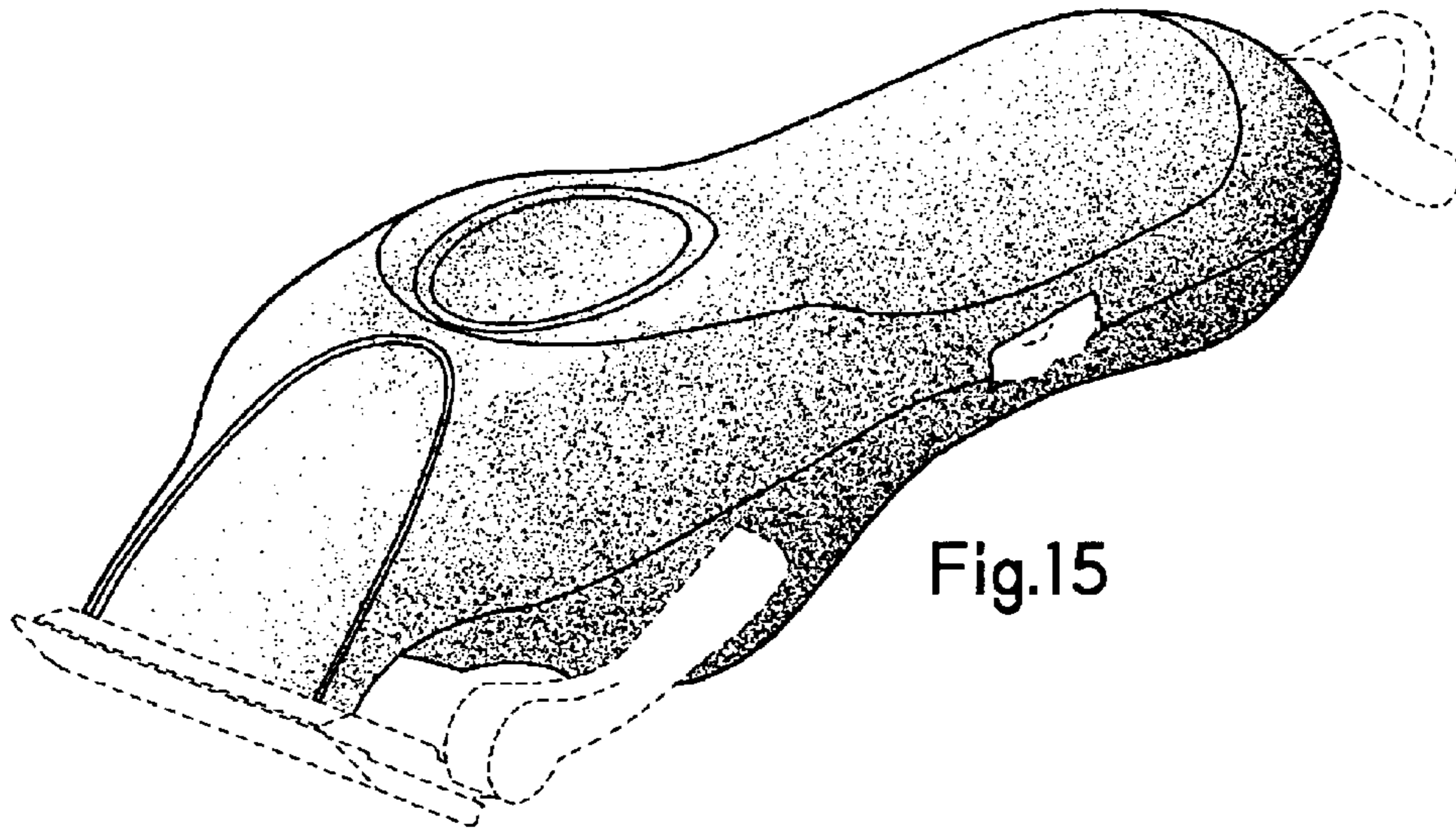

Fig.15

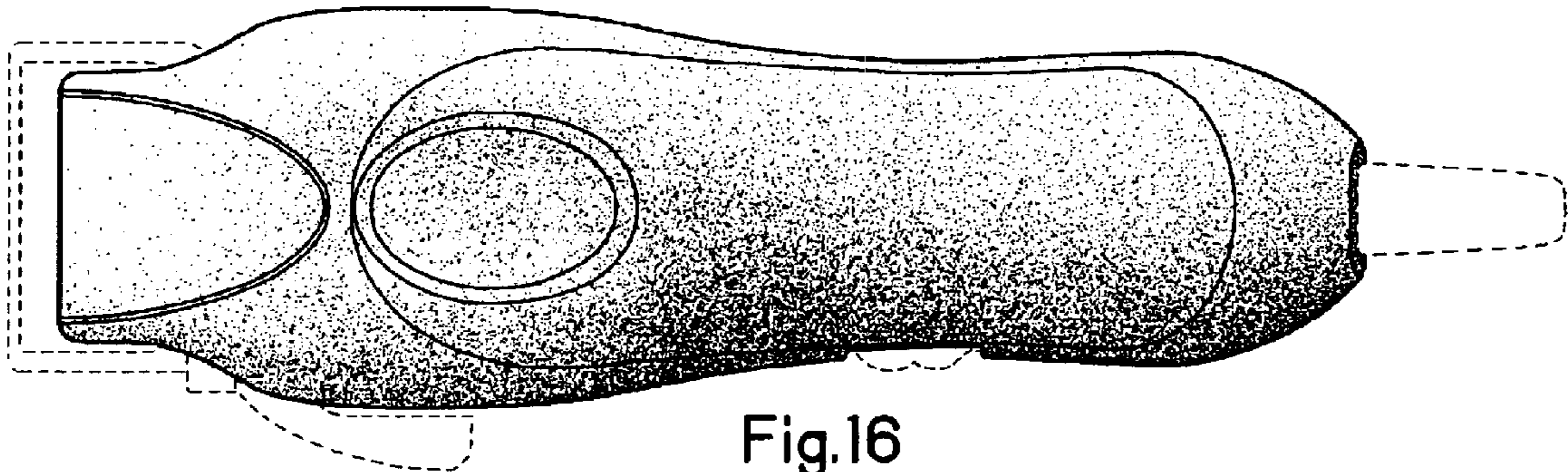

Fig.16

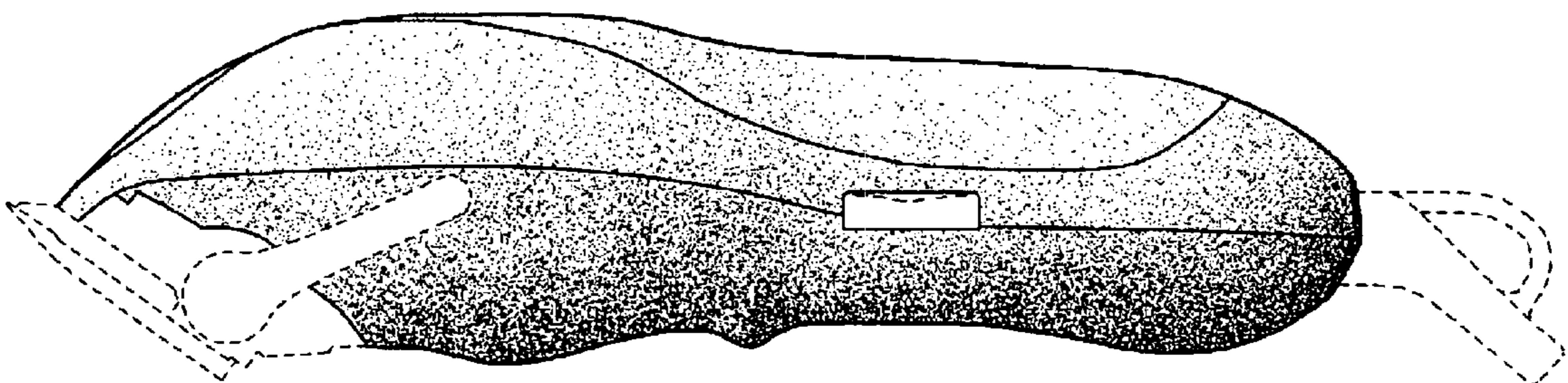

Fig.17

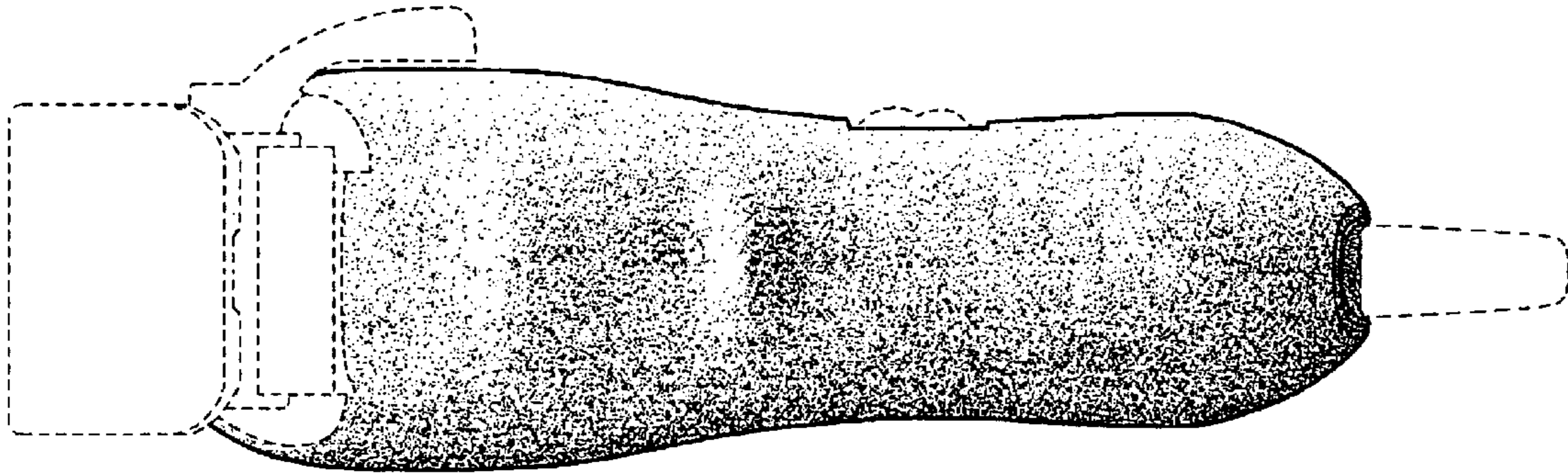

Fig.18

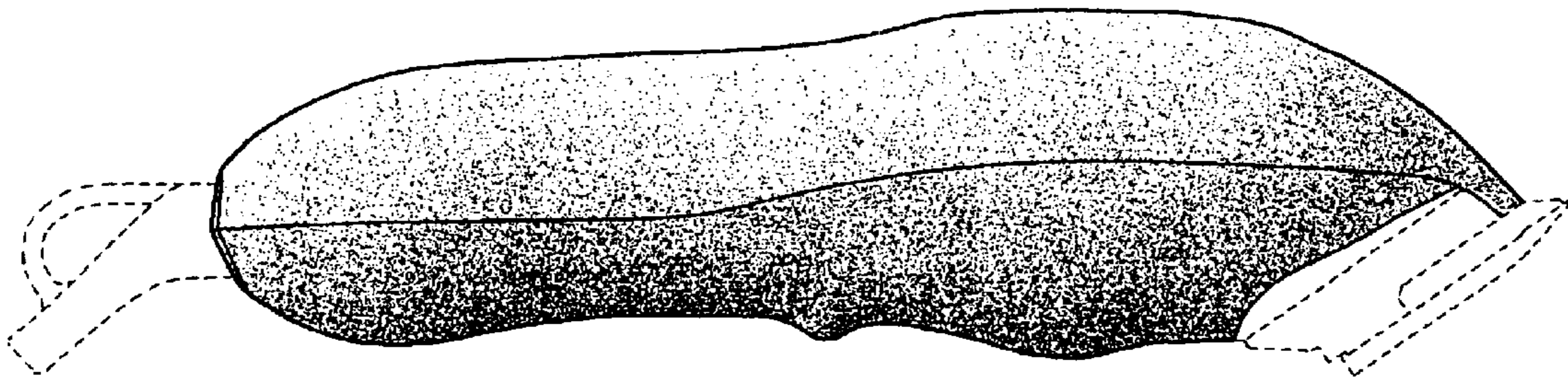

Fig.19

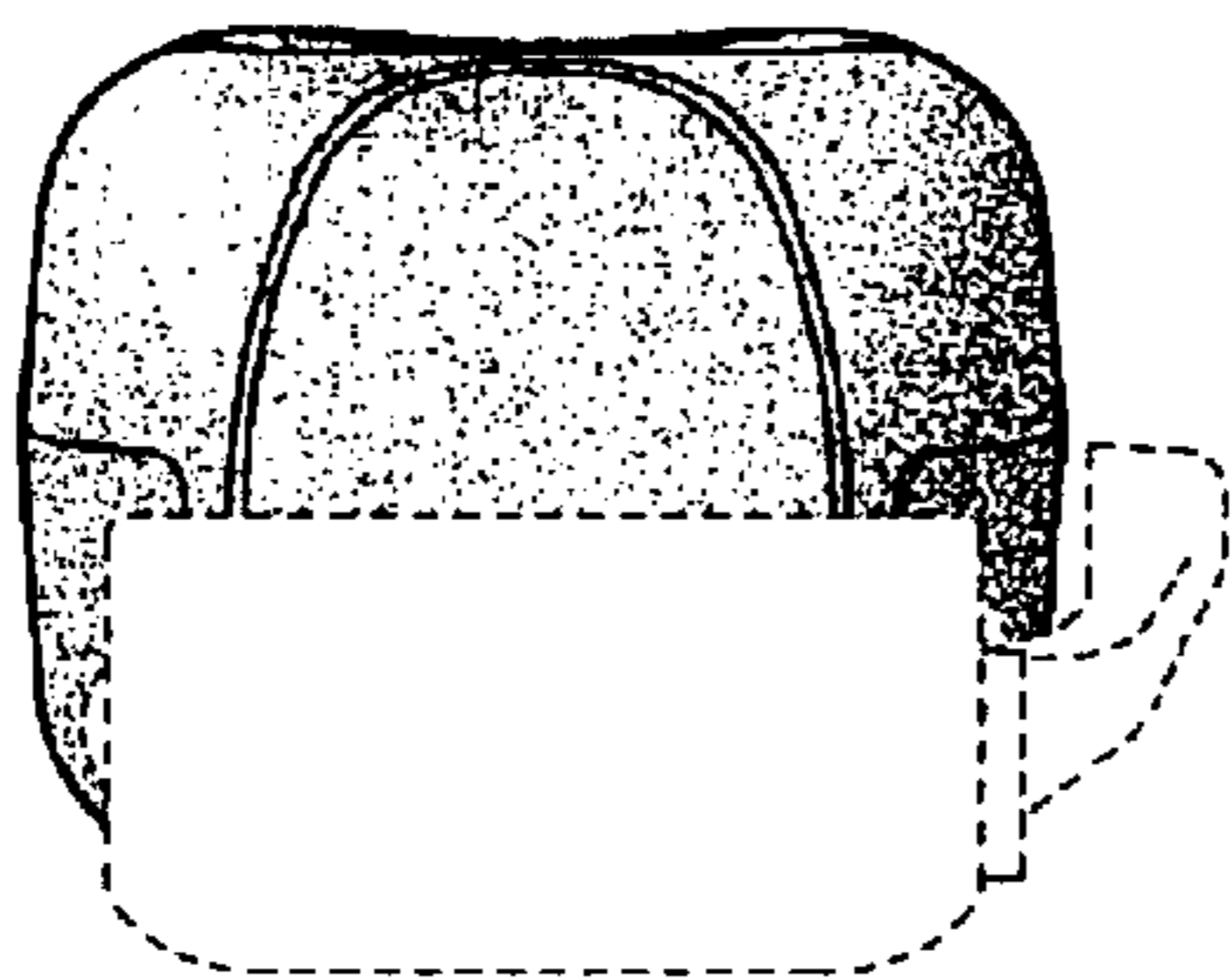

Fig.20

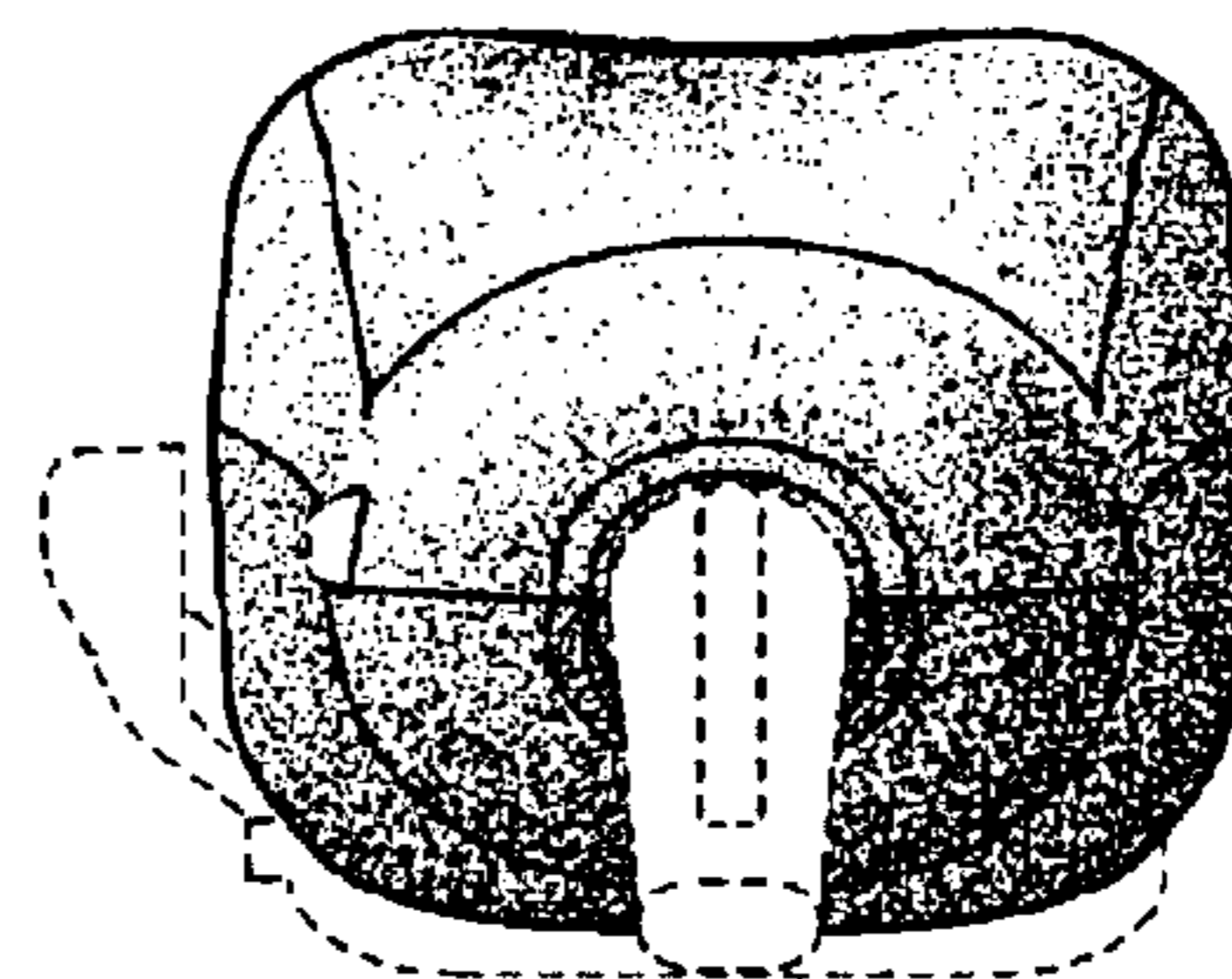

Fig.21