

US00D497331S1

(12) **United States Design Patent**
Chiu

(10) **Patent No.:** **US D497,331 S**
(45) **Date of Patent:** **** Oct. 19, 2004**

(54) **CHILDREN TRICYCLE**

(76) **Inventor:** **I-Cheng Chiu**, 9F, No. 70, Sec. 5,
Nan-King East Rd., Taipei (TW)

(**) **Term:** **14 Years**

(21) **Appl. No.:** **29/198,190**

(22) **Filed:** **Jan. 28, 2004**

(51) **LOC (7) Cl.** **12-11**

(52) **U.S. Cl.** **D12/112**

(58) **Field of Search** **D12/109, 112;**
280/202, 203, 209, 222, 231, 273, 282

(56) **References Cited**

U.S. PATENT DOCUMENTS

D266,556 S * 10/1982 Arthur D12/112

D289,271 S * 4/1987 Hendrickson et al. D12/112

* cited by examiner

Primary Examiner—Alan P. Douglas

Assistant Examiner—Linda Brooks

(74) *Attorney, Agent, or Firm*—Bacon & Thomas PLLC

(57) **CLAIM**

The ornamental design for a children tricycle, as shown and described.

DESCRIPTION

FIG. 1 is a perspective view of a children tricycle showing my new design;

FIG. 2 is a front elevational view thereof;

FIG. 3 is a rear elevational view thereof;

FIG. 4 is a top plan view thereof;

FIG. 5 is a bottom plan view thereof;

FIG. 6 is a left side elevational view thereof; and,

FIG. 7 is a right side elevational view thereof.

1 Claim, 4 Drawing Sheets

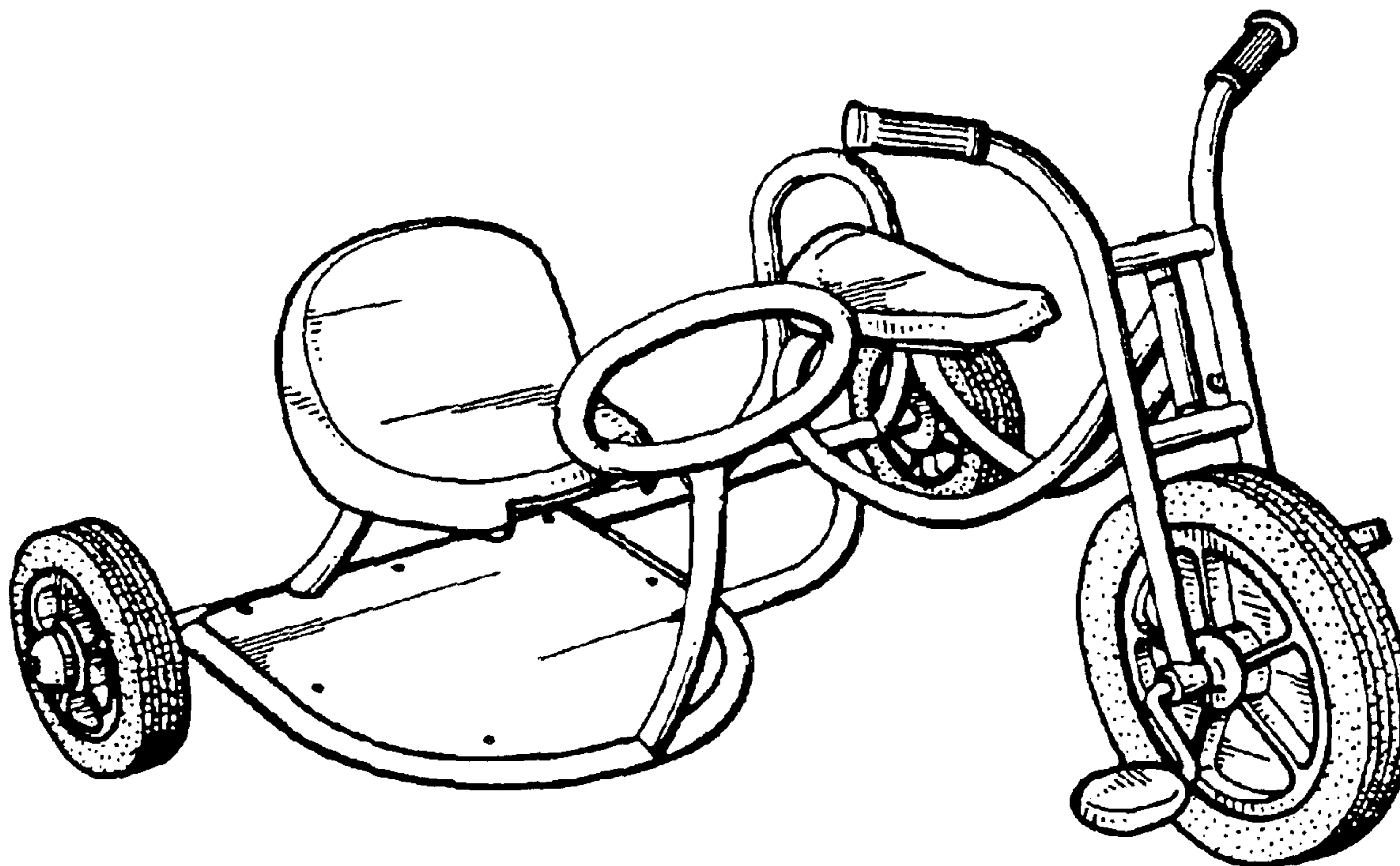

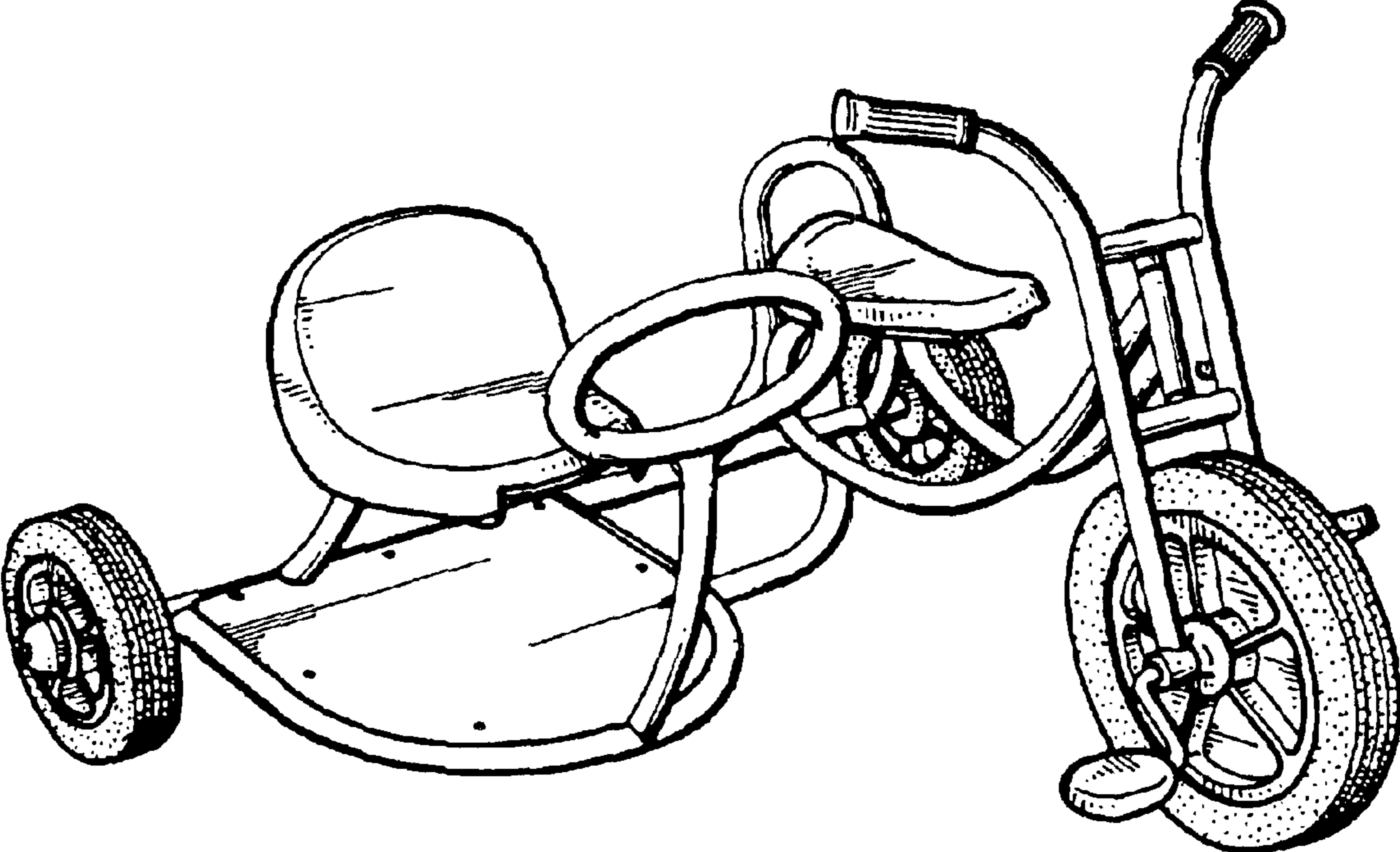

FIG. 1

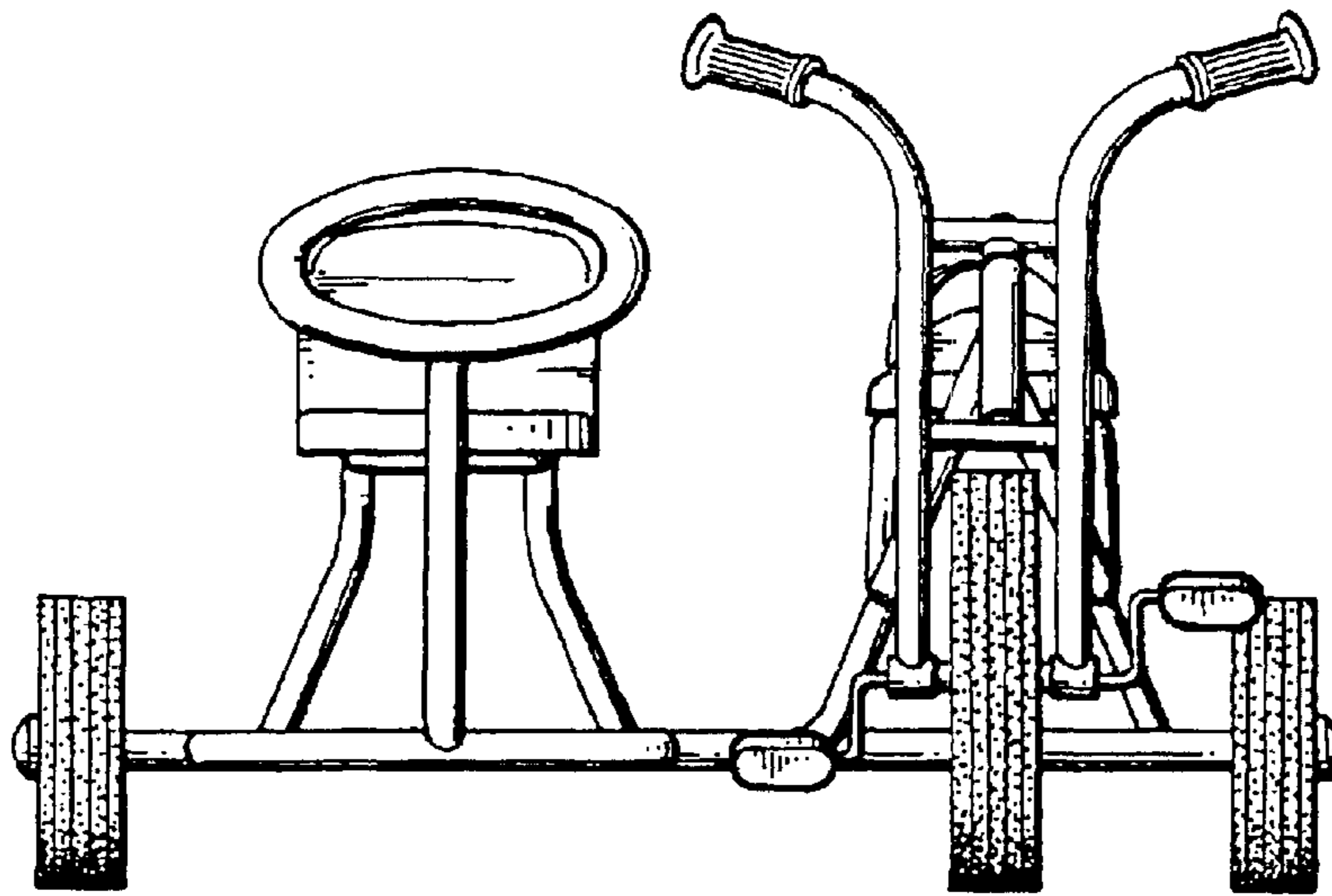

FIG. 2

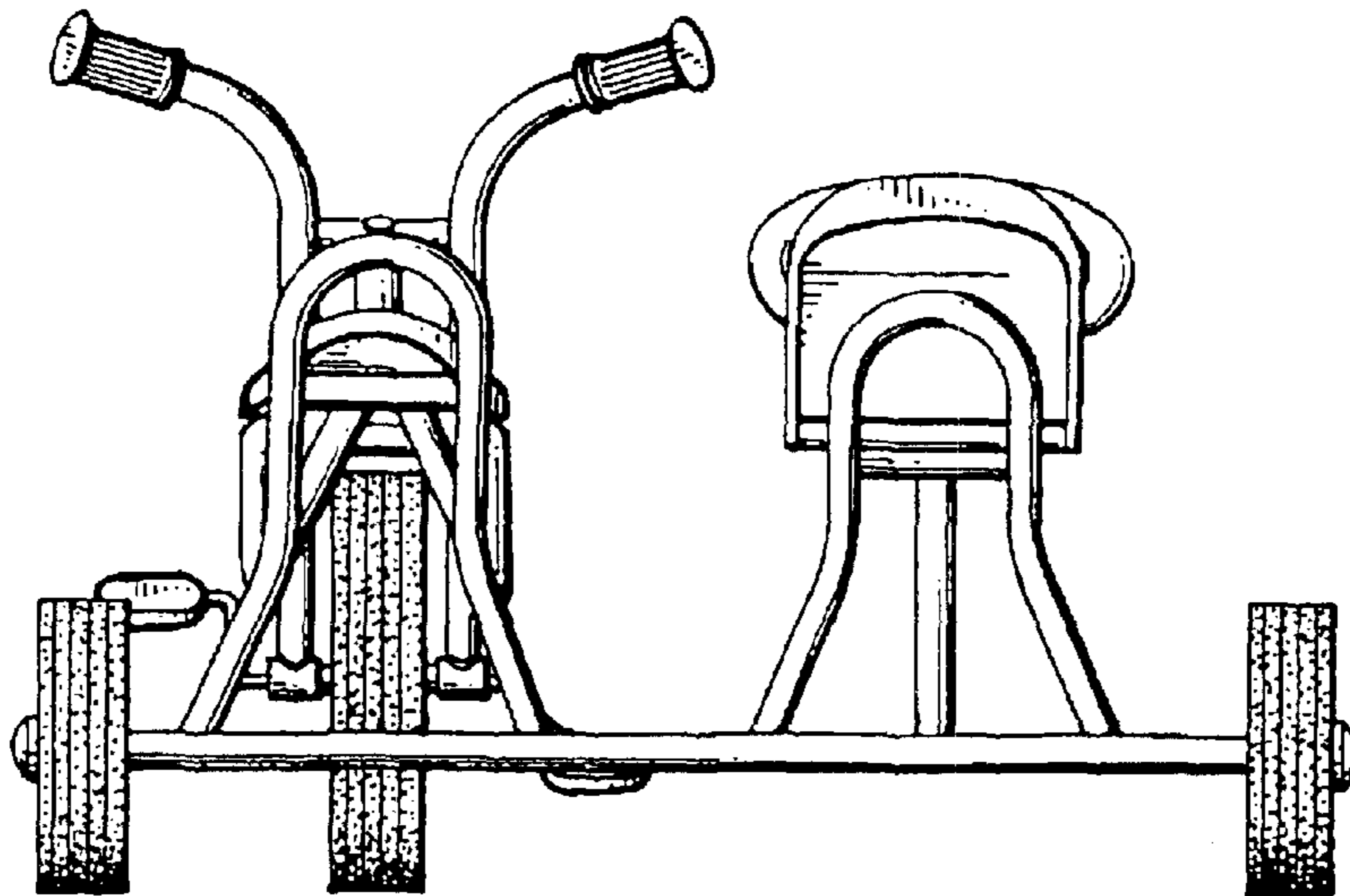

FIG. 3

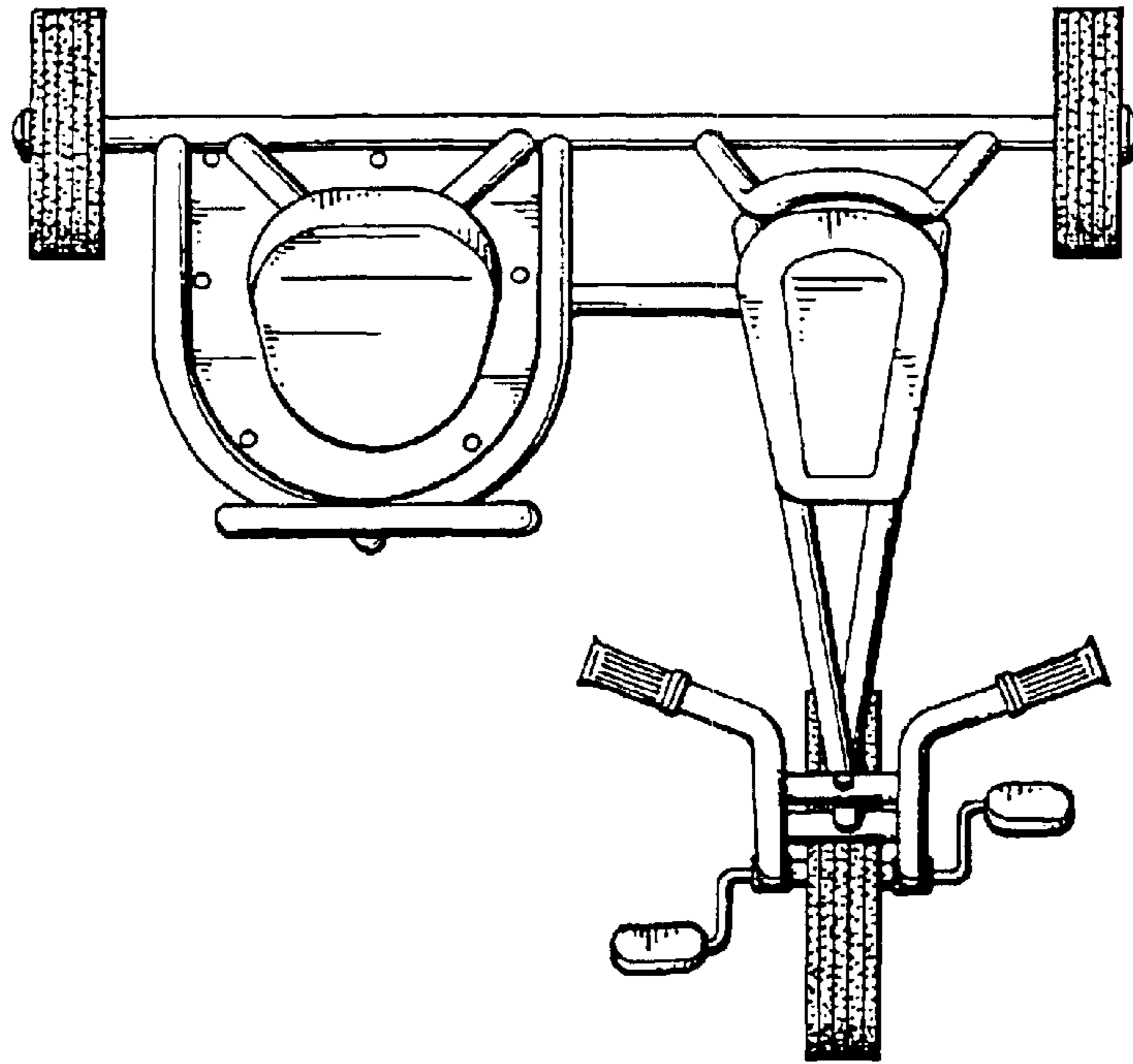

FIG. 4

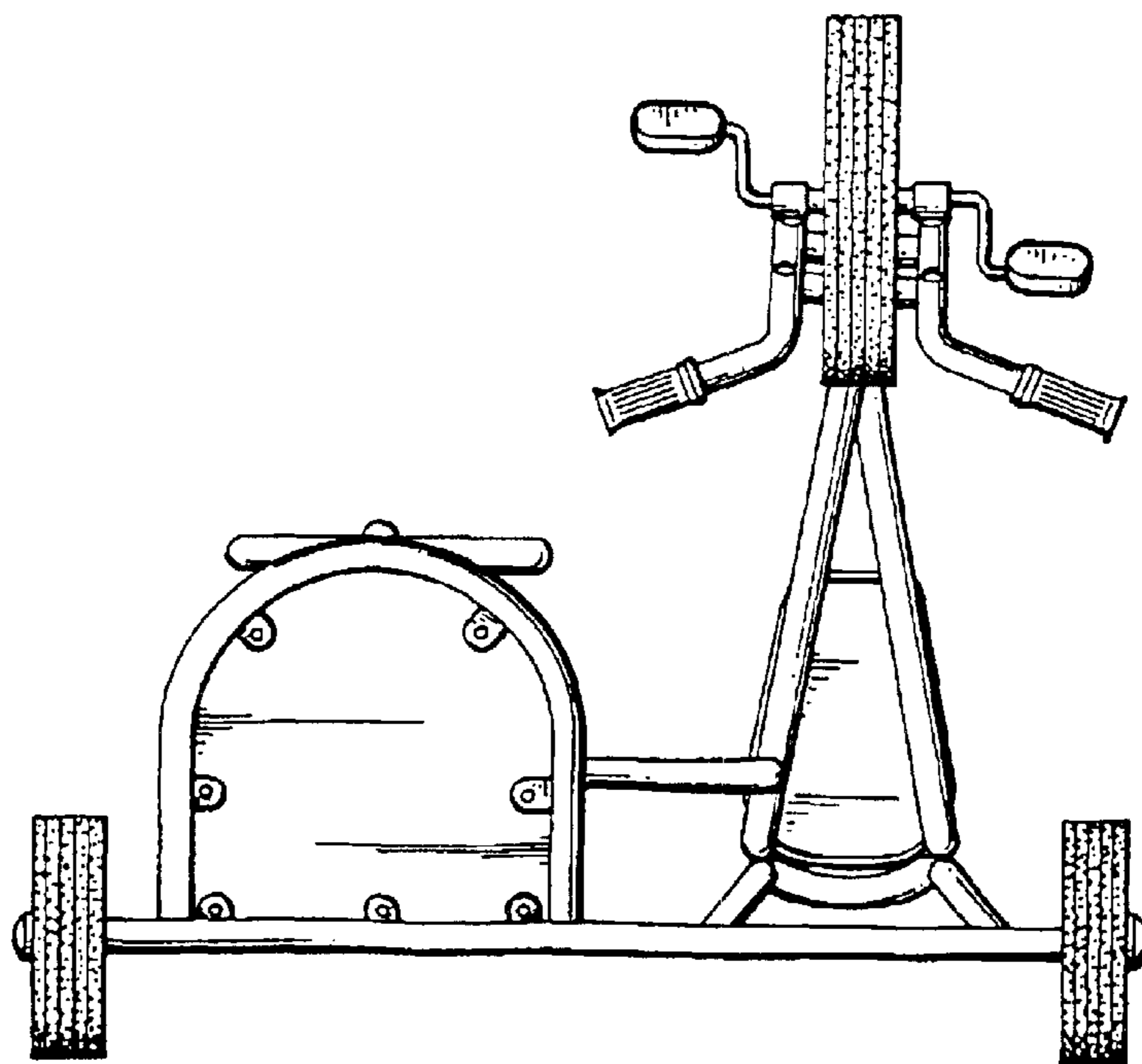

FIG. 5

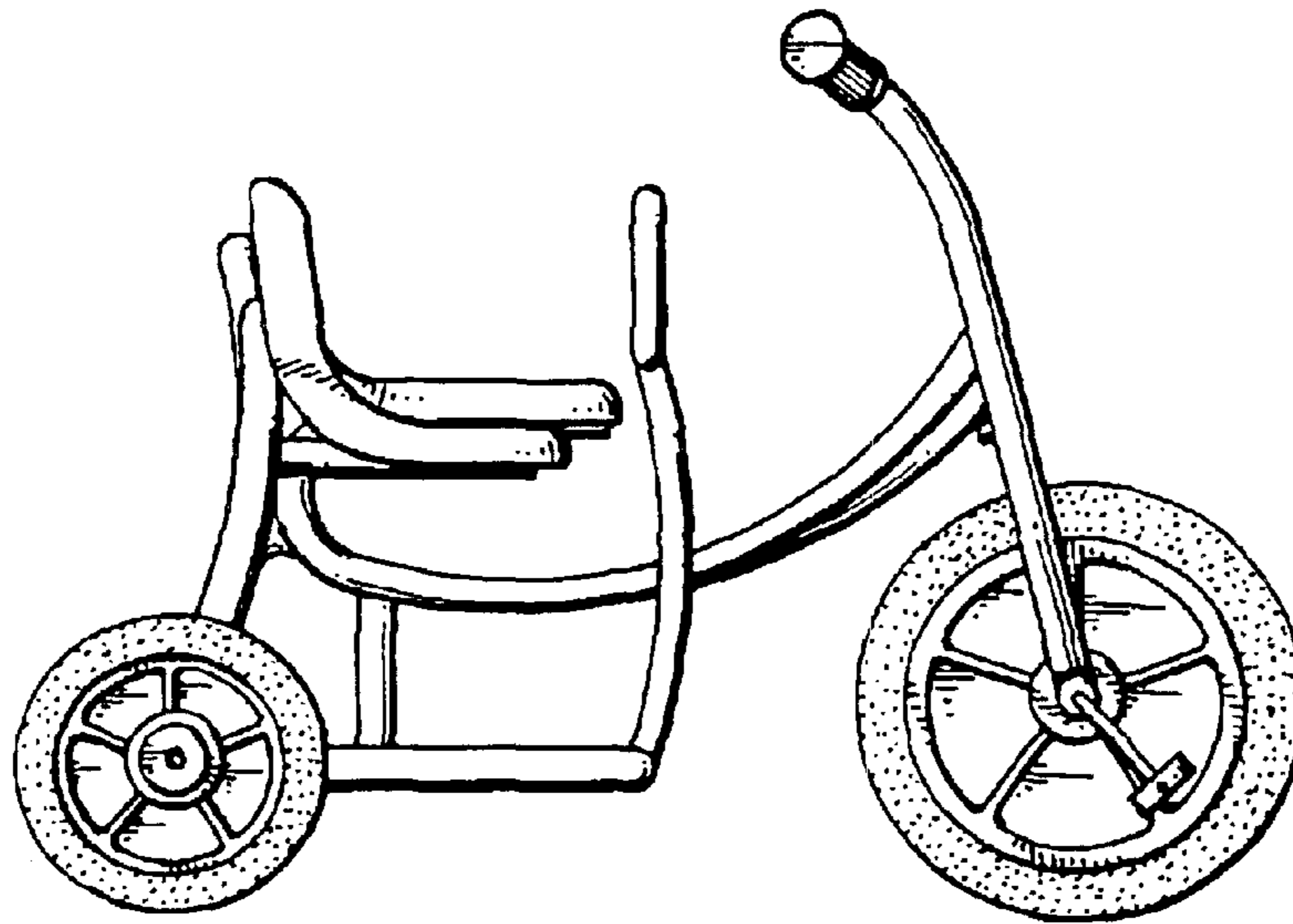

FIG. 6

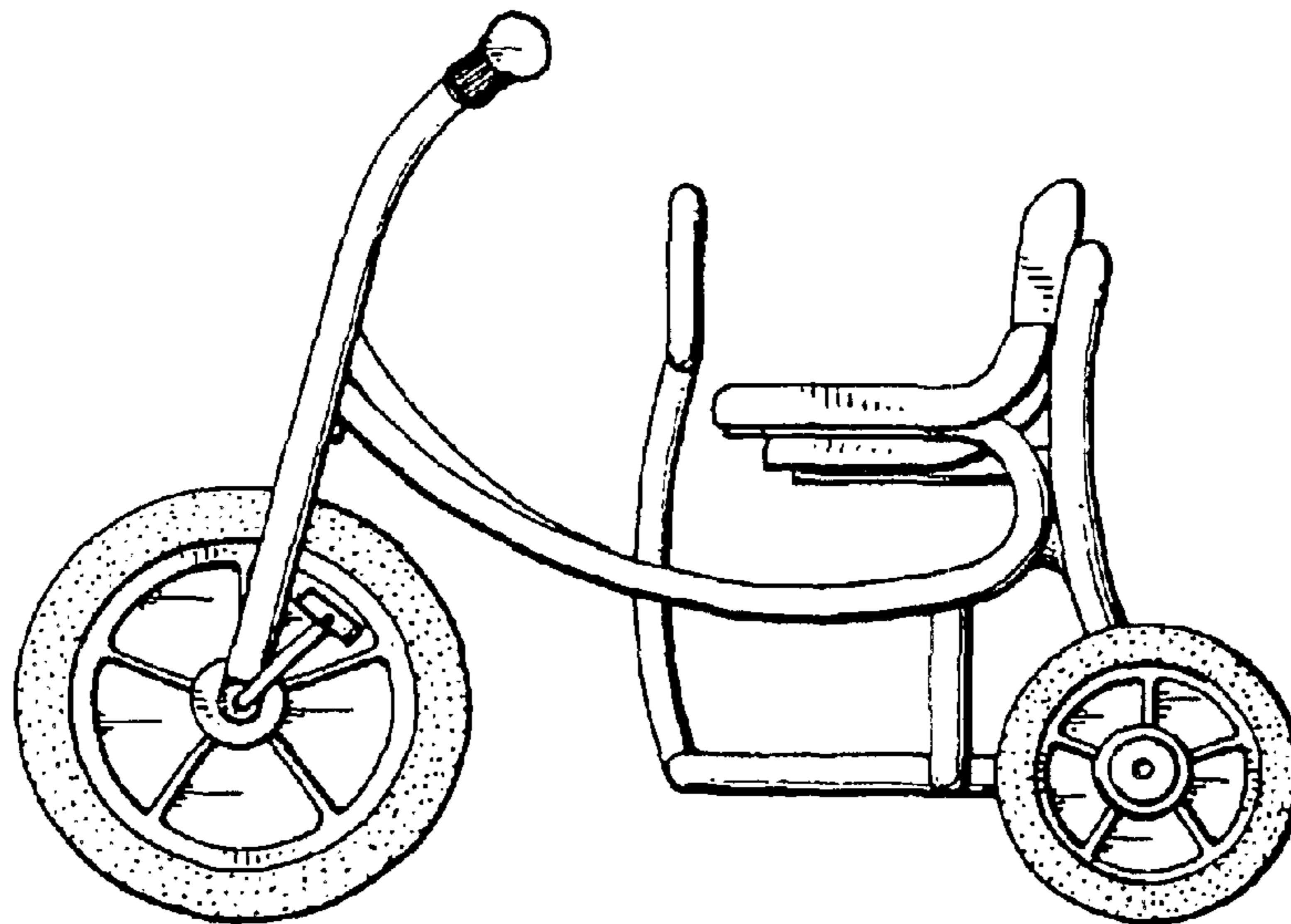

FIG. 7