



US00D497317S1

(12) **United States Design Patent**
Lee

(10) **Patent No.:** **US D497,317 S**
(45) **Date of Patent:** **** Oct. 19, 2004**

(54) **TAPE MEASURE**

(76) **Inventor:** **Shih-Lin Lee**, No. 22, Lane 81, Sec. 2,
Tunhwa S. Rd., Taipei (TW)

(**) **Term:** **14 Years**

(21) **Appl. No.:** **29/195,721**

(22) **Filed:** **Dec. 17, 2003**

(51) **LOC (7) Cl.** **10-04**

(52) **U.S. Cl.** **D10/72**

(58) **Field of Search** D10/72; 33/755-770,
33/668; 242/379

(56) **References Cited**

U.S. PATENT DOCUMENTS

D463,300 S	*	9/2002	Li	D10/72
D470,427 S	*	2/2003	Scurry	D10/72
D489,633 S	*	5/2004	Lee	D10/72

* cited by examiner

Primary Examiner—Antoine D. Davis
(74) *Attorney, Agent, or Firm*—Rosenberg, Klein & Lee

(57) **CLAIM**

The ornamental design for a tape measure, as shown.

DESCRIPTION

FIG. 1 is a front right perspective view of a tape measure showing my new design;

FIG. 2 is a front perspective view thereof;

FIG. 3 is a rear perspective view thereof;

FIG. 4 is a left side elevation view thereof;

FIG. 5 is a right side elevation view thereof;

FIG. 6 is a top plan view thereof; and,

FIG. 7 is a bottom plan view thereof.

1 Claim, 5 Drawing Sheets

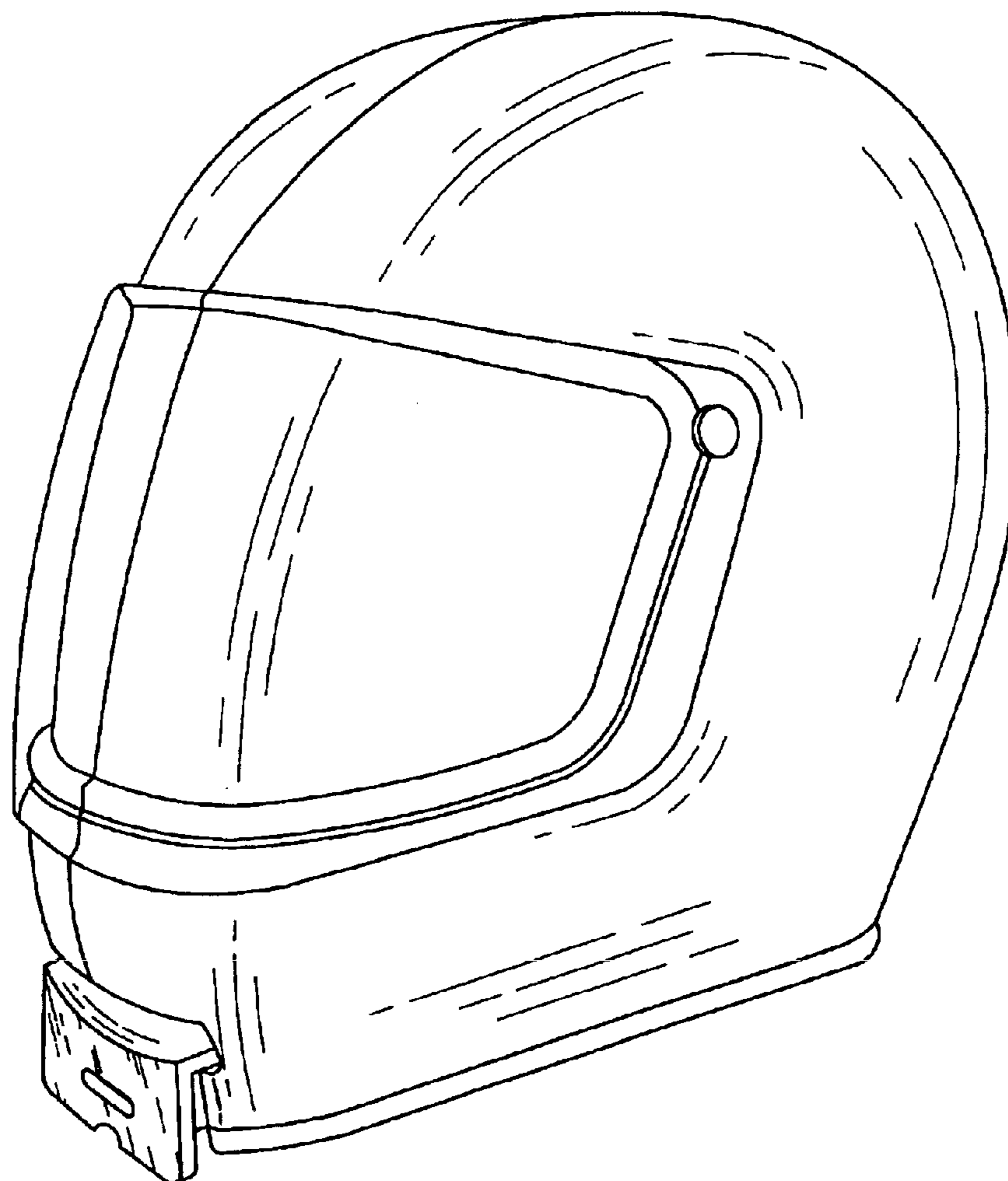

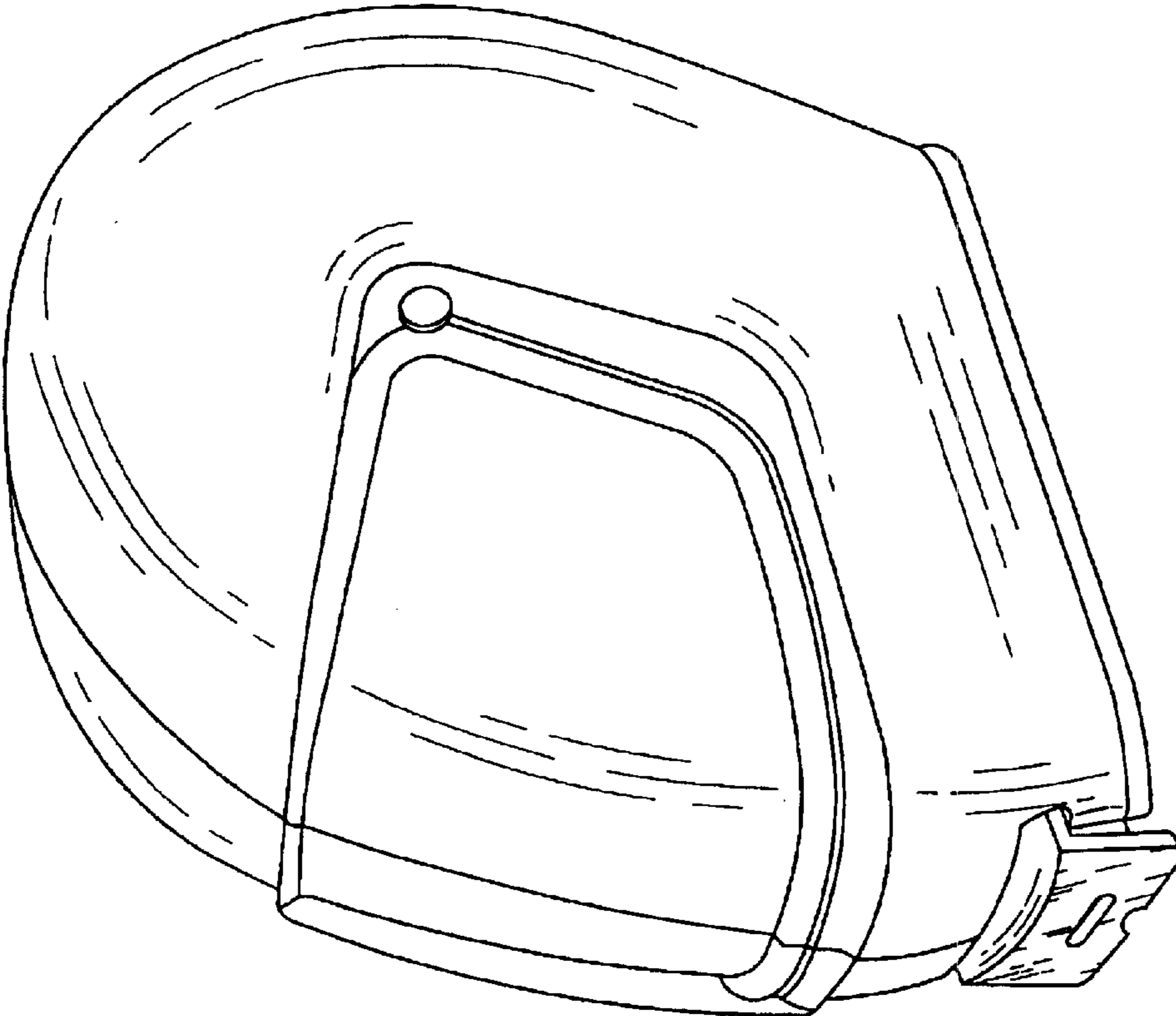

FIG. 1

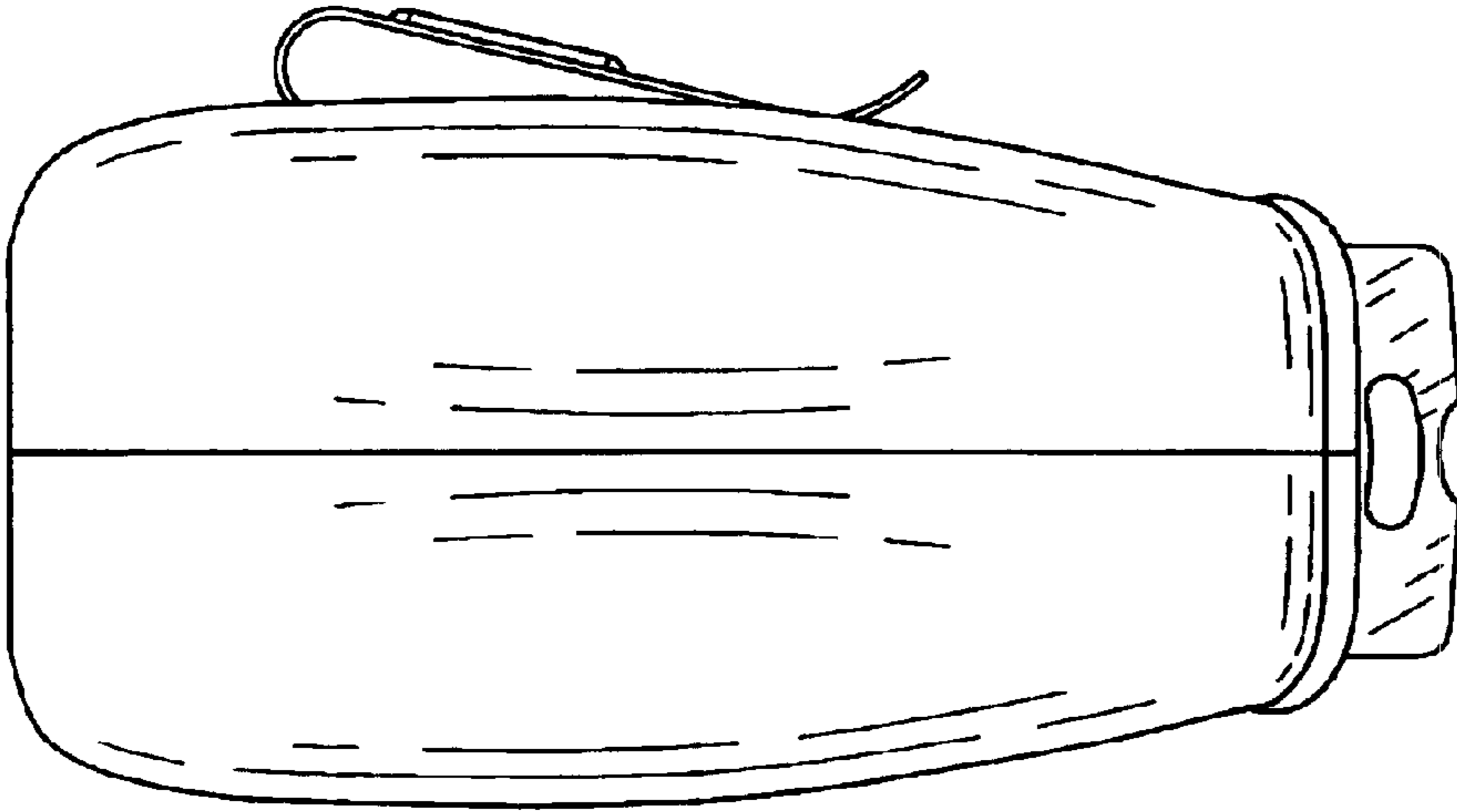

FIG. 3

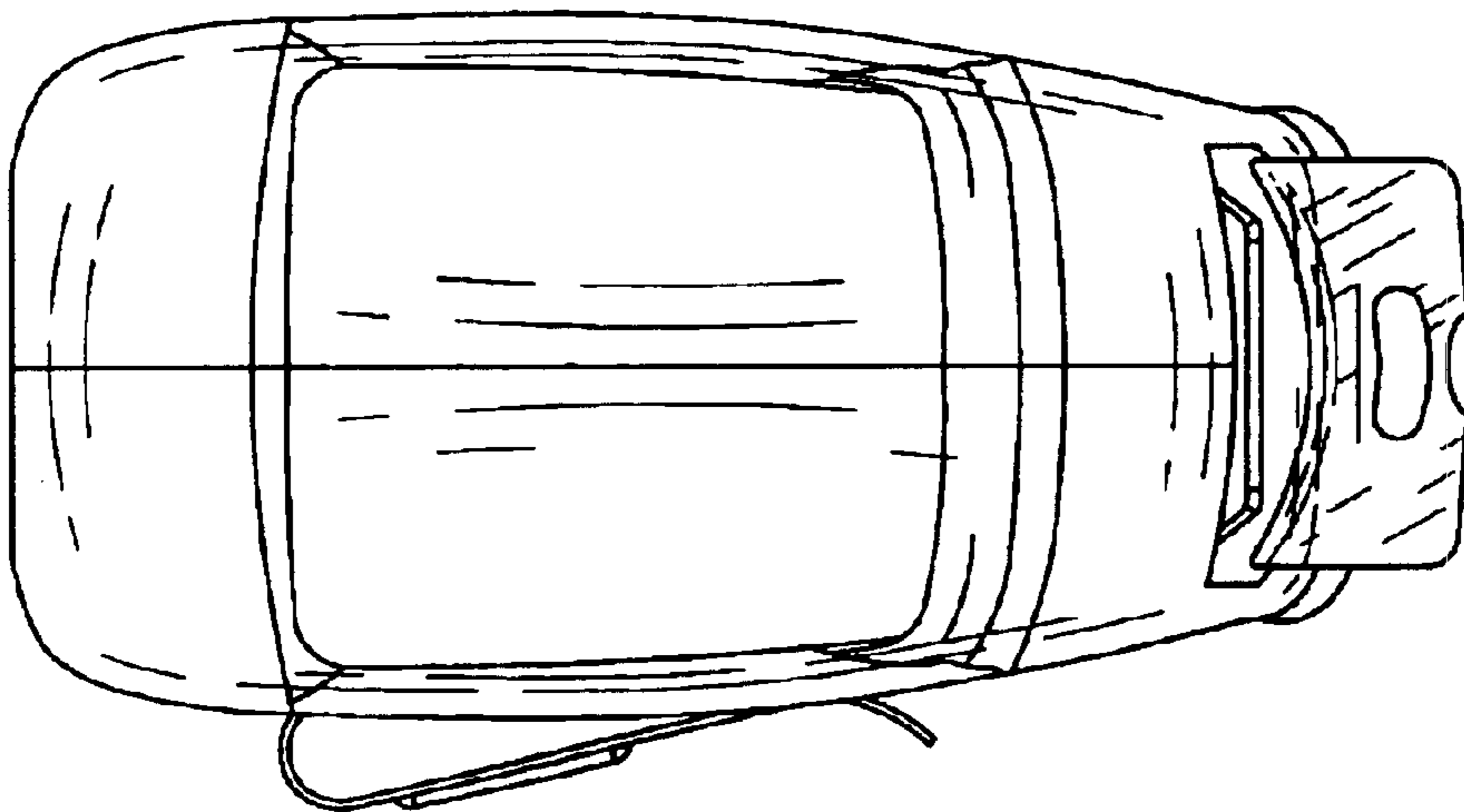

FIG. 2

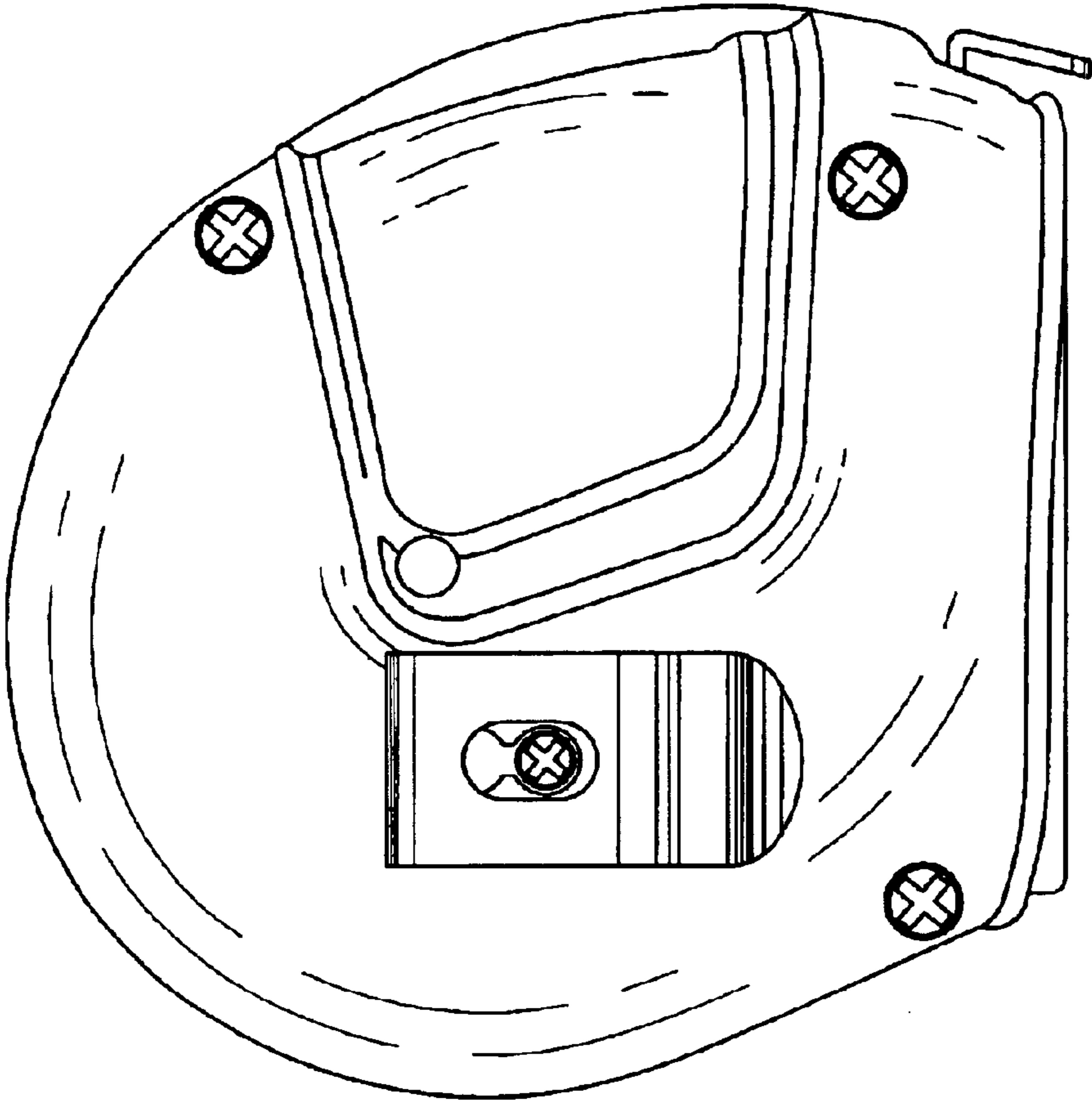

FIG. 4

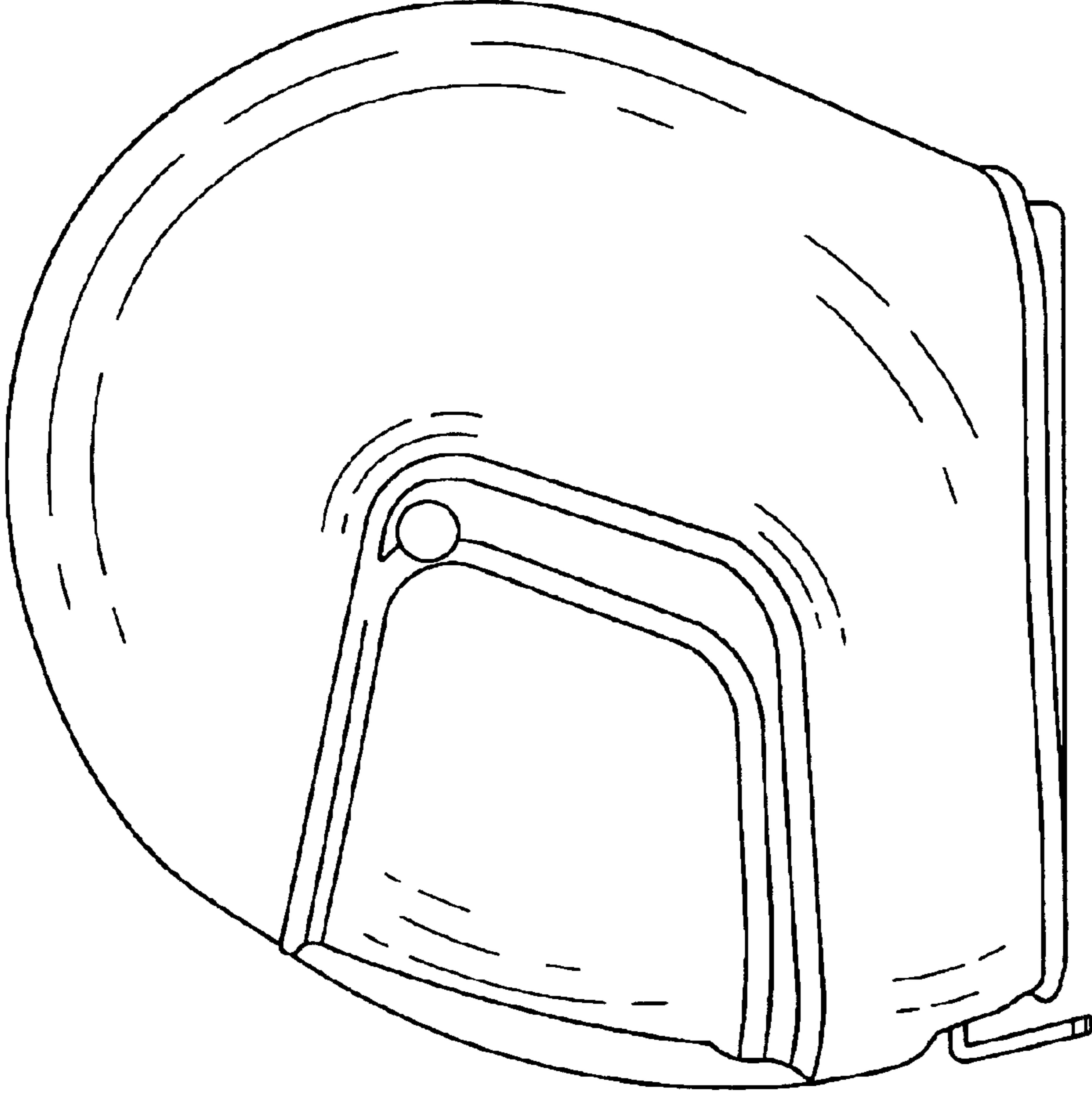

FIG. 5

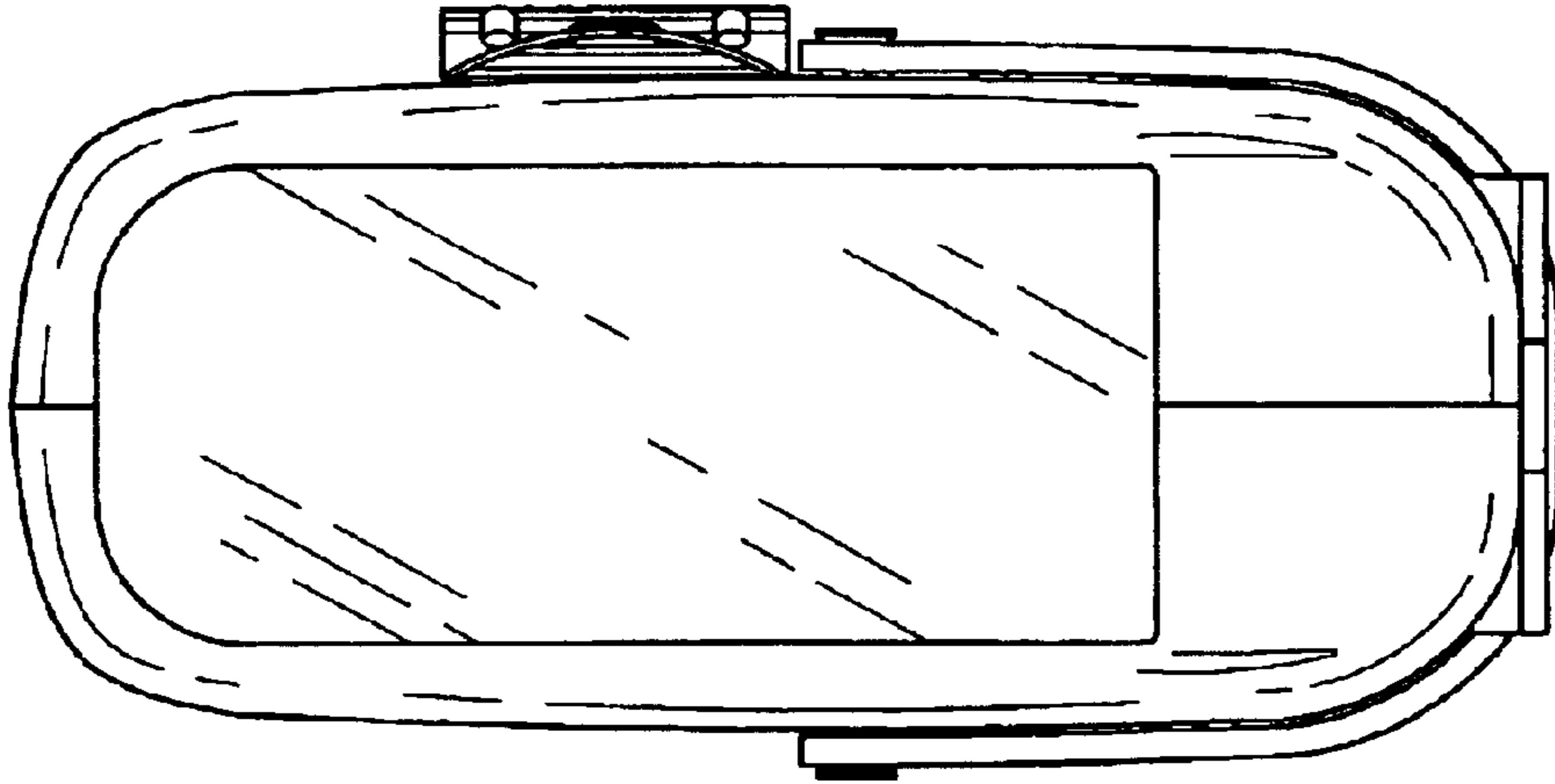

FIG. 6

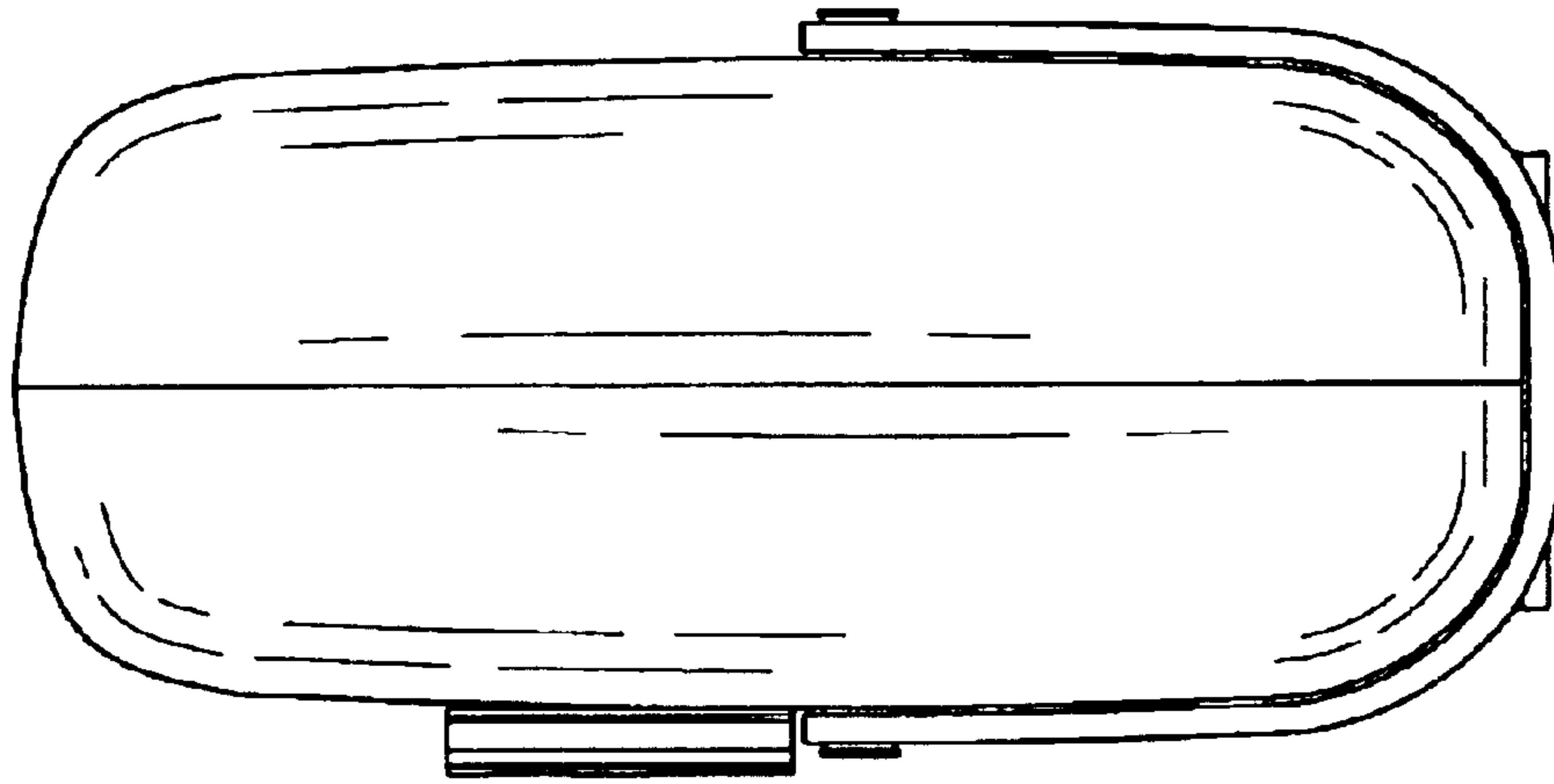

FIG. 7