

US00D497288S1

(12) **United States Design Patent**  
**McGuyer**

(10) **Patent No.:** **US D497,288 S**  
(45) **Date of Patent:** **\*\* Oct. 19, 2004**

(54) **CONDIMENT DISPENSING CAROUSEL**

D464,533 S 10/2002 McGuyer

(75) Inventor: **Carter W. McGuyer**, Muscle Shoals,  
AL (US)

\* cited by examiner

(73) Assignee: **Robbins Industries, Inc.**, Florence, AL  
(US)

*Primary Examiner*—Terry A. Wallace  
(74) *Attorney, Agent, or Firm*—Kramer Levin Naftalis &  
Frankel LLP; Gregor N. Neff

(\*\*) Term: **14 Years**

(57) **CLAIM**

(21) Appl. No.: **29/180,807**

The ornamental design for a condiment dispensing carousel,  
as shown and described.

(22) Filed: **Apr. 30, 2003**

**DESCRIPTION**

(51) **LOC (7) Cl.** ..... **07-06**

(52) **U.S. Cl.** ..... **D7/590; D7/600.1**

(58) **Field of Search** ..... D7/590–600.4,  
D7/701, 707, 708; 211/77, 78, 115, 163,  
131.1, 74; 222/142.1–142.9, 132, 144, 180,  
181.1, 368

FIG. 1 is a perspective view of the condiment dispensing carousel showing my new design; FIG. 2 is a top plan view thereof; FIG. 3 is a front elevation view thereof; FIG. 4 is a perspective view of the carousel shown without the dispensers for clarity of illustration; FIG. 5 is a perspective view of the dispenser shown separately for clarity of illustration; FIG. 6 is a top plan view of FIG. 5; FIG. 7 is a front elevation of FIG. 5; FIG. 8 is a perspective view of FIG. 5 in an open position; and, FIG. 9 is a front elevation view of an alternate embodiment of FIG. 1, the difference being that there are the dispensing carousels are stacked on top of each other. The undisclosed bottom views of the carousel and dispensers are unadorned.

(56) **References Cited**

**U.S. PATENT DOCUMENTS**

150,718	A	*	5/1874	Seavey	.....	211/77
3,088,714	A	*	5/1963	Isreeli	.....	211/74
D290,573	S	*	6/1987	Drummond et al.	.....	D7/600
D392,852	S		3/1998	Weterrings et al.		
D398,482	S	*	9/1998	Wang	.....	D7/590
D402,849	S		12/1998	Weterrings et al.		
D403,923	S		1/1999	Weterrings et al.		
D407,610	S		4/1999	Weterrings et al.		
5,894,944	A	*	4/1999	Swift	.....	211/78
6,182,839	B1		2/2001	Robbins et al.		

**1 Claim, 6 Drawing Sheets**

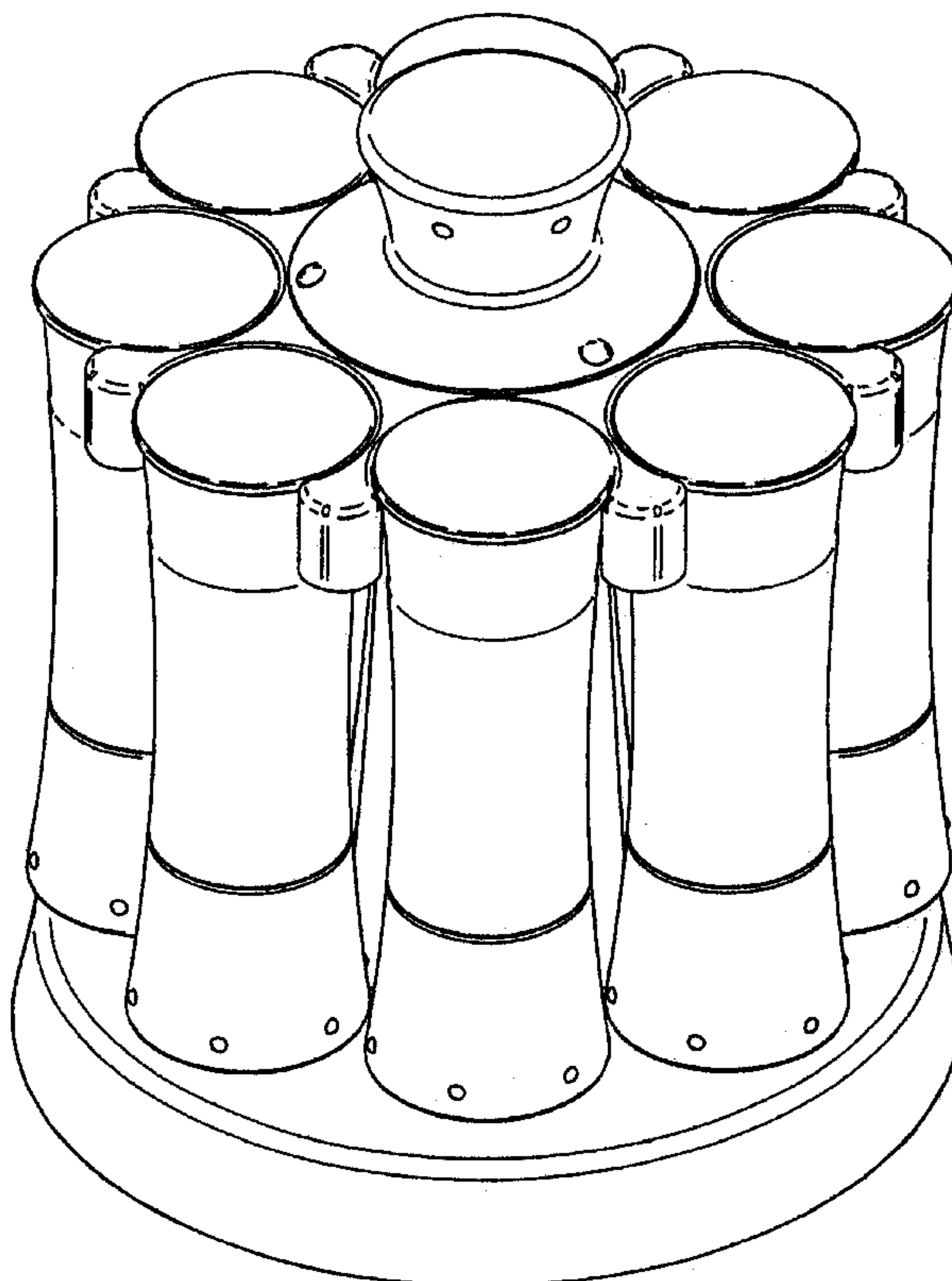

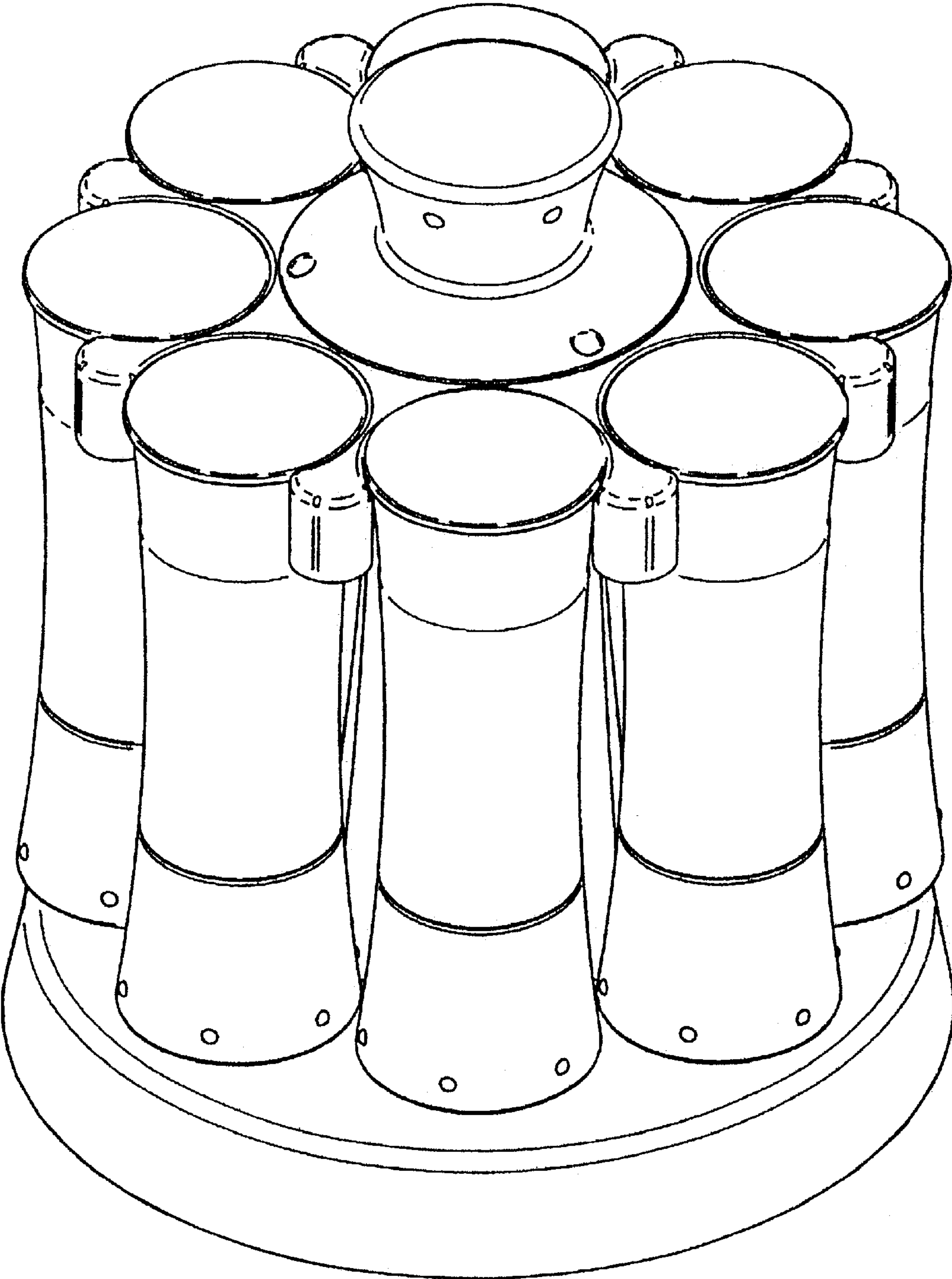

FIG.1

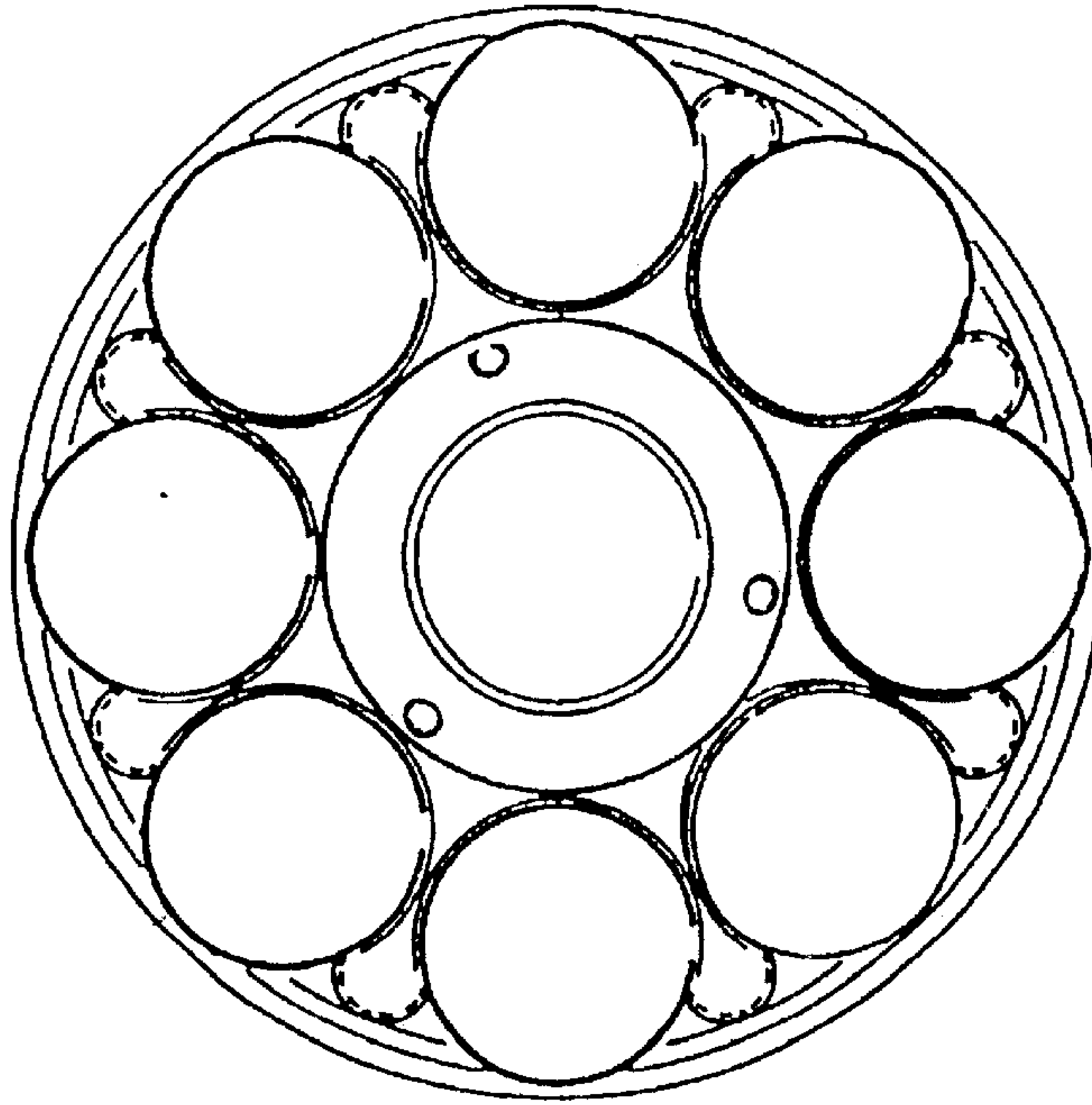

FIG. 2

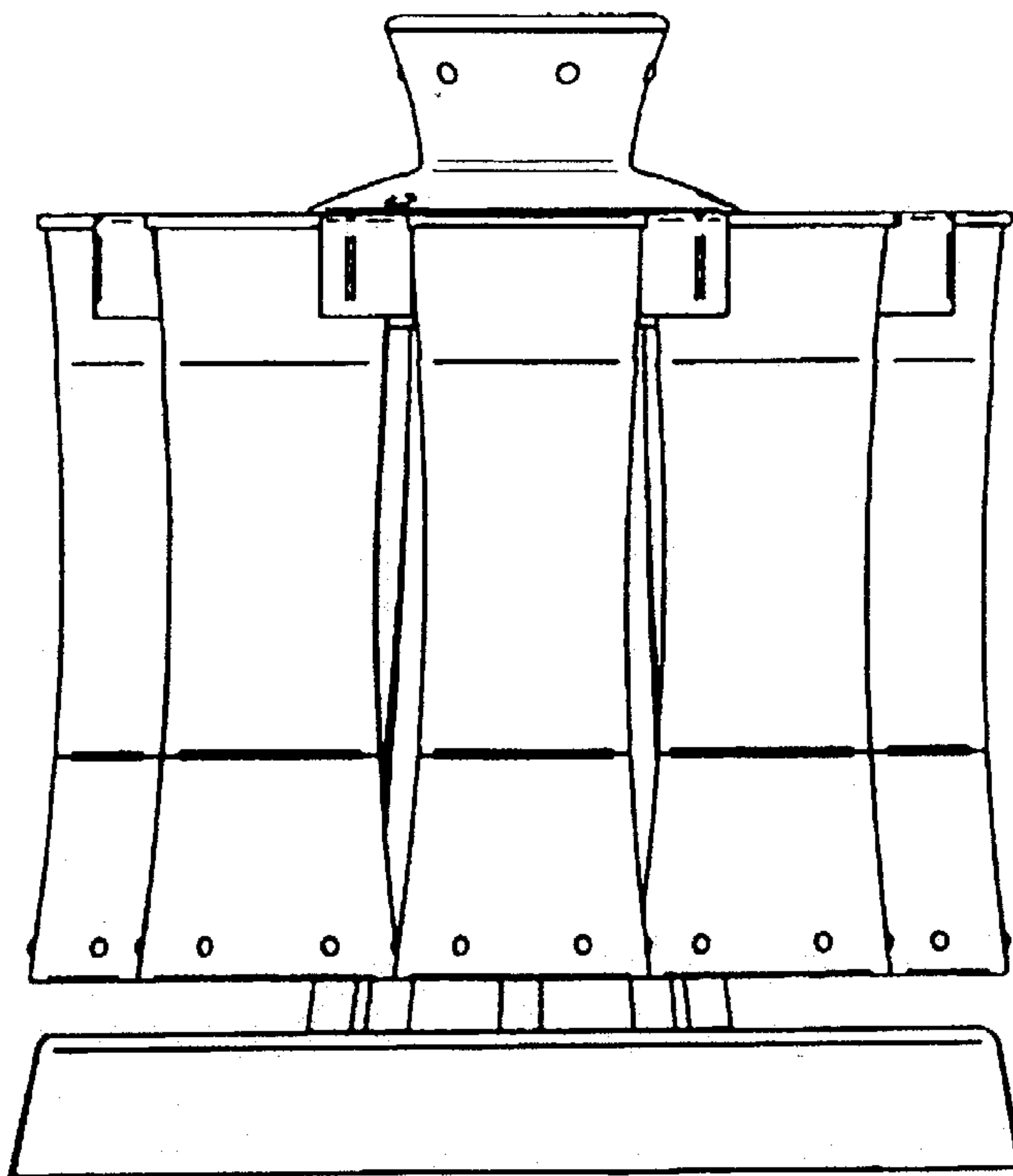

FIG. 3

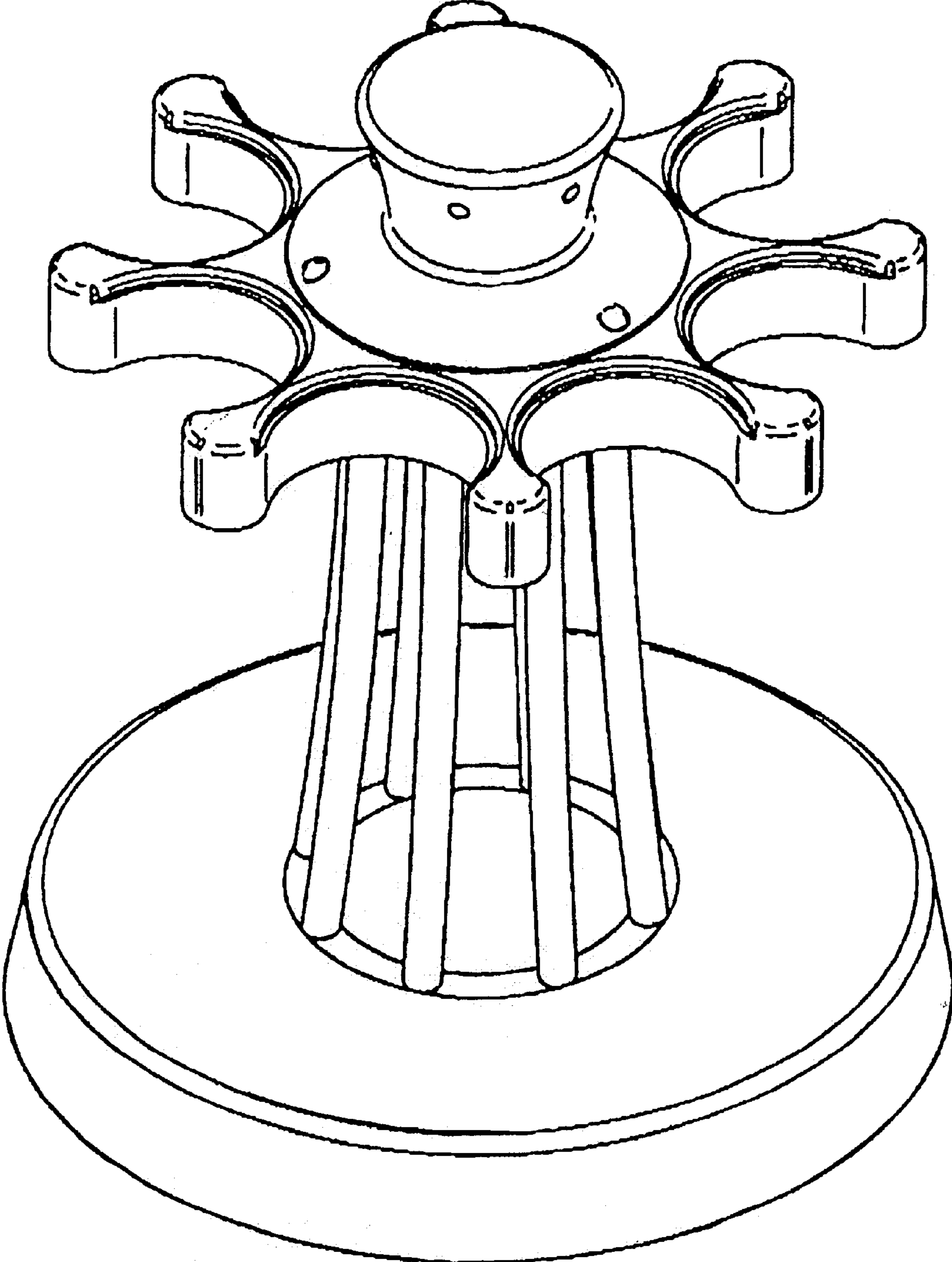

FIG.4

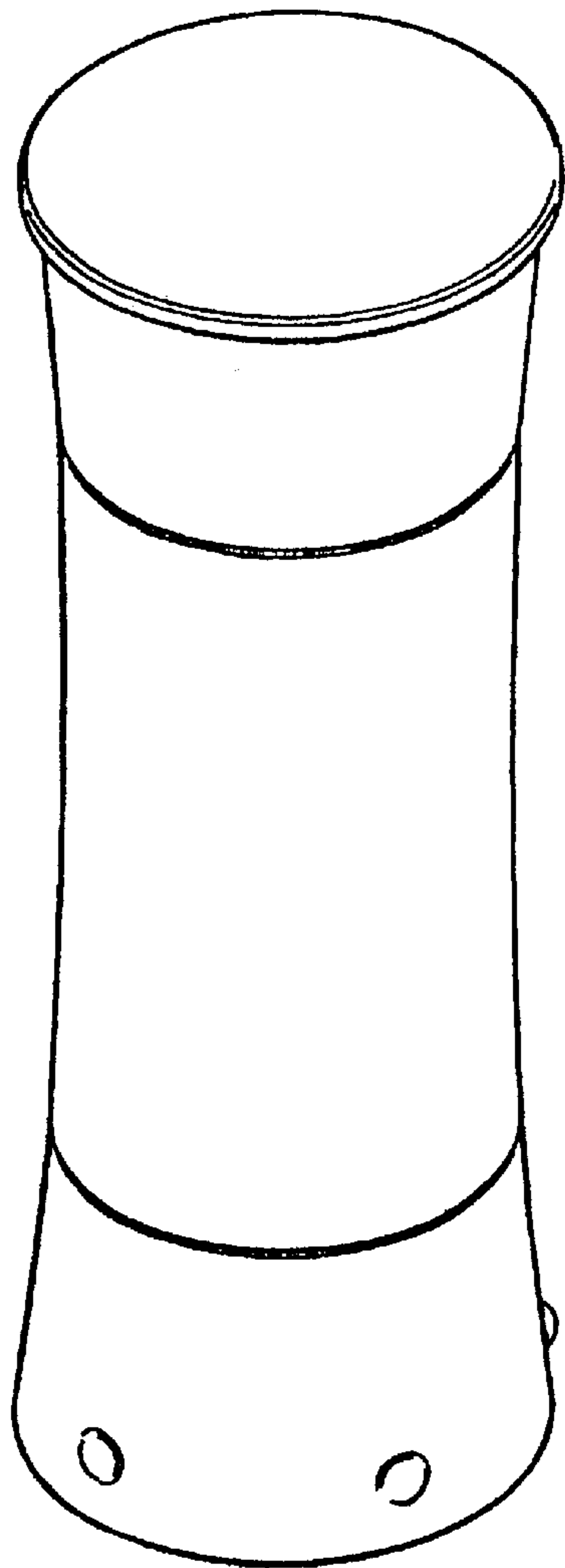

FIG. 5

FIG. 6

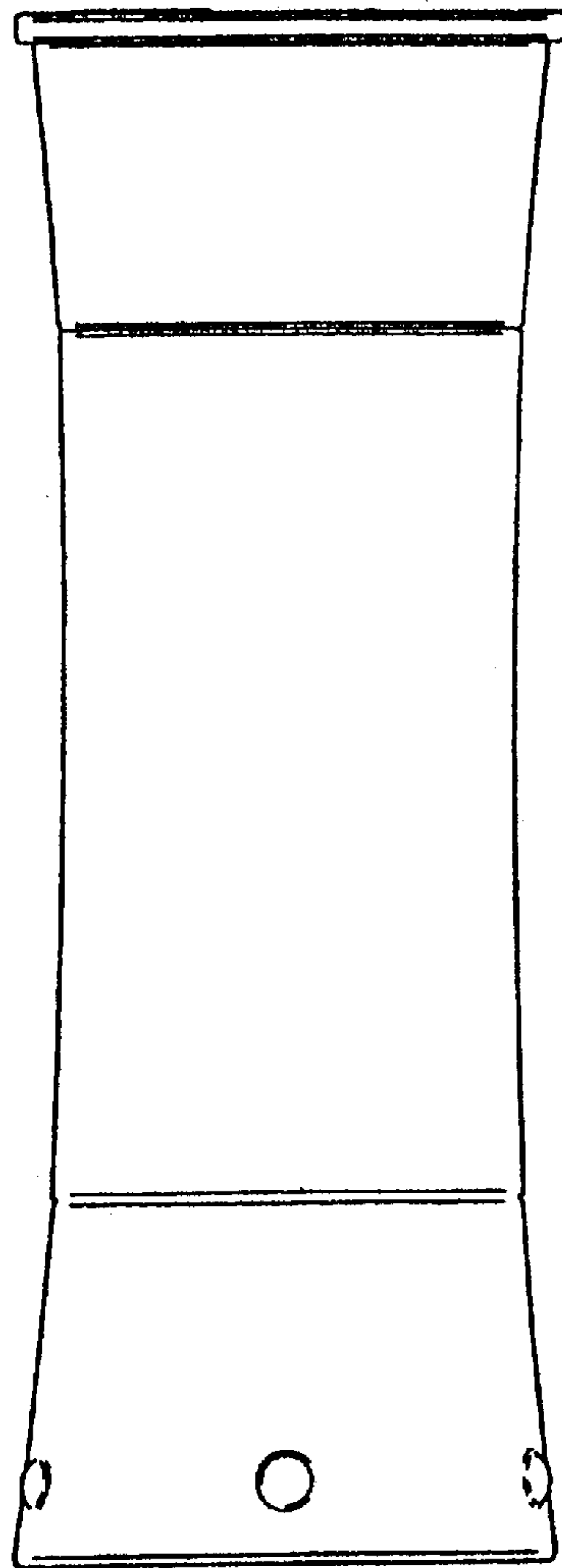
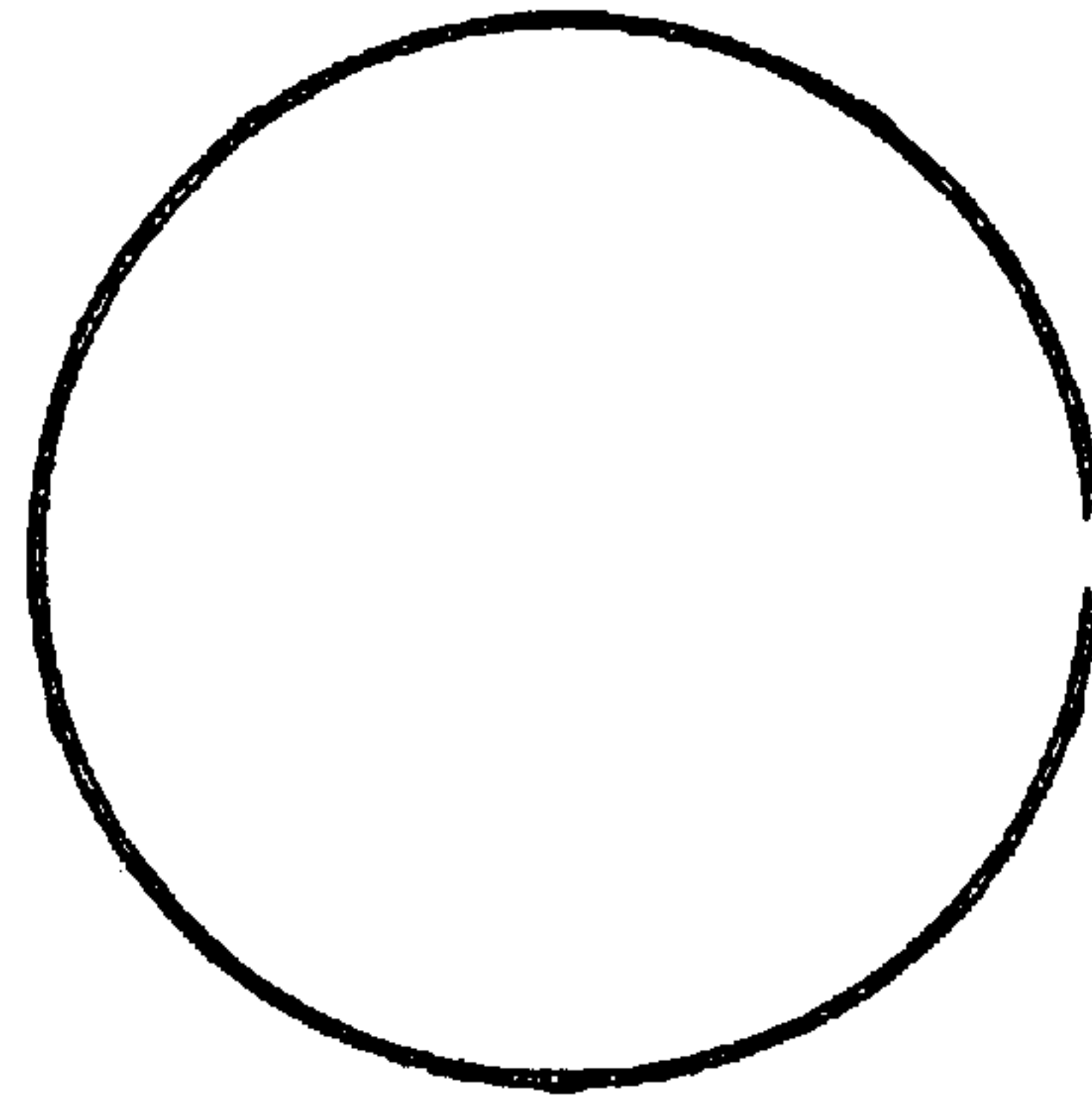

FIG. 7



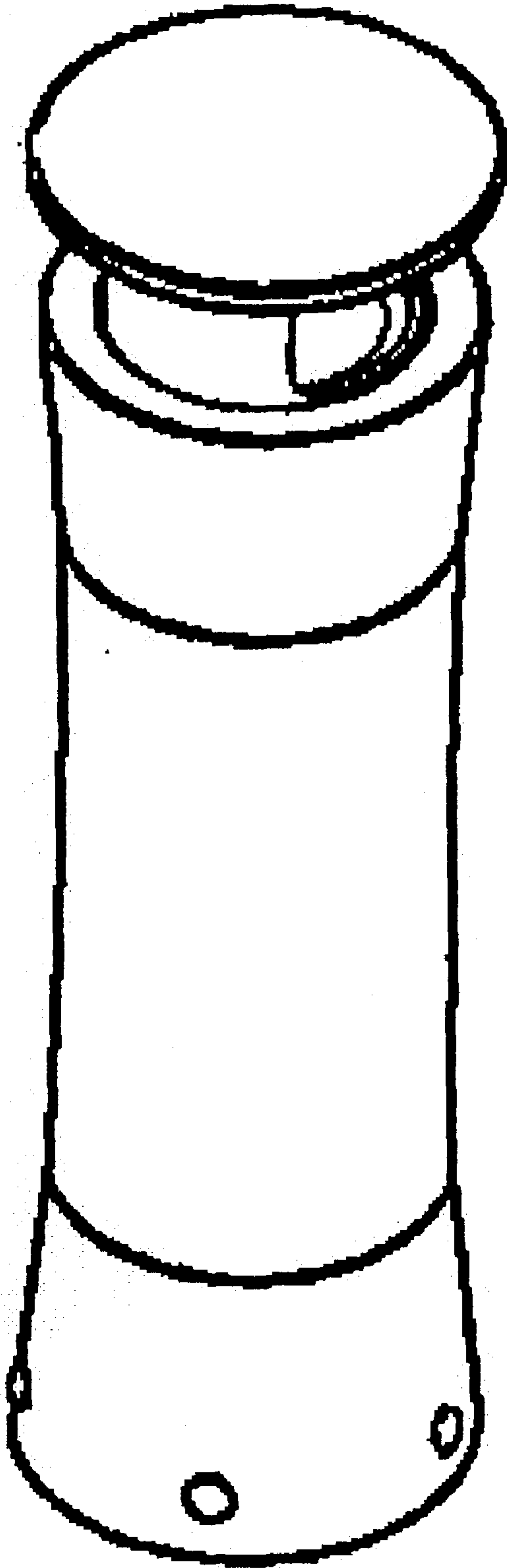

FIG.8

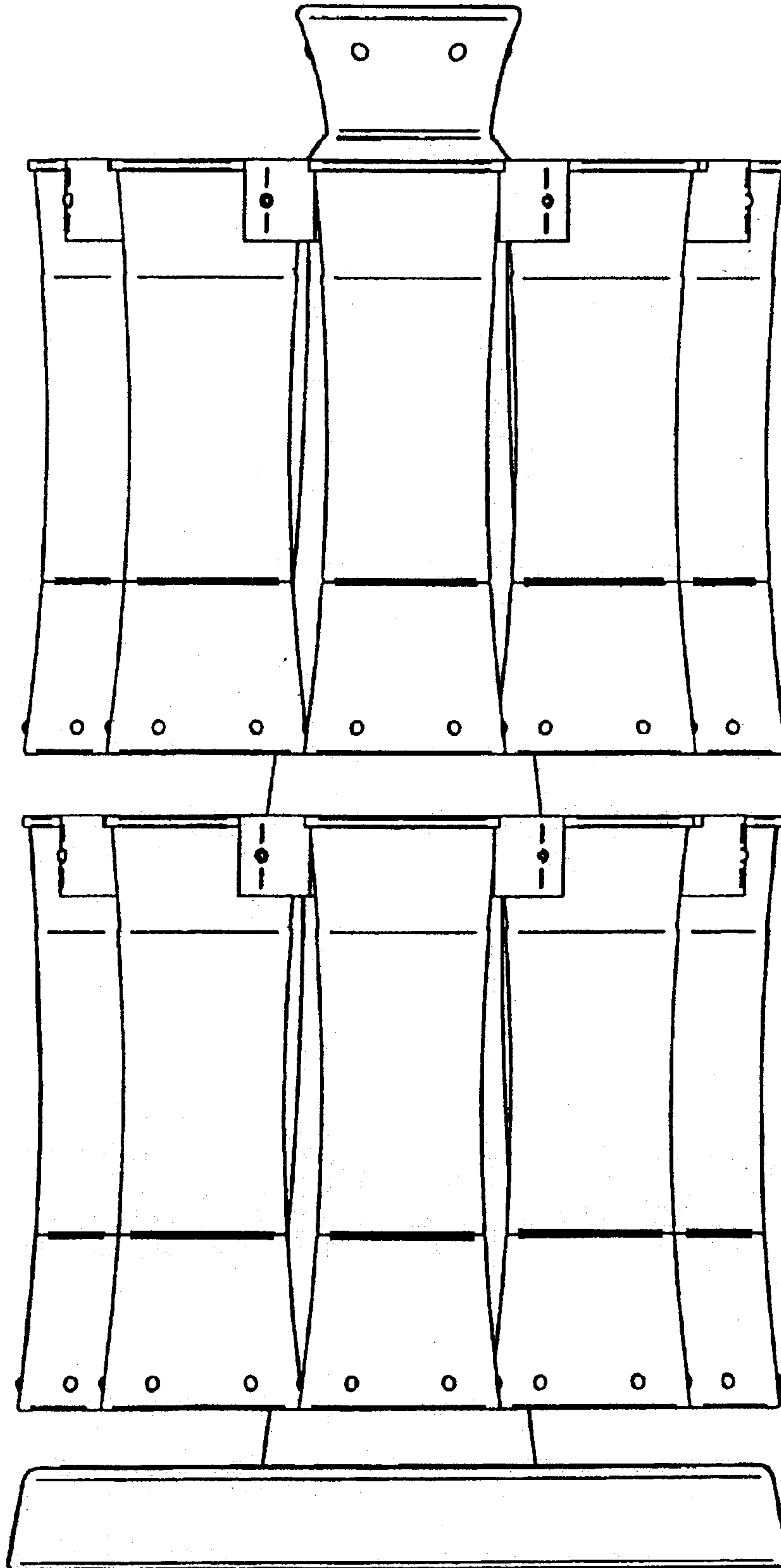

FIG.9