

US00D497223S1

(12) **United States Design Patent** (10) **Patent No.:** **US D497,223 S**
Kalhok (45) **Date of Patent:** **** Oct. 12, 2004**

(54) **FULL-FACE HELMET**

- (75) Inventor: **David Kalhok**, Marion, IL (US)
(73) Assignee: **Bombardier Recreational Products Inc.**, Valcourt (CA)
(**) Term: **14 Years**
(21) Appl. No.: **29/148,772**
(22) Filed: **Sep. 20, 2001**

Related U.S. Application Data

- (62) Division of application No. 29/099,598, filed on Jan. 25, 1999, now Pat. No. Des. 450,160.

(30) **Foreign Application Priority Data**

- Dec. 22, 1998 (CA) 1998-3127
(51) **LOC (7) Cl.** **29-02**
(52) **U.S. Cl.** **D29/122; D29/107**
(58) **Field of Search** **D29/102-107, D29/122; 2/414, 418, 423, 424, 425, 9, 455**

(56) **References Cited**

U.S. PATENT DOCUMENTS

- 1,706,602 A 3/1929 Drager
2,317,608 A 4/1943 Heidbrink
2,348,277 A 5/1944 Boothby et al.

(List continued on next page.)

FOREIGN PATENT DOCUMENTS

- | | | |
|----|------------|---------|
| CA | 2 065 300 | 8/1990 |
| DE | 28 46 636 | 4/1980 |
| DE | 44 16 921 | 11/1995 |
| EP | 0371858 | 6/1990 |
| EP | 0 590 255 | 4/1994 |
| EP | 0 638 253 | 2/1995 |
| GB | 2 052 244 | 1/1981 |
| WO | WO94/05175 | 3/1994 |

OTHER PUBLICATIONS

Search Report for European Patent Application No. 01130658.6-2314, dated May 10, 2002. No drawings. Office Action for Canadian Patent Appln. No. 2,354,131, dated Sep. 6, 2001.

Primary Examiner—Ruth McInroy
(74) *Attorney, Agent, or Firm*—BRP Legal Services

(57) **CLAIM**

I claim the ornamental design for a full-face helmet, as shown and described.

DESCRIPTION

FIG. 1 is a front perspective view of a full-face helmet showing my new design;
FIG. 2 is a front elevation view thereof;
FIG. 3 is a top plan view thereof;
FIG. 4 is a right side elevation view thereof;
FIG. 5 is a left side elevation view thereof;
FIG. 6 is a bottom plan view thereof;
FIG. 7 is a rear elevation view thereof;
FIG. 8 is a front perspective view of a second embodiment thereof;
FIG. 9 is a front elevation view of FIG. 8;
FIG. 10 is a top plan view of FIG. 8;
FIG. 11 is a right side elevation view of FIG. 8;
FIG. 12 is a left side elevation view of FIG. 8;
FIG. 13 is a bottom plan view of FIG. 8;
FIG. 14 is a rear elevation view of FIG. 8;
FIG. 15 is a front perspective view of a third embodiment thereof;
FIG. 16 is a front elevation view of FIG. 15;
FIG. 17 is a top plan view of FIG. 15;
FIG. 18 is a right side elevation view of FIG. 15;
FIG. 19 is a left side elevation view of FIG. 15;
FIG. 20 is a bottom plan view of FIG. 15; and,
FIG. 21 is a rear elevation view of FIG. 15.
Where indicated, dotted lines showing structure form no part of the claimed design.

1 Claim, 12 Drawing Sheets

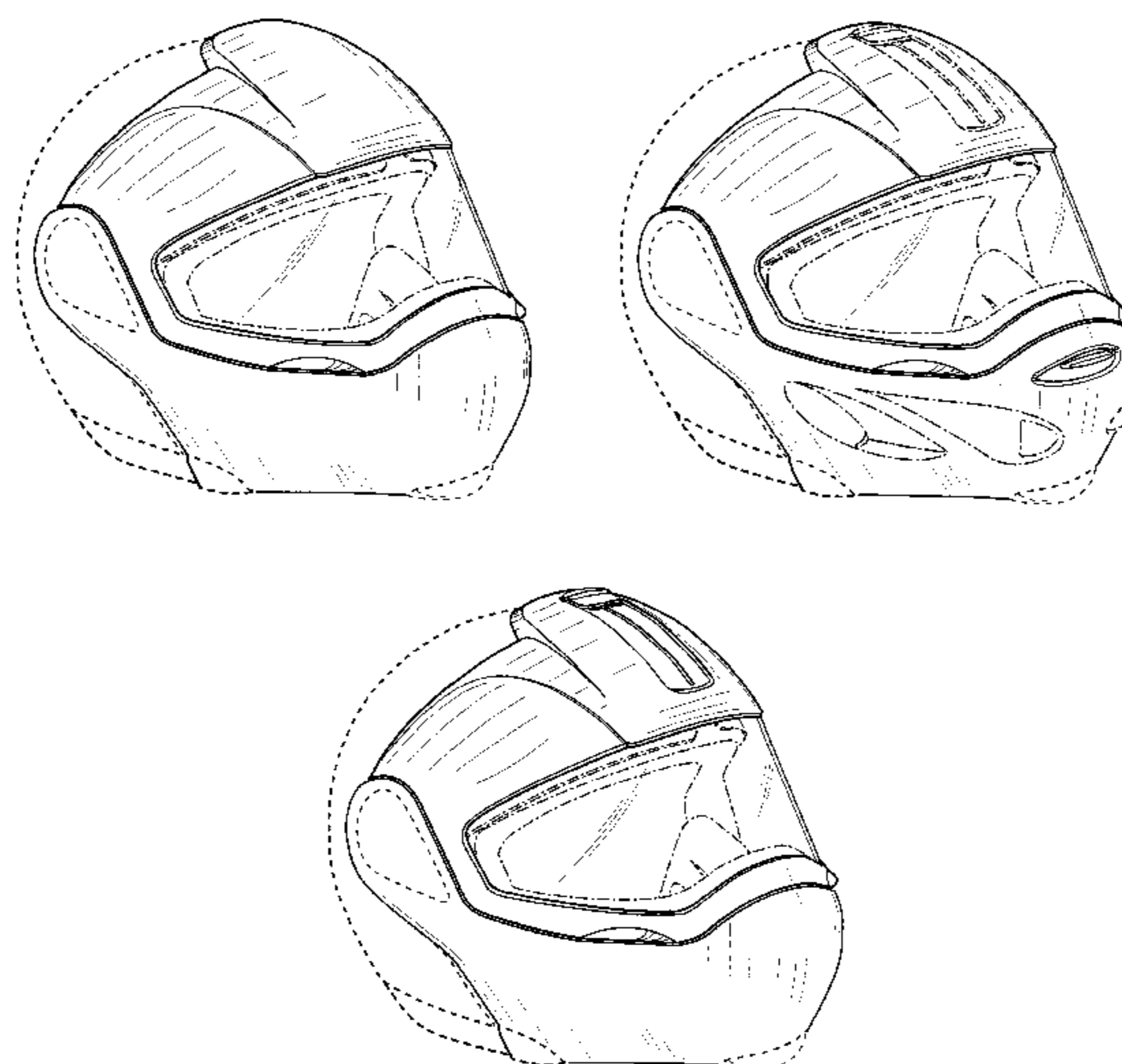

US D497,223 S

Page 2

U.S. PATENT DOCUMENTS

2,867,812 A	1/1959	Roth et al.	D351,685 S	10/1994	Kamata
3,065,747 A	11/1962	Forkel	5,351,339 A	10/1994	Reuber et al.
3,110,034 A	11/1963	Aileo	5,394,566 A	3/1995	Hong
3,237,202 A	3/1966	Aileo	5,396,661 A	3/1995	Sutter et al.
3,239,843 A	3/1966	Lobelle	D361,867 S	8/1995	Taniuchi
3,310,811 A	3/1967	Iacono, Jr.	5,444,875 A	8/1995	Taniuchi
3,351,056 A	11/1967	Durney	5,500,953 A	3/1996	Reuber et al.
3,400,407 A	9/1968	Aileo	5,515,843 A	5/1996	Chang
3,721,994 A	3/1973	DeSimone et al.	5,538,001 A	7/1996	Bridges
3,768,100 A	10/1973	Colman et al.	5,549,104 A	8/1996	Crump et al.
3,971,368 A	7/1976	Forbes et al.	5,555,569 A	9/1996	Lane
4,170,042 A	10/1979	Aileo	5,584,073 A	12/1996	Radzelovage et al.
4,195,328 A	3/1980	Harris, Jr.	5,603,317 A	2/1997	Farmer
4,315,335 A	2/1982	Kennedy, Jr. et al.	5,619,755 A	4/1997	Casartelli
4,400,591 A	8/1983	Jennings et al.	5,630,412 A	5/1997	Dubruille et al.
4,514,864 A	5/1985	Huber	5,649,532 A	7/1997	Griffiths
4,555,815 A	12/1985	Walther	5,653,225 A	8/1997	Schegerin
4,556,994 A	12/1985	Kawasaki et al.	5,680,656 A	10/1997	Gath
4,579,113 A	4/1986	McCreadie et al.	5,694,650 A	12/1997	Hong
4,584,721 A	4/1986	Yamamoto	5,722,091 A	3/1998	Keller et al.
4,595,003 A	6/1986	Shoemaker et al.	5,758,639 A	6/1998	Ikonen
4,598,430 A	7/1986	Nava	5,765,235 A	6/1998	Arnold
4,667,348 A	5/1987	Sundahl	5,794,260 A	8/1998	Schegerin
4,676,236 A	6/1987	Piorkowski et al.	5,797,146 A	8/1998	Matich
4,689,836 A	9/1987	Vitaloni	5,901,369 A	5/1999	Pilney
4,704,746 A	11/1987	Nava	5,910,764 A	6/1999	Hayden
4,734,940 A	4/1988	Galet et al.	D411,900 S	7/1999	Puleo
4,764,990 A	8/1988	Markert	5,924,420 A	7/1999	Reischel et al.
4,803,980 A	2/1989	Nowakowski et al.	5,930,843 A	8/1999	Kelly
4,886,056 A	12/1989	Simpson	D418,255 S	12/1999	Hohdorf
4,907,300 A	3/1990	Dampney et al.	6,047,409 A	4/2000	Simpson
D312,513 S	11/1990	Morin	6,075,857 A	6/2000	Doss, Jr. et al.
5,003,632 A	4/1991	Claude	6,085,358 A	7/2000	Cogan
5,078,130 A	1/1992	Van Oosten et al.	6,161,225 A	12/2000	Arai
5,093,939 A	3/1992	Noyerie et al.	6,249,918 B1	6/2001	Lacroix 2/424
H1039 H	4/1992	Tripp, Jr. et al.	D445,546 S *	7/2001	Gafforio D29/107
5,148,550 A	9/1992	Hodgkinson et al.	D446,357 S *	8/2001	Shida D29/107
D331,299 S	11/1992	Kamata	D447,605 S *	9/2001	Kalhok D29/107
5,187,502 A	2/1993	Howell	D450,160 S *	11/2001	Kalhok D29/107
D334,250 S	3/1993	Gallet	D451,643 S *	12/2001	Kalhok D29/107
D340,545 S	10/1993	Kamata	D452,592 S *	12/2001	Kalhok D29/107
D340,546 S	10/1993	Kamata	6,425,143 B1	7/2002	Benedict et al.
5,291,880 A	3/1994	Almovist et al.			

* cited by examiner

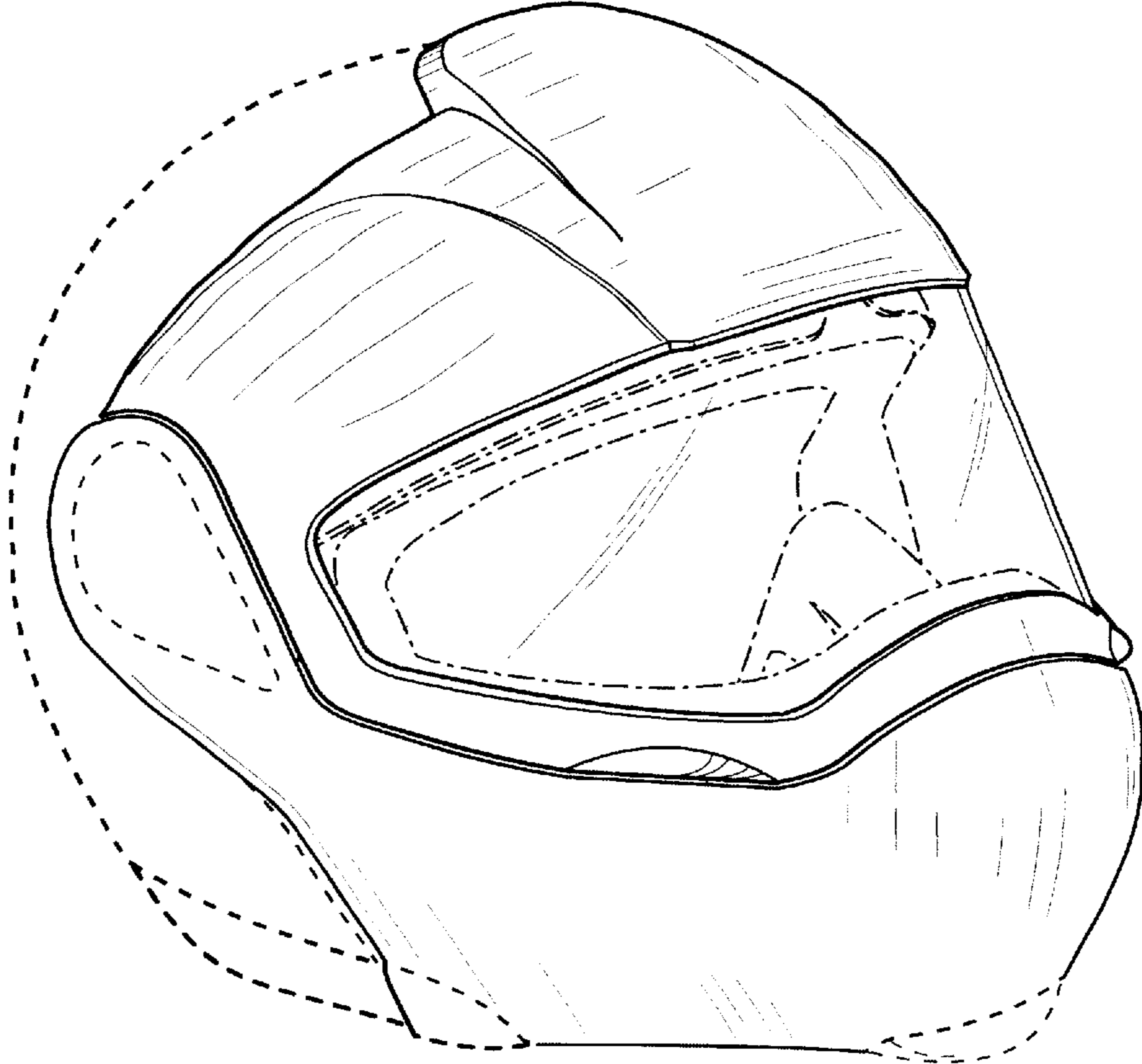

FIG. 1

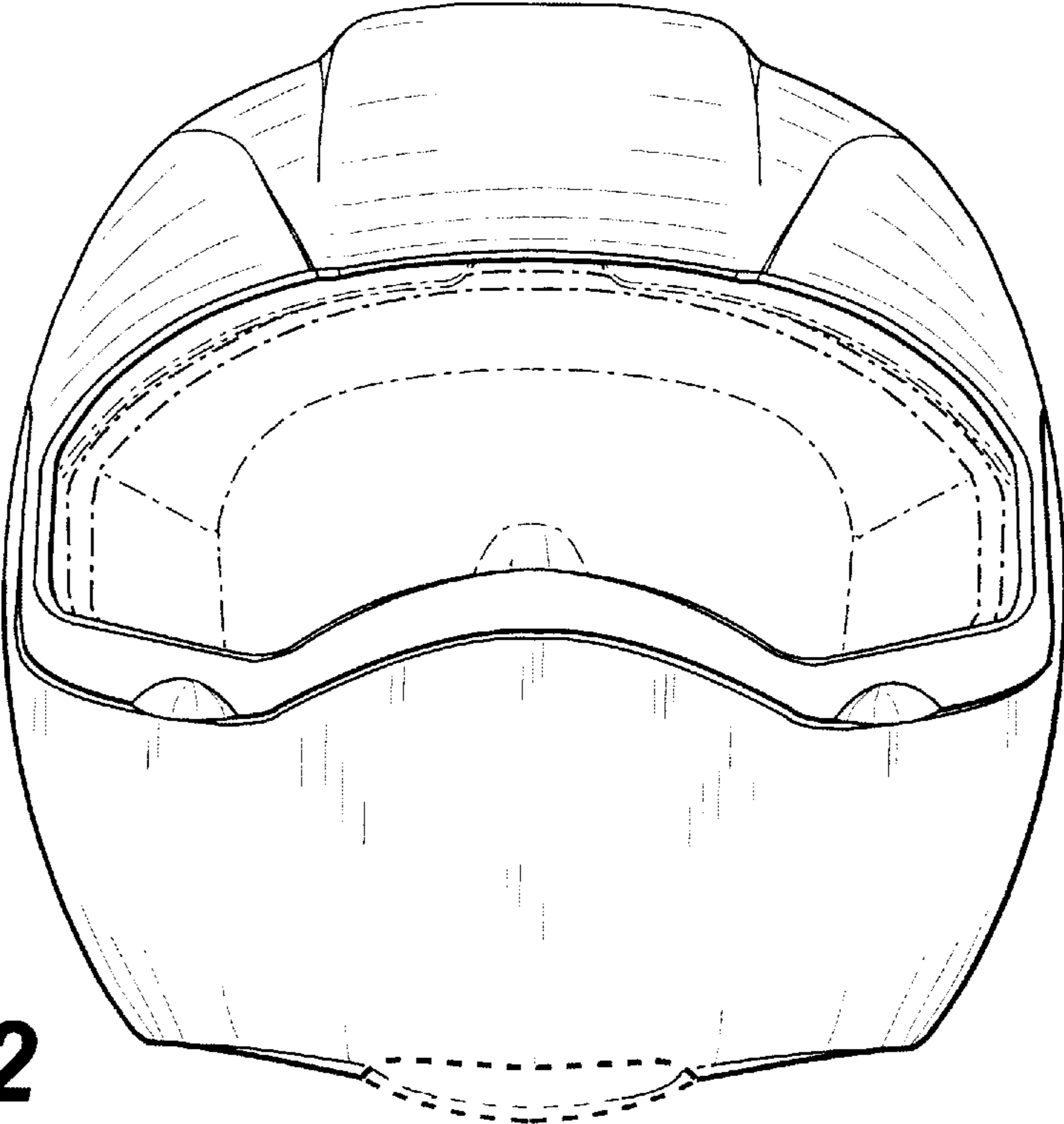

FIG. 2

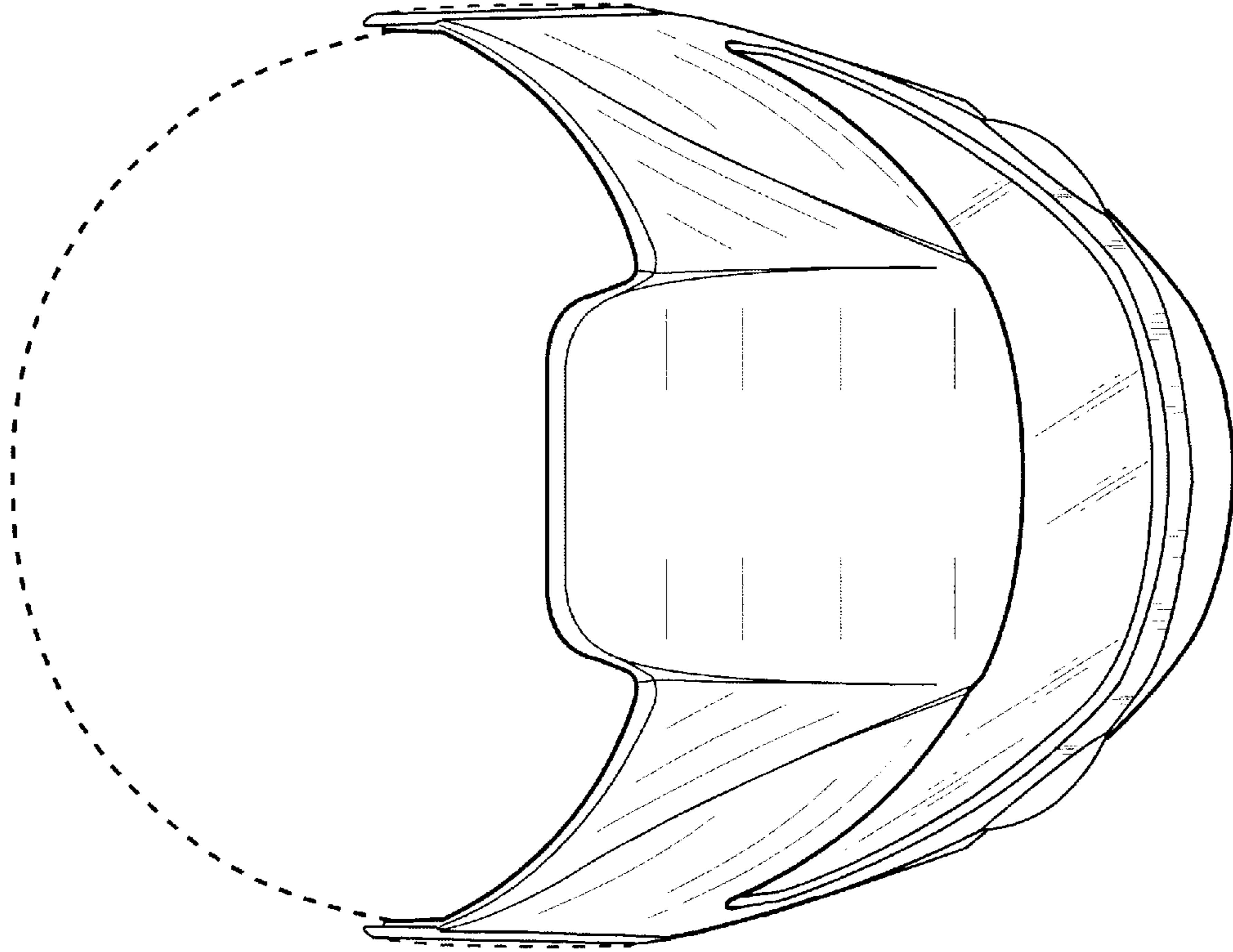

FIG. 3

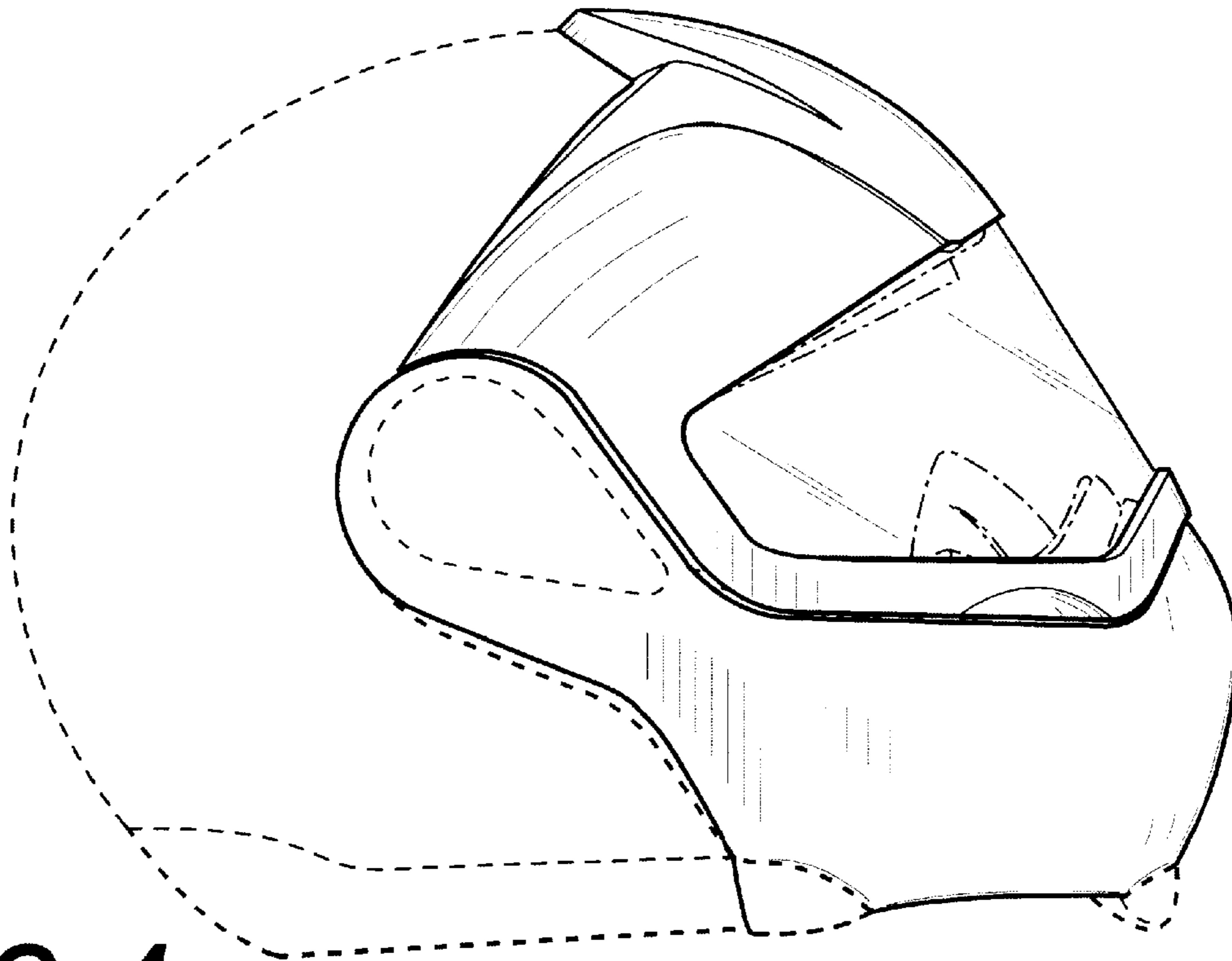

FIG. 4

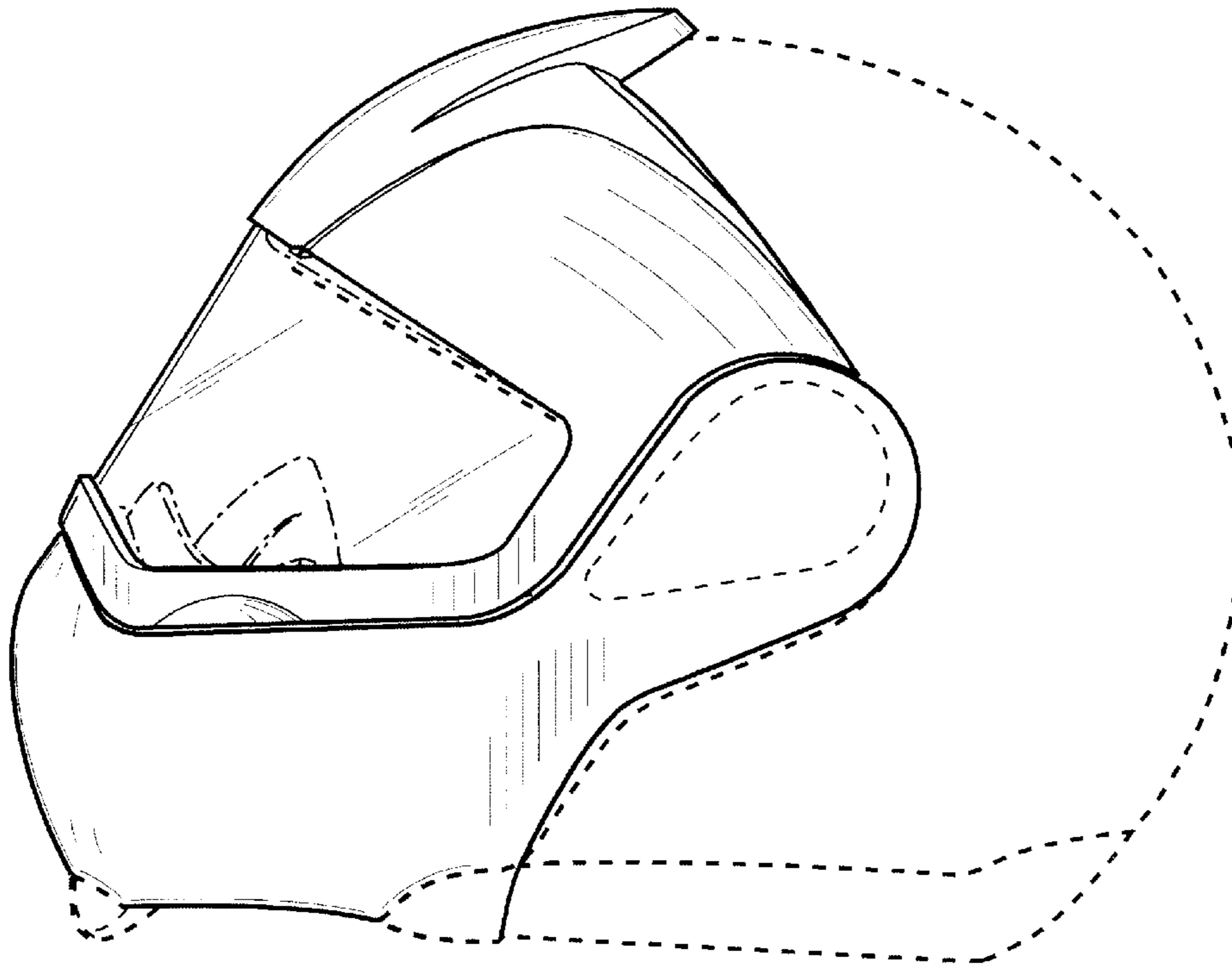

FIG. 5

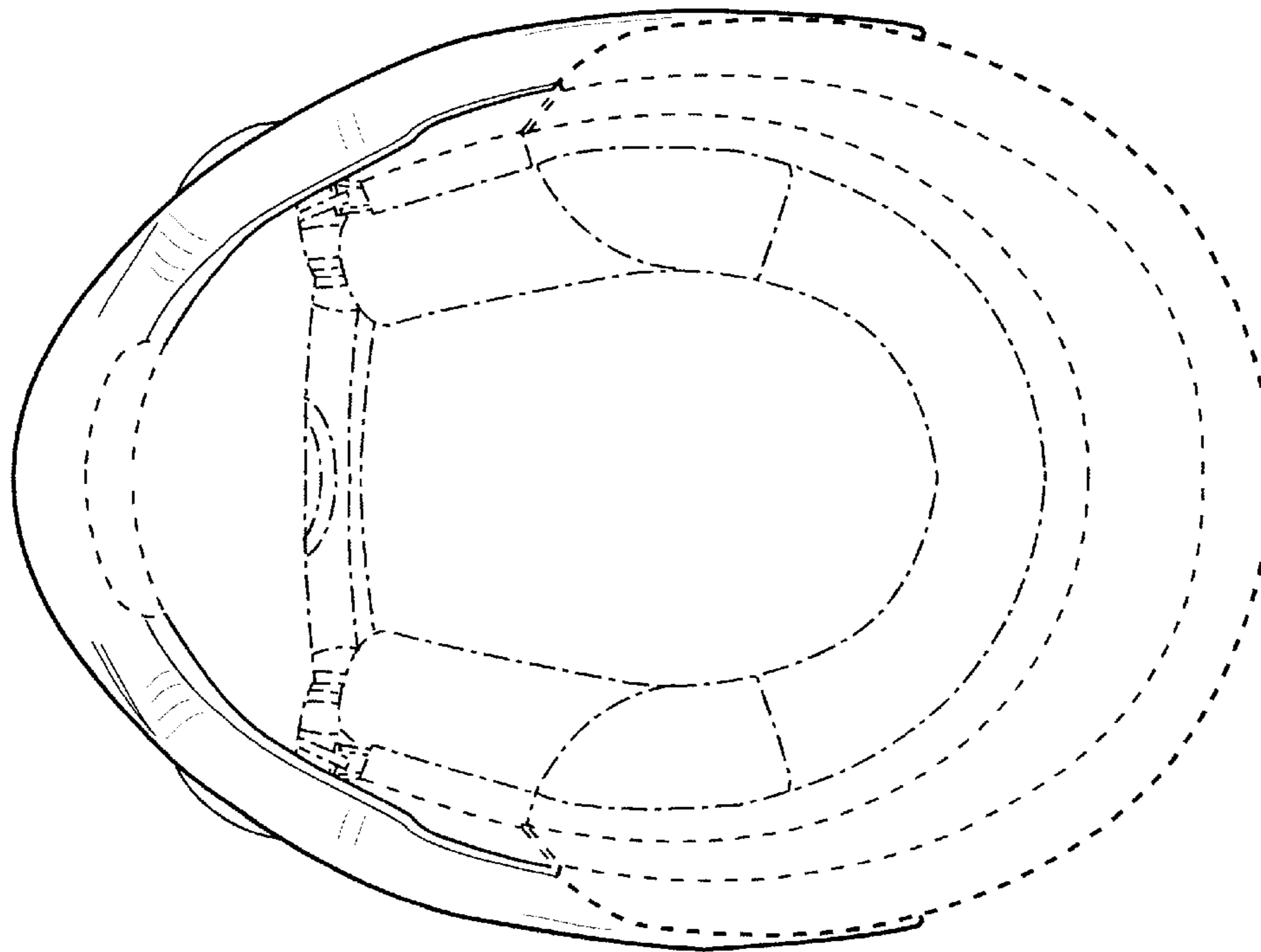

FIG. 6

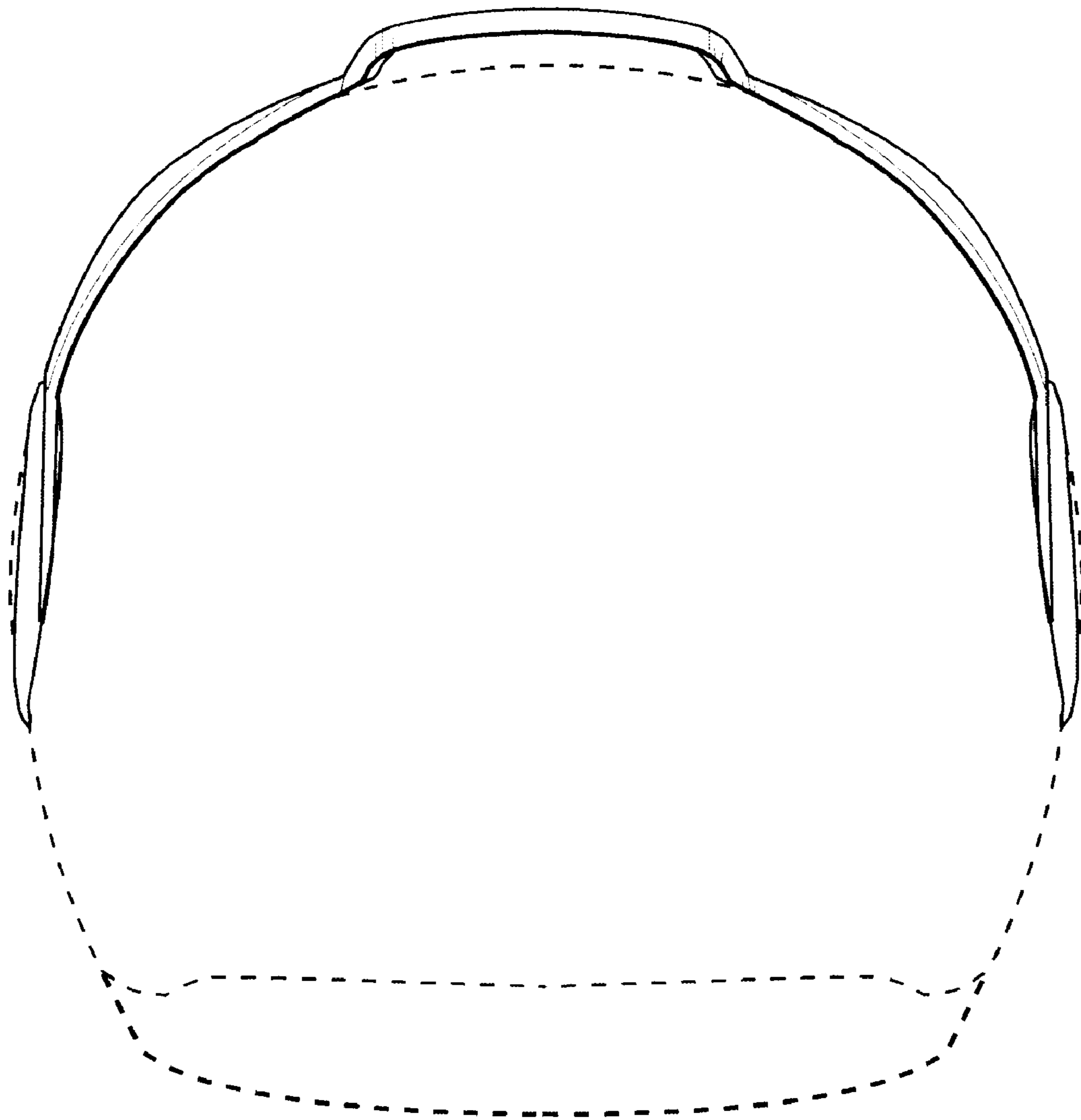

FIG. 7

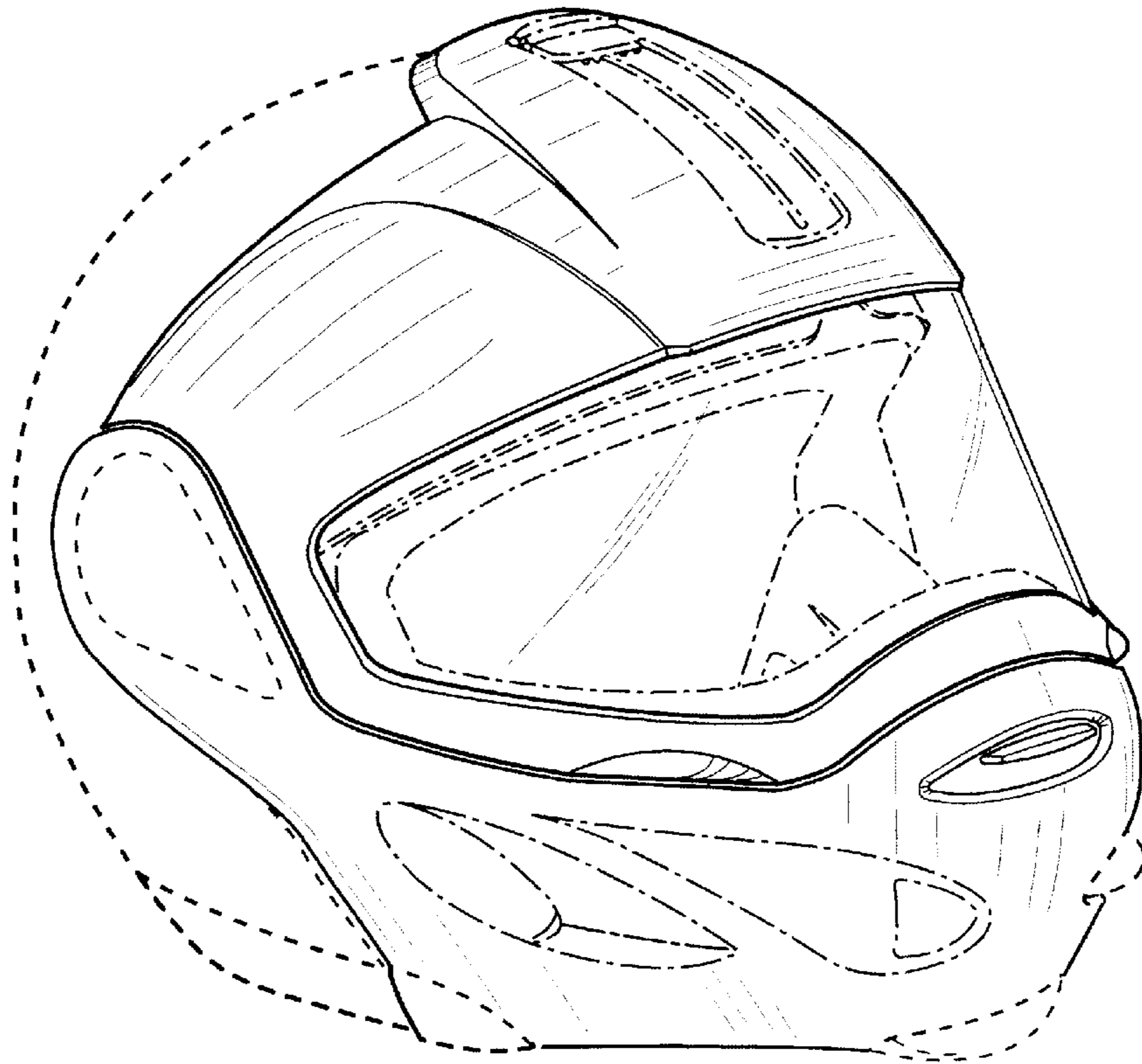

FIG. 8

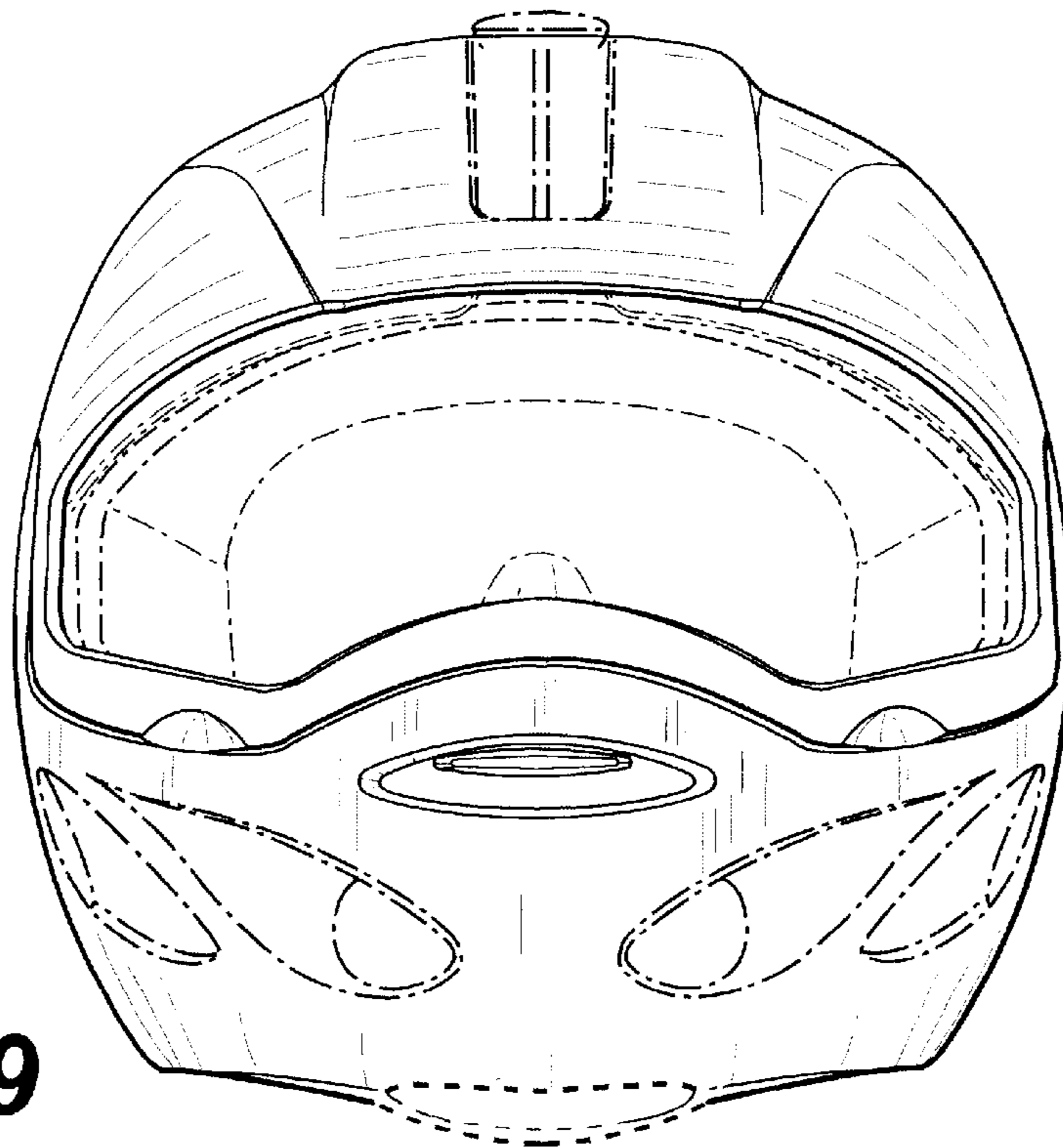

FIG. 9

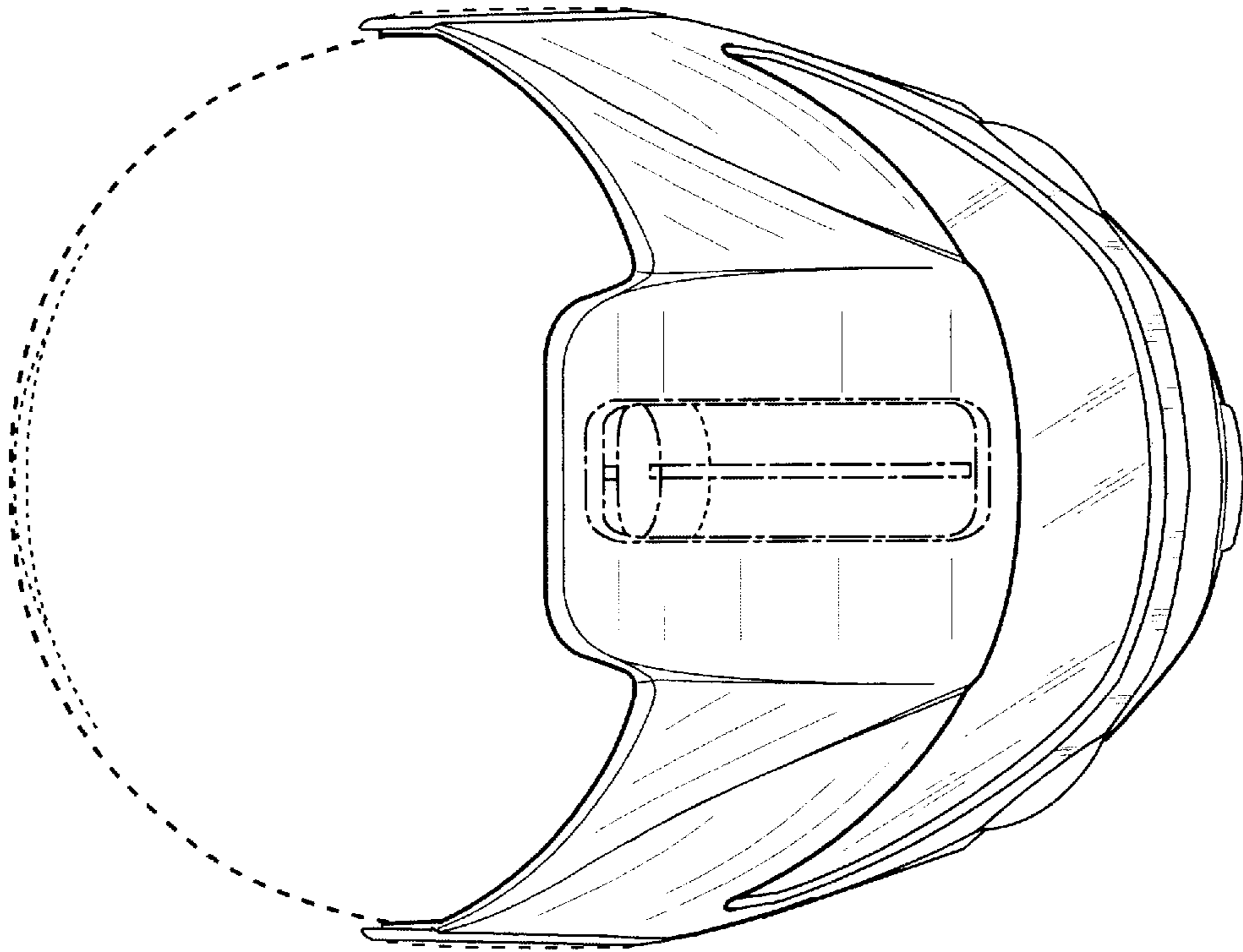

FIG. 10

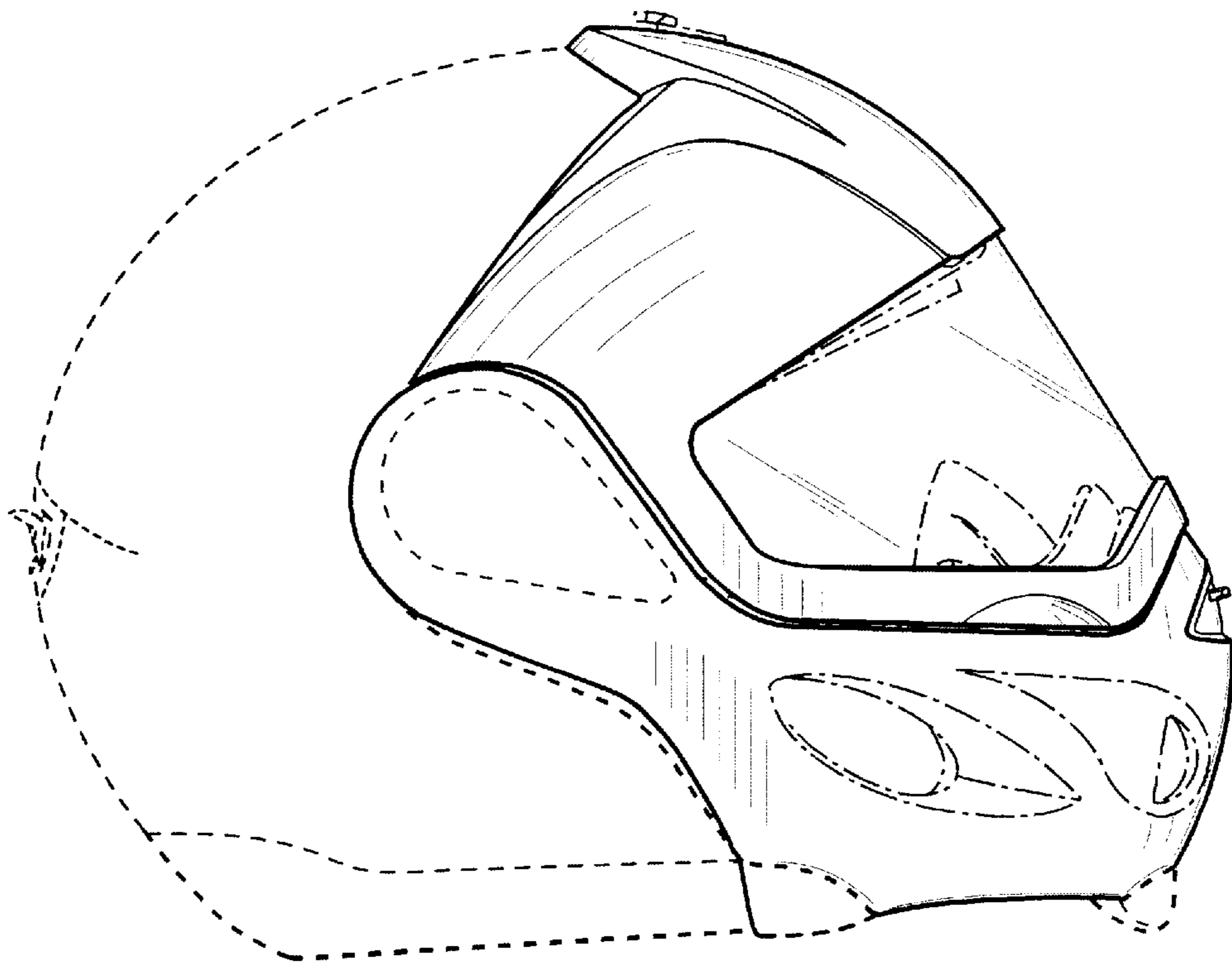

FIG. 11

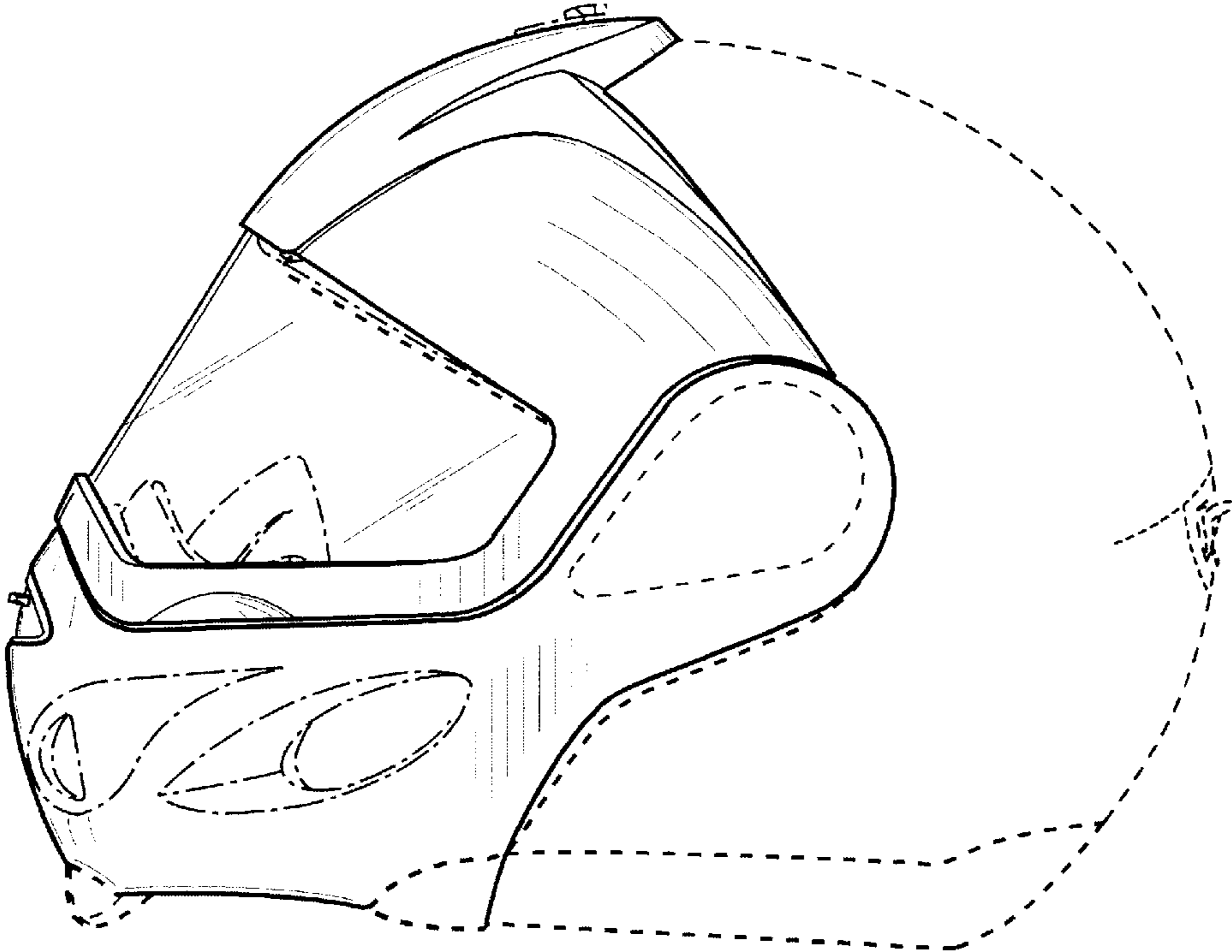

FIG. 12

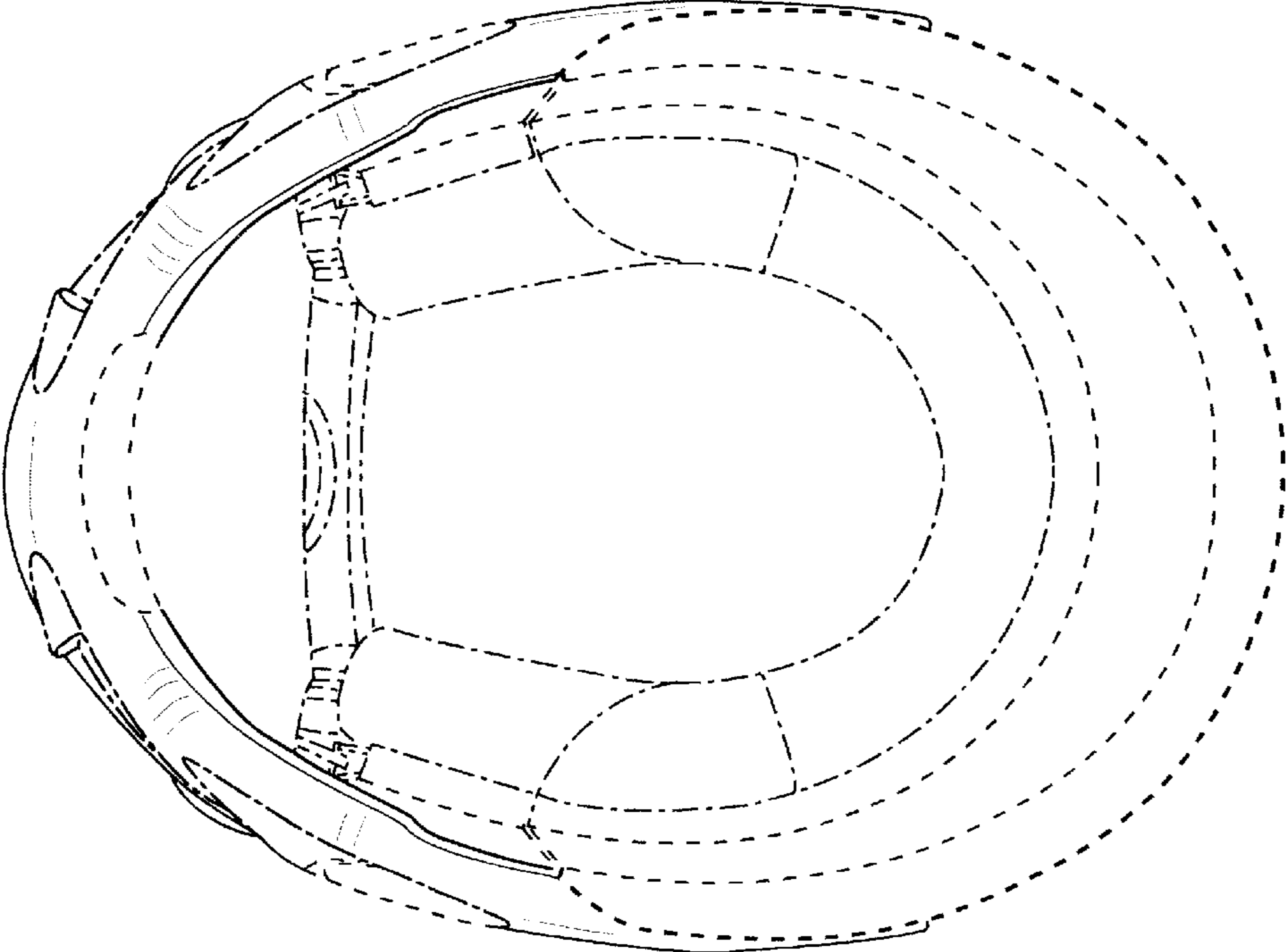

FIG. 13

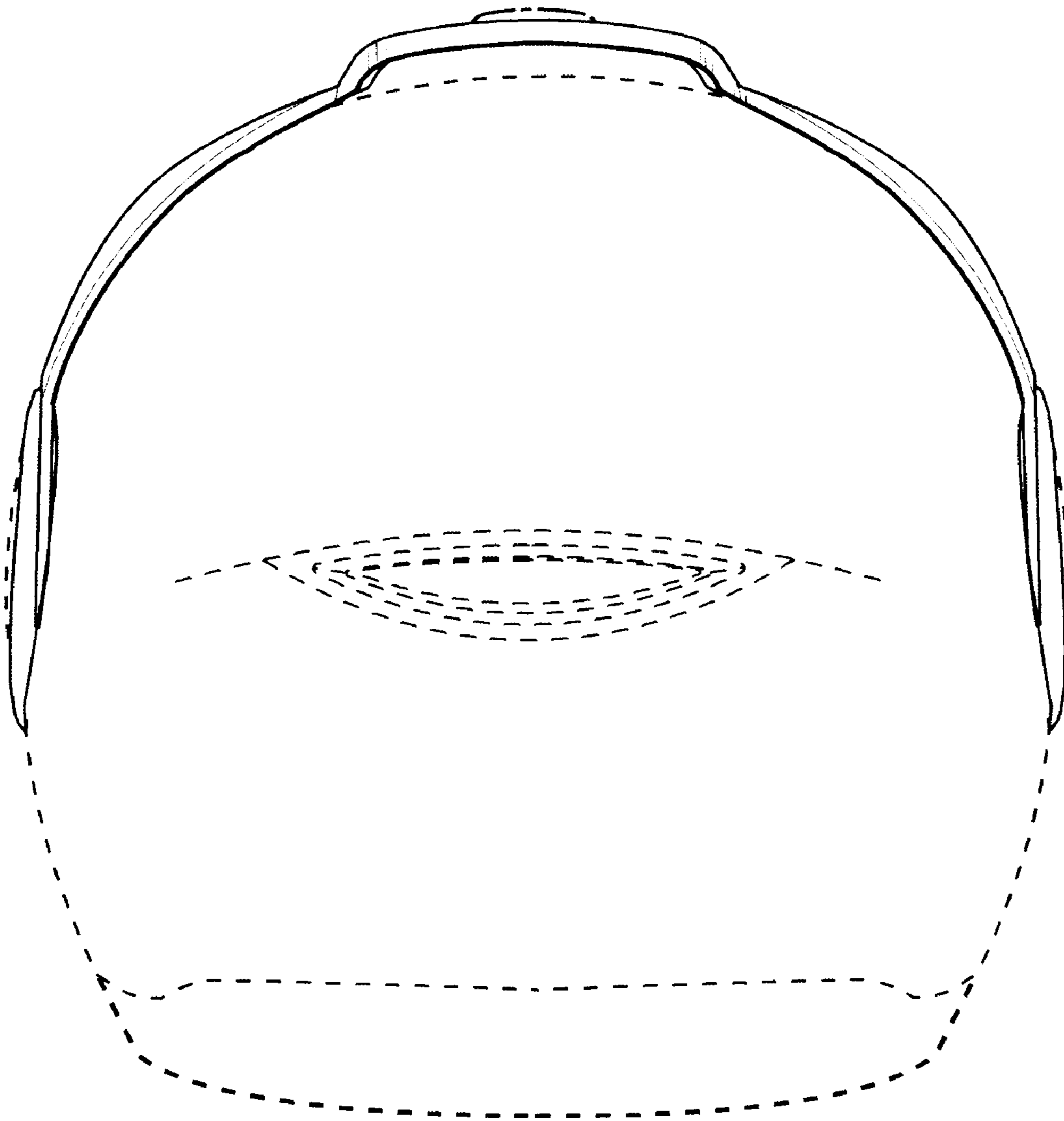

FIG. 14

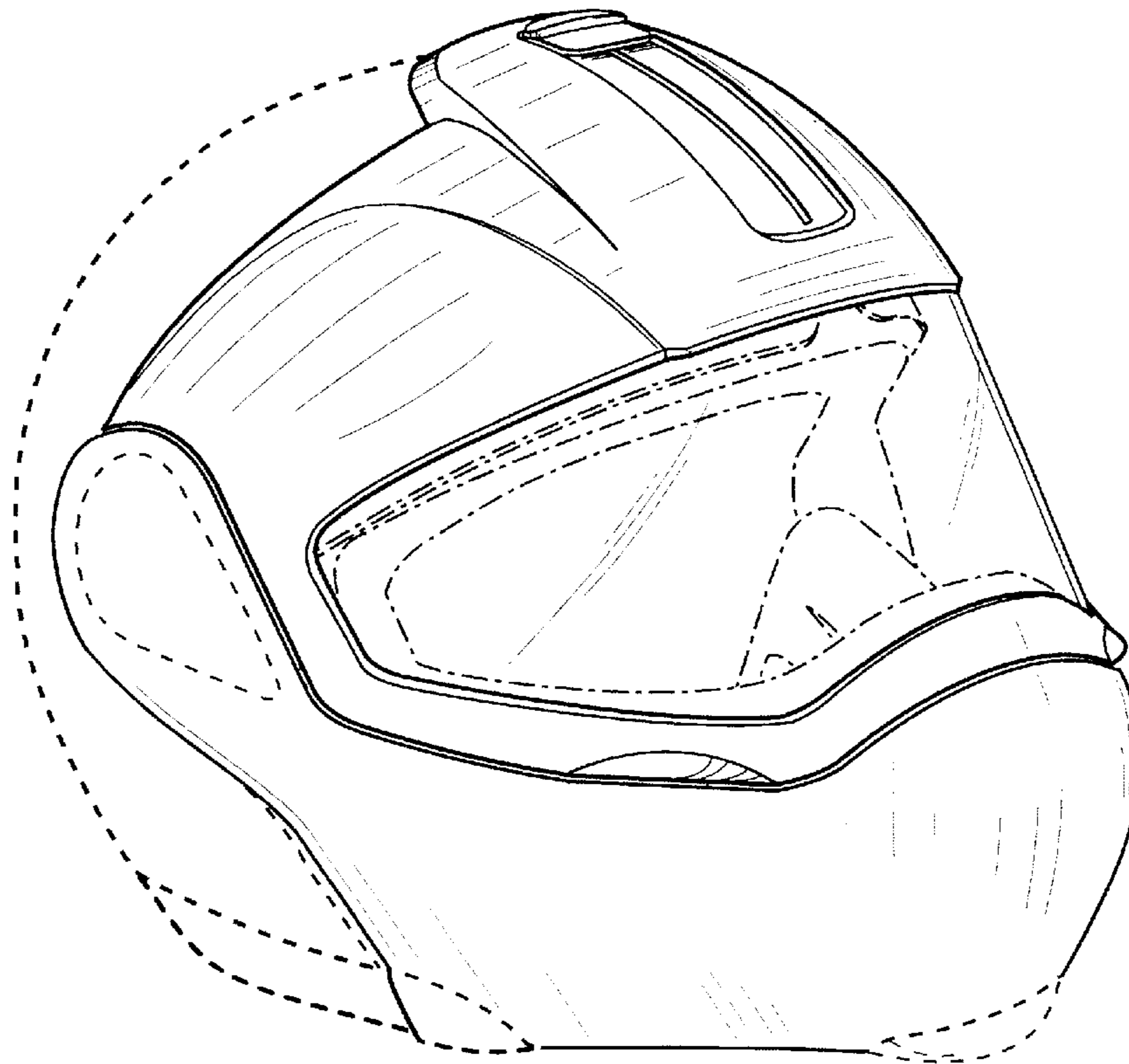

FIG. 15

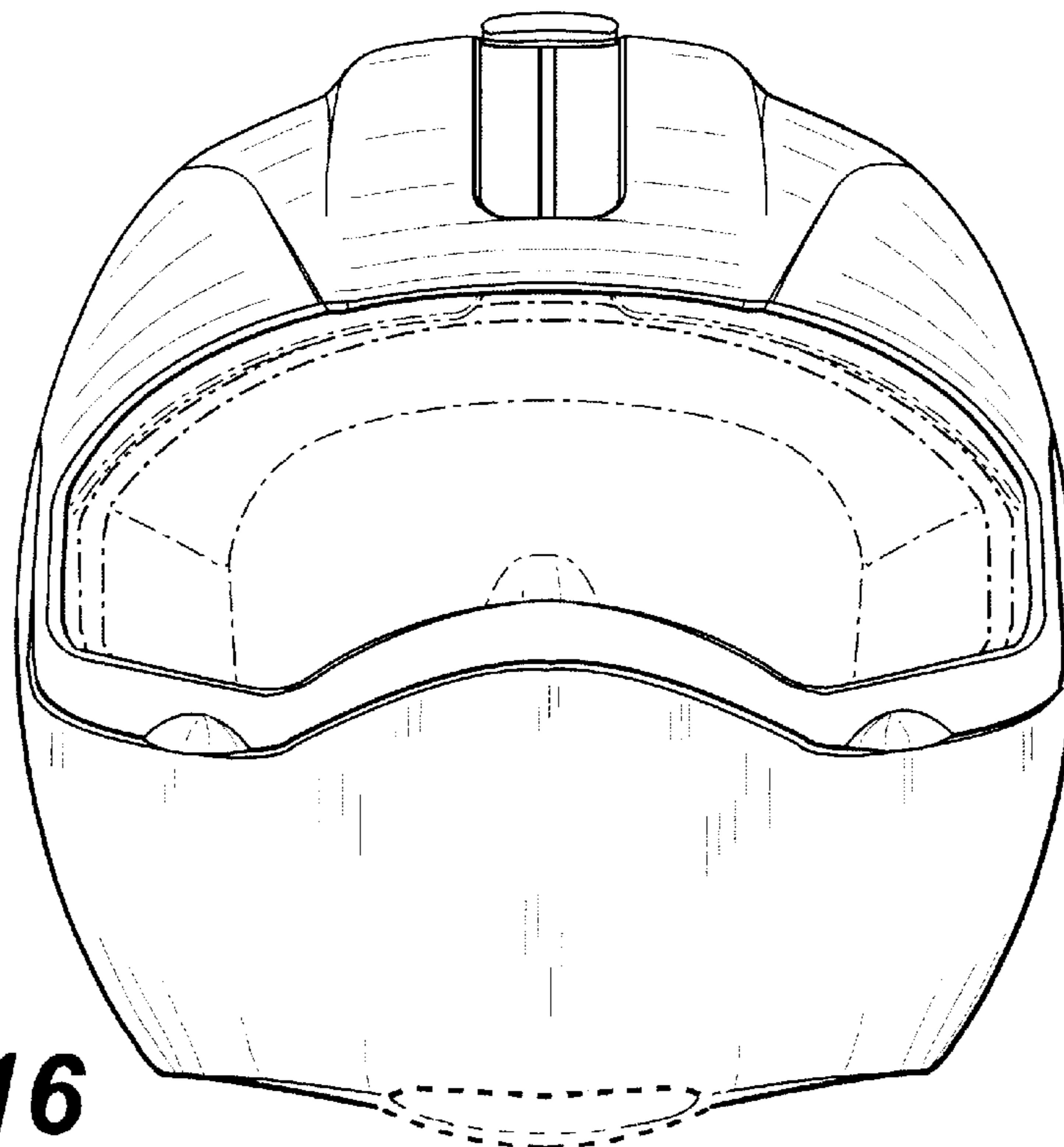

FIG. 16

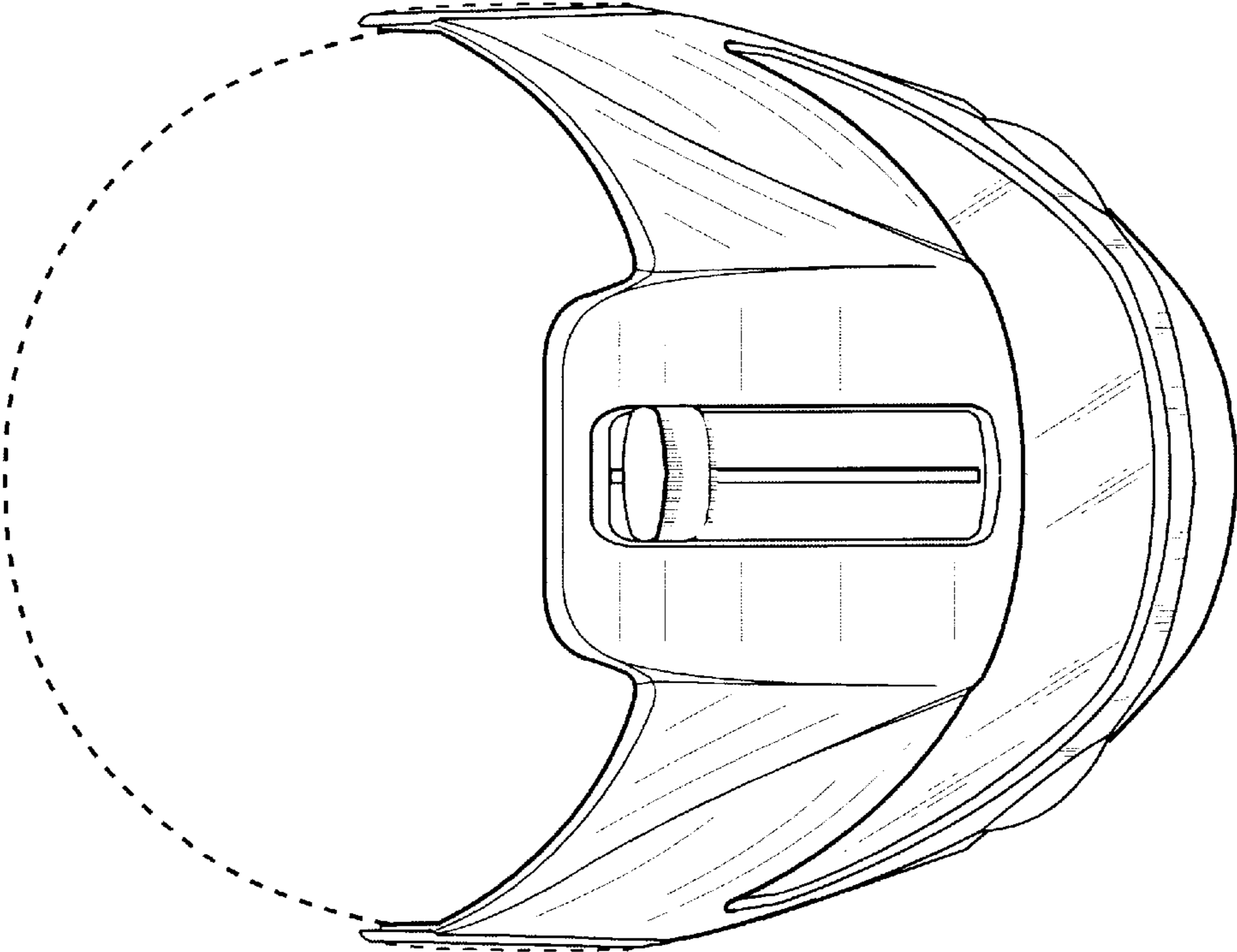

FIG. 17

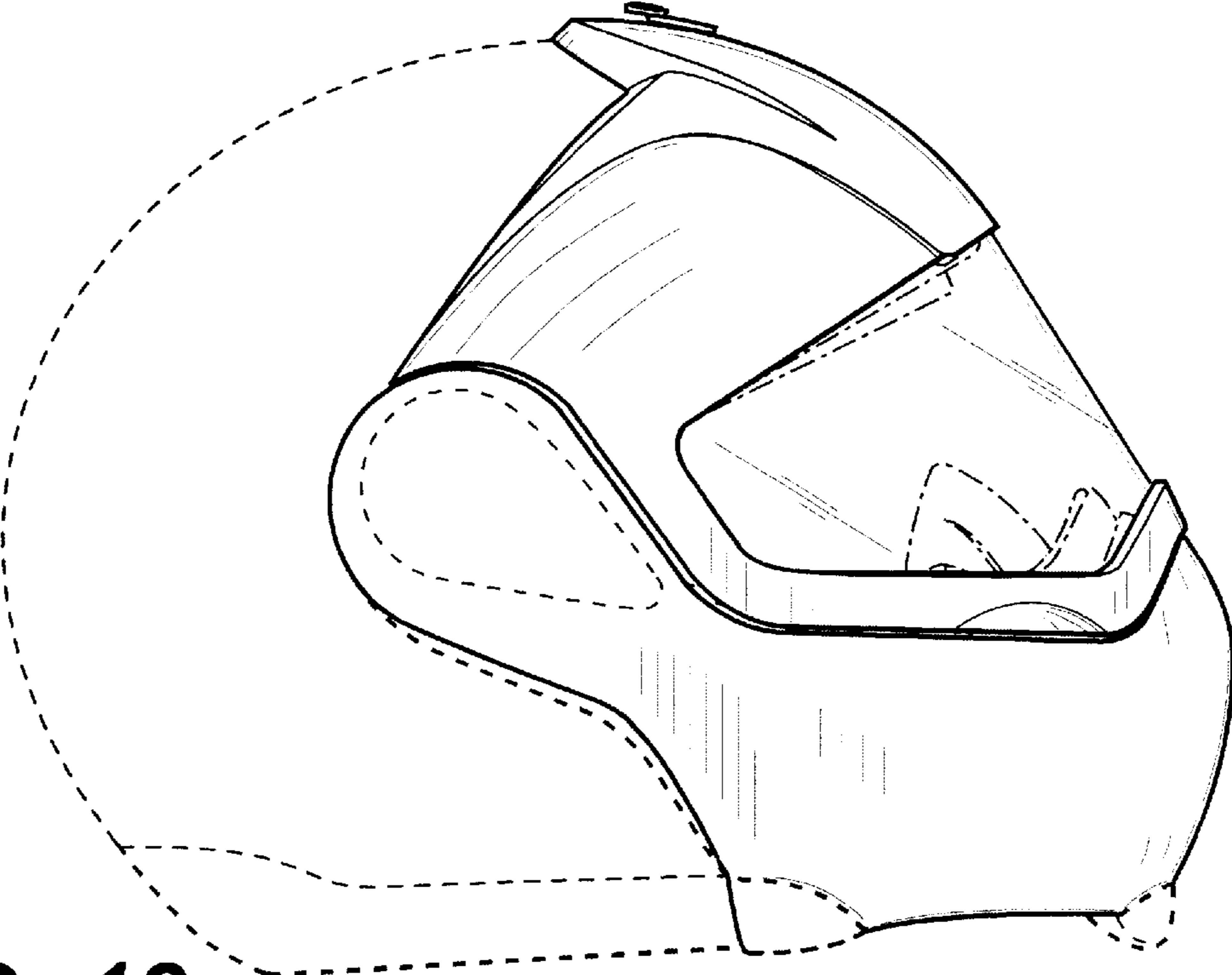

FIG. 18

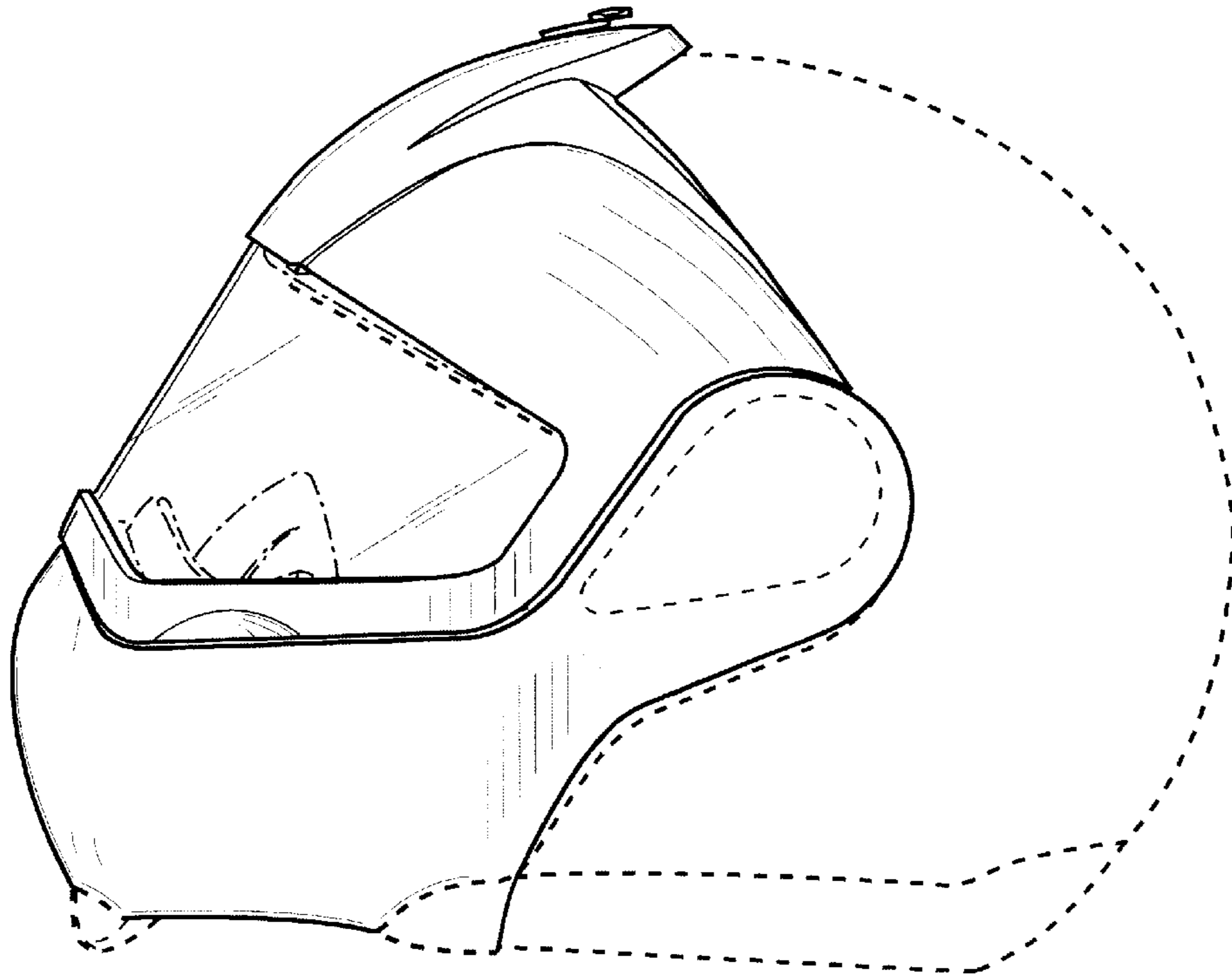

FIG. 19

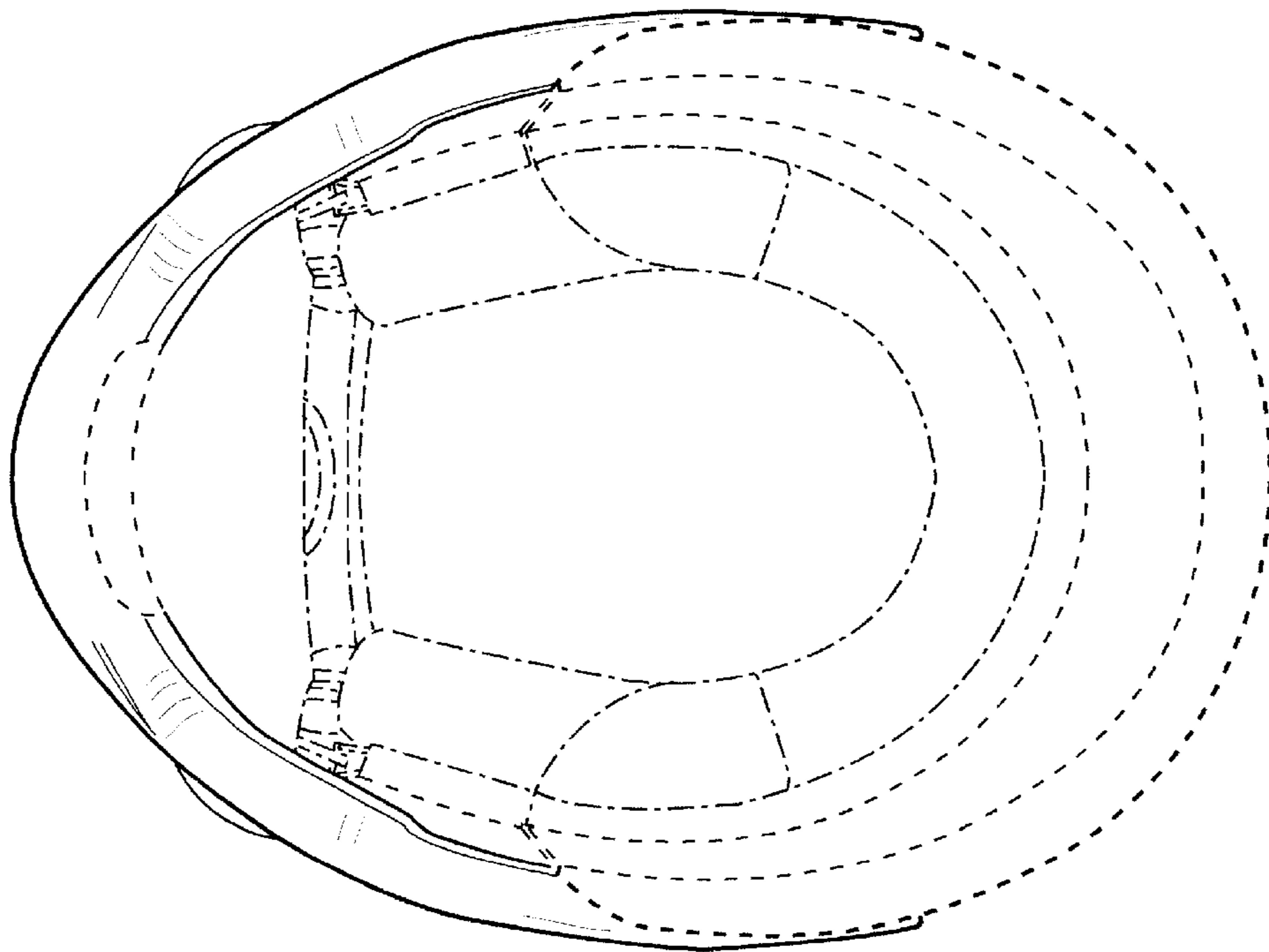

FIG. 20

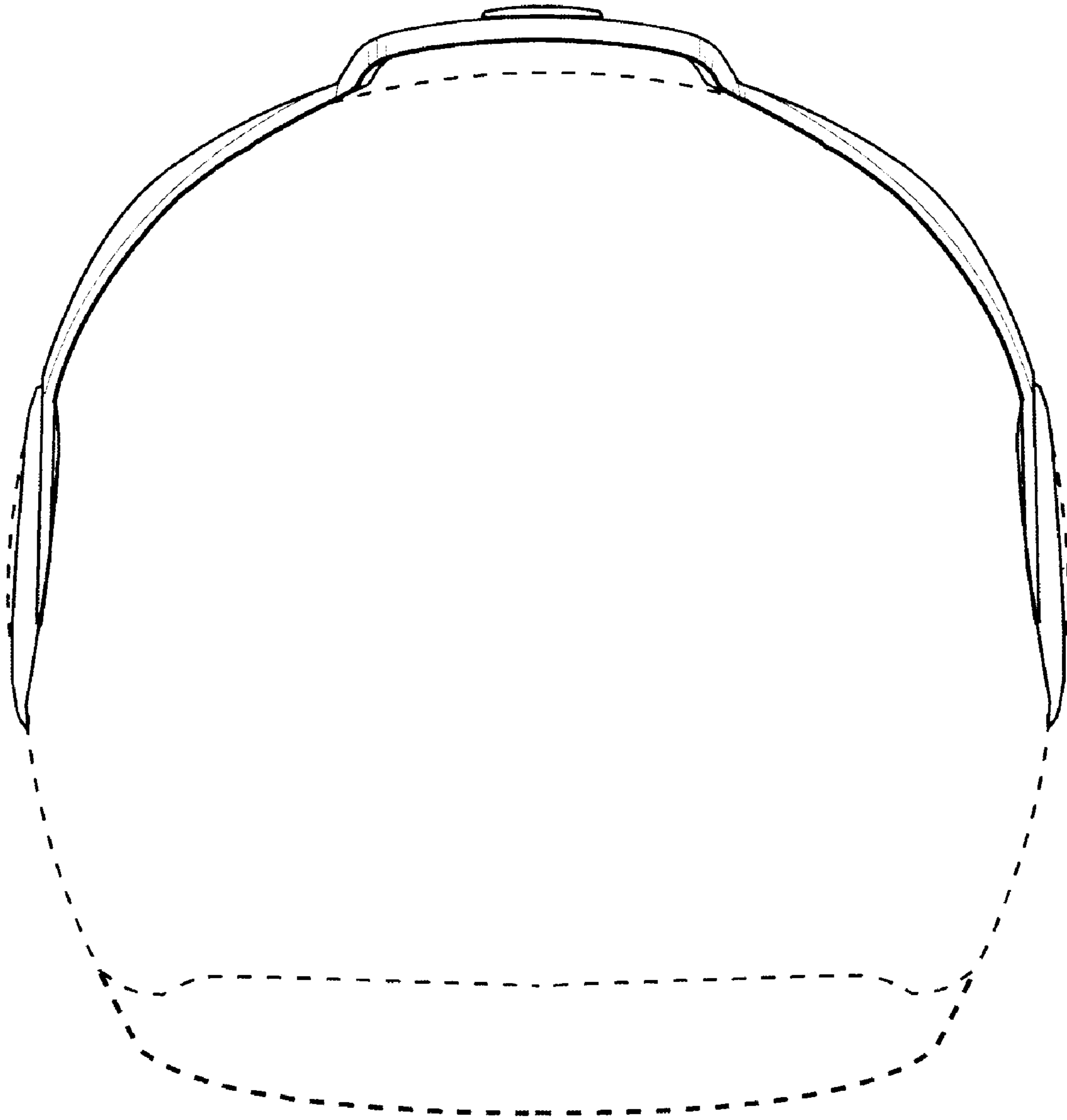

FIG. 21