

US00D497190S1

(12) **United States Design Patent**  
**Giannelli et al.**

(10) **Patent No.:** **US D497,190 S**  
(45) **Date of Patent:** **\*\* Oct. 12, 2004**

(54) **LATERAL RAISE EXERCISE MACHINE**

(75) Inventors: **Raymond Giannelli**, Franklin, MA (US); **Scott Lee**, Pomfret, CT (US)

(73) Assignee: **Cybex International, Inc.**, Medway, MA (US)

(\*\*) Term: **14 Years**

(21) Appl. No.: **29/176,526**

(22) Filed: **Feb. 21, 2003**

(51) **LOC (7) Cl.** ..... **21-02**

(52) **U.S. Cl.** ..... **D21/676; D21/675**

(58) **Field of Search** ..... **D21/673, 674, D21/675, 676; 482/94, 95, 96, 97, 98, 99, 100, 101, 102, 133**

(56) **References Cited**

**U.S. PATENT DOCUMENTS**

- 5,171,198 A \* 12/1992 Jones ..... 482/97
- 5,580,341 A \* 12/1996 Simonson ..... 482/100
- 5,897,467 A \* 4/1999 Habing et al. .... 482/100

- 6,142,917 A \* 11/2000 Giannelli et al. .... 482/100
- D440,610 S \* 4/2001 Webber et al. .... D21/675
- D440,611 S \* 4/2001 Batca et al. .... D21/676
- 6,254,516 B1 \* 7/2001 Giannelli et al. .... 482/100
- 6,394,937 B1 \* 5/2002 Voris ..... 482/139

\* cited by examiner

*Primary Examiner*—Philip S. Hyder

(74) *Attorney, Agent, or Firm*—Kudirka & Jobse, LLP

(57) **CLAIM**

The ornamental design for a lateral raise exercise machine, as shown.

**DESCRIPTION**

FIG. 1 is a front perspective view of the lateral raise exercise machine of the present invention; FIG. 2 is a front view thereof; FIG. 3 is a rear view thereof; FIG. 4 is a right side view thereof; FIG. 5 is a left side view thereof; and, FIG. 6 is a top view thereof.

**1 Claim, 6 Drawing Sheets**

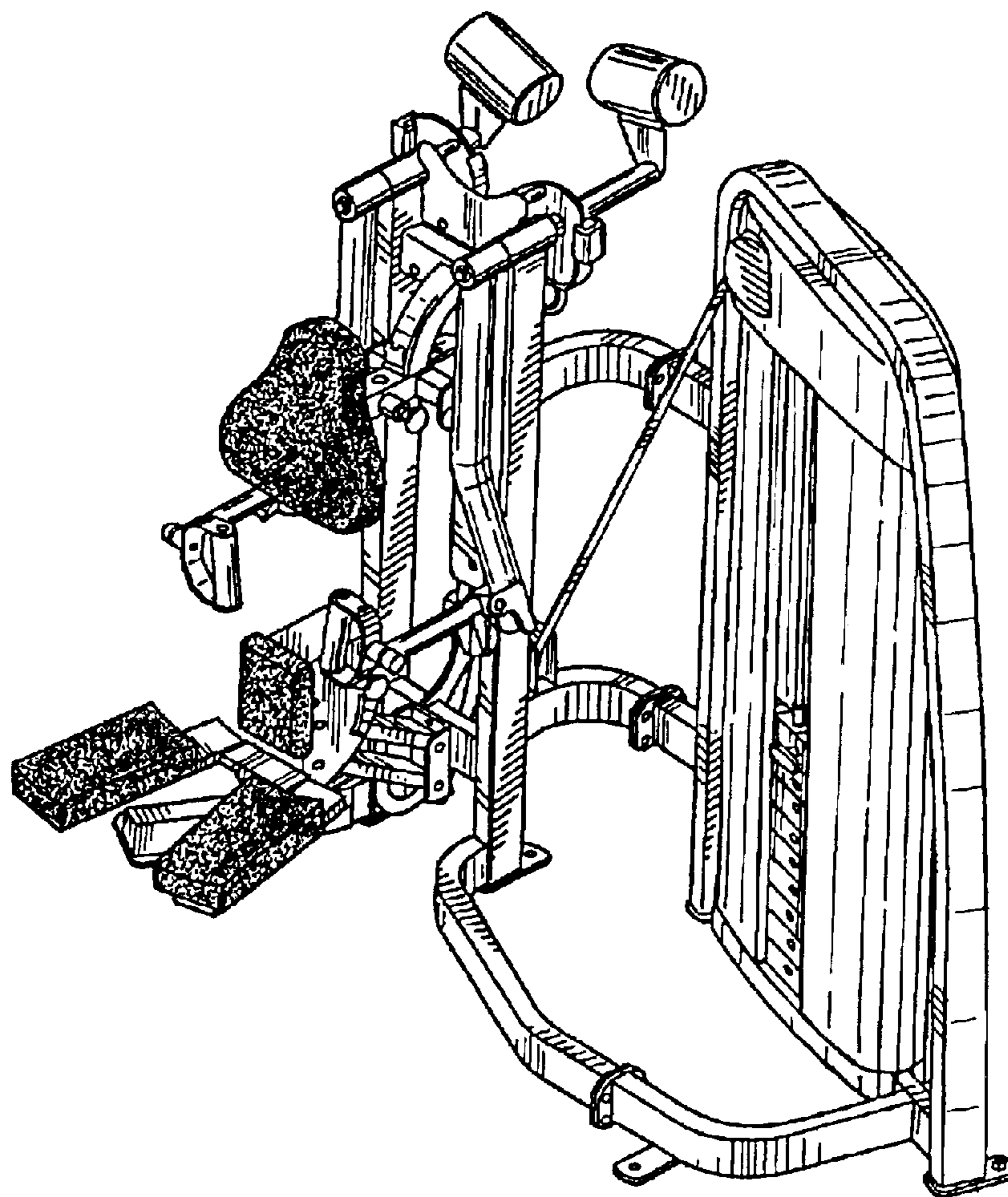

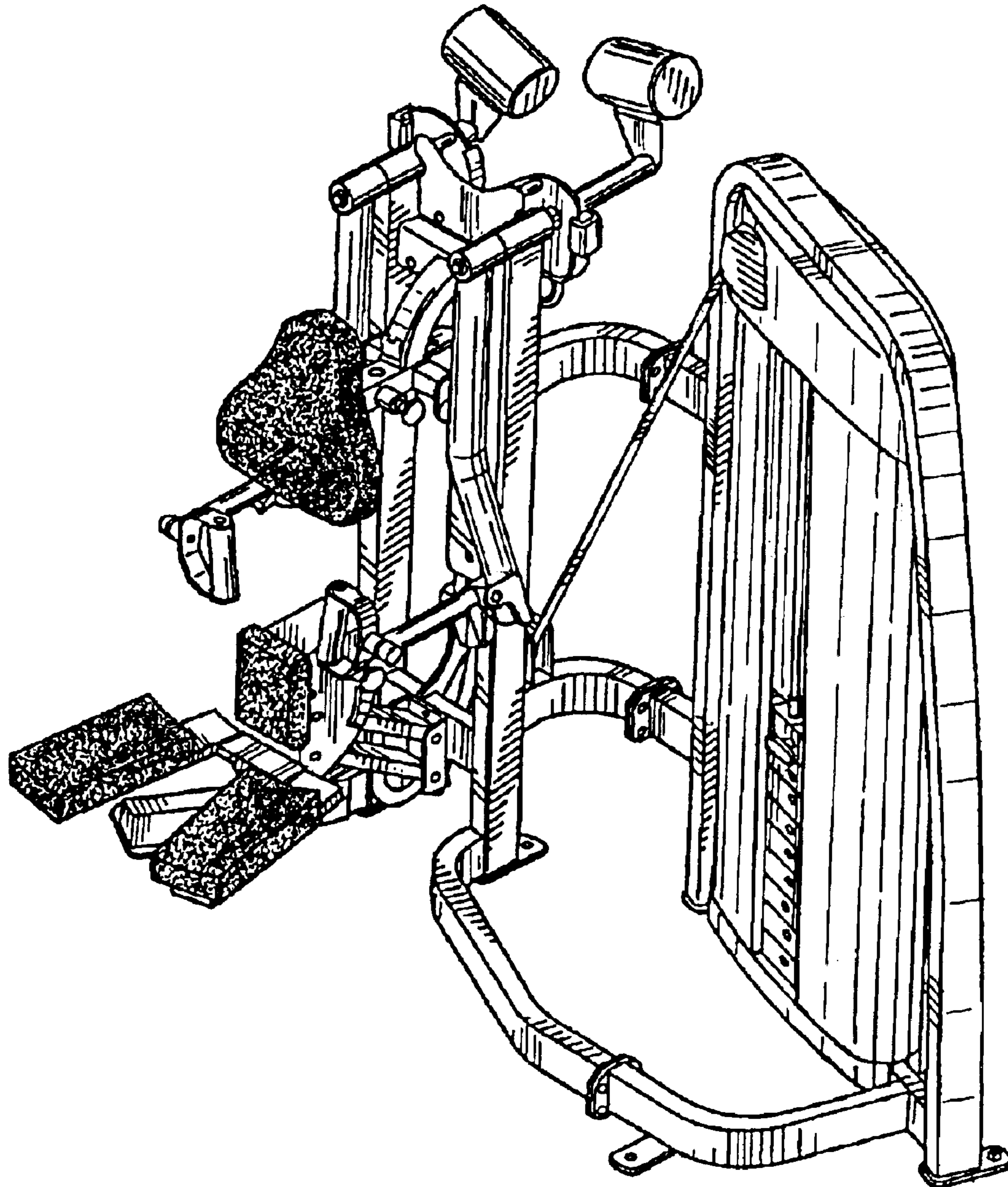

FIG. 1

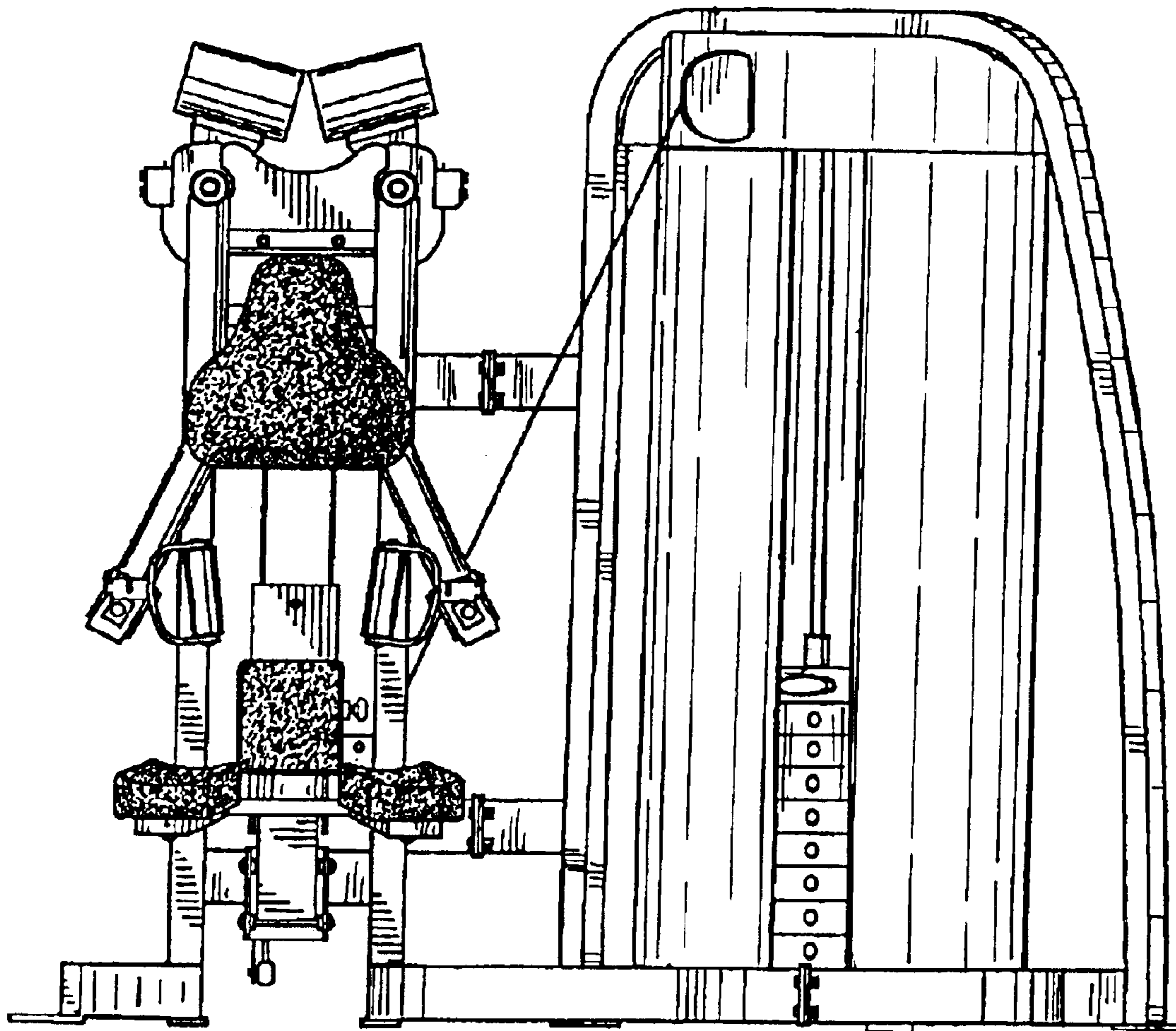

FIG. 2

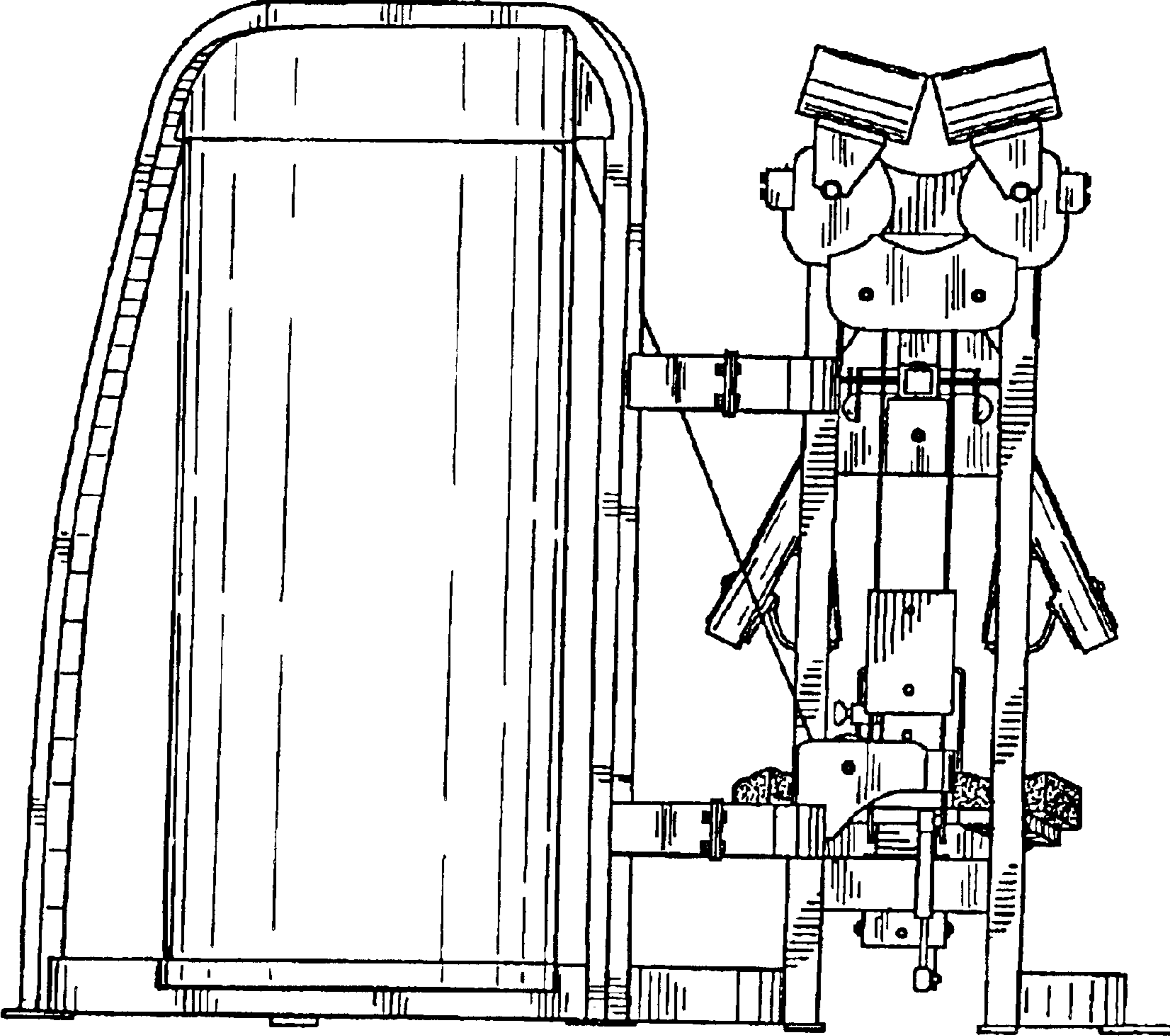

FIG. 3

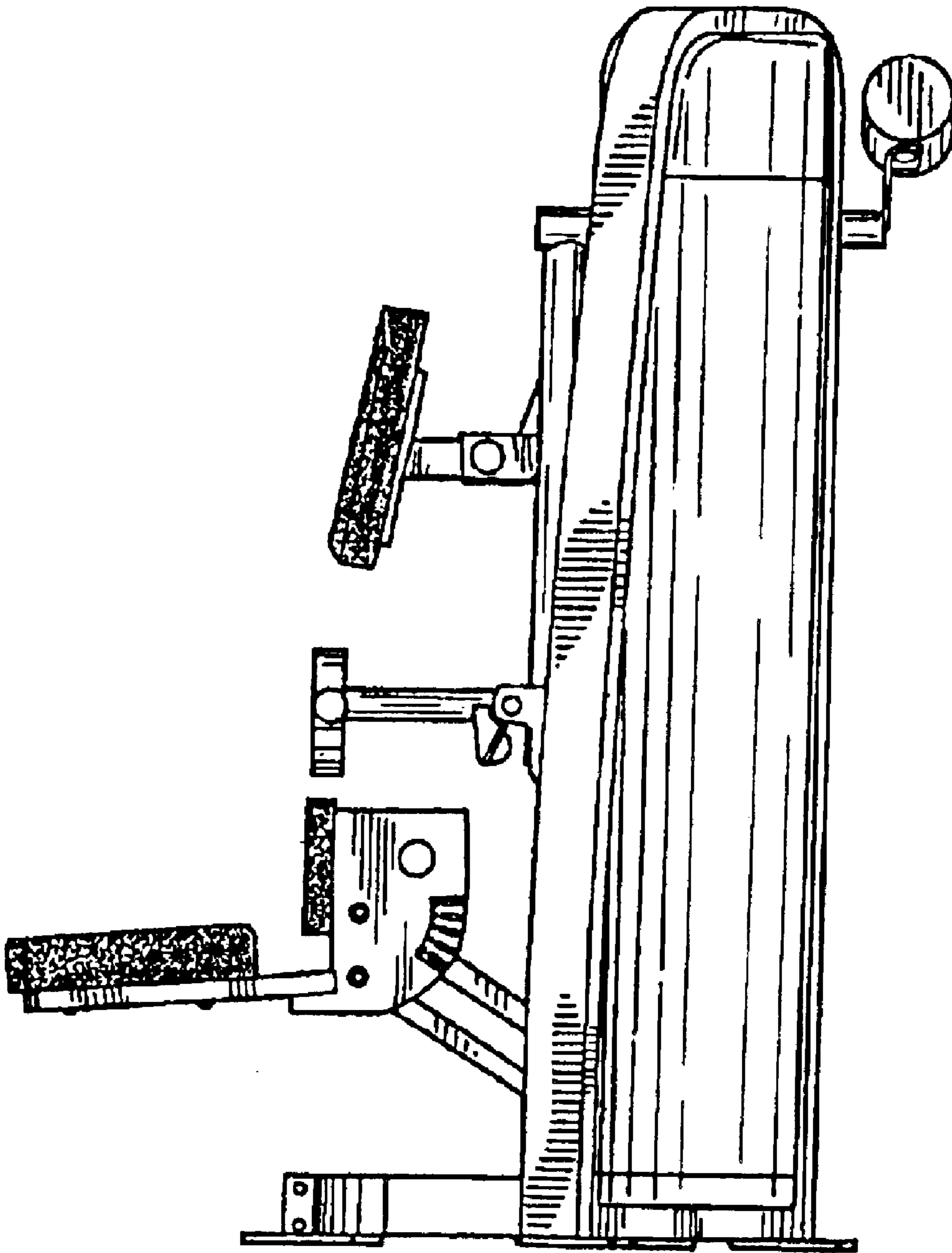

FIG. 4

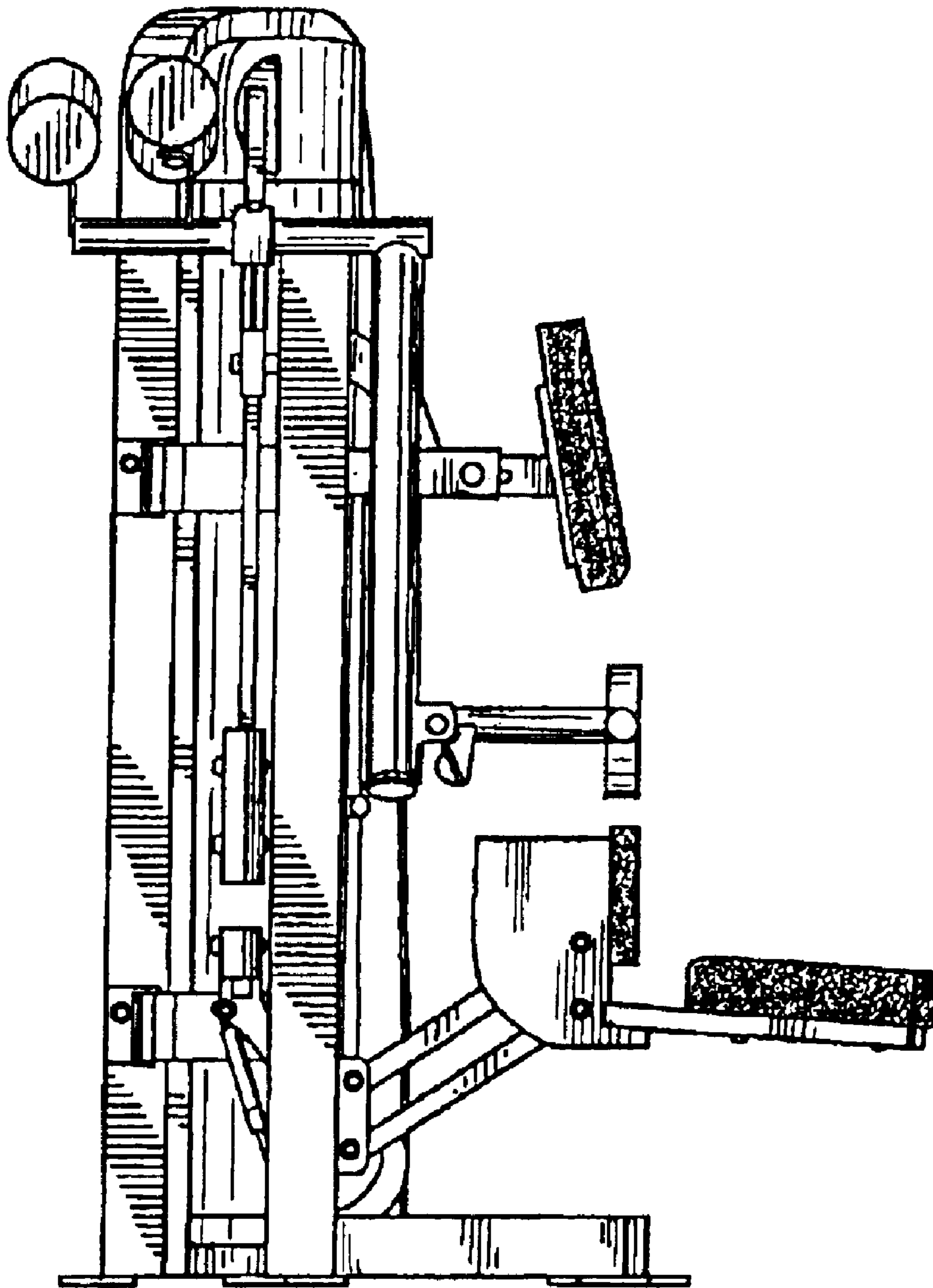

FIG. 5

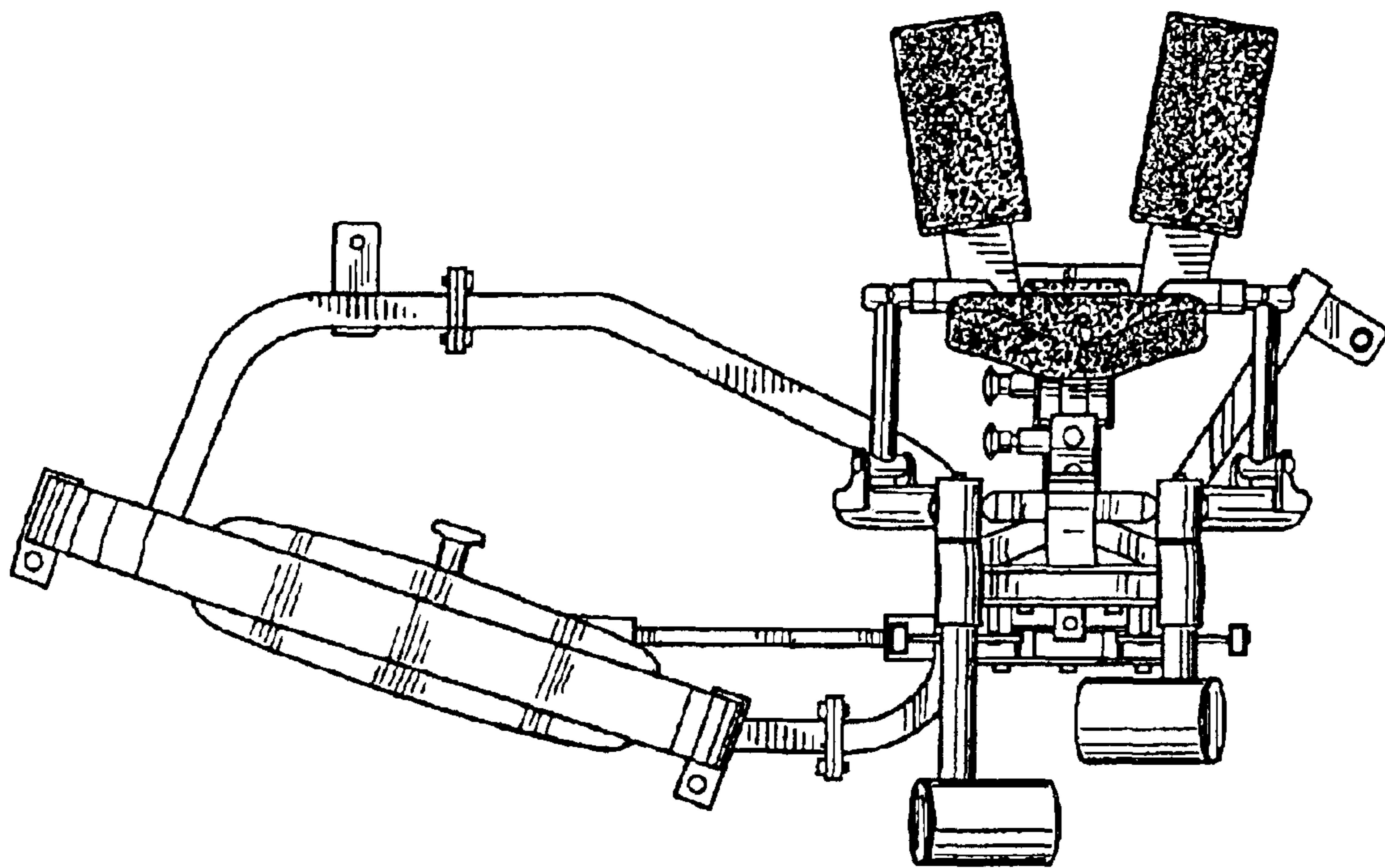

FIG. 6