

US00D497169S1

(12) **United States Design Patent**  
**Darity**

(10) **Patent No.:** **US D497,169 S**  
(45) **Date of Patent:** **\*\* Oct. 12, 2004**

(54) **MOWER BLADE**

(75) **Inventor:** **Hershel Lynn Darity**, P.O. Box 24,  
Swink, OK (US) 74761

(73) **Assignee:** **Hershel Lynn Darity**, Swink, OK (US)

(\*\*) **Term:** **14 Years**

(21) **Appl. No.:** **29/161,805**

(22) **Filed:** **Jun. 4, 2002**

(51) **LOC (7) Cl.** ..... **15-03**

(52) **U.S. Cl.** ..... **D15/17**

(58) **Field of Search** ..... D15/14-18, 28,  
D15/32; 30/347, 276, 390; 56/295, 255,  
289, 13.4, 17.5

(56) **References Cited**

**U.S. PATENT DOCUMENTS**

2,963,844 A	12/1960	Engler	
3,103,093 A	9/1963	House	
3,636,685 A *	1/1972	Speckman	56/295
4,594,843 A	6/1986	Andersson et al.	
D289,524 S *	4/1987	Andersson et al.	D15/17
4,922,698 A	5/1990	Taylor	
5,094,065 A *	3/1992	Azbell	56/255
5,271,212 A	12/1993	Anderson	
5,284,006 A *	2/1994	Sheldon	56/255
D357,691 S *	4/1995	Bryant	D15/17
5,438,819 A *	8/1995	Dallman	56/295
5,442,902 A *	8/1995	Mosley et al.	56/17.5

5,867,973 A 2/1999 Geier  
6,182,430 B1 \* 2/2001 Blarek et al. .... 56/295  
D450,066 S \* 11/2001 Monesmith ..... D15/17

\* cited by examiner

*Primary Examiner*—Mitchell Siegel

(74) *Attorney, Agent, or Firm*—Dunlap, Coddling & Rogers  
P.C.

(57) **CLAIM**

The ornamental design for a mower blade, as shown and described.

**DESCRIPTION**

FIG. 1 is a pictorial representation of a mower blade showing my new design, a mower, shown in phantom, for illustrative purposes only, having the mower blade connected thereto.

FIG. 2 is a front elevational view thereof, a rear elevational view being a mirror image thereof;

FIG. 3 is an elevational view of one end thereof, an opposed end being a mirror image thereof;

FIG. 4 is a top plan view thereof; and

FIG. 5 is a bottom plan view thereof.

FIG. 6 is a front elevational view of another embodiment thereof, a rear elevational view being a mirror image thereof;

FIG. 7 is an elevational view of one end thereof, an opposed end being a mirror image thereof;

FIG. 8 is a top plan view thereof; and,

FIG. 9 is a bottom plan view thereof.

**1 Claim, 2 Drawing Sheets**

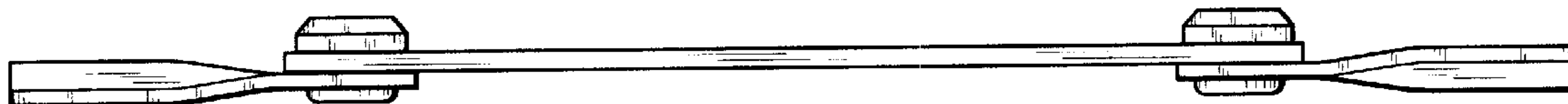

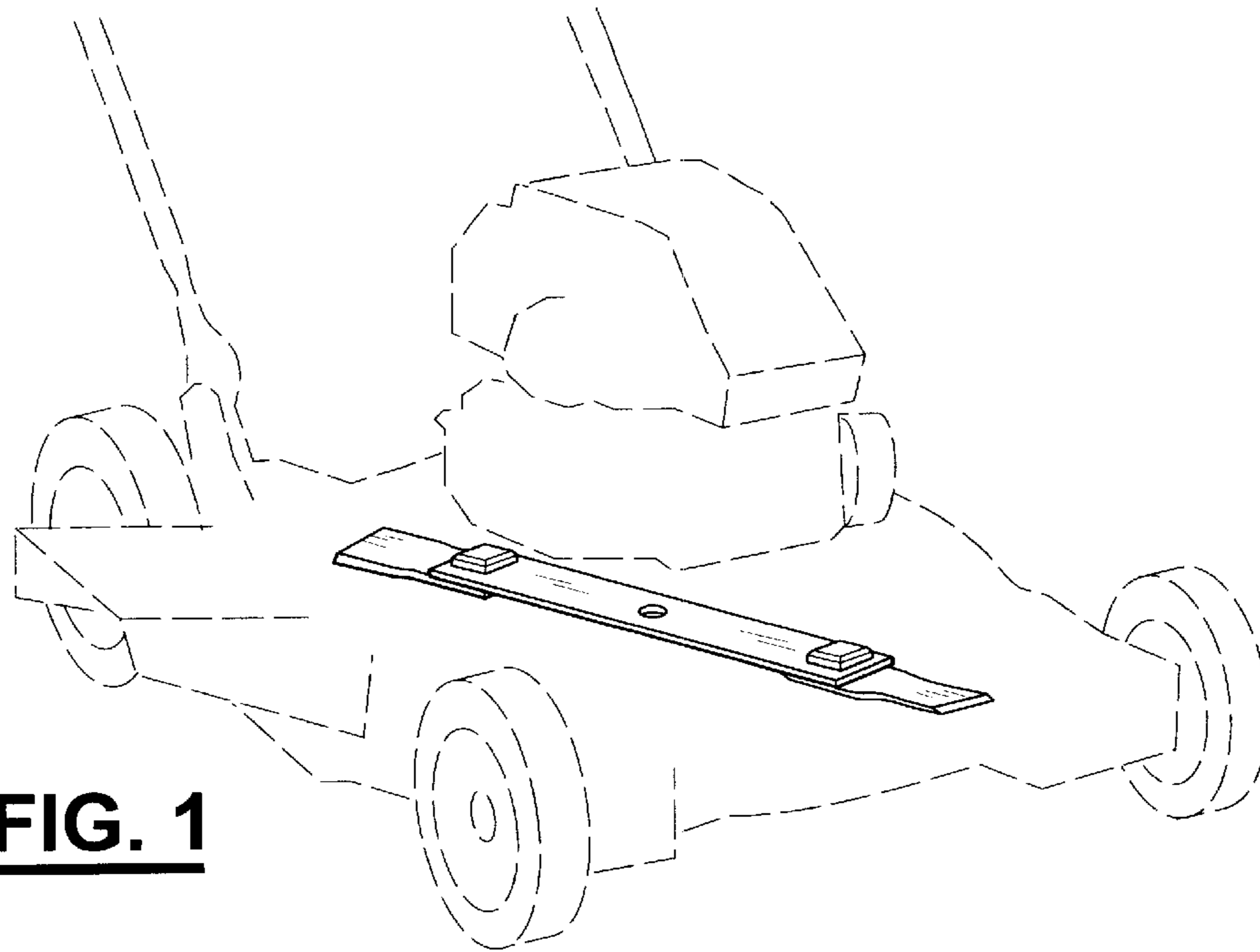

**FIG. 1**

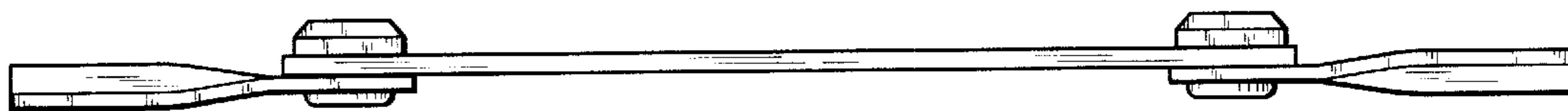

**FIG. 2**



**FIG. 3**

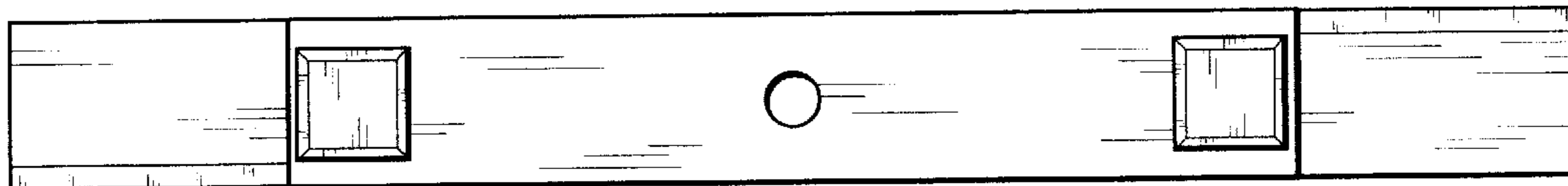

**FIG. 4**

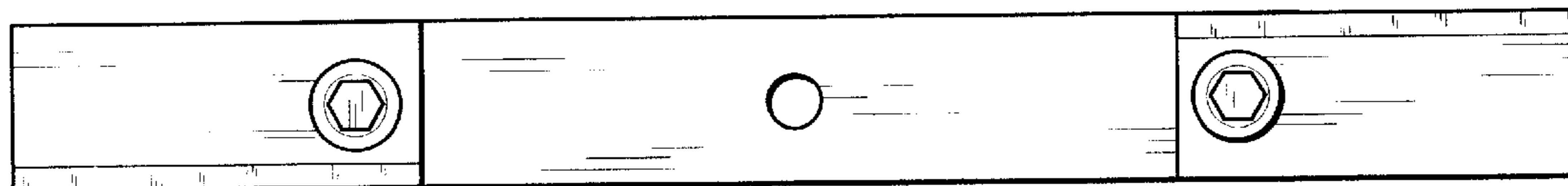

**FIG. 5**

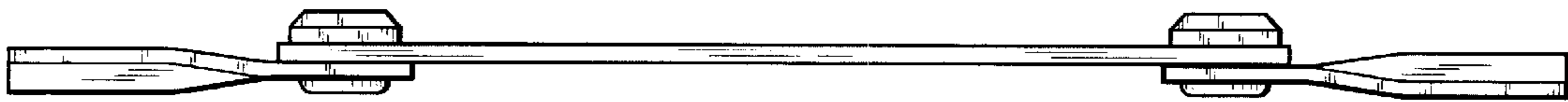

**FIG. 6**



**FIG. 7**

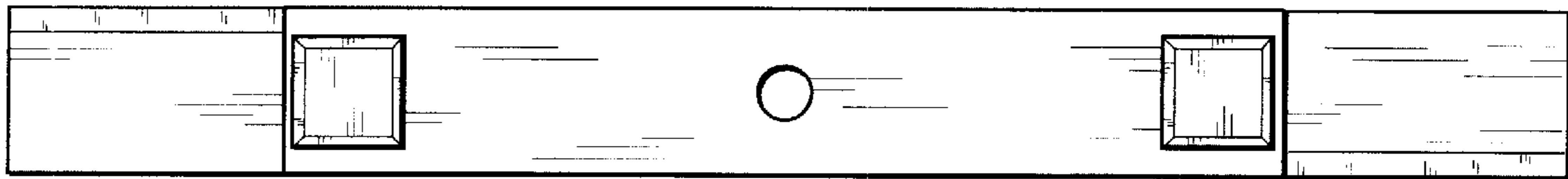

**FIG. 8**

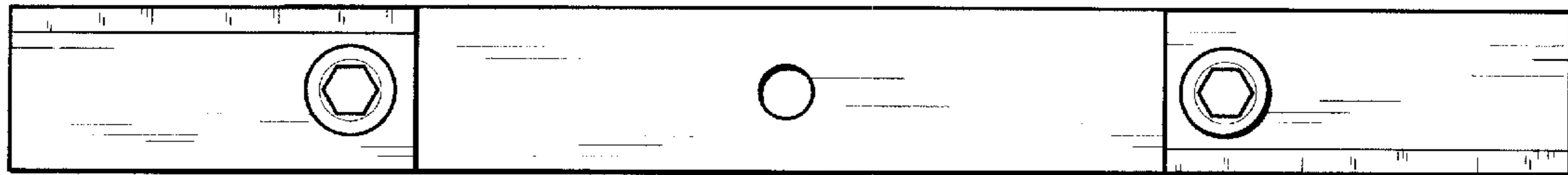

**FIG. 9**

UNITED STATES PATENT AND TRADEMARK OFFICE  
**CERTIFICATE OF CORRECTION**

PATENT NO. : Des. 497,169 S  
APPLICATION NO. : 29/161805  
DATED : October 12, 2004  
INVENTOR(S) : Hershel Lynn Darity

Page 1 of 2

It is certified that error appears in the above-identified patent and that said Letters Patent is hereby corrected as shown below:

Figures 10, 11 and 12 were left off the patent. Shown in attached.  
Figure 13 was left off the patent. Shown in attached.

Signed and Sealed this

Ninth Day of January, 2007

A handwritten signature in black ink on a light gray dotted background. The signature reads "Jon W. Dudas" in a cursive style.

JON W. DUDAS

*Director of the United States Patent and Trademark Office*



**FIG. 10**



**FIG. 11**

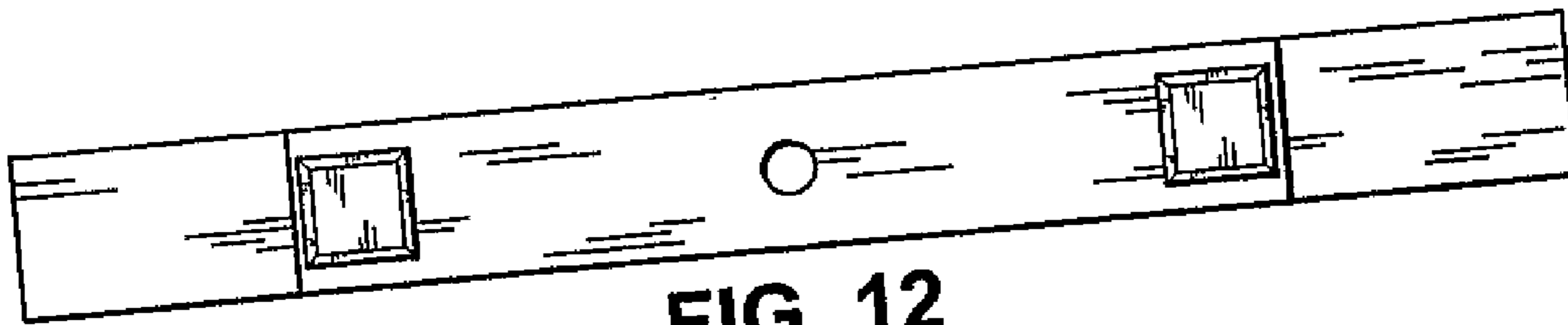

**FIG. 12**

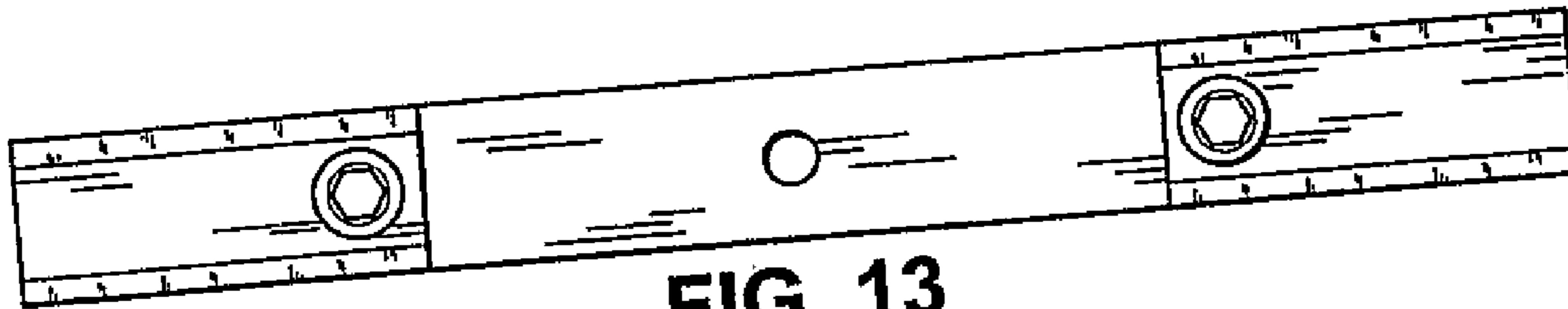

**FIG. 13**