

US00D497069S1

(12) **United States Design Patent**
Aisley et al.

(10) **Patent No.:** **US D497,069 S**
(45) **Date of Patent:** **** Oct. 12, 2004**

(54) **MEDICINE CABINET**

(75) Inventors: **William J. Aisley**, Westlake Village, CA (US); **Zachary Aisley**, Westlake Village, CA (US)

(73) Assignee: **Zaca, Inc.**, Westlake Village, CA (US)

(**) Term: **14 Years**

(21) Appl. No.: **29/194,921**

(22) Filed: **Dec. 2, 2003**

(51) **LOC (7) Cl.** **06-04**

(52) **U.S. Cl.** **D6/559**

(58) **Field of Search** D6/553, 559, 560-561, D6/329, 396, 432, 448, 436-439, 444-446; 312/209, 234, 224-225, 242, 245; 206/320, 823

(56) **References Cited**

U.S. PATENT DOCUMENTS

- D224,592 S * 8/1972 Fudge D6/559
- 4,076,350 A * 2/1978 Crist 312/242
- 5,139,322 A 8/1992 Aisley
- 5,189,760 A 3/1993 Aisley
- 5,255,971 A 10/1993 Aisley

- 5,267,786 A 12/1993 Aisley
- D353,068 S * 12/1994 Goldstein D6/559
- D403,907 S * 1/1999 Kato D6/559
- D418,347 S * 1/2000 Dragonette D6/559
- D426,996 S * 6/2000 Kourembanas D6/559

* cited by examiner

Primary Examiner—Brian N Vinson

(74) *Attorney, Agent, or Firm*—Kelly Lowry & Kelley LLP

(57) **CLAIM**

The ornamental design for a medicine cabinet, as shown.

DESCRIPTION

FIG. 1 is a front, top and left-side perspective view of a medicine cabinet embodying our new design;
 FIG. 2 is a front elevational view thereof;
 FIG. 3 is a rear elevational view thereof;
 FIG. 4 is a top plan view thereof;
 FIG. 5 is a bottom plan view thereof;
 FIG. 6 is a left-side elevational view thereof;
 FIG. 7 is a right-side elevational view thereof;
 FIG. 8 is a perspective view similar to FIG. 1, illustrating the door in an open configuration relative to housing; and,
 FIG. 9 is a front elevational view of FIG. 8.

1 Claim, 3 Drawing Sheets

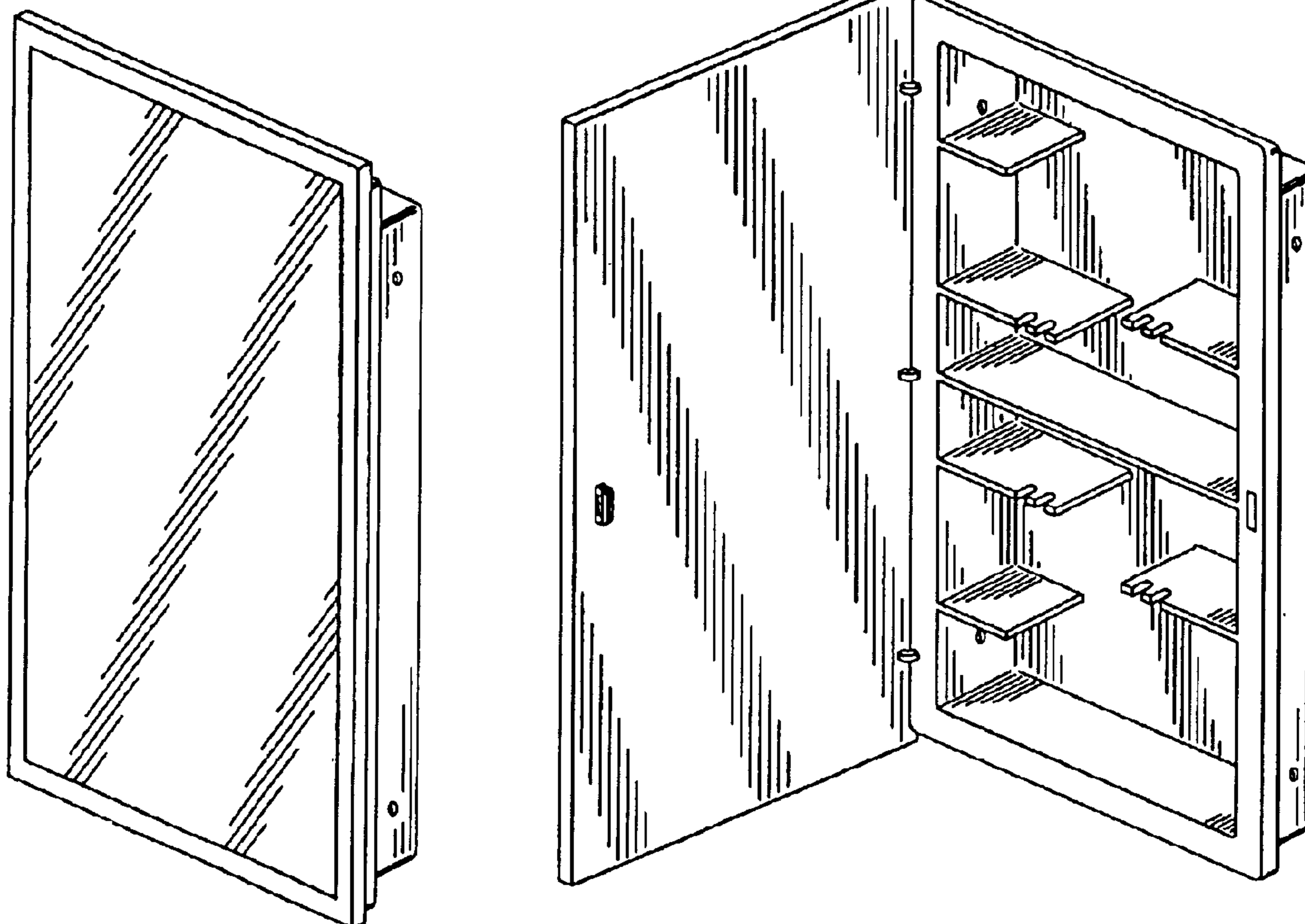

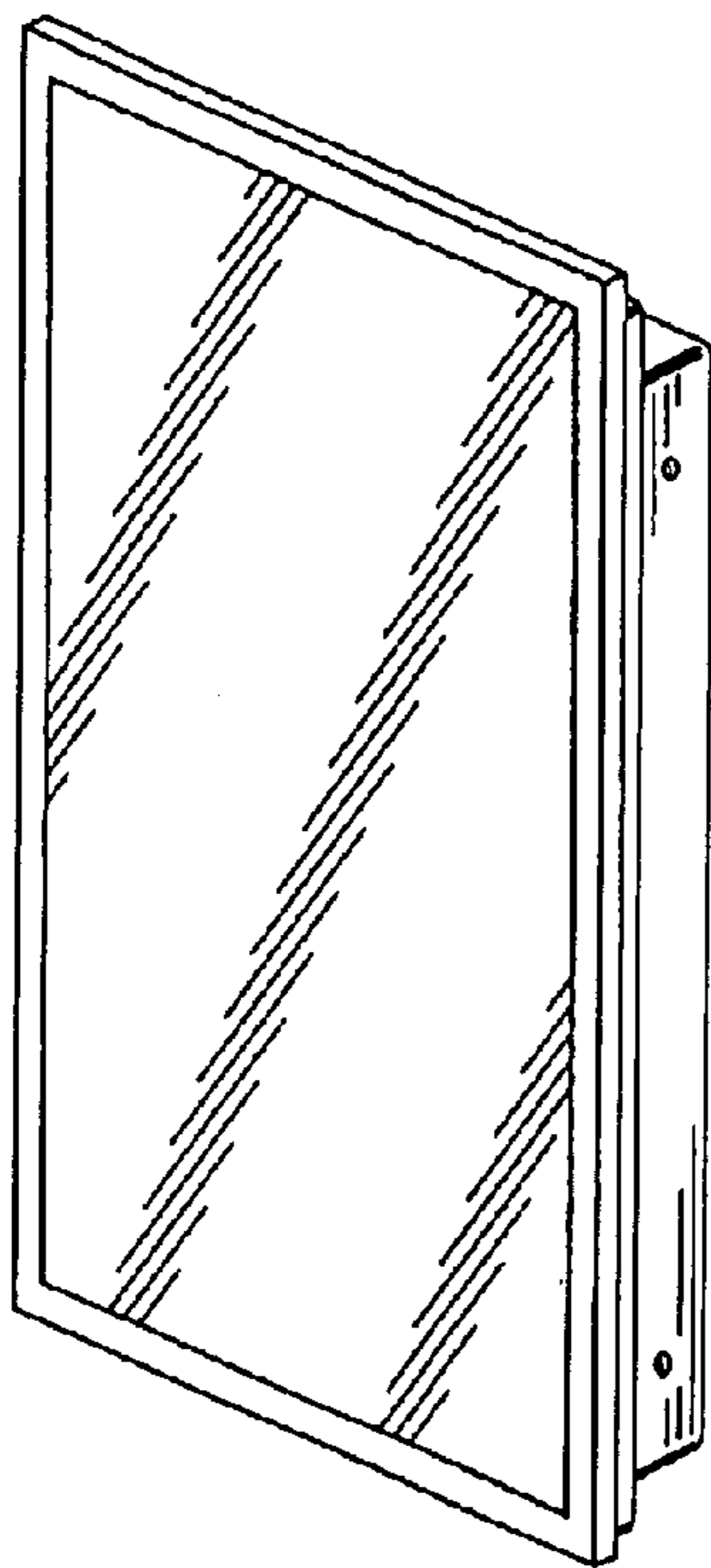

FIG. 1

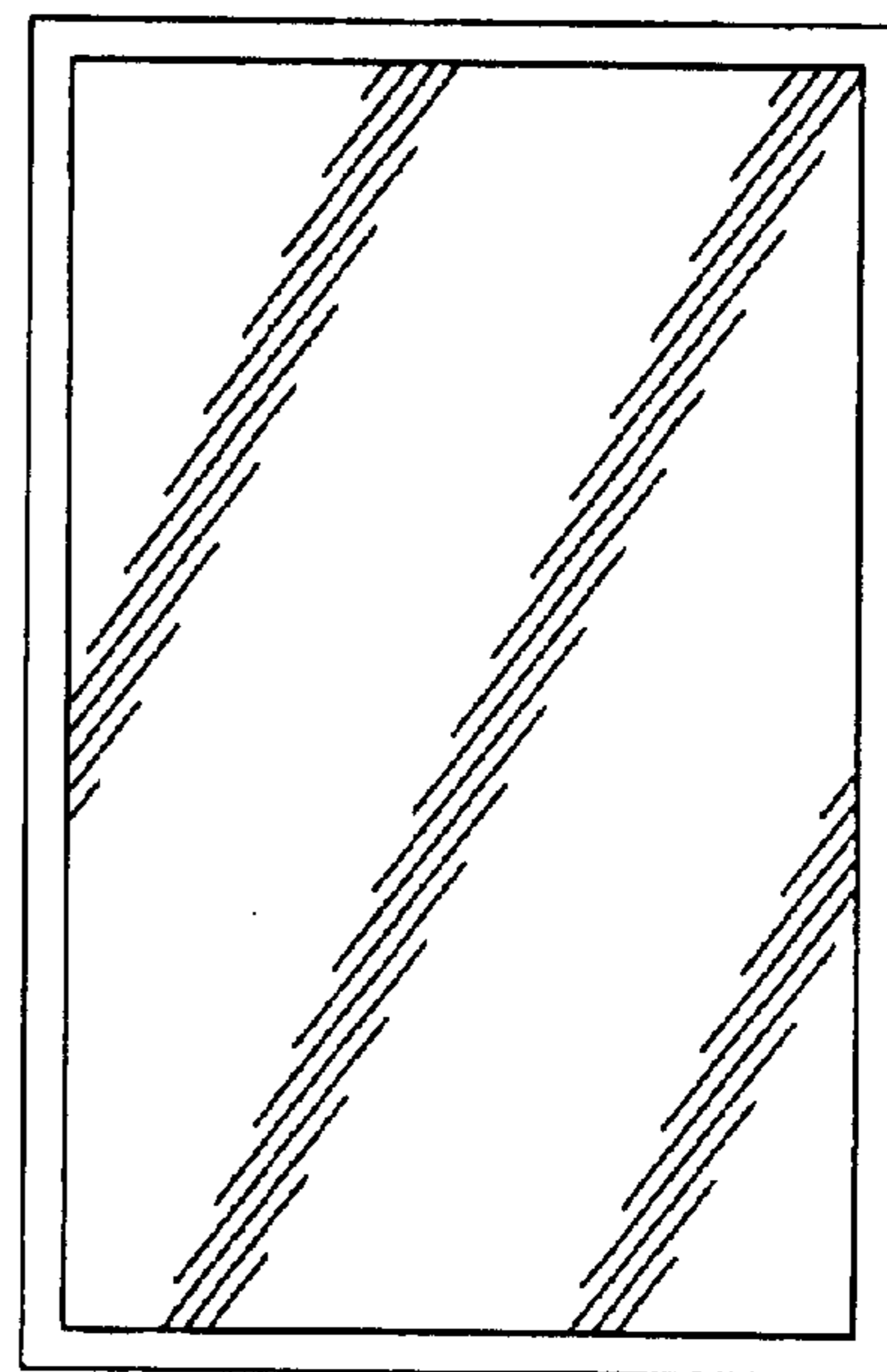

FIG. 2

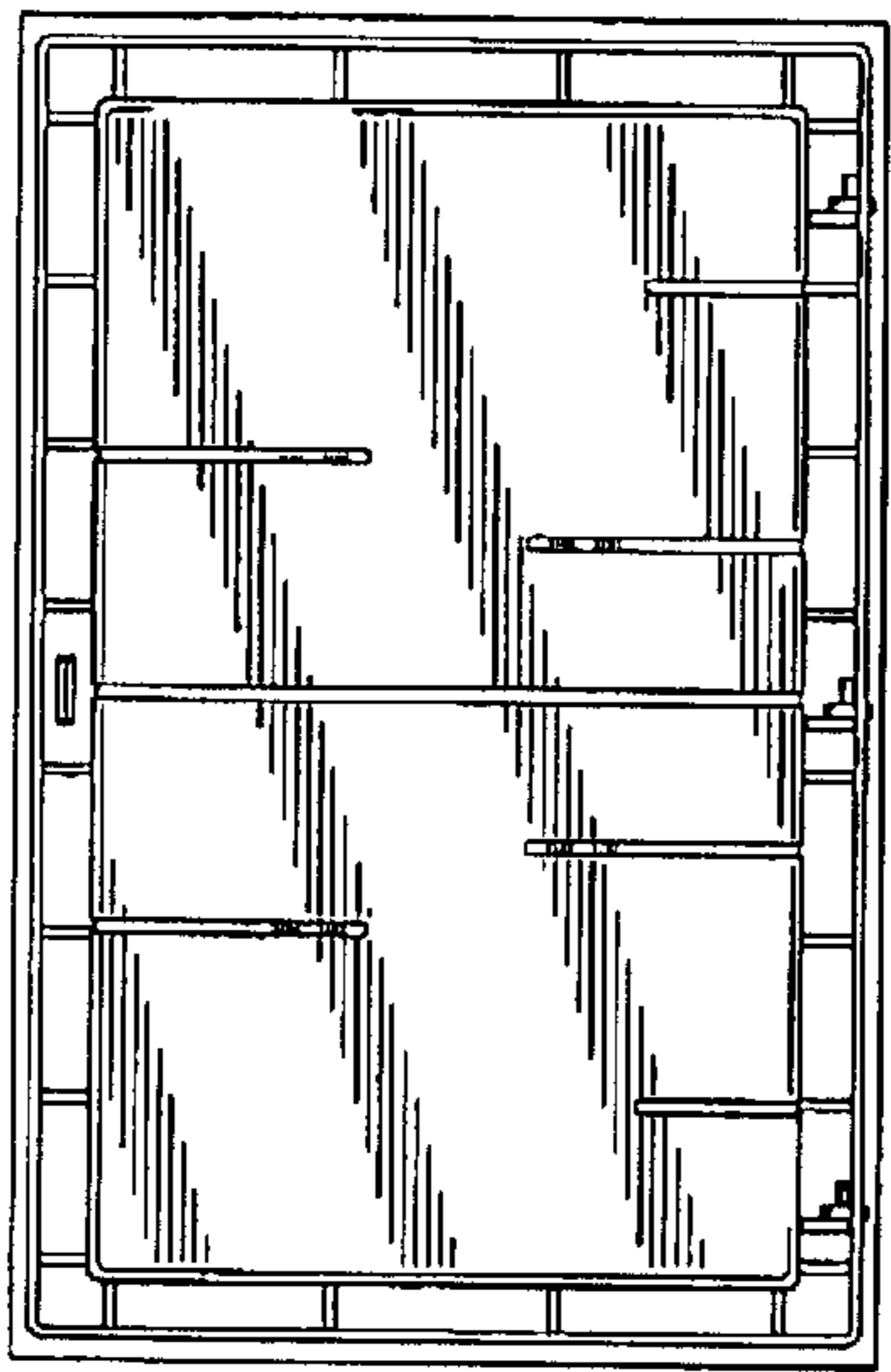

FIG. 3

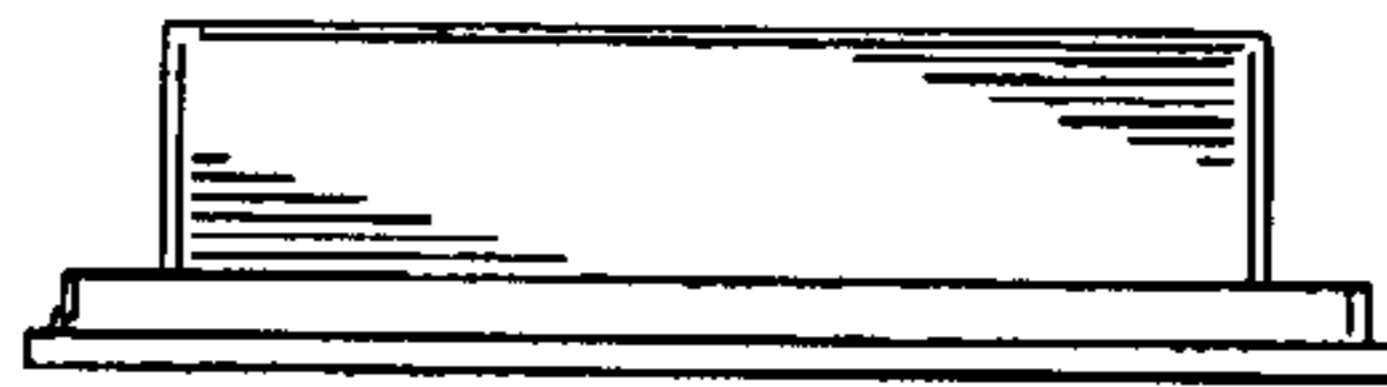

FIG. 4

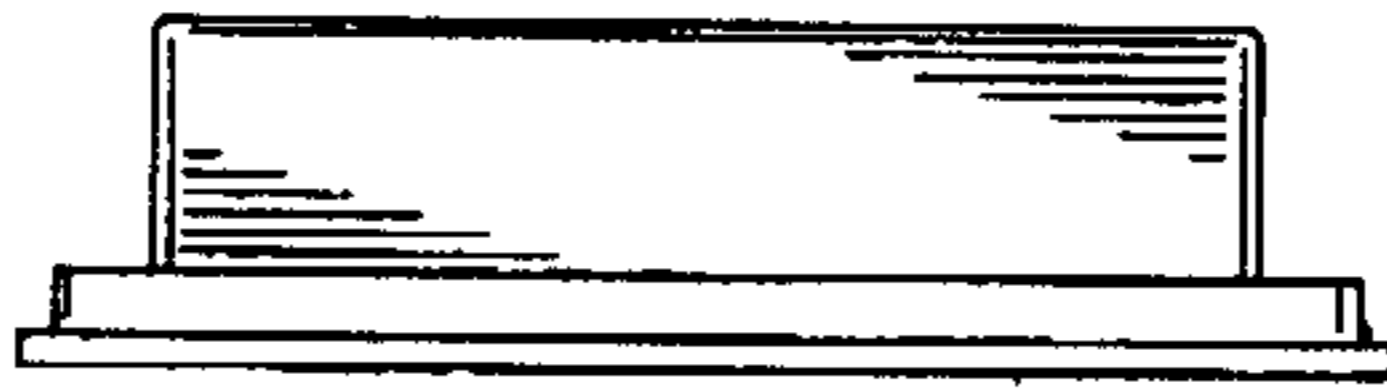

FIG. 5

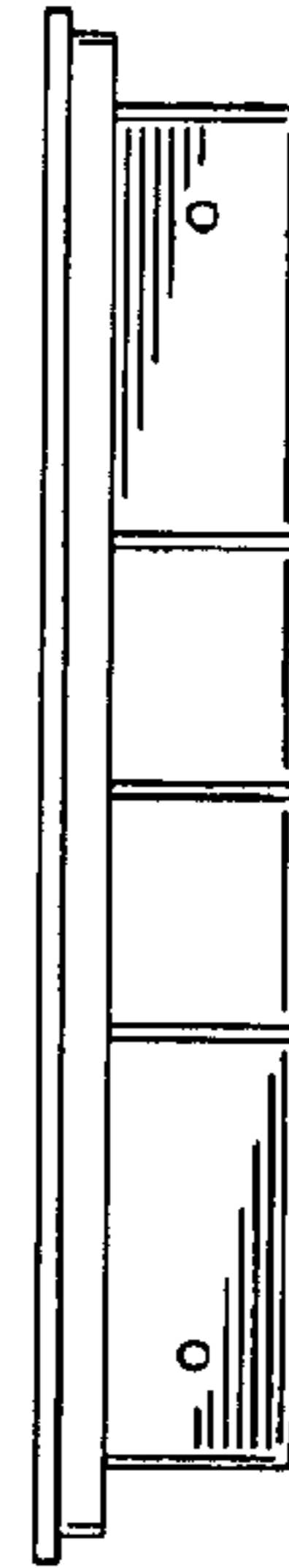

FIG. 6

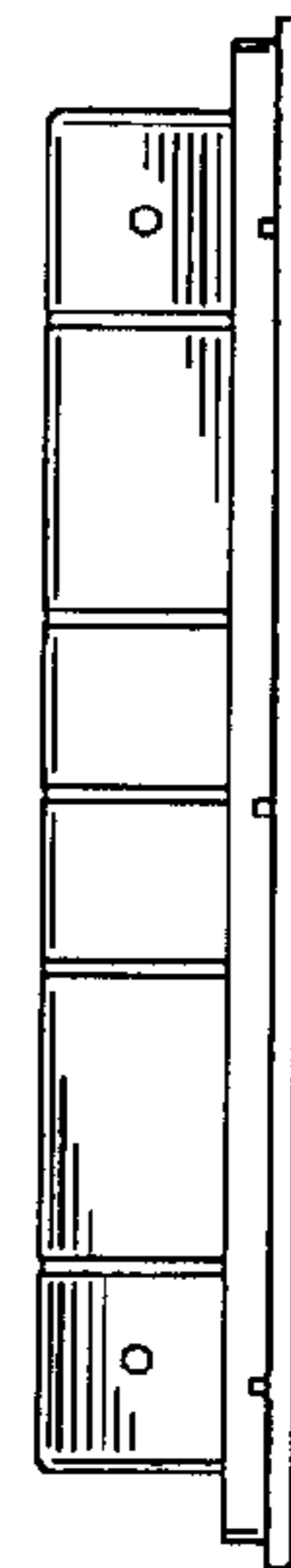

FIG. 7

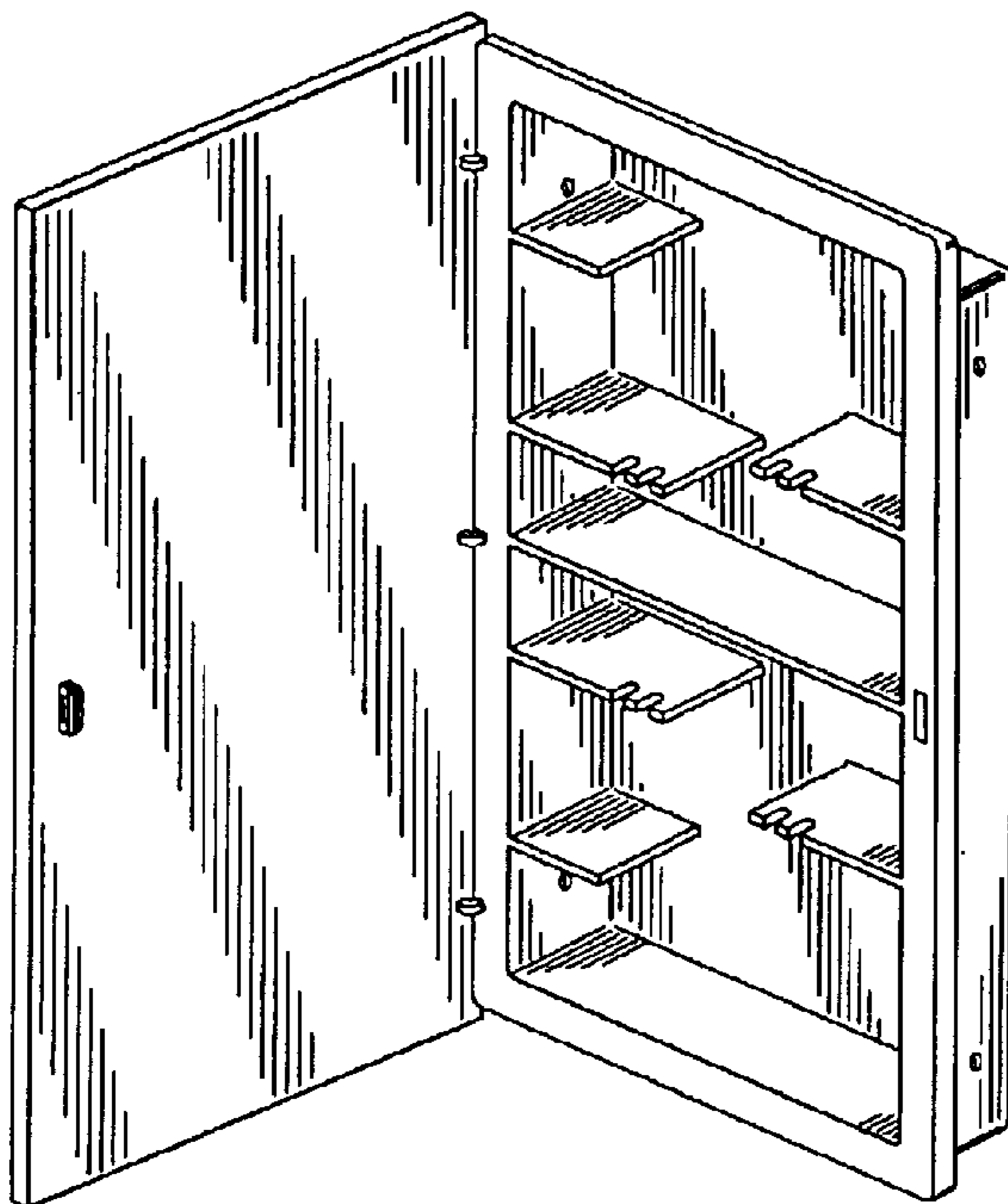

FIG. 8

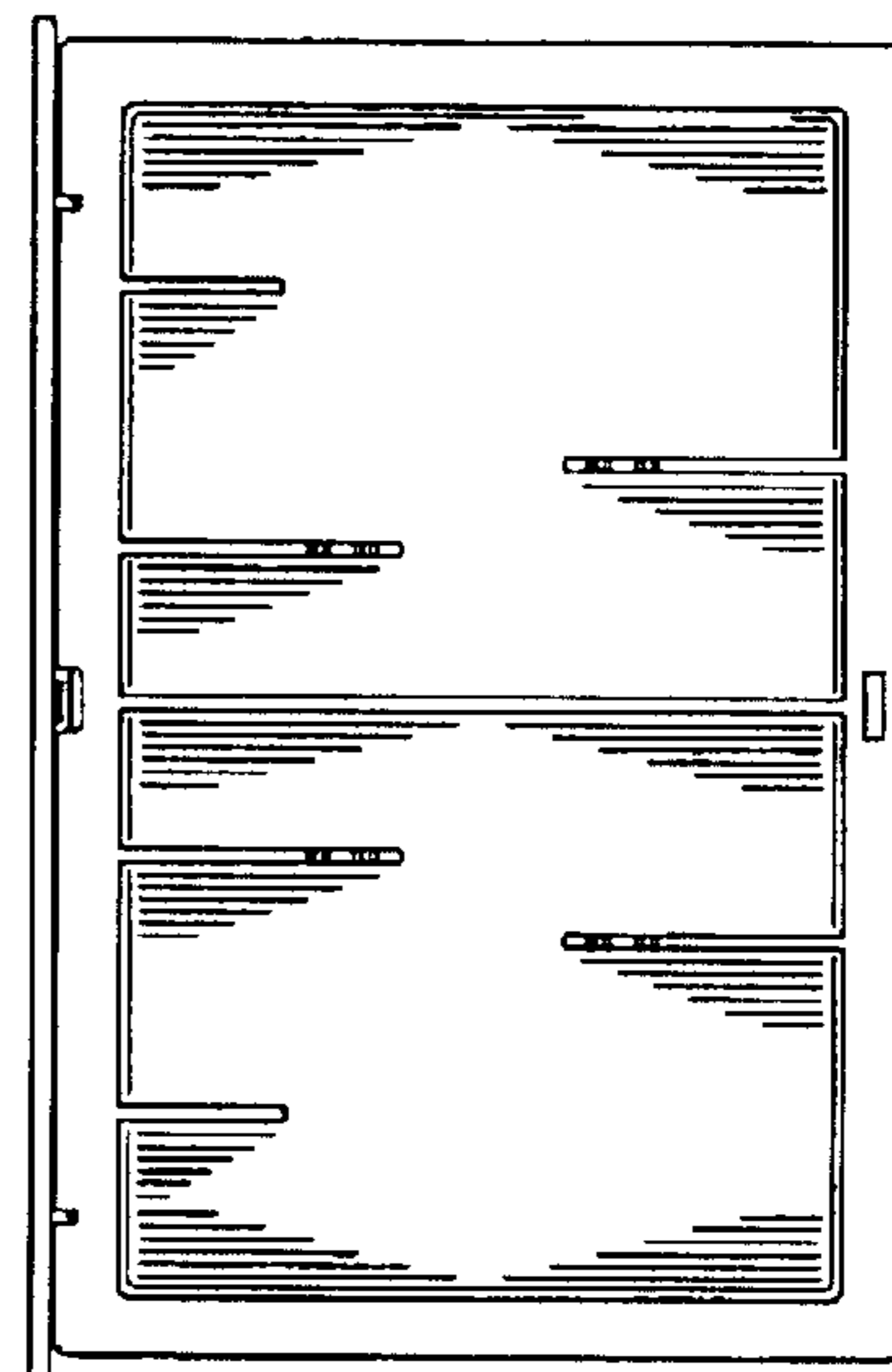

FIG. 9