

US00D496712S1

(12) **United States Design Patent** (10) **Patent No.:** **US D496,712 S**
Schiller et al. (45) **Date of Patent:** **** Sep. 28, 2004**

(54) **HAND HELD SHOWER**

(75) Inventors: **Rolf Schiller**, Inving (DE); **Wolfgang Brandt**, Ocholt (DE); **Hans-Georg Kasten**, Seefeld (DE)

(73) Assignee: **Huppe GmbH & Co., oHG** (DE)

(**) Term: **14 Years**

(21) Appl. No.: **29/185,113**

(22) Filed: **Jun. 23, 2003**

(51) **LOC (7) Cl.** **23-01**

(52) **U.S. Cl.** **D23/229; D23/213**

(58) **Field of Search** **D23/213, 223, D23/229, 230; 239/282, 283, 556**

(56) **References Cited**

U.S. PATENT DOCUMENTS

D471,953 S	*	3/2003	Colligan et al.	D23/213
D485,887 S	*	1/2004	Luetgen et al.	D23/223
D488,207 S	*	4/2004	Marshall	D23/213

* cited by examiner

Primary Examiner—Robin V. Taylor
(74) Attorney, Agent, or Firm—Kwadjo Adusei-Poku; Lloyd D. Doigan

(57) **CLAIM**

The ornamental design for a hand held shower, as shown and described.

DESCRIPTION

FIG. 1 is a top perspective view of a hand held shower showing our new design;

FIG. 2 is a bottom perspective view thereof;

FIG. 3 is a right side elevational view thereof;

FIG. 4 is a left side elevational view thereof;

FIG. 5 is a top plan view thereof;

FIG. 6 is a bottom plan view thereof;

FIG. 7 is a front elevational view thereof; and,

FIG. 8 is a rear elevational view thereof.

The broken line showing is for illustrative purposes only and forms no part of the claimed design.

1 Claim, 4 Drawing Sheets

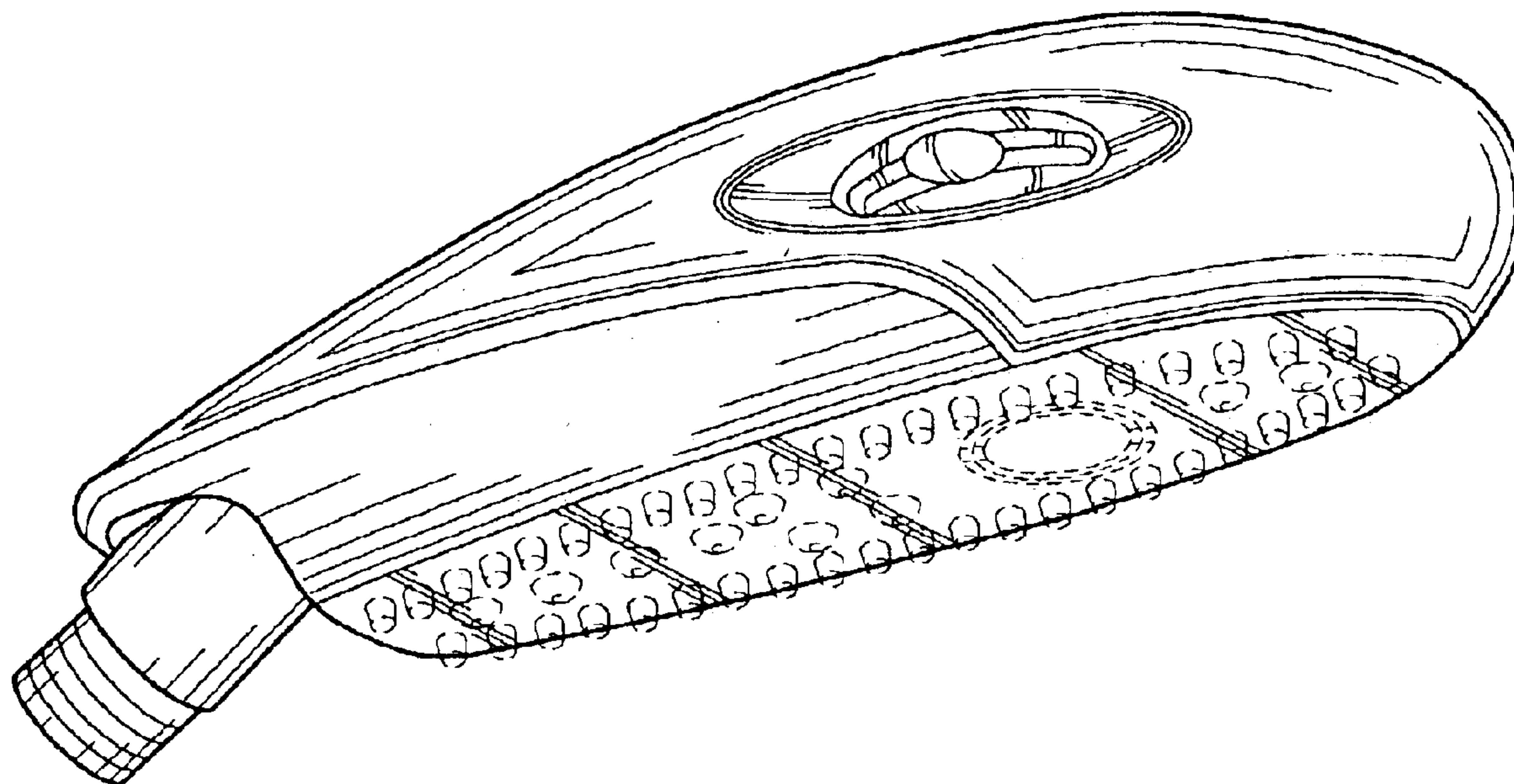

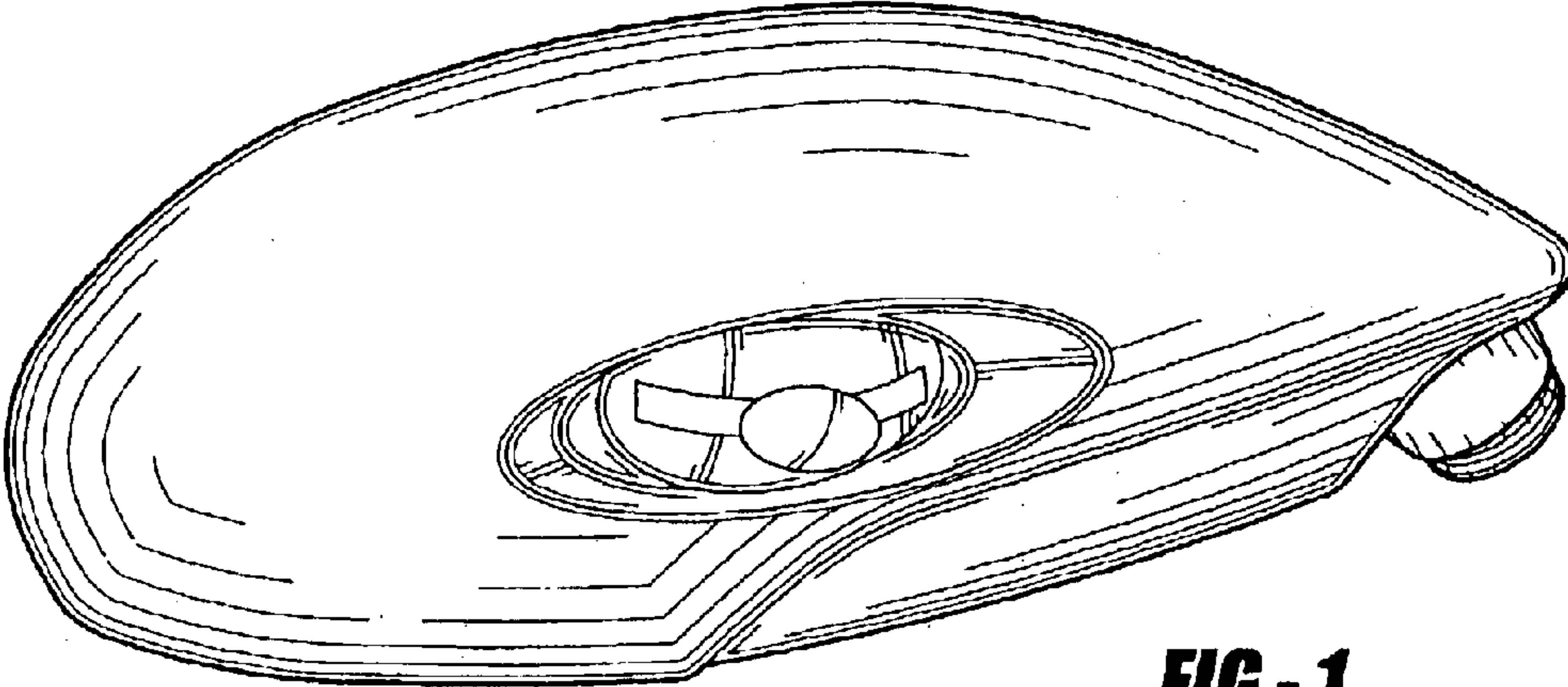

FIG - 1

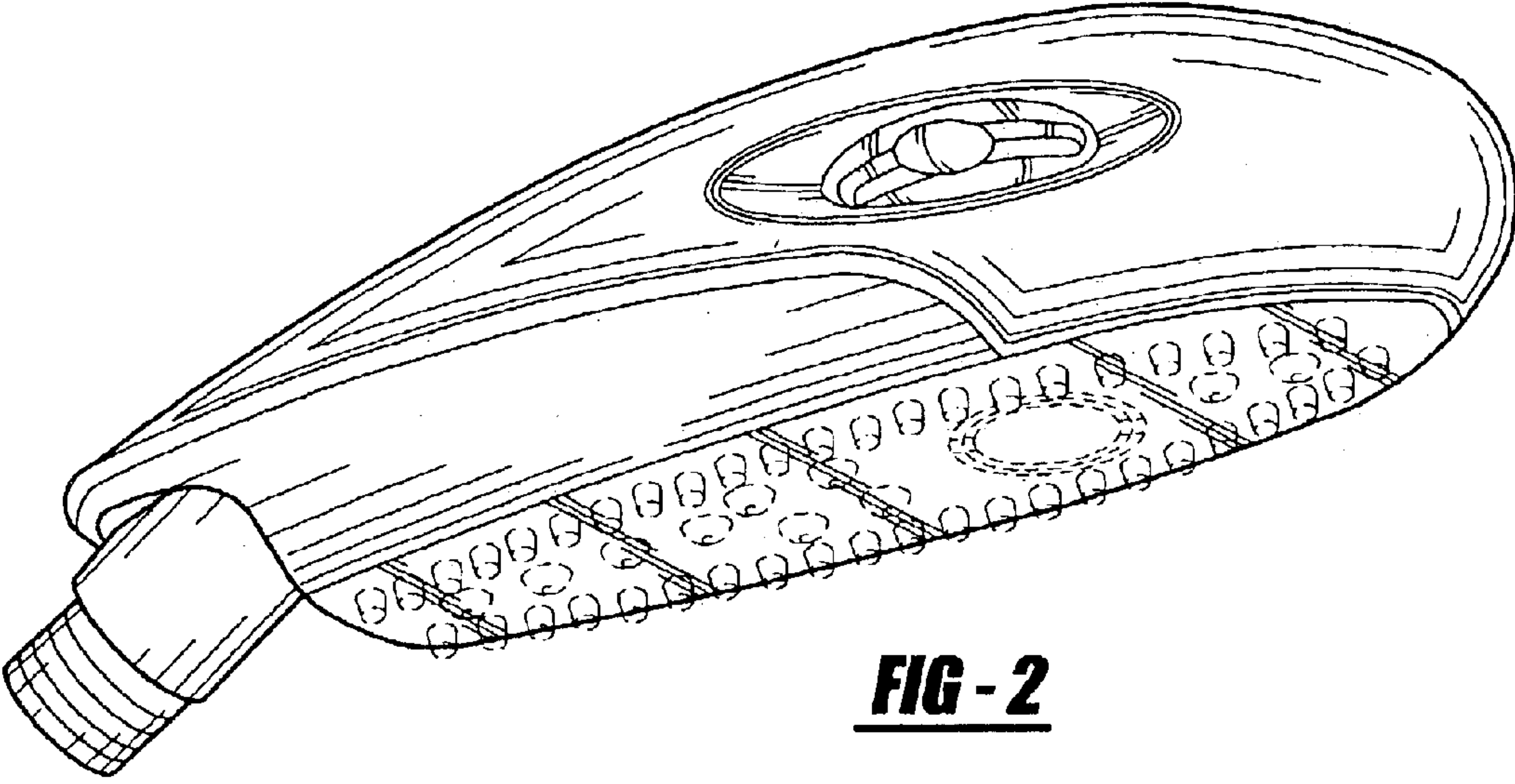

FIG - 2

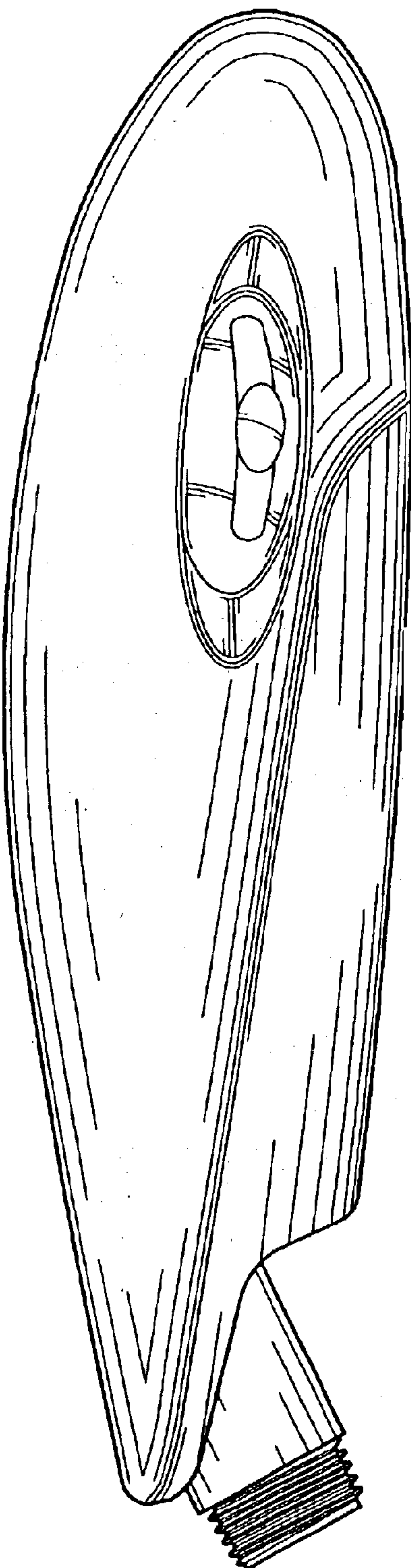

FIG - 3

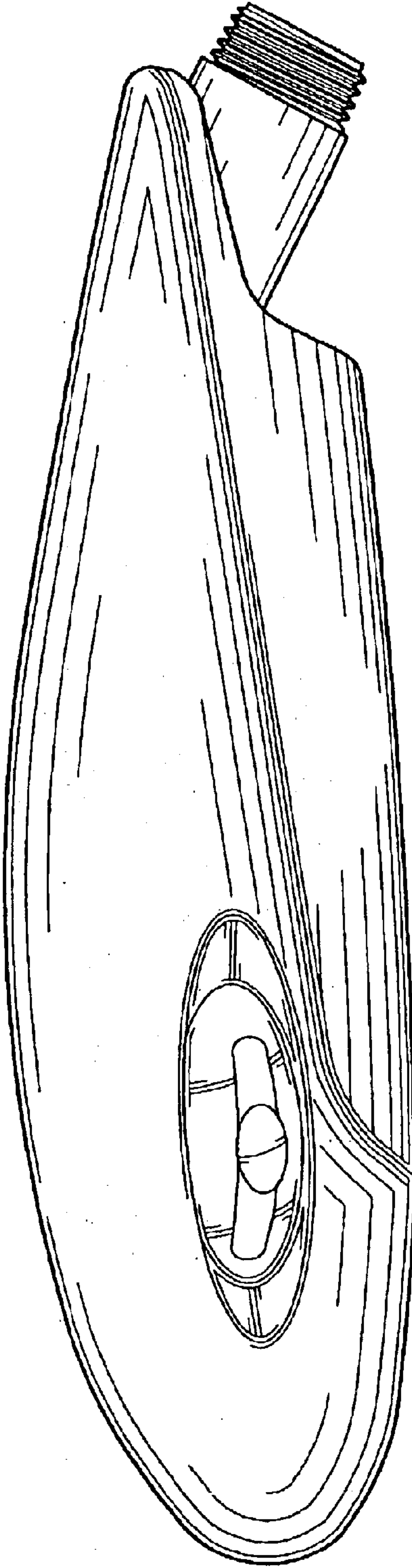

FIG - 4

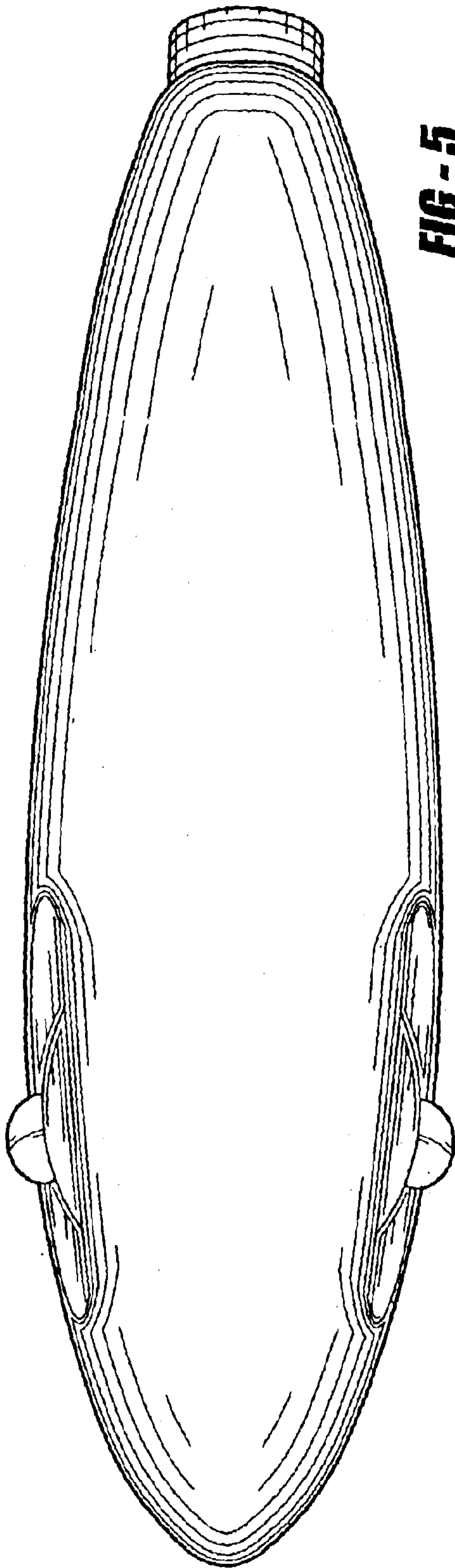

FIG-5

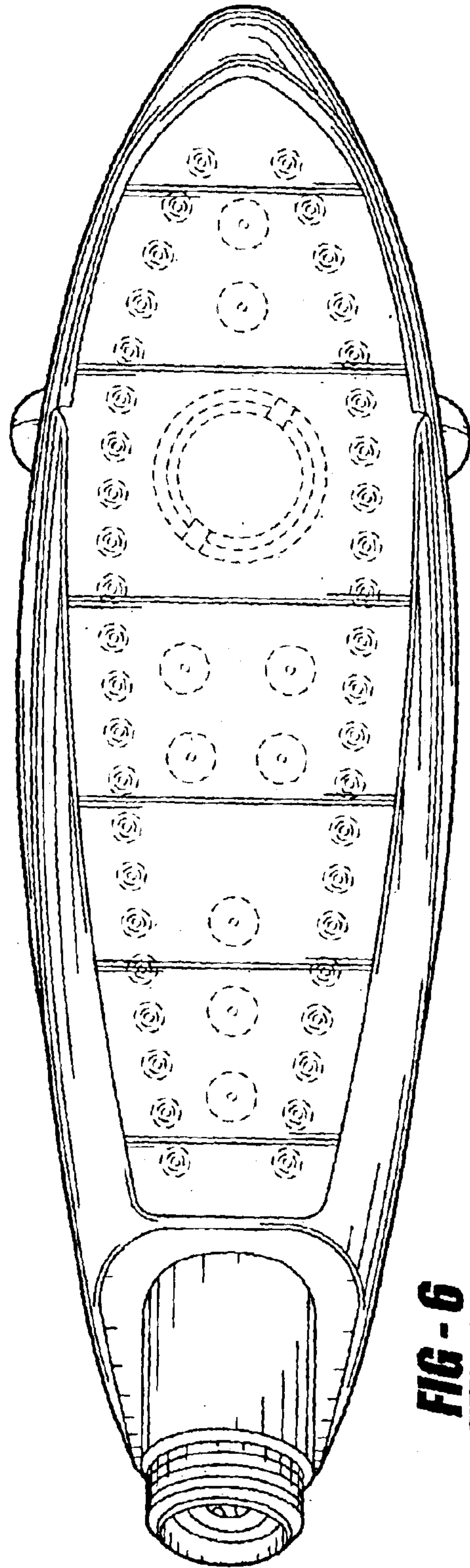

FIG-6

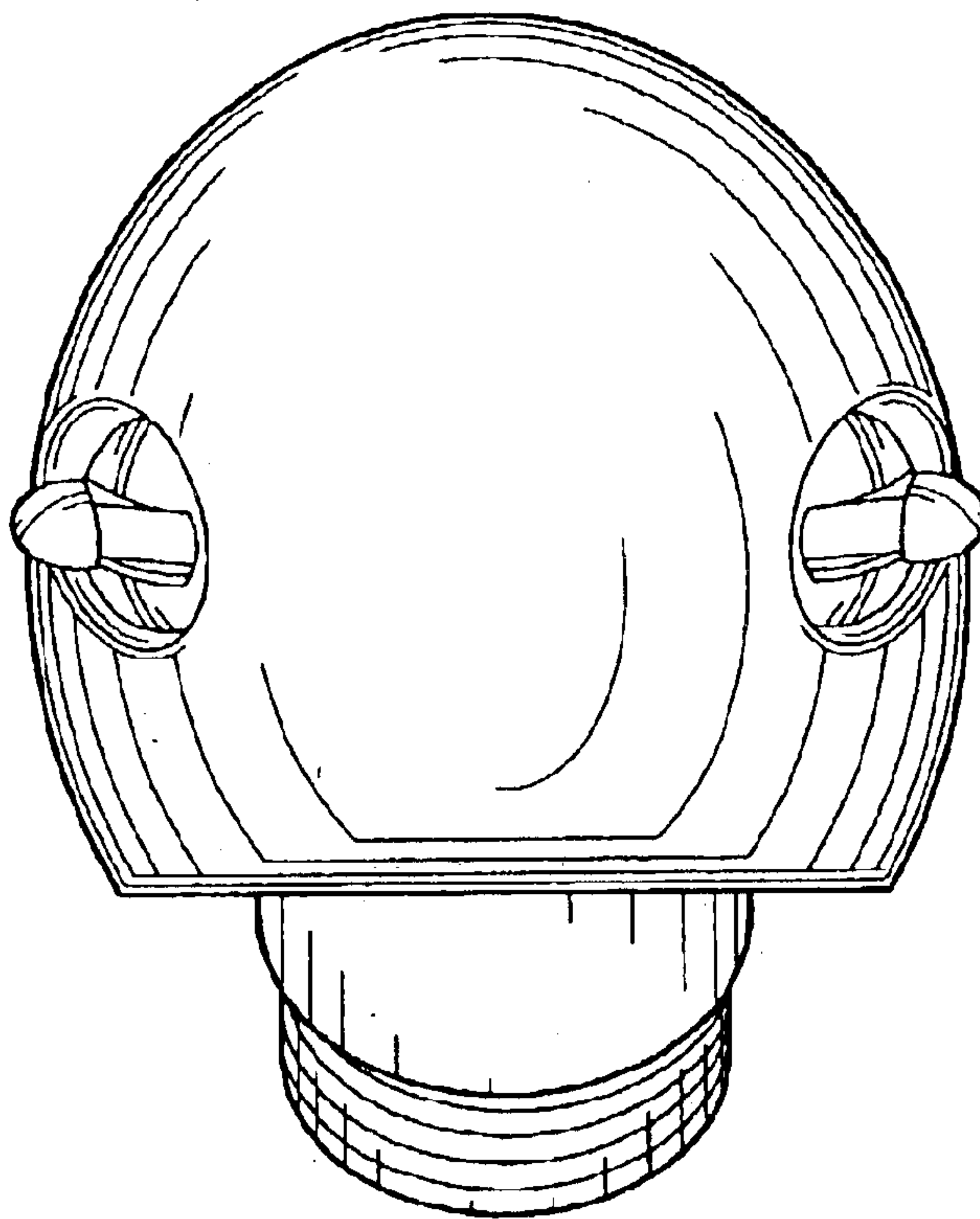

FIG - 7

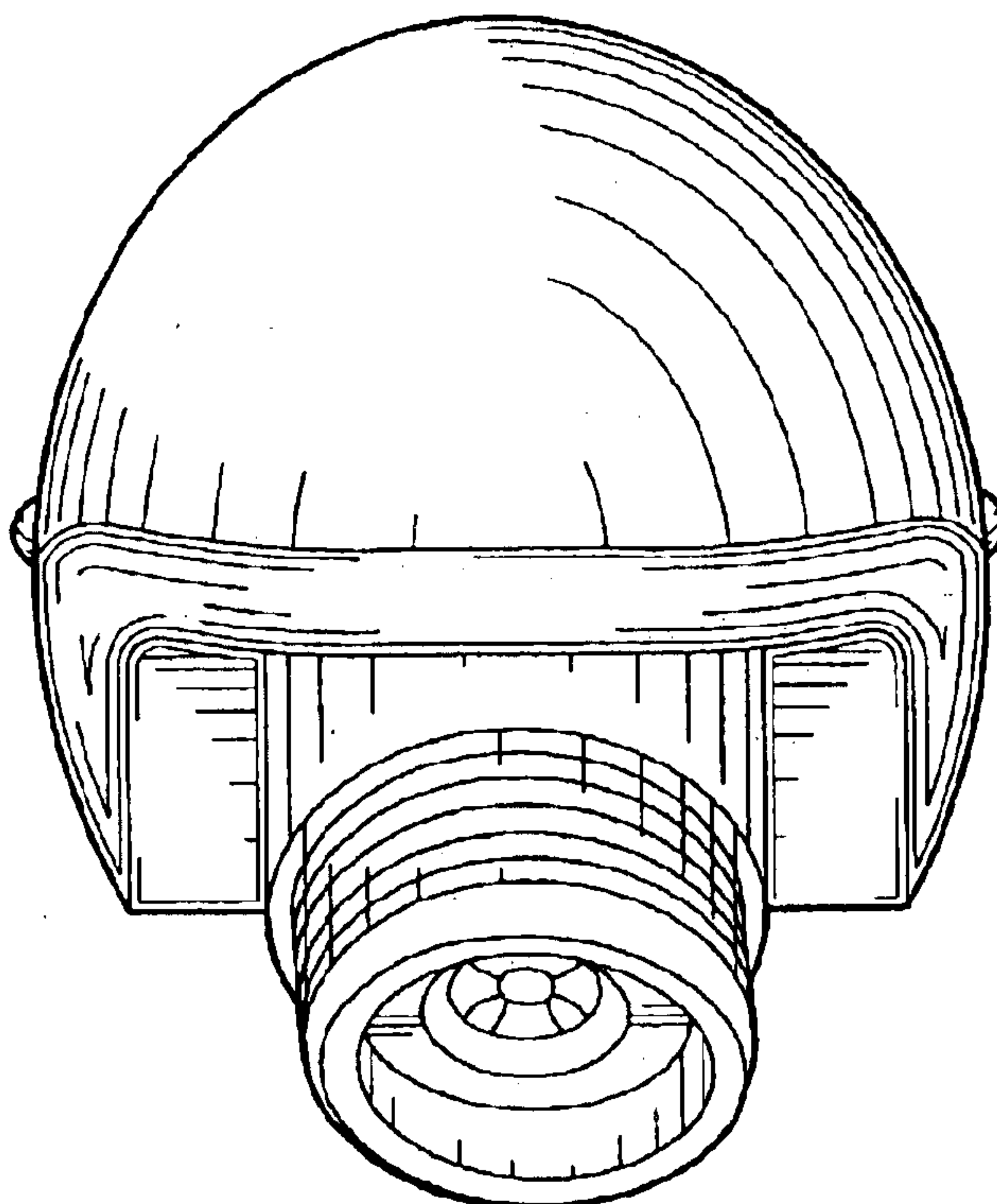

FIG - 8