

US00D496584S1

(12) **United States Design Patent**
Darr et al.

(10) **Patent No.: US D496,584 S**
(45) **Date of Patent: ** Sep. 28, 2004**

(54) **HANDLE FOR CONTAINER**

(75) Inventors: **Richard C. Darr**, Medina, OH (US);
James J. Miller, Barberton, OH (US);
Richard A. Lovelace, Jr., Akron, OH
(US); **Thomas J. Simpson**,
Marshallville, OH (US)

(73) Assignee: **Plastipak Packaging, Inc.**, Plymouth,
MI (US)

(**) Term: **14 Years**

(21) Appl. No.: **29/191,870**

(22) Filed: **Oct. 15, 2003**

(51) **LOC (7) Cl. 09-03**

(52) **U.S. Cl. D9/344**

(58) **Field of Search** D9/344, 434, 443,
D9/455, 499; 206/139-140, 142, 151, 158,
159, 485; 220/23.83, 694, 696, 915.1

(56) **References Cited**

U.S. PATENT DOCUMENTS

3,202,309	A	*	8/1965	Simpson	215/395
D251,766	S	*	5/1979	Hammerschmidt	D7/622
D288,666	S	*	3/1987	Brun	D9/434
D327,221	S	*	6/1992	Simmons	D9/434
D349,241	S	*	8/1994	Isaacson	D9/443
D449,993	S	*	11/2001	Schumann	D9/531
D460,669	S	*	7/2002	Cizek	D8/26
D462,879	S	*	9/2002	Martens	D7/622
D476,569	S	*	7/2003	Simkins	D9/455
2002/0066758	A1	*	6/2002	Fadal et al.	224/148.7

* cited by examiner

Primary Examiner—Stella Reid
Assistant Examiner—Daniel Bui

(74) *Attorney, Agent, or Firm*—Robert H. Bachman

(57) **CLAIM**

The ornamental design for a handle for container, as shown and described.

DESCRIPTION

FIG. 1 is a front perspective view of a handle for container of the present invention.

FIG. 2 is a top view thereof.

FIG. 3 is a bottom view thereof.

FIG. 4 is a back view thereof.

FIG. 5 is a front view thereof.

FIG. 6 is a left side view thereof.

FIG. 7 is a right side view.

FIG. 8 is a front perspective view of a handle for container of the present invention engaged with a container, with the container shown in broken lines for illustrative purposes only and form no part of the claimed design.

FIG. 9 is a front perspective view of a second embodiment of a handle for container of the present invention.

FIG. 10 is a top view thereof.

FIG. 11 is a bottom view thereof.

FIG. 12 is a back view thereof.

FIG. 13 is a front view thereof.

FIG. 14 is a left side view thereof; and,

FIG. 15 is a right side view thereof.

1 Claim, 7 Drawing Sheets

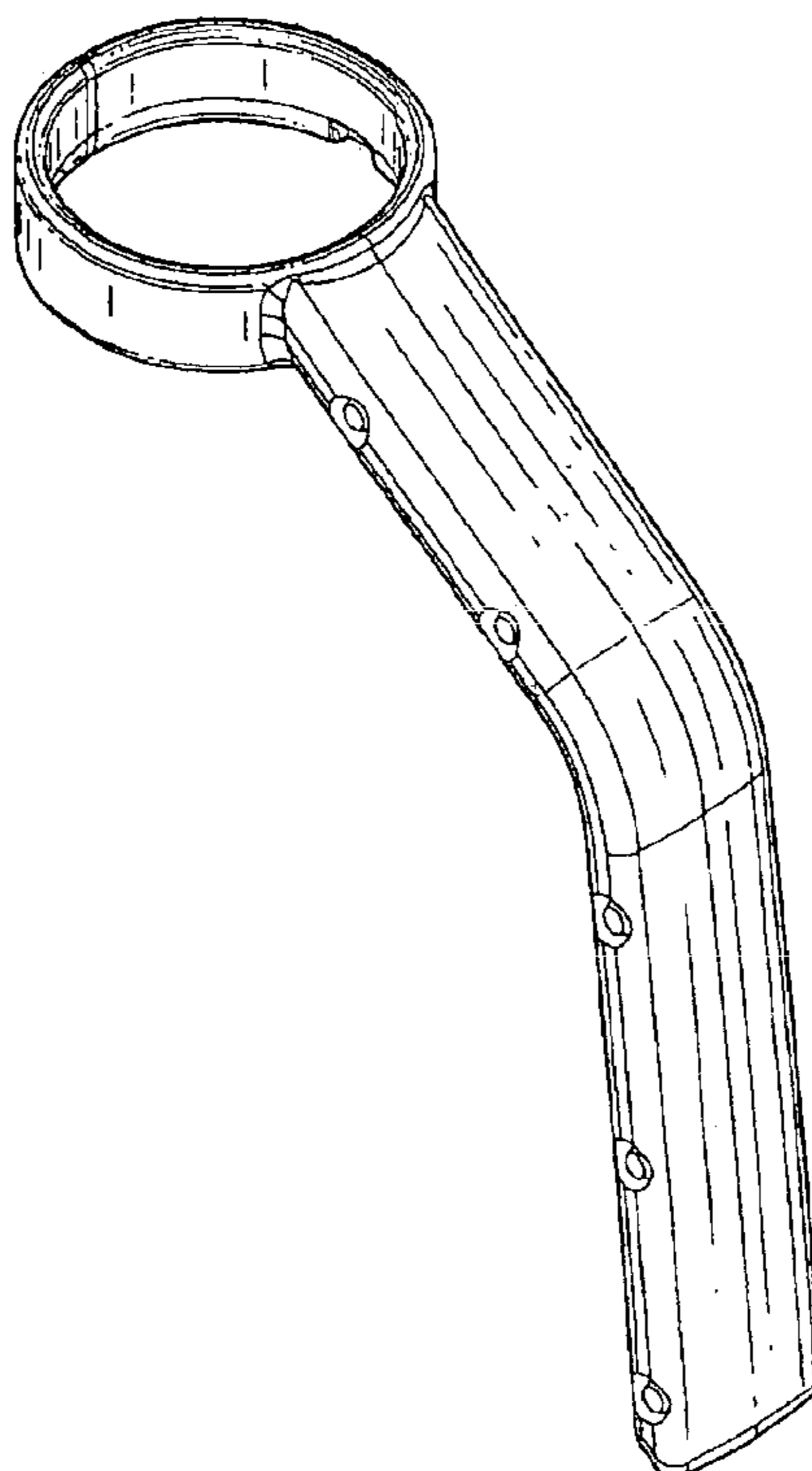

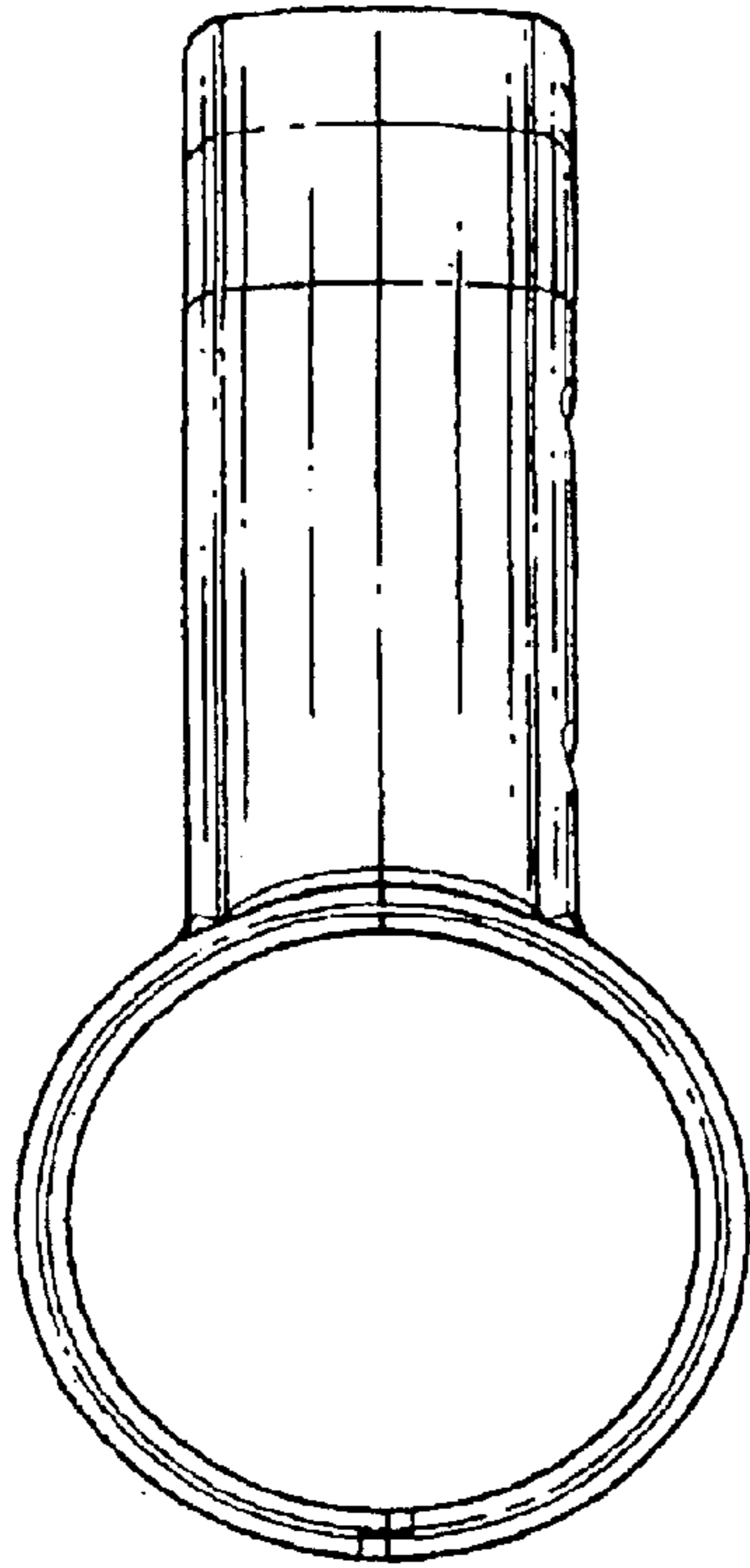

FIG. 2

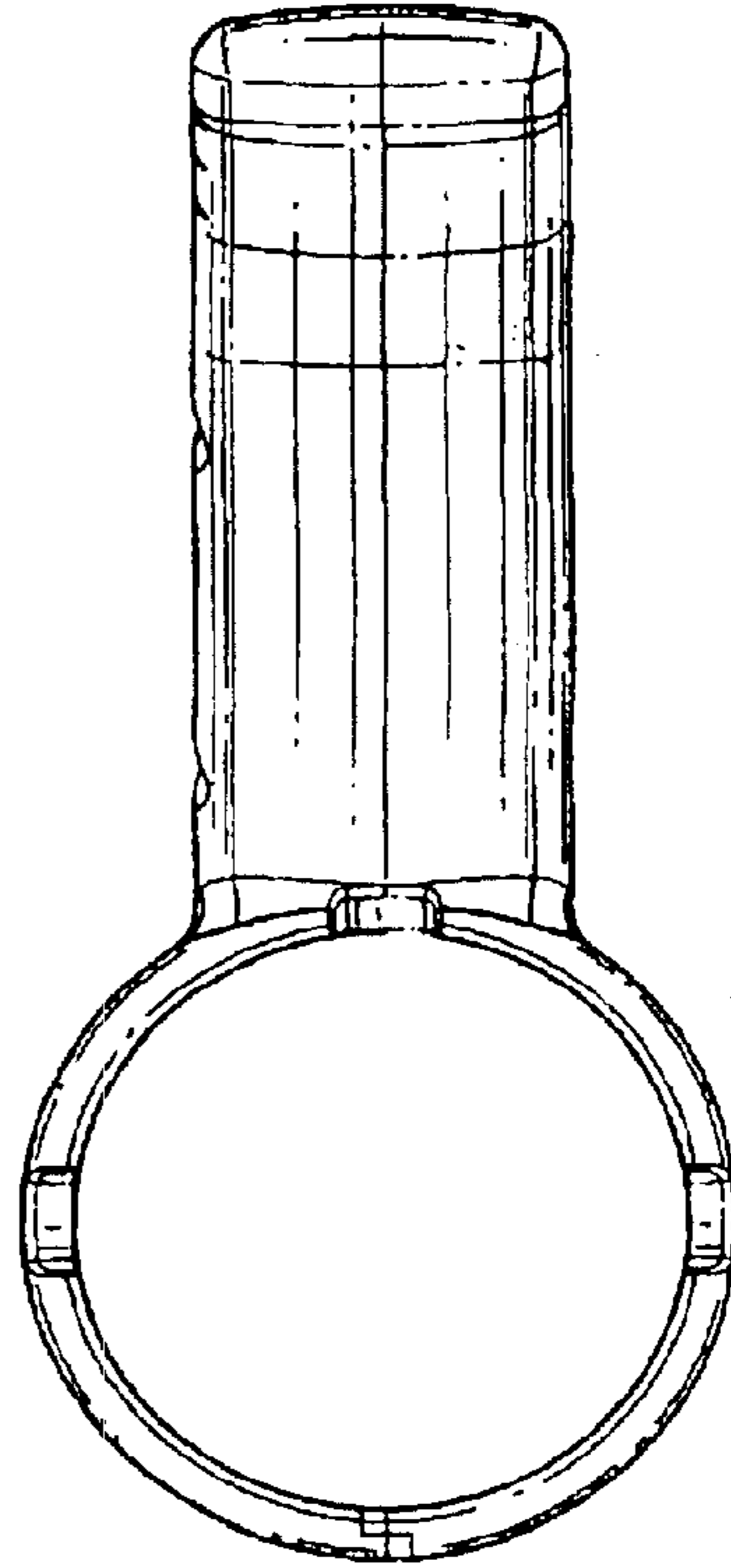

FIG. 3

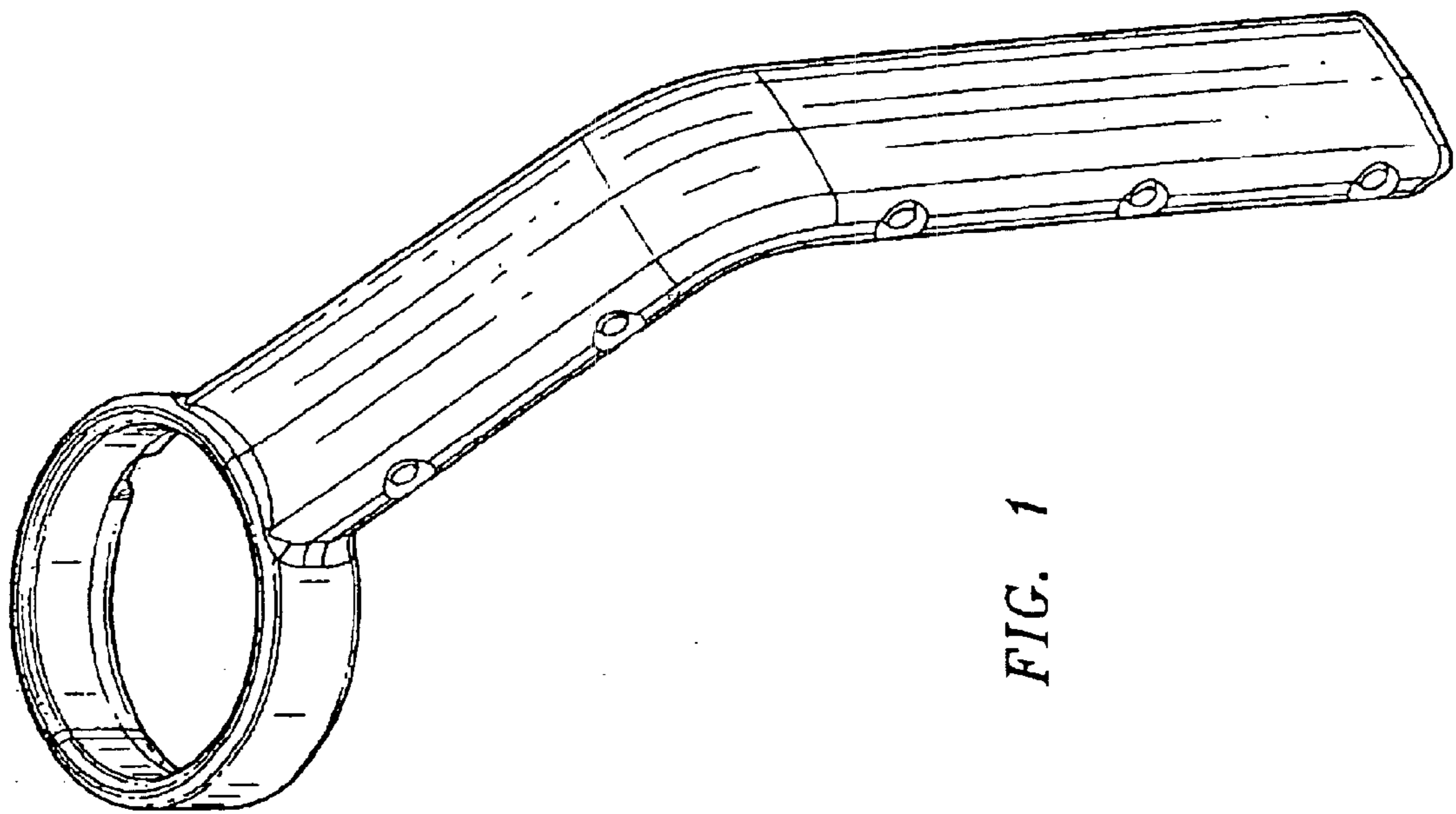

FIG. 1

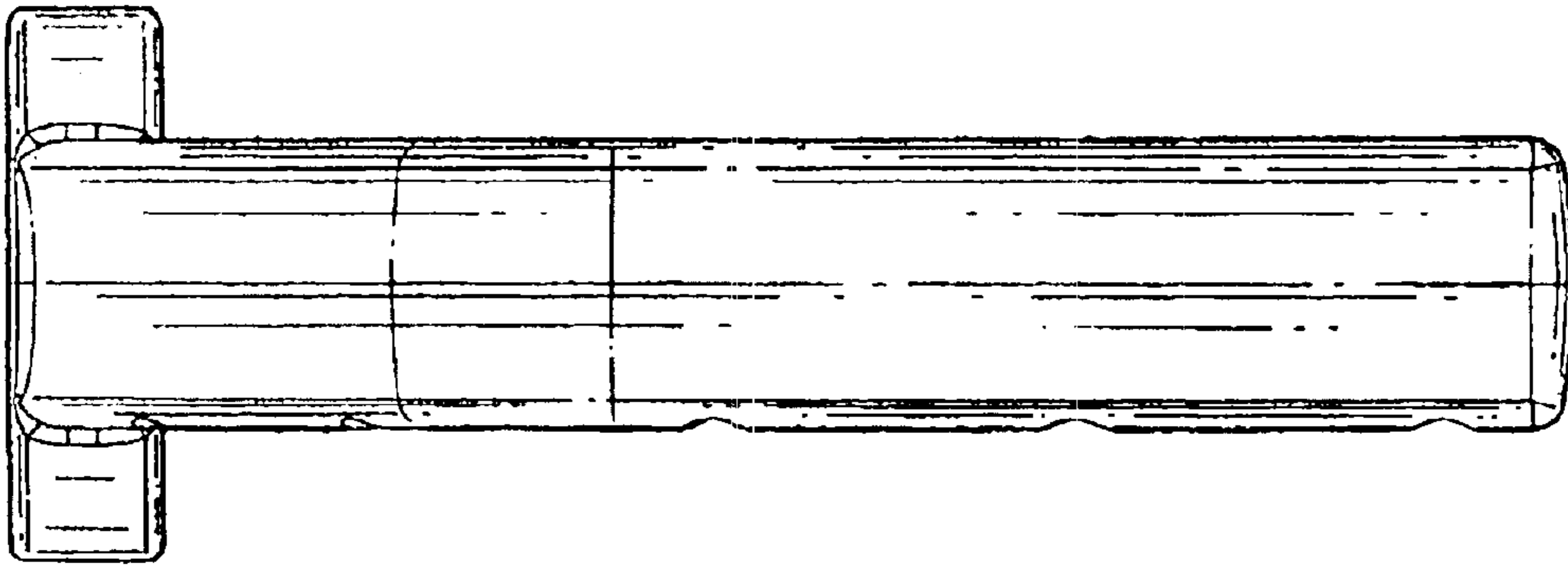

FIG. 5

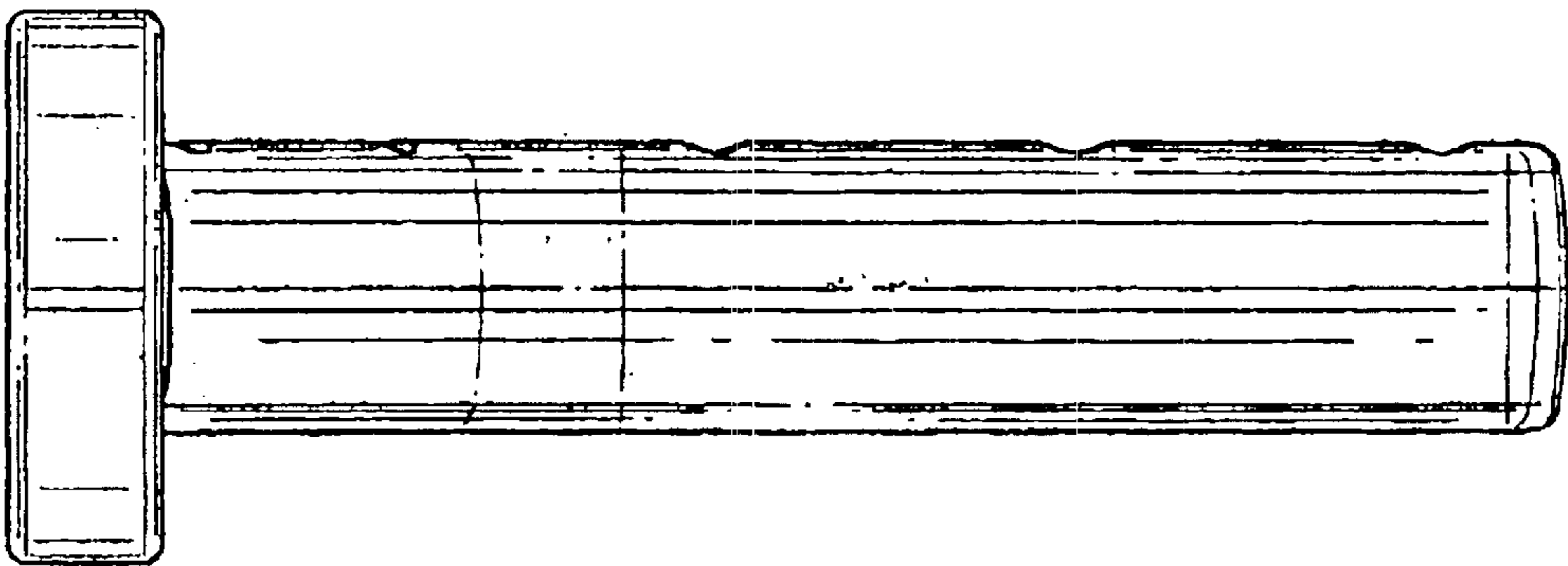

FIG. 4

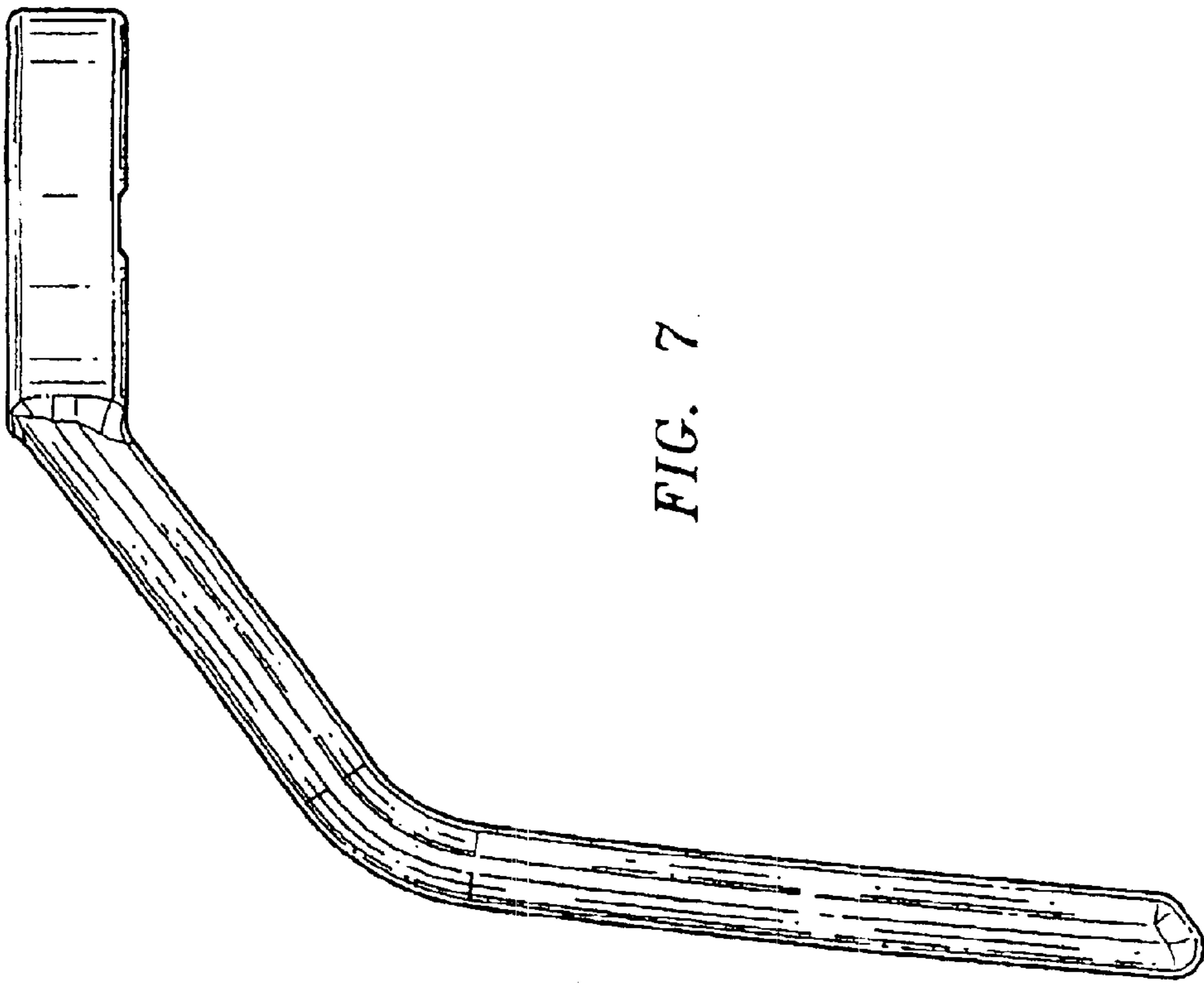

FIG. 7

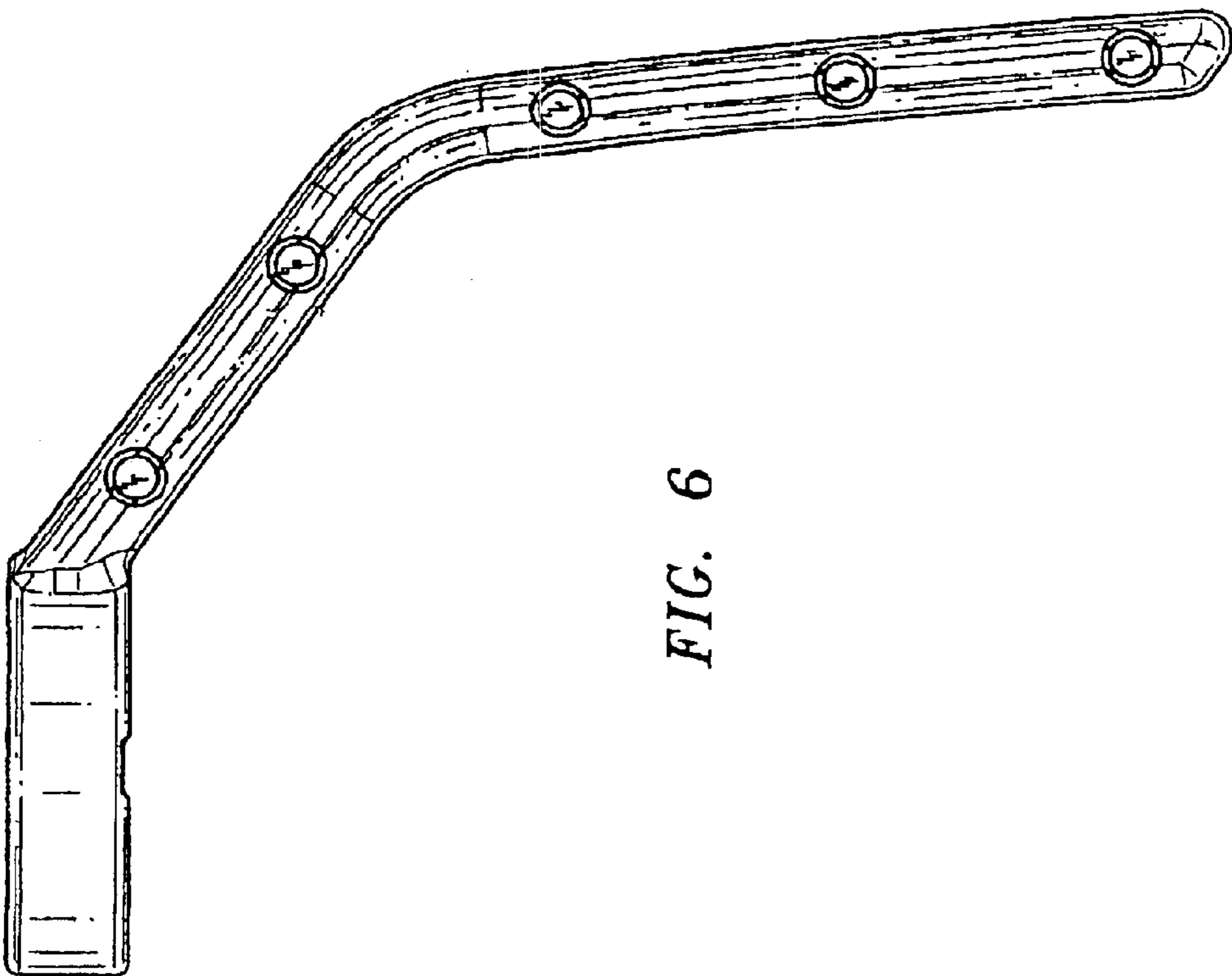

FIG. 6

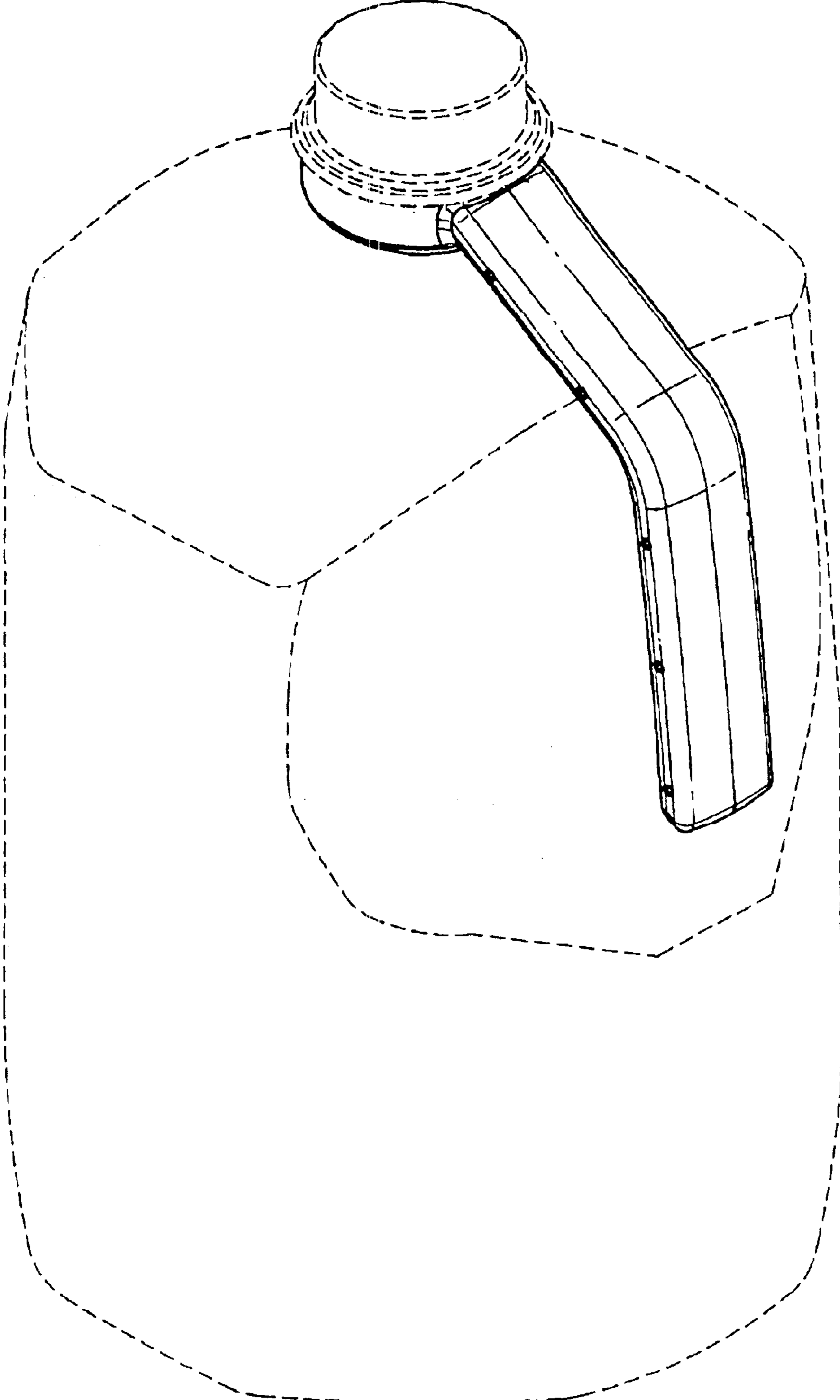

FIG. 8

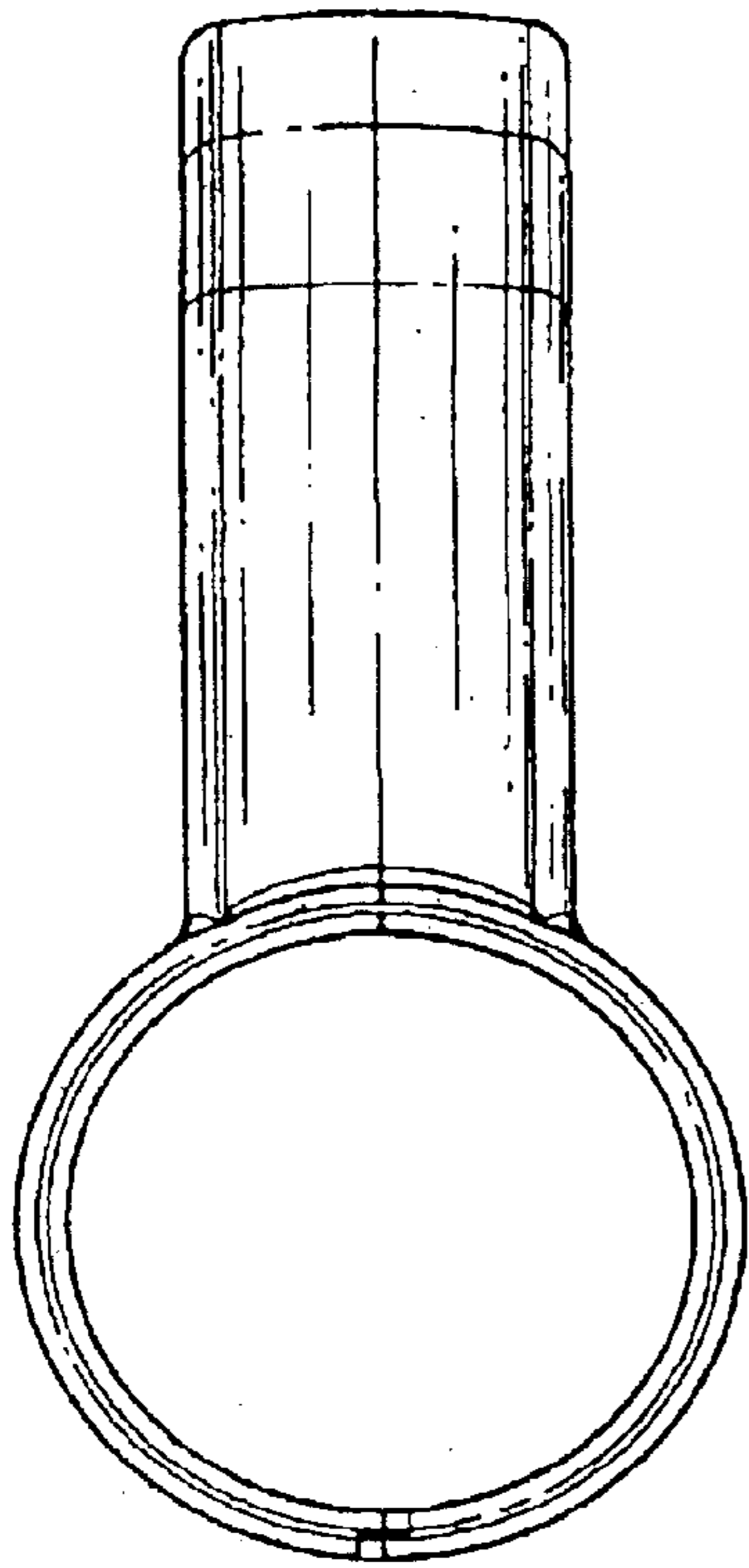

FIG. 10

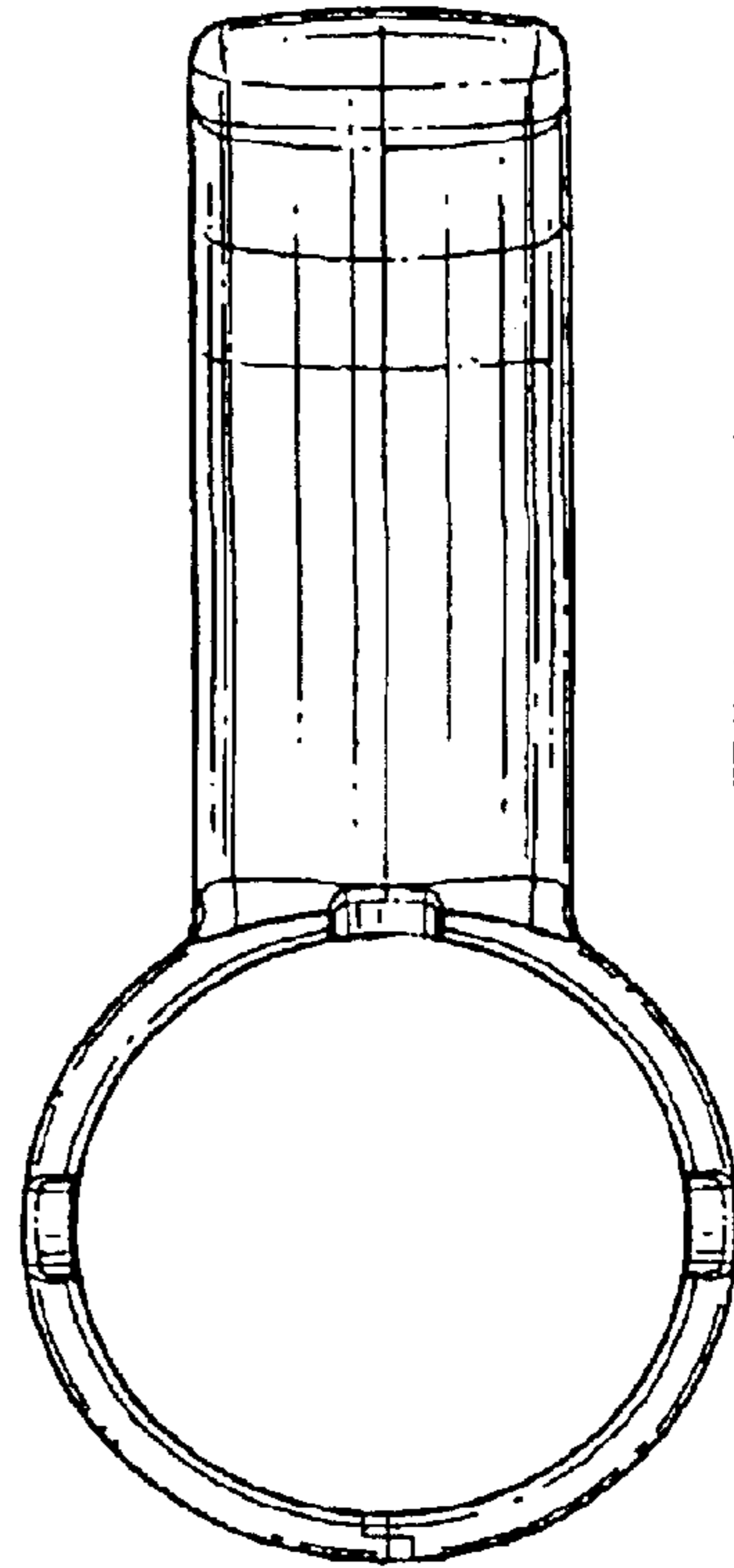

FIG. 11

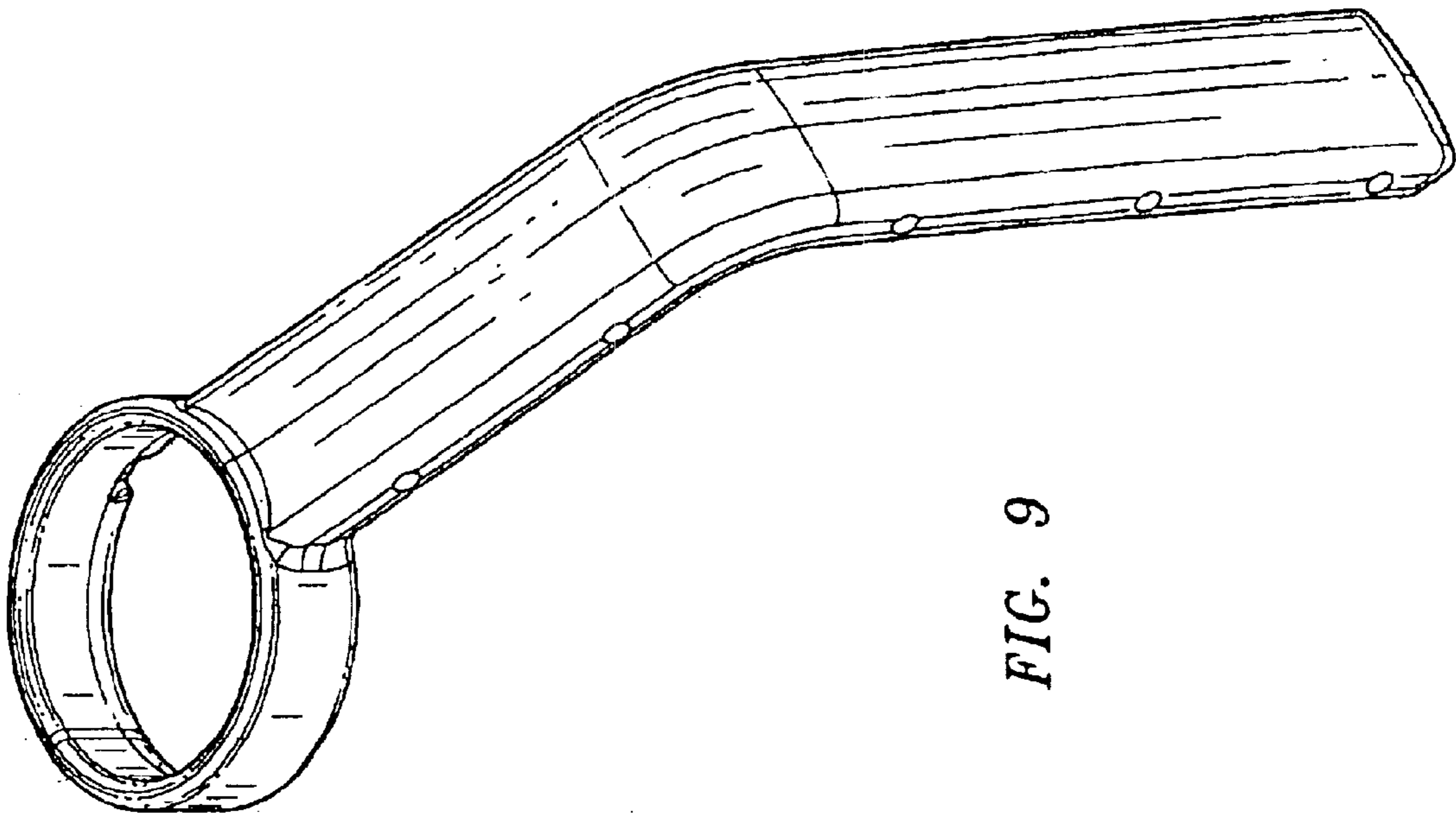

FIG. 9

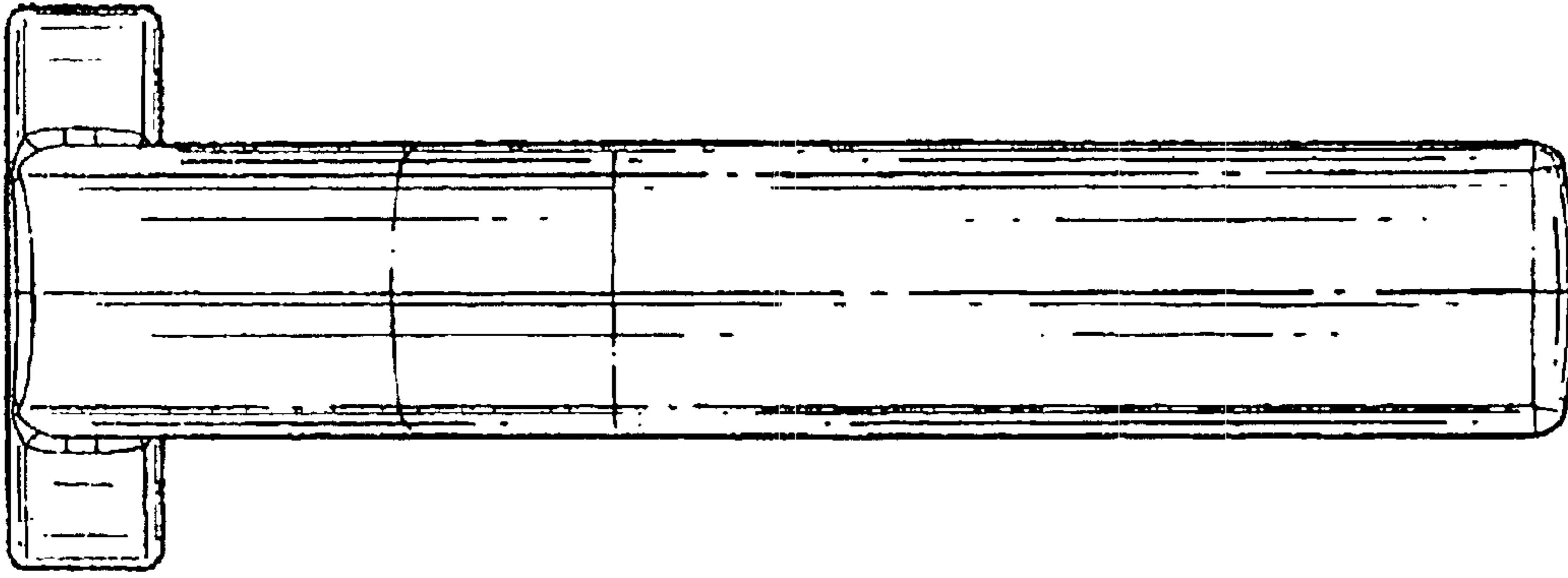

FIG. 13

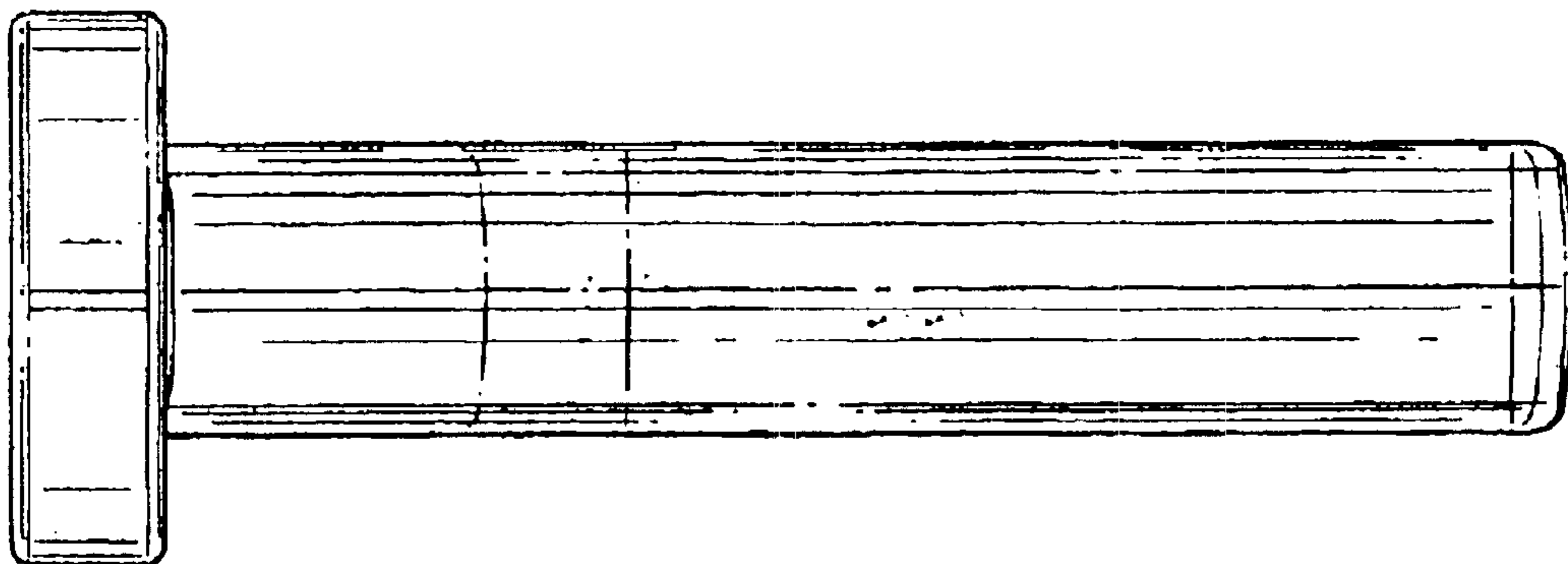

FIG. 12

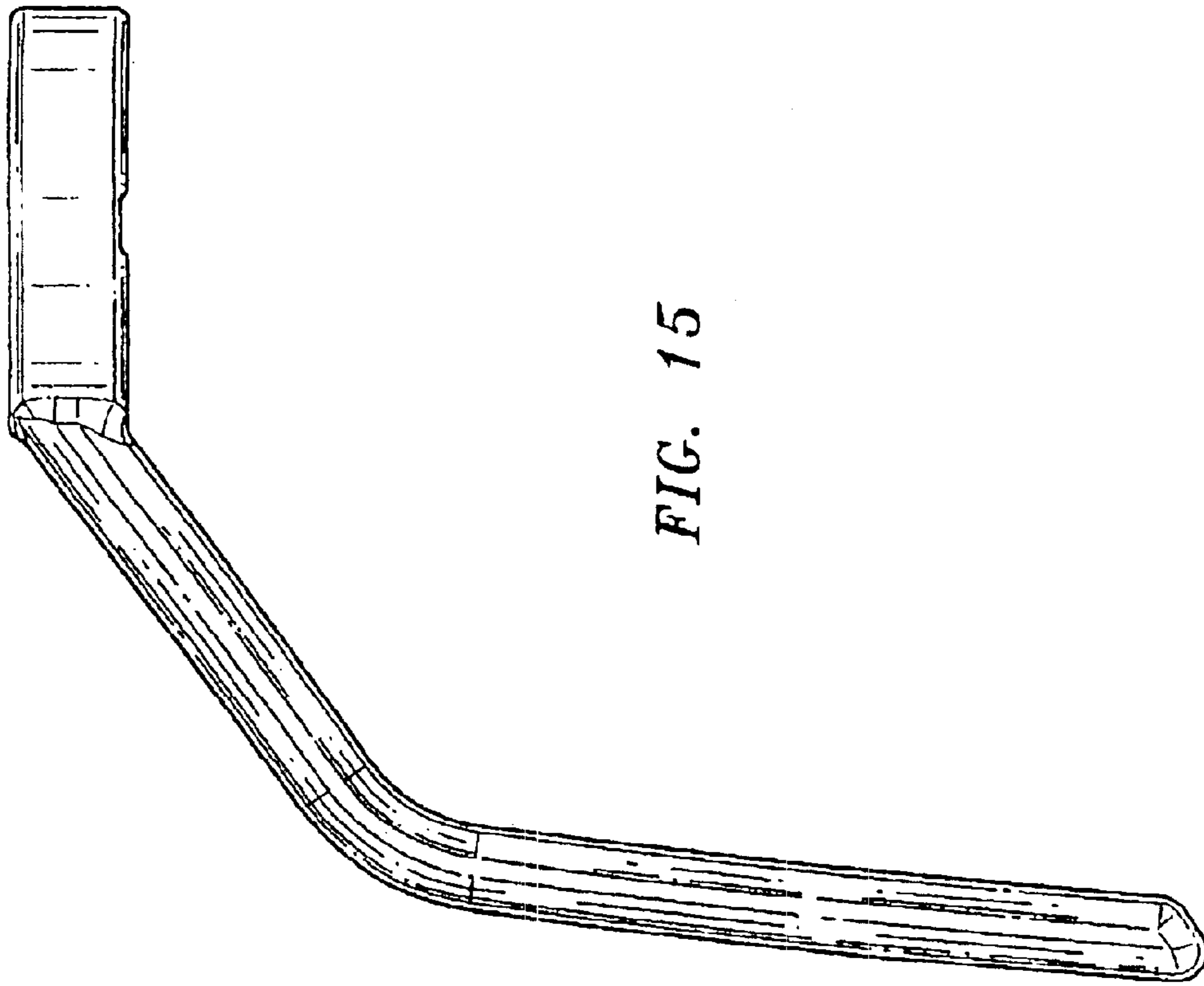

FIG. 15

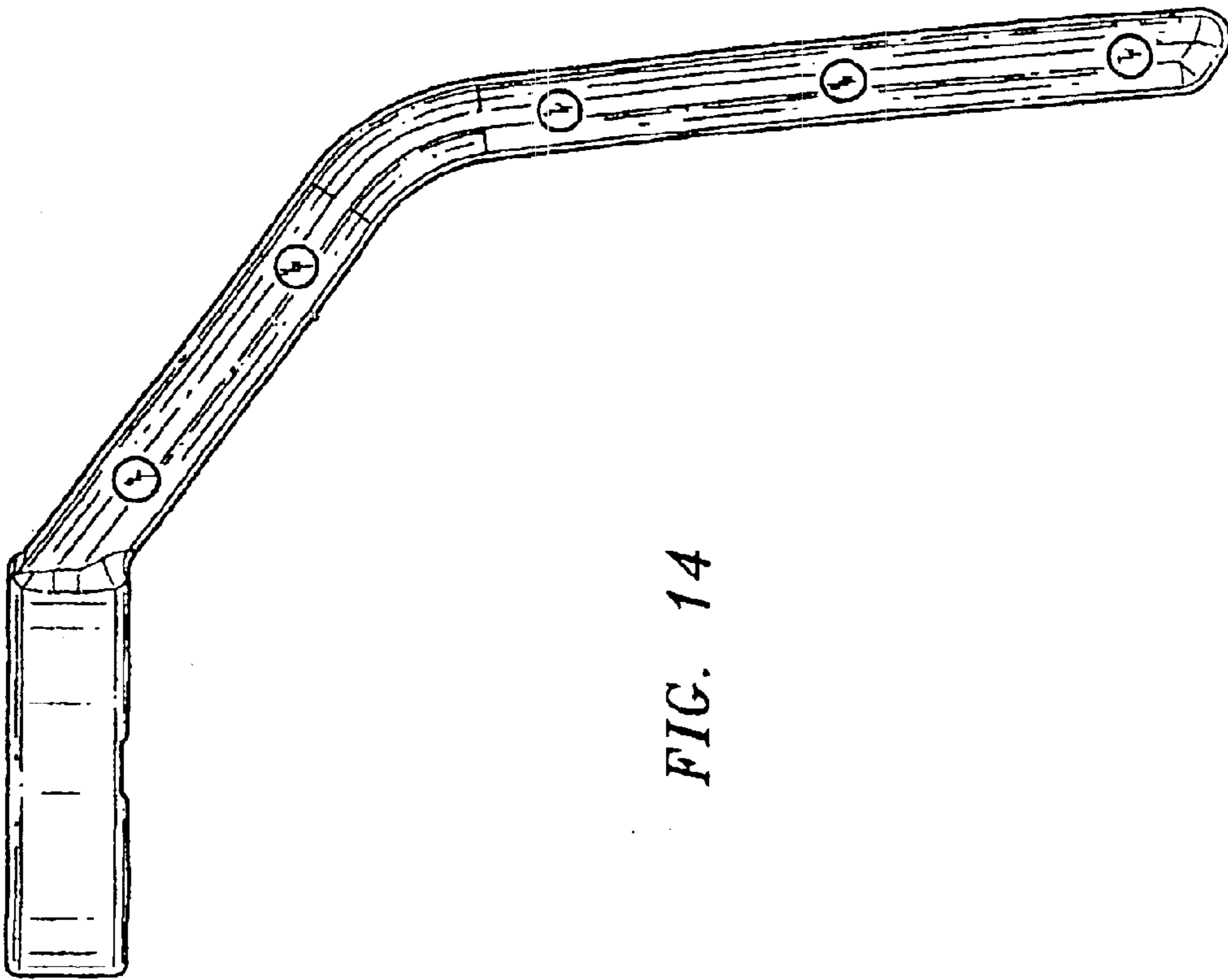

FIG. 14