



US00D496533S1

(12) **United States Design Patent**  
**Everitt et al.**

(10) **Patent No.:** **US D496,533 S**  
(45) **Date of Patent:** **\*\* Sep. 28, 2004**

(54) **SEAT ASSEMBLY FOR A MOTORCYCLE**

(74) *Attorney, Agent, or Firm*—Banner & Witcoff Ltd.

(75) Inventors: **Stephen Everitt**, London (GB); **David Minty**, London (GB); **Clive Kilford**, London (GB); **Nicholas Carpenter**, London (GB)

(57) **CLAIM**

The ornamental design for a seat assembly for a motorcycle, as shown and described.

(73) Assignee: **Brumby Corporation Ltd.**, Isle of Man (GB)

**DESCRIPTION**

(\*\*) Term: **14 Years**

FIG. 1 is a side elevational view of one side of a seat assembly for a motorcycle showing our new design, the opposite side being a mirror image thereof;

(21) Appl. No.: **29/172,100**

FIG. 2 is a top plan view thereof;

(22) Filed: **Dec. 6, 2002**

FIG. 3 is a bottom plan view thereof;

(30) **Foreign Application Priority Data**

FIG. 4 is a front elevational view thereof;

Jun. 7, 2002 (GB) ..... 3004189

FIG. 5 is a rear elevational view thereof;

(51) **LOC (7) Cl.** ..... **06-01**

FIG. 6 is a top, front perspective view thereof;

(52) **U.S. Cl.** ..... **D6/354**

FIG. 7 is a rear perspective view thereof;

(58) **Field of Search** ..... D12/110, 114,  
D12/184–186; 180/219; 280/152.1–152.3,  
160.1, 848, 852; 293/102–105; 297/195.1,  
215.16

FIG. 8 is a bottom, rear perspective view thereof;

FIG. 9 is a top plan view thereof on a reduced scale, shown in position of use on a motorcycle, which is shown in broken lines for illustrative purposes only and forms no part of the claimed design;

(56) **References Cited**

**U.S. PATENT DOCUMENTS**

FIG. 10 is a side elevational view of FIG. 9;

D234,103 S \* 1/1975 Hanagan ..... D6/354

FIG. 11 is a top, front perspective view of FIG. 9;

**OTHER PUBLICATIONS**

FIG. 12 is a rear perspective view of FIG. 9; and,

Cycle World Jun. 1999, seat unit shown in center of p. 92.\*

FIG. 13 is a rear elevational view of FIG. 9.

\* cited by examiner

*Primary Examiner*—Alan P. Douglas

**1 Claim, 13 Drawing Sheets**

*Assistant Examiner*—Linda Brooks

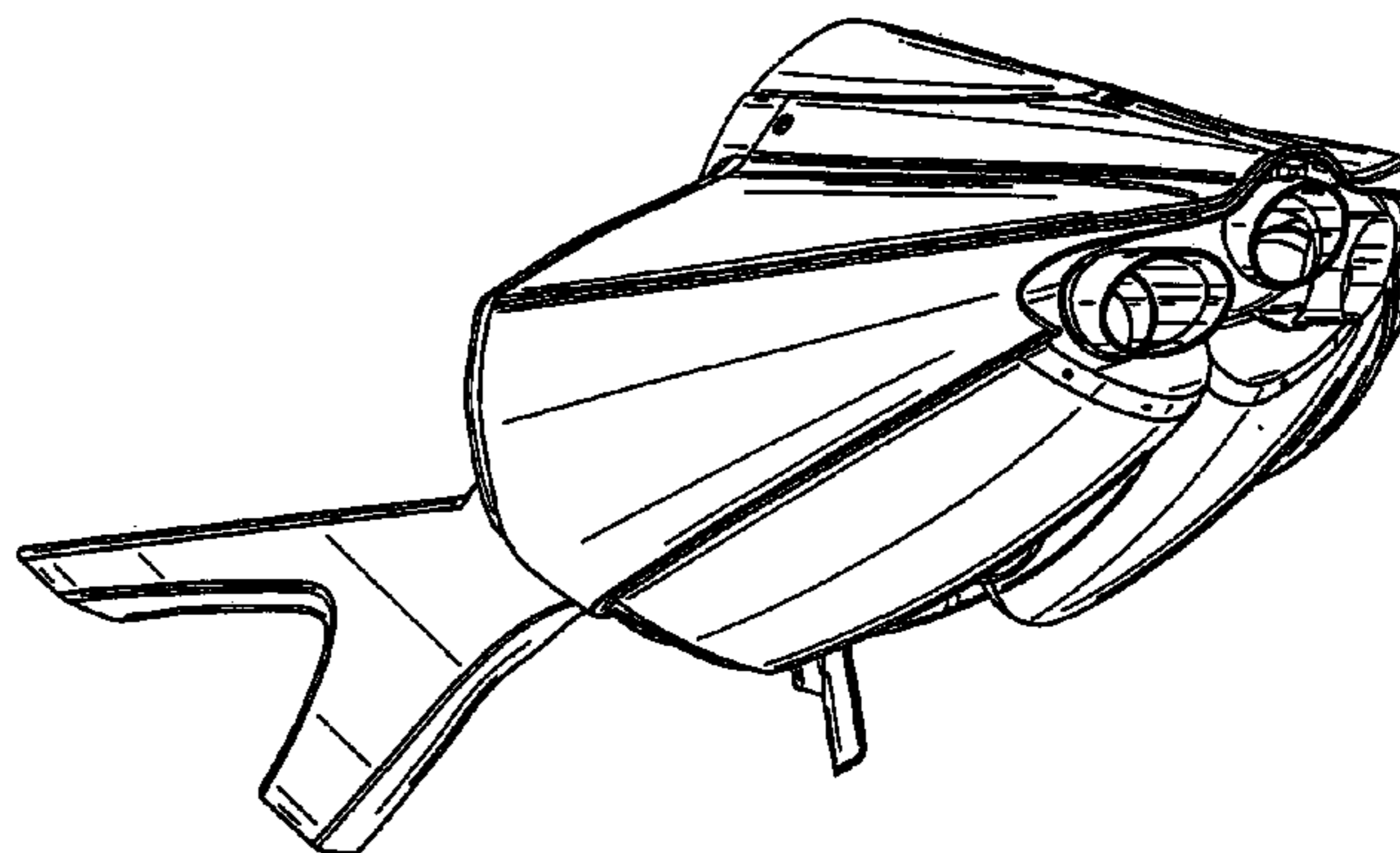
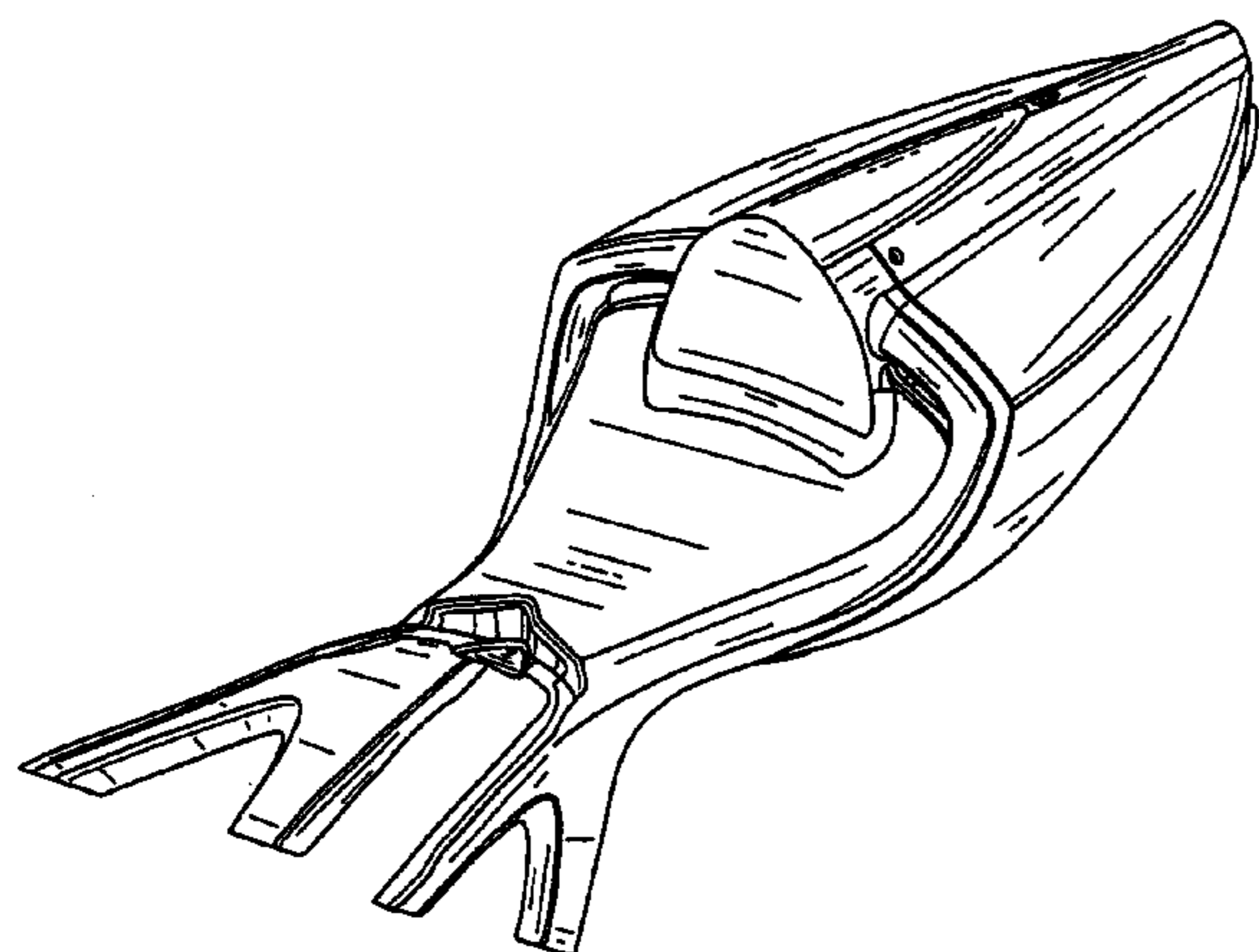

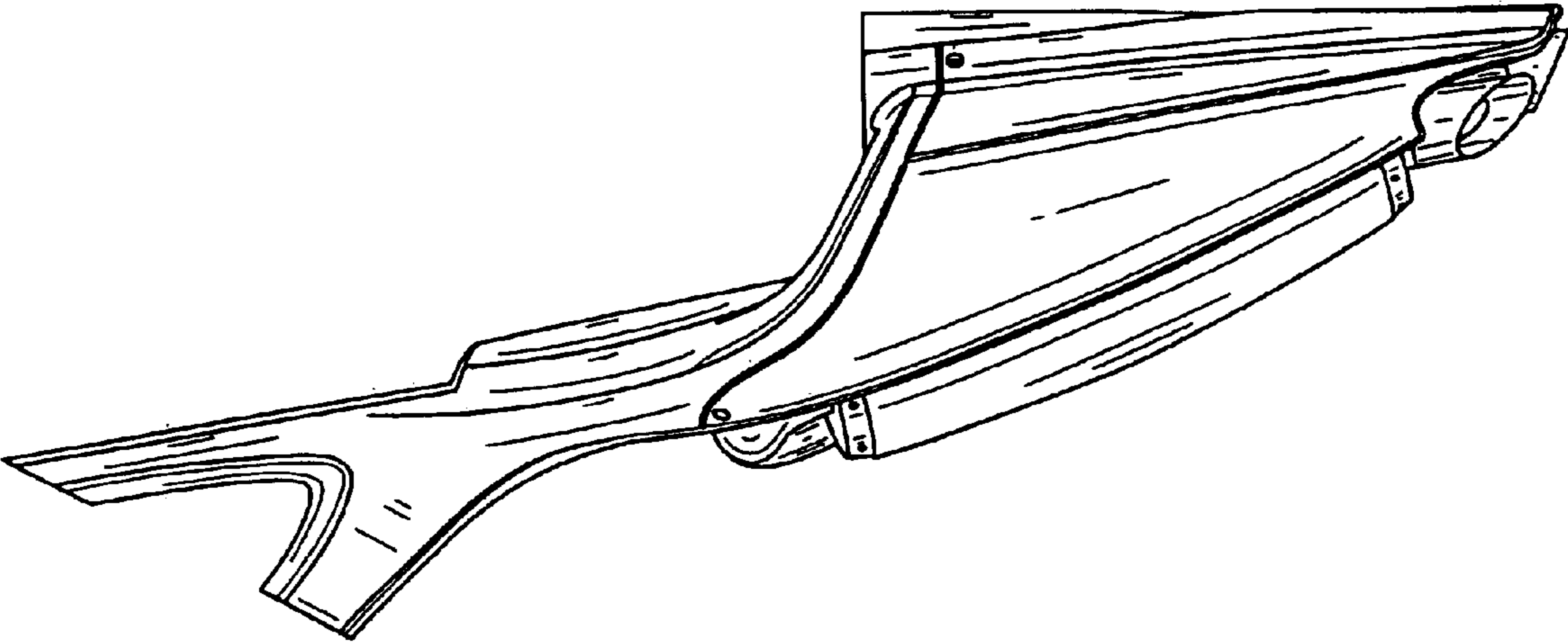

FIG. 1

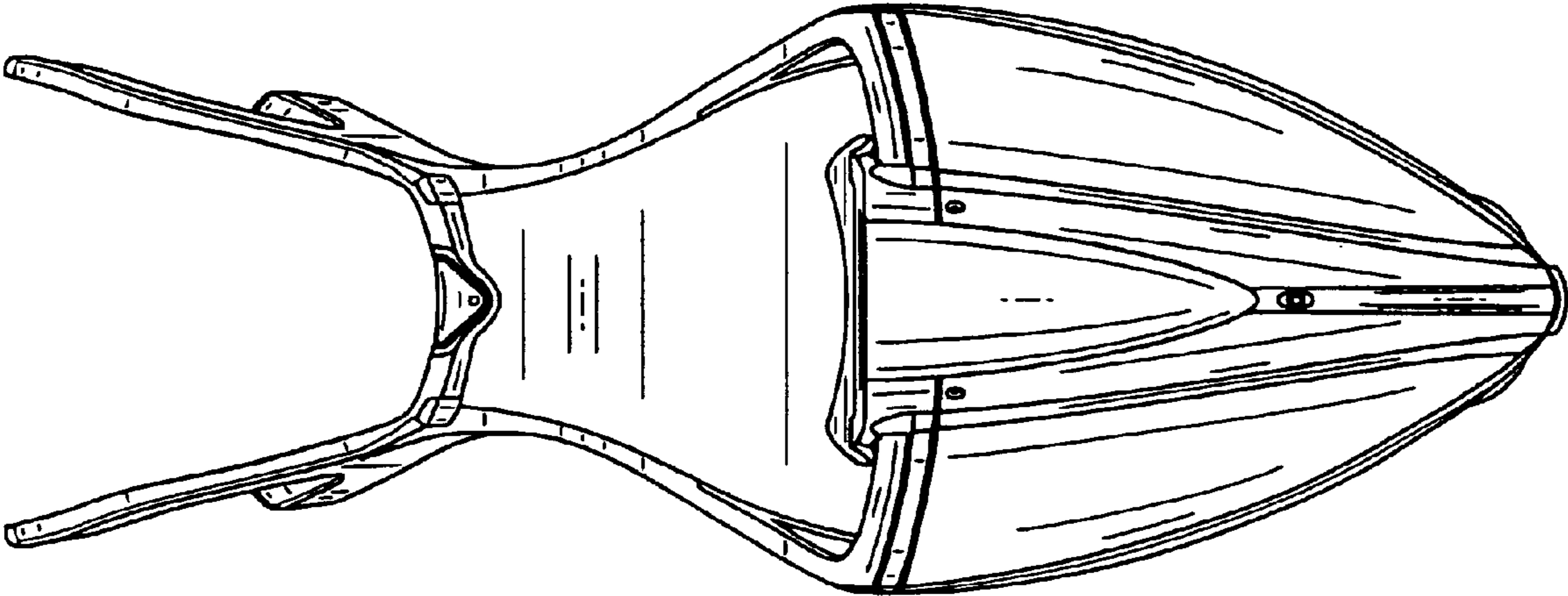

FIG. 2

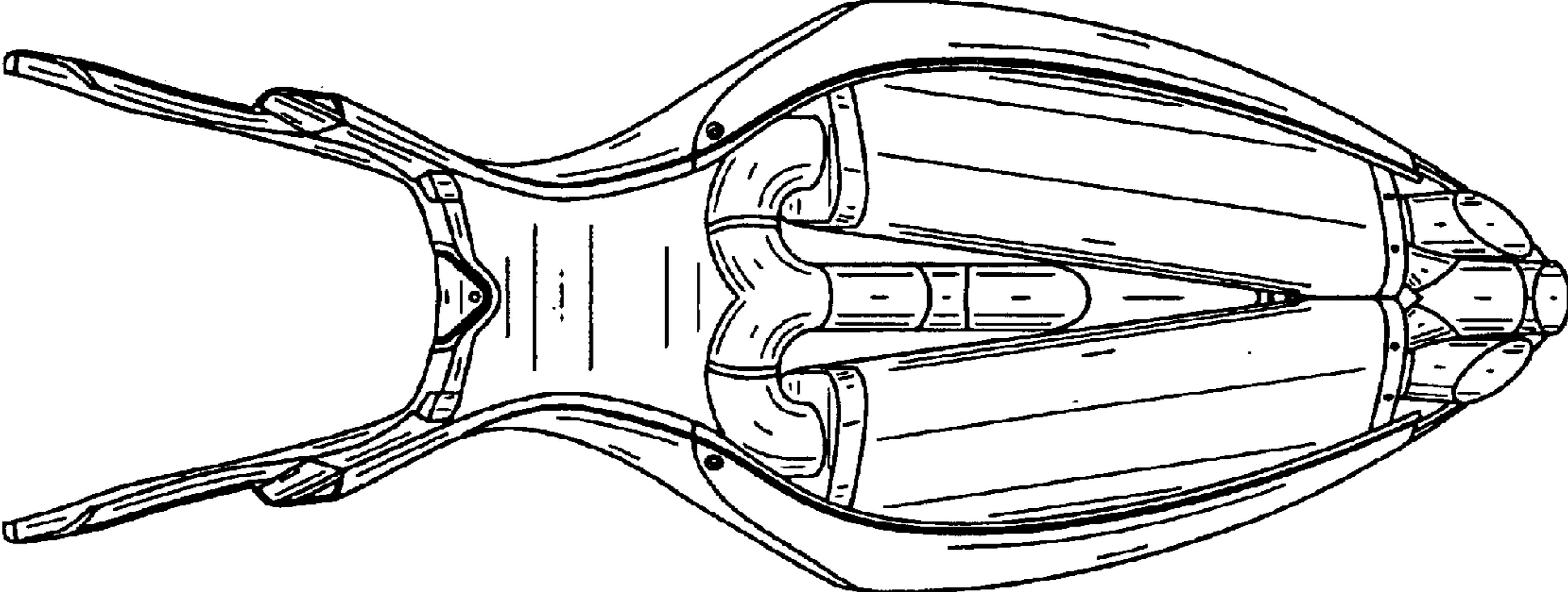

FIG. 3

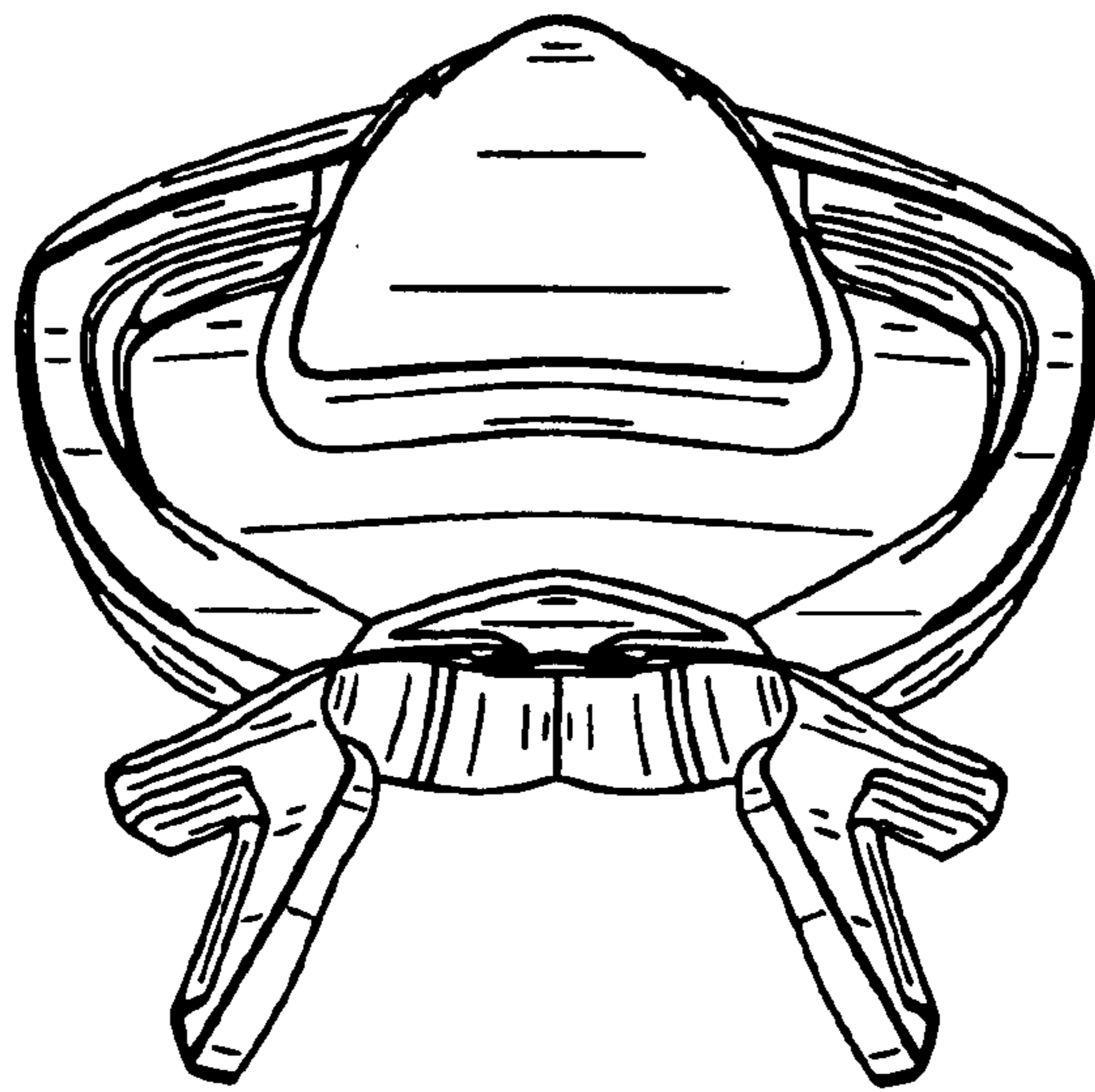

FIG. 4

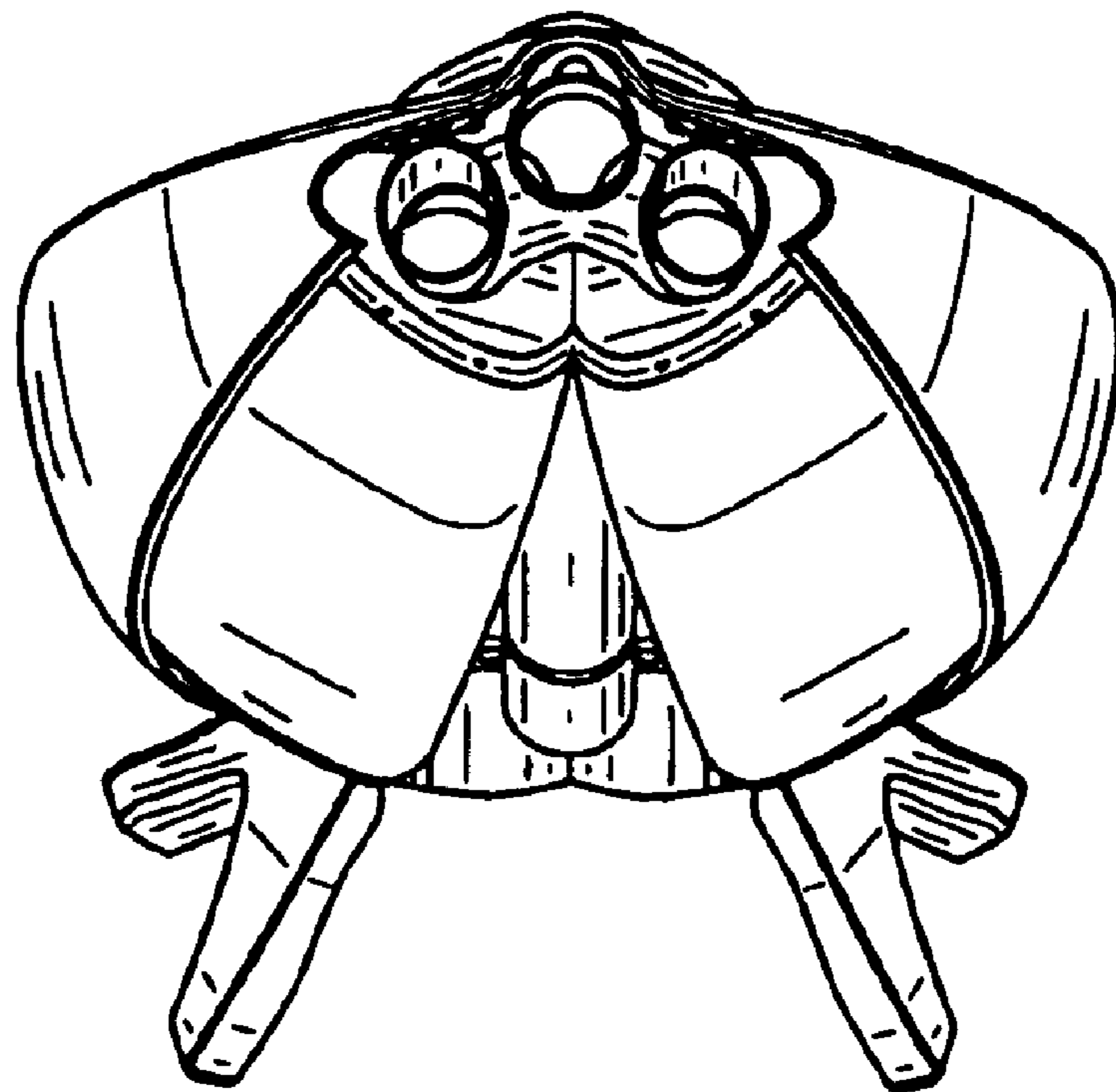

FIG. 5



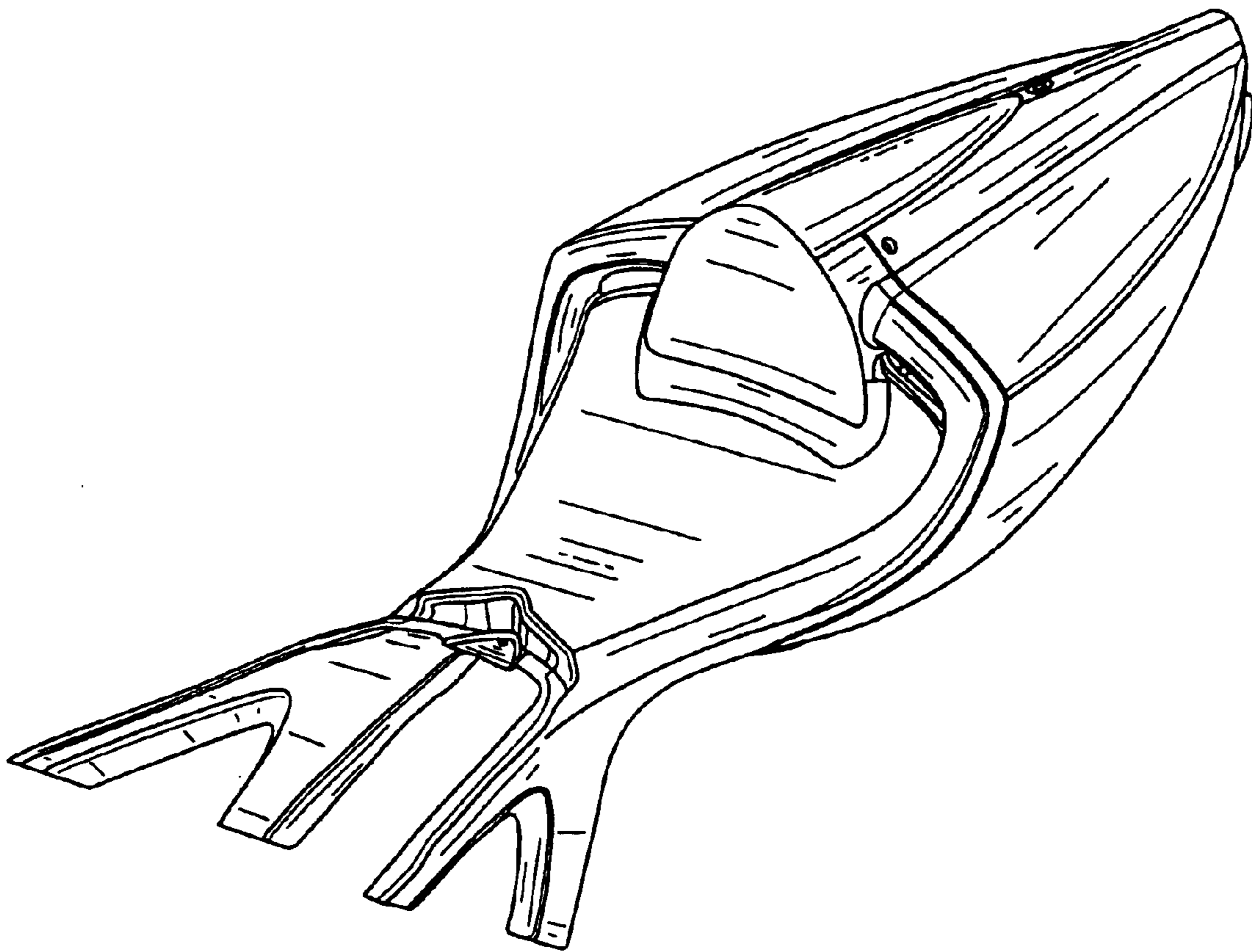

FIG. 6

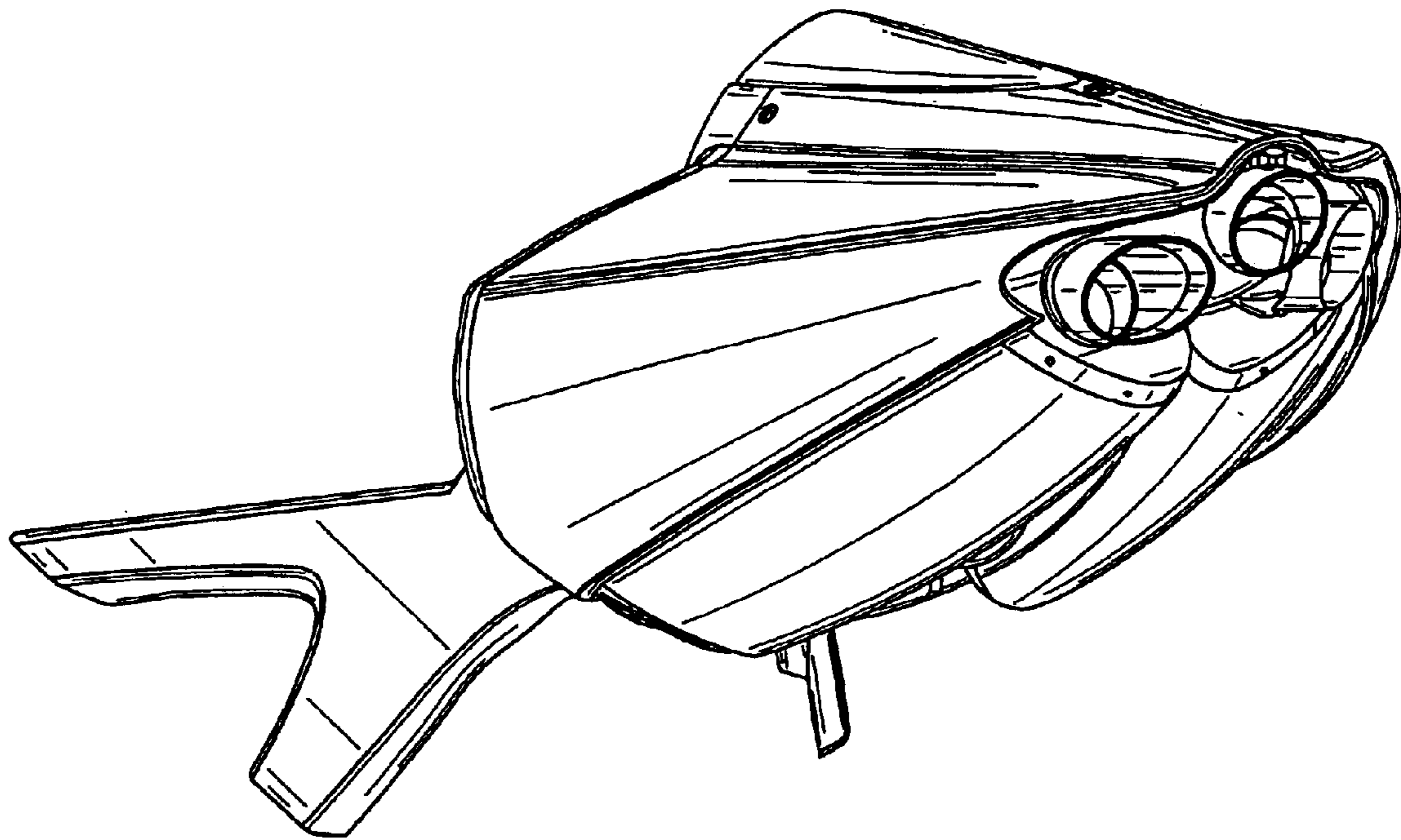

FIG. 7



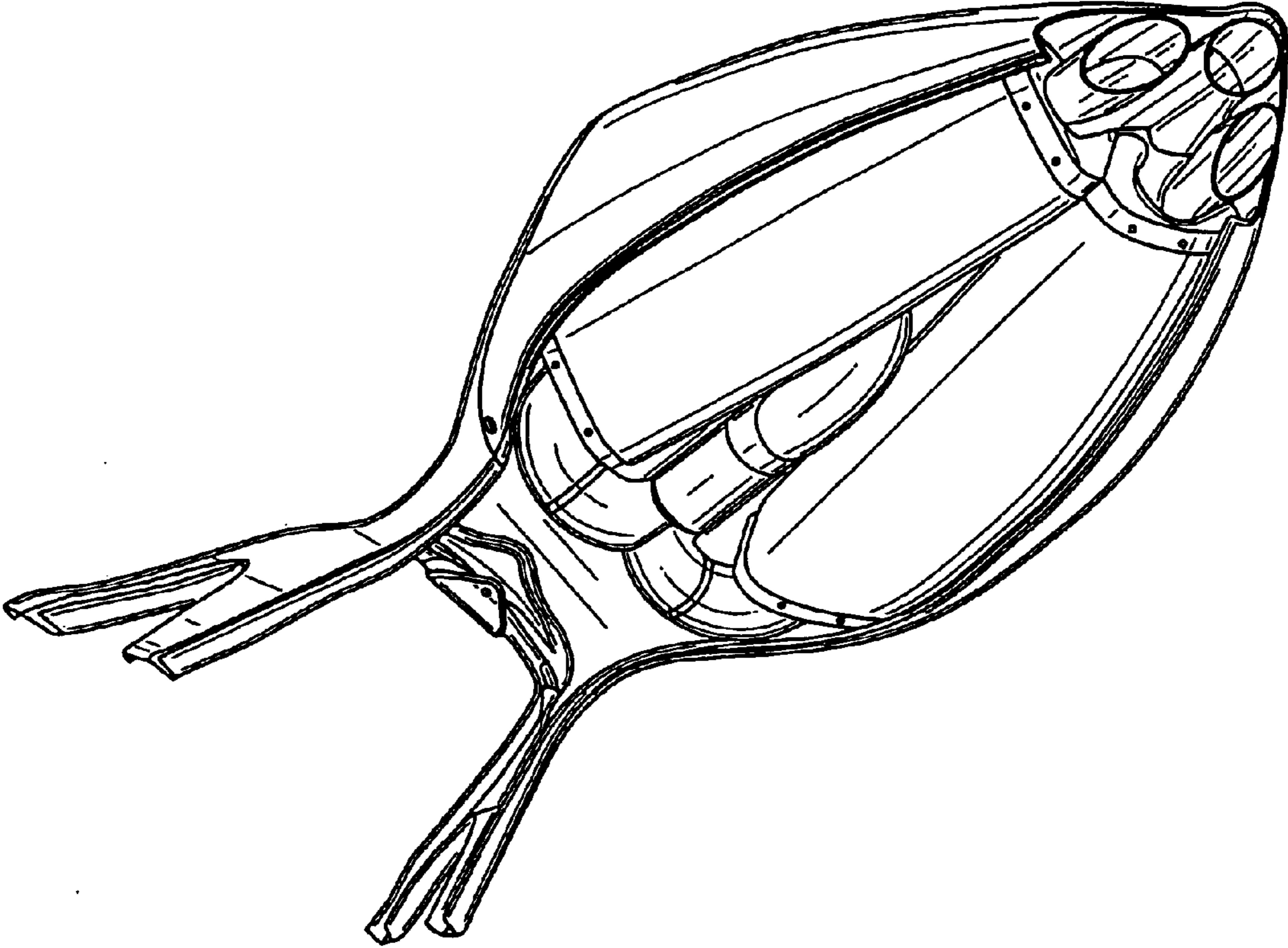

FIG. 8

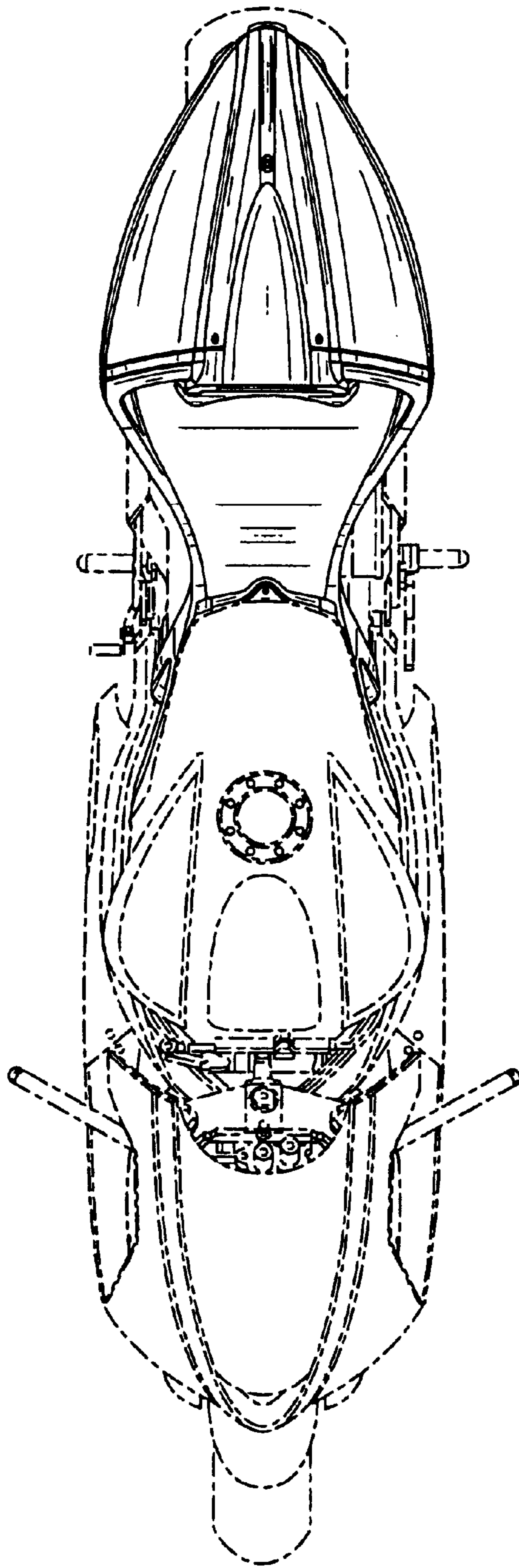

FIG. 9

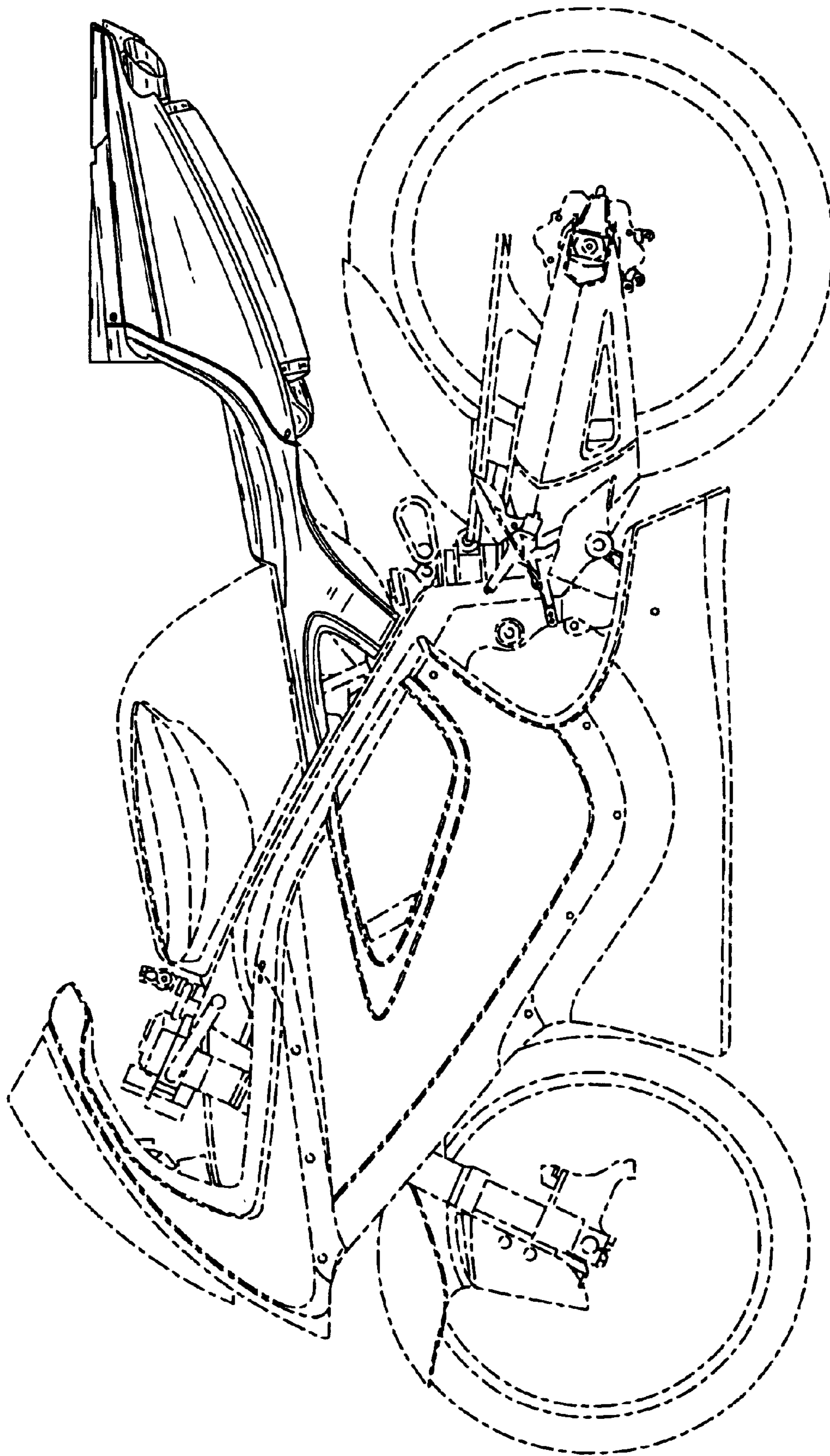

FIG. 10

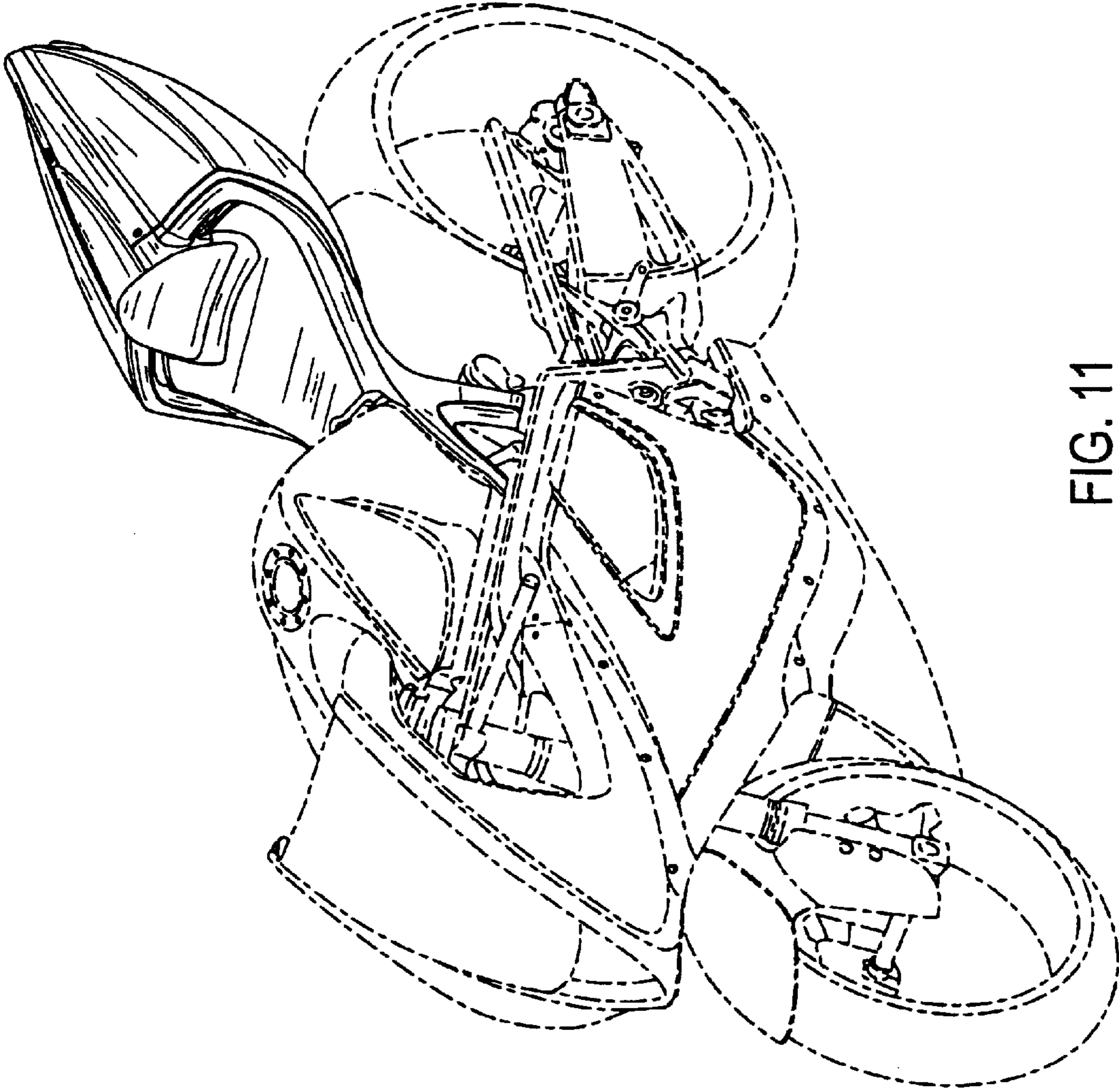

FIG. 11



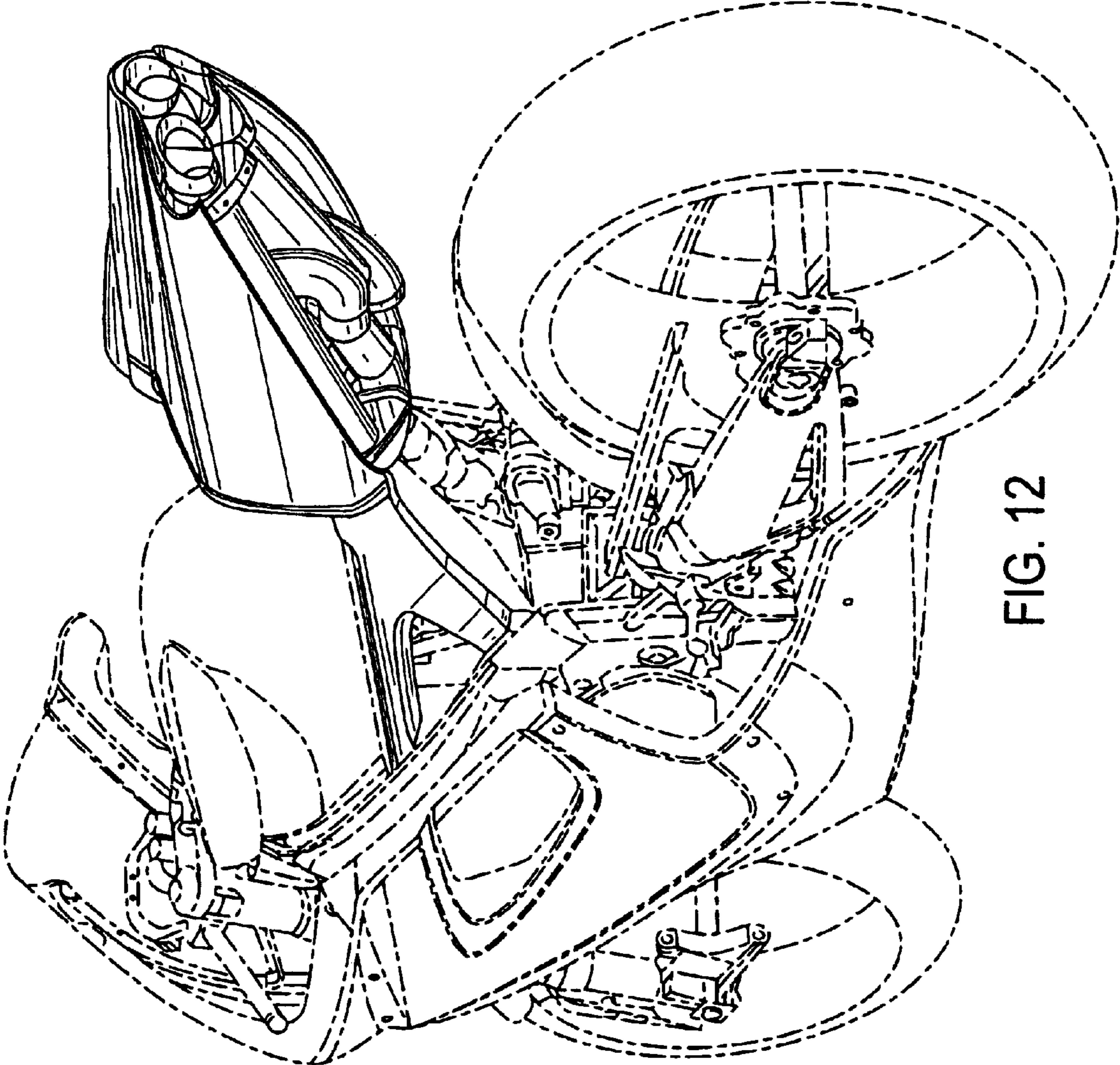

FIG. 12

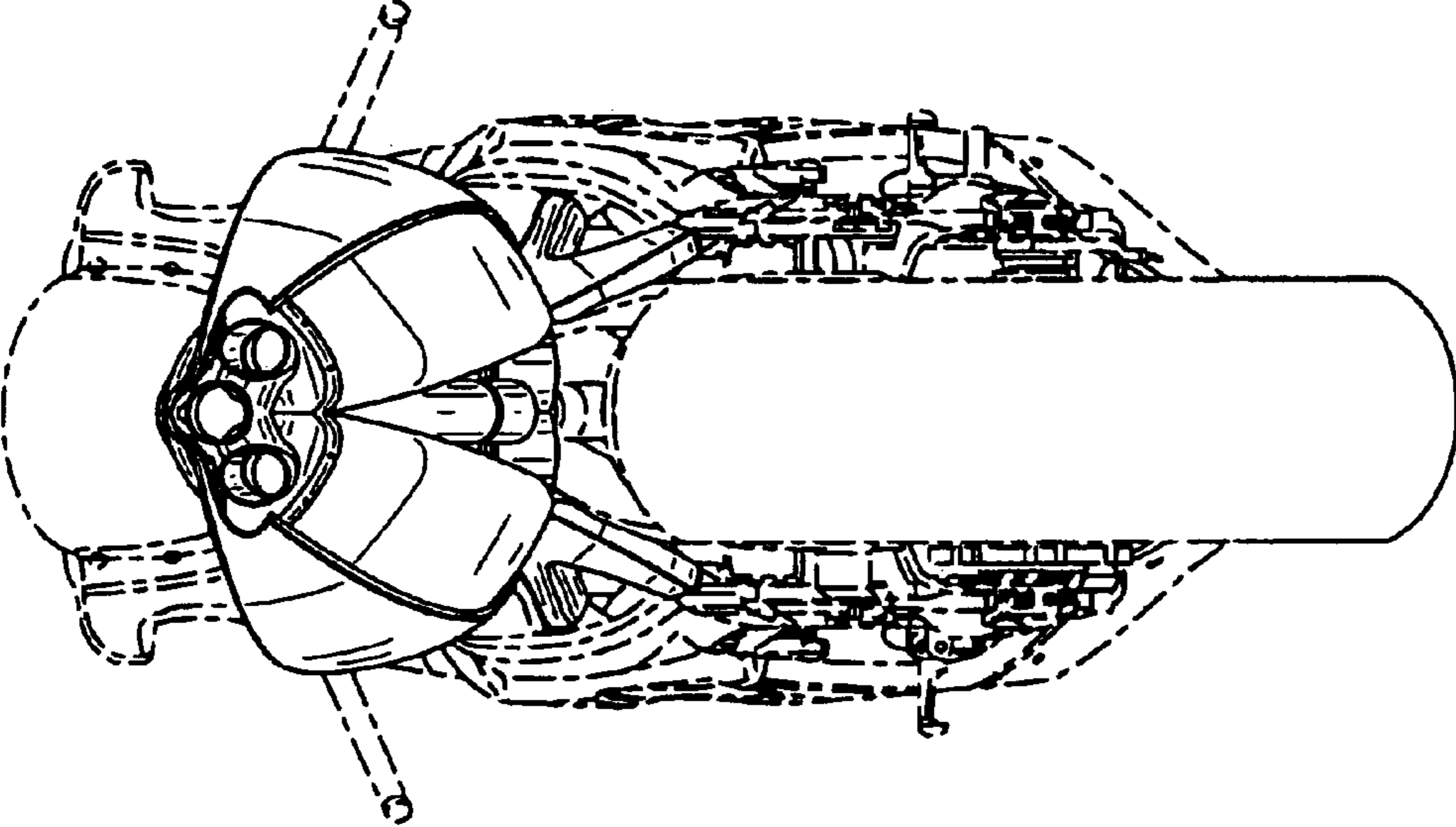

FIG. 13