

US00D496501S1

(12) **United States Design Patent** (10) **Patent No.:** **US D496,501 S**
Walter et al. (45) **Date of Patent:** **** Sep. 21, 2004**

(54) **DOMED CAT LITTER BOX**

D370,317 S * 5/1996 Kohus D30/161
D373,663 S * 9/1996 Walter D30/161

(75) Inventors: **Glen V. Walter**, Boxford, MA (US);
Benjamin Beck, Boston, MA (US);
David Harting, Needham, MA (US);
Douglas Marsden, Lynnfield, MA (US)

(73) Assignee: **Eleven, LLC**

(**) Term: **14 Years**

(21) Appl. No.: **29/138,692**

(22) Filed: **Mar. 16, 2001**

(51) **LOC (7) Cl.** **30-99**

(52) **U.S. Cl.** **D30/161**

(58) **Field of Search** D30/108-119,
D30/161; 119/28.5, 703, 706, 416, 474,
452-456, 459, 467, 482, 436, 496-497,
500-502, 408, 410, 161, 165-170, 52.3,
57.8-57.9, 428-435; D6/551

(56) **References Cited**

U.S. PATENT DOCUMENTS

1,616,781 A	2/1927	Bugenhagen	
2,987,043 A	6/1961	Spindler	
3,147,736 A	9/1964	Daniel	
D200,298 S	* 2/1965	Daniel	D30/117
3,172,392 A	3/1965	Schultz	
D215,306 S	9/1969	Hoff	
D246,540 S	11/1977	Burleson	
D250,051 S	10/1978	Spinks	
D274,760 S	* 7/1984	Henderson	D30/108
D288,733 S	* 3/1987	Welker	D30/108
D288,734 S	* 3/1987	Wallace et al.	D30/109
4,802,443 A	* 2/1989	Denmark	119/482
D308,589 S	6/1990	Shay	D30/161
D317,665 S	* 6/1991	Marshall	D30/108
5,092,277 A	3/1992	Baillie et al.	119/165
5,195,464 A	3/1993	Mutter	119/165
5,218,930 A	6/1993	Casmira	119/165
5,220,886 A	6/1993	Hyde	119/165
5,259,340 A	11/1993	Arbogast	119/166
5,329,878 A	7/1994	McCauley	119/165
5,329,879 A	7/1994	Walton	119/166
5,361,725 A	11/1994	Baillie et al.	119/165
D360,709 S	7/1995	Northrop et al.	D30/108

OTHER PUBLICATIONS

Bareto, A.F. et al., Federal Trademark Reg. No. 1,631,630, for: Pet Shelters, Jan. 15, 1991.

Dogloo, "How Does it Feel . . ." (Print Advertisement) *Pet Business*, Feb. 1995.

Doskocil, "Buying A Home Just Got Easier . . ." (Print Advertisement) *Pet Business* Feb. 1995.

Igloo Dog Homes, "Igloo Dog Homes" (Print Advertisement) see: Trademark File History, U.S. patent application Ser. No. 73/819,087, United States Patent and Trademark Office; Jul. 1987.

* cited by examiner

Primary Examiner—Cathy Anne MacCormac
(74) *Attorney, Agent, or Firm*—Lowrie, Lando & Anastasi, LLP

(57) **CLAIM**

The ornamental design for a domed cat litter box, as shown.

DESCRIPTION

FIG. 1 is a perspective view of the front and right side of a domed cat litter box showing our new design;
 FIG. 2 is a front elevational view thereof;
 FIG. 3 is a right side elevational view thereof, the left side being a mirror image;
 FIG. 4 is a rear elevational view thereof;
 FIG. 5 is a top plan view thereof;
 FIG. 6 is a bottom plan view thereof;
 FIG. 7 is a rear view of the dome top thereof;
 FIG. 8 is a front view of FIG. 7;
 FIG. 9 is a perspective view of FIG. 7;
 FIG. 10 is a left side view of FIG. 7;
 FIG. 11 is a rear perspective view of FIG. 7;
 FIG. 12 is a side view of the base;
 FIG. 13 is a cross-sectional view taken along line 13—13 in FIG. 12;
 FIG. 14 is a top view of FIG. 12; and,
 FIG. 15 is a perspective view of FIG. 12.
 The broken lines in FIGS. 2-11 are for illustrative purposes only and form no part of the claimed design.

1 Claim, 11 Drawing Sheets

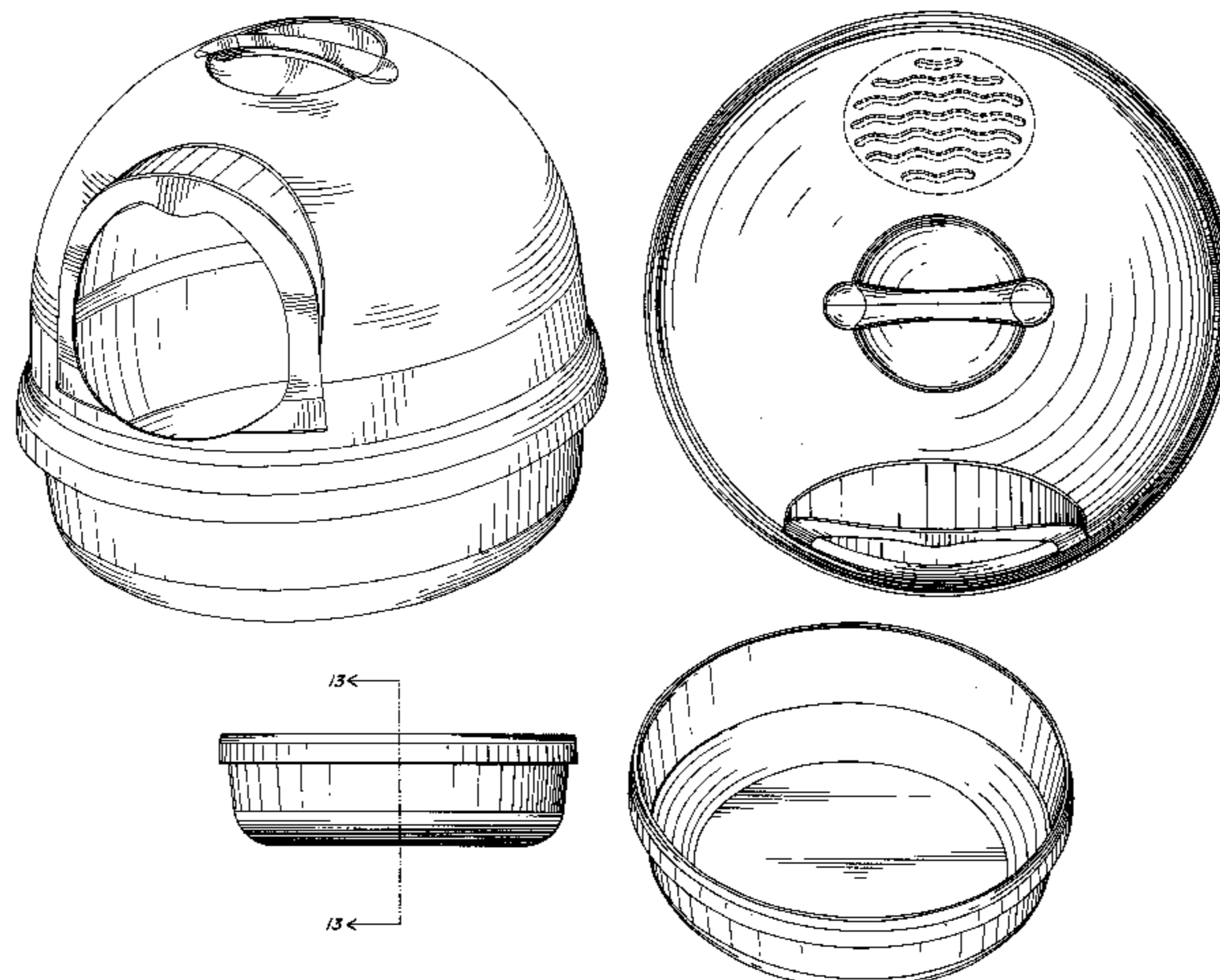

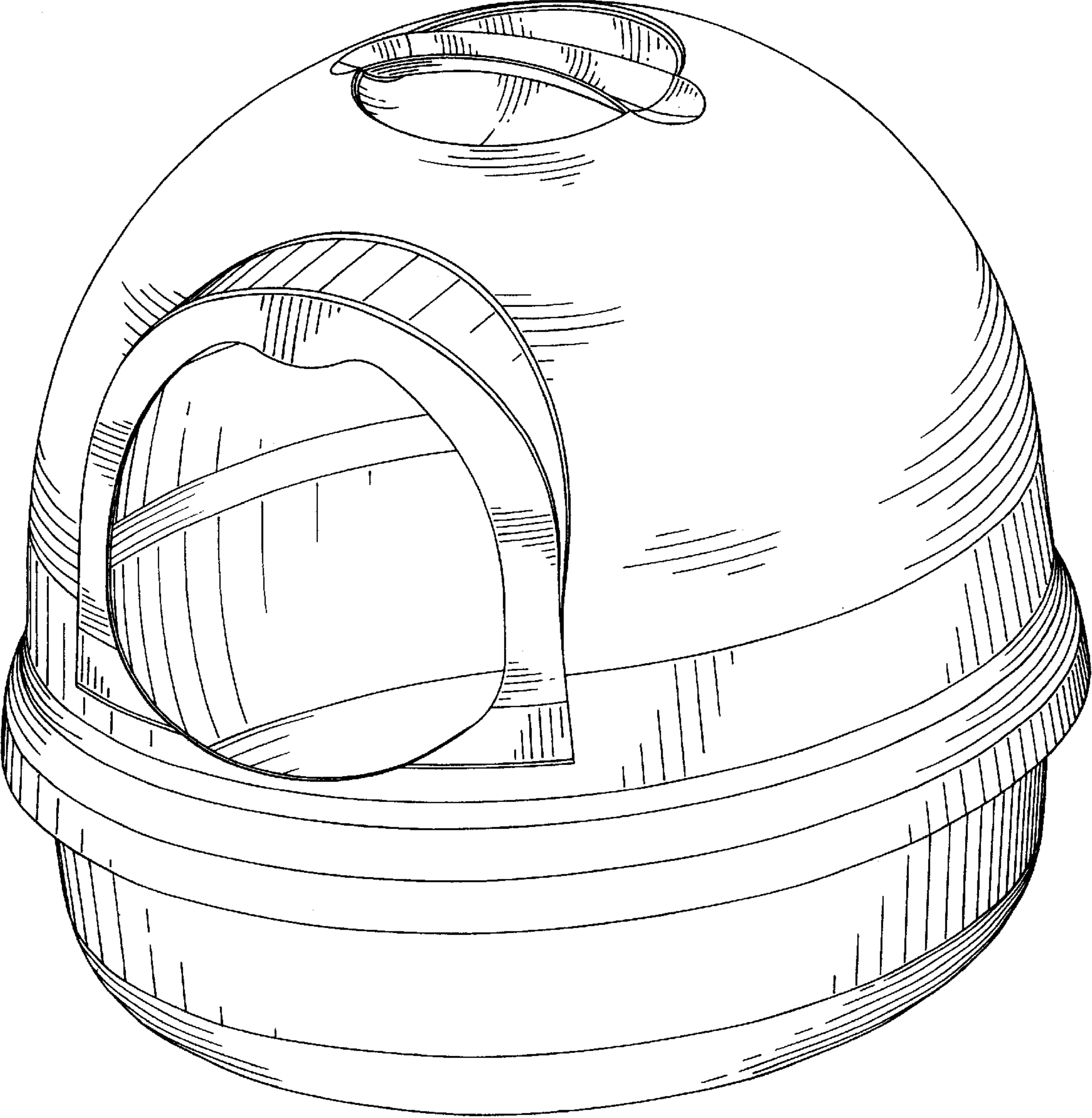

FIG. 1

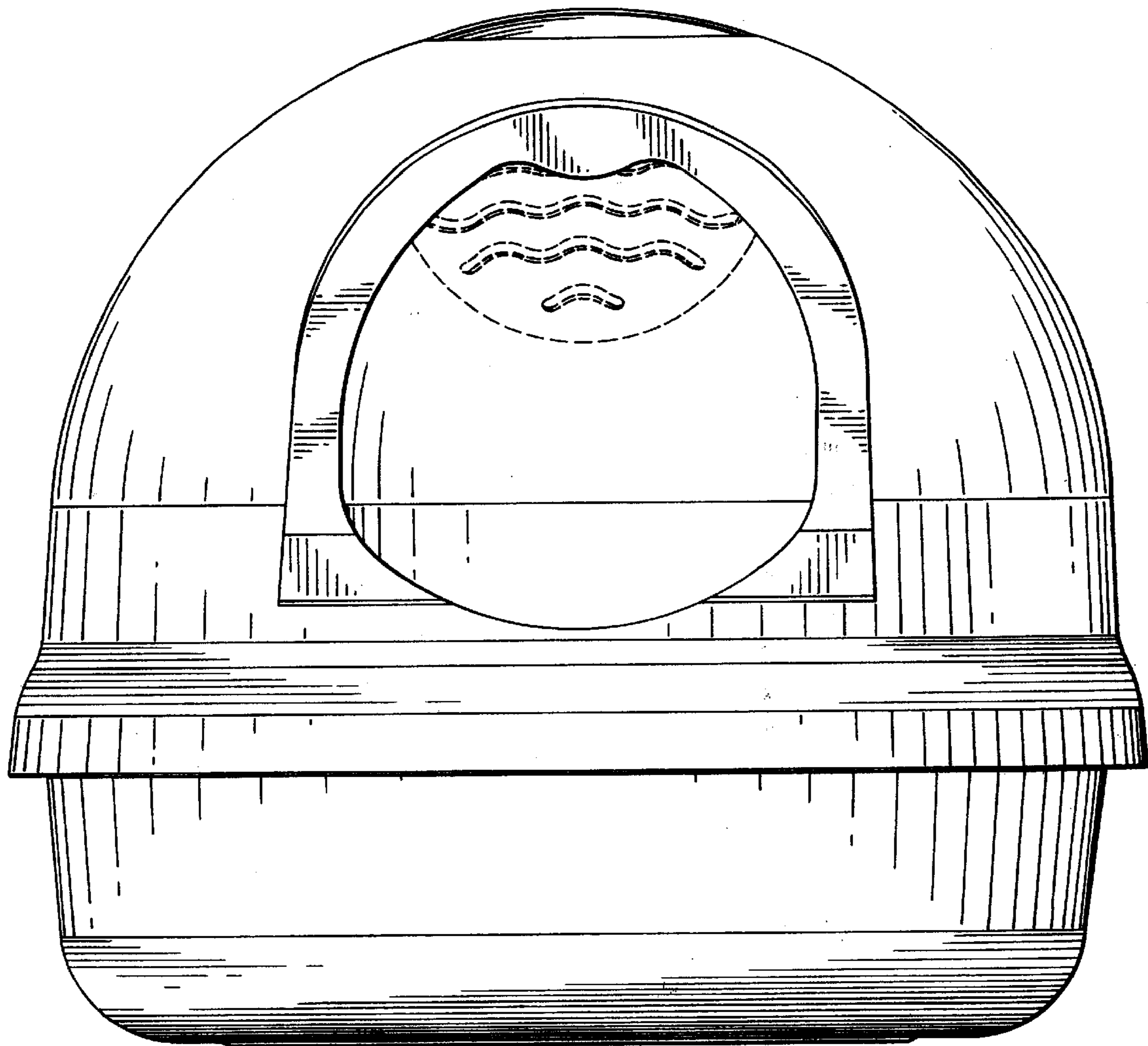

FIG. 2

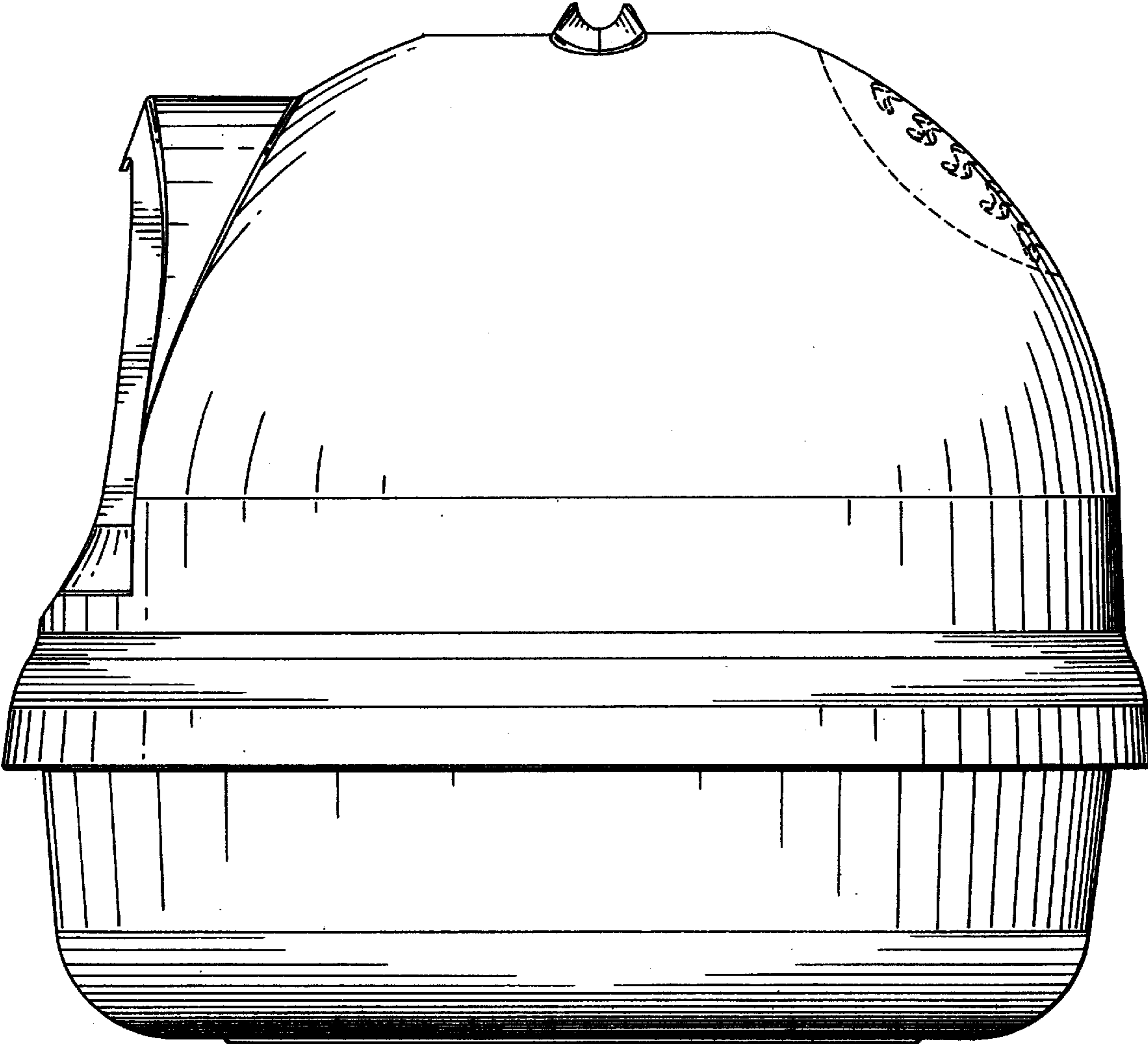

FIG. 3

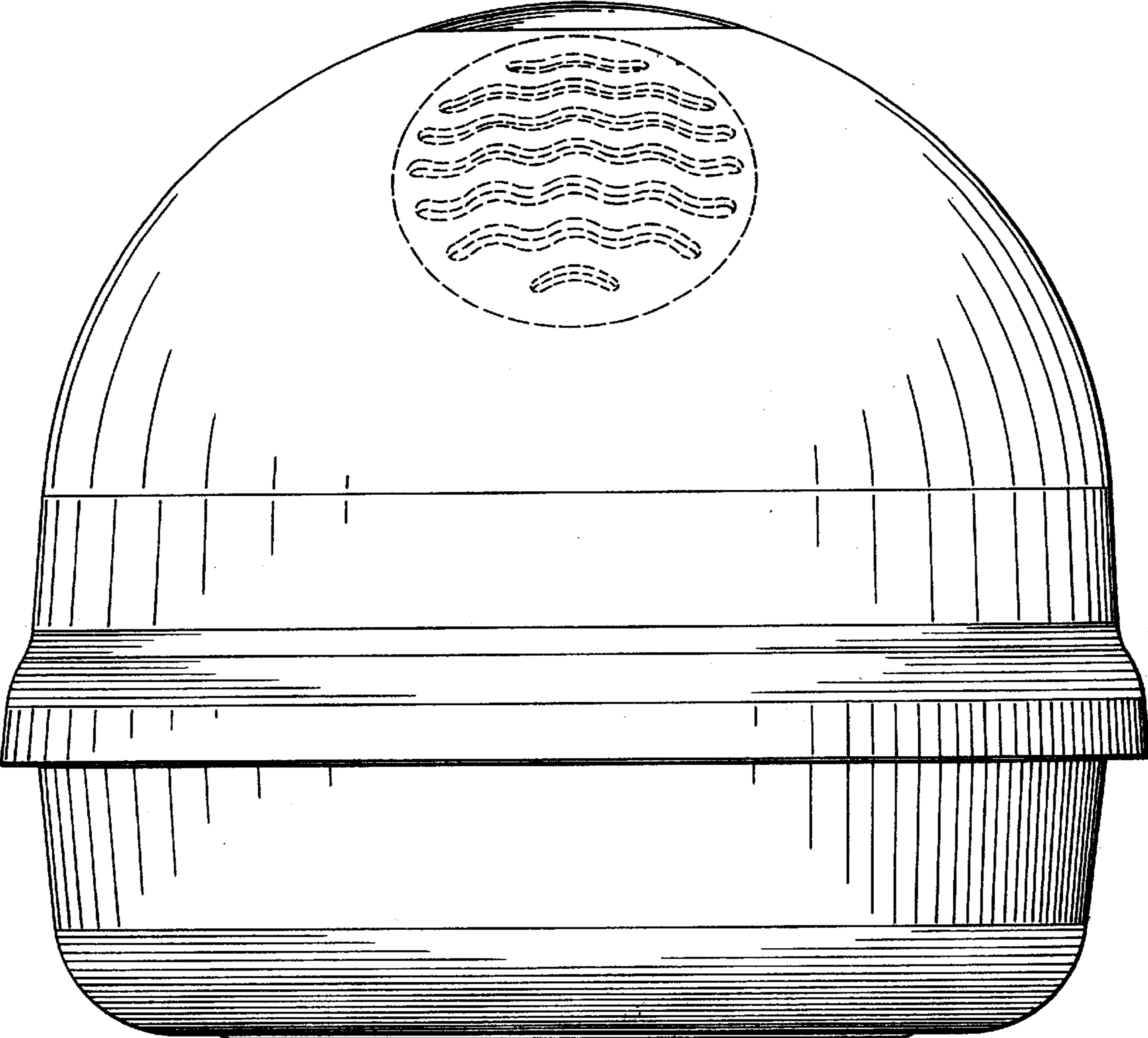

FIG. 4

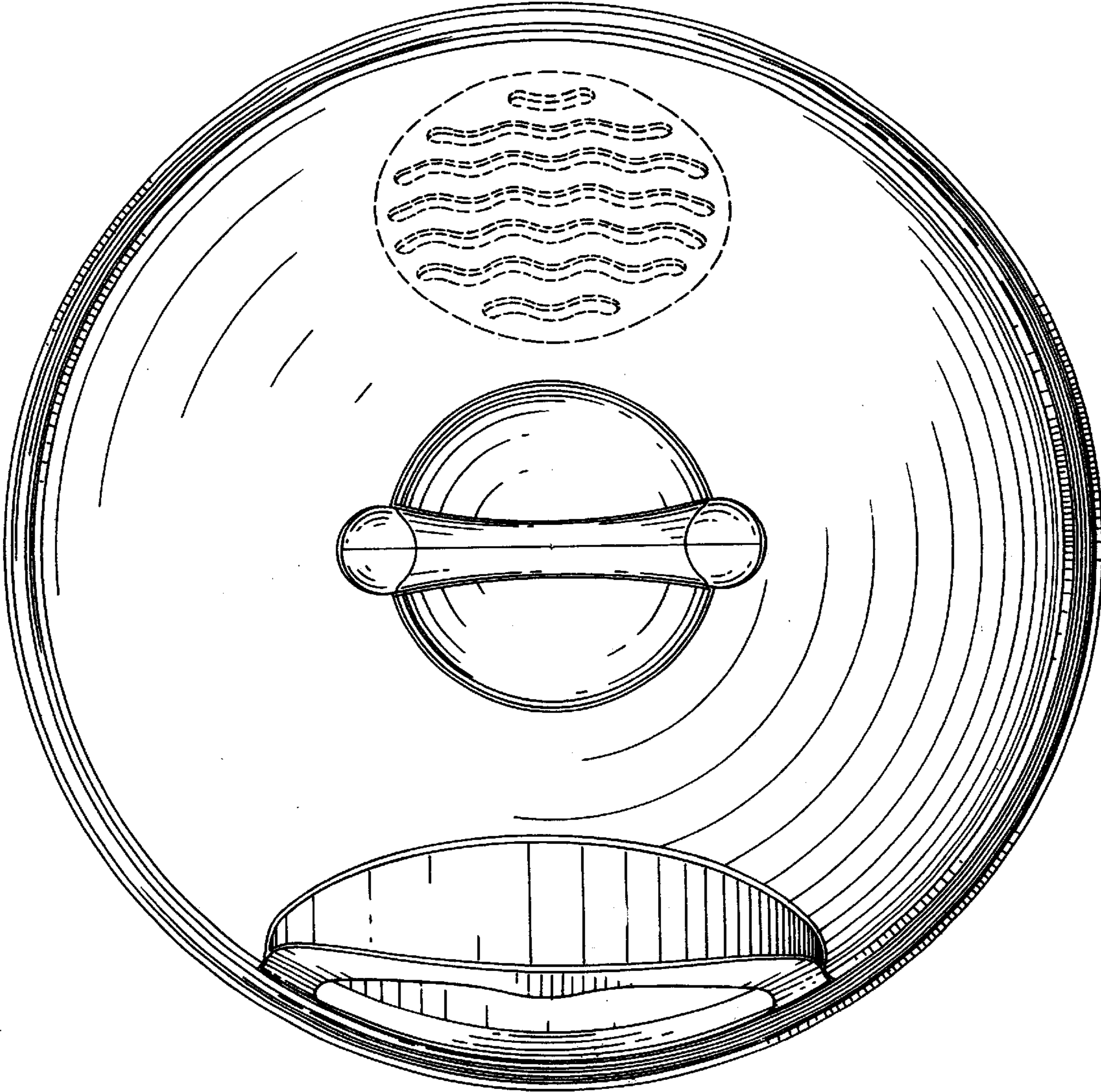

FIG. 5

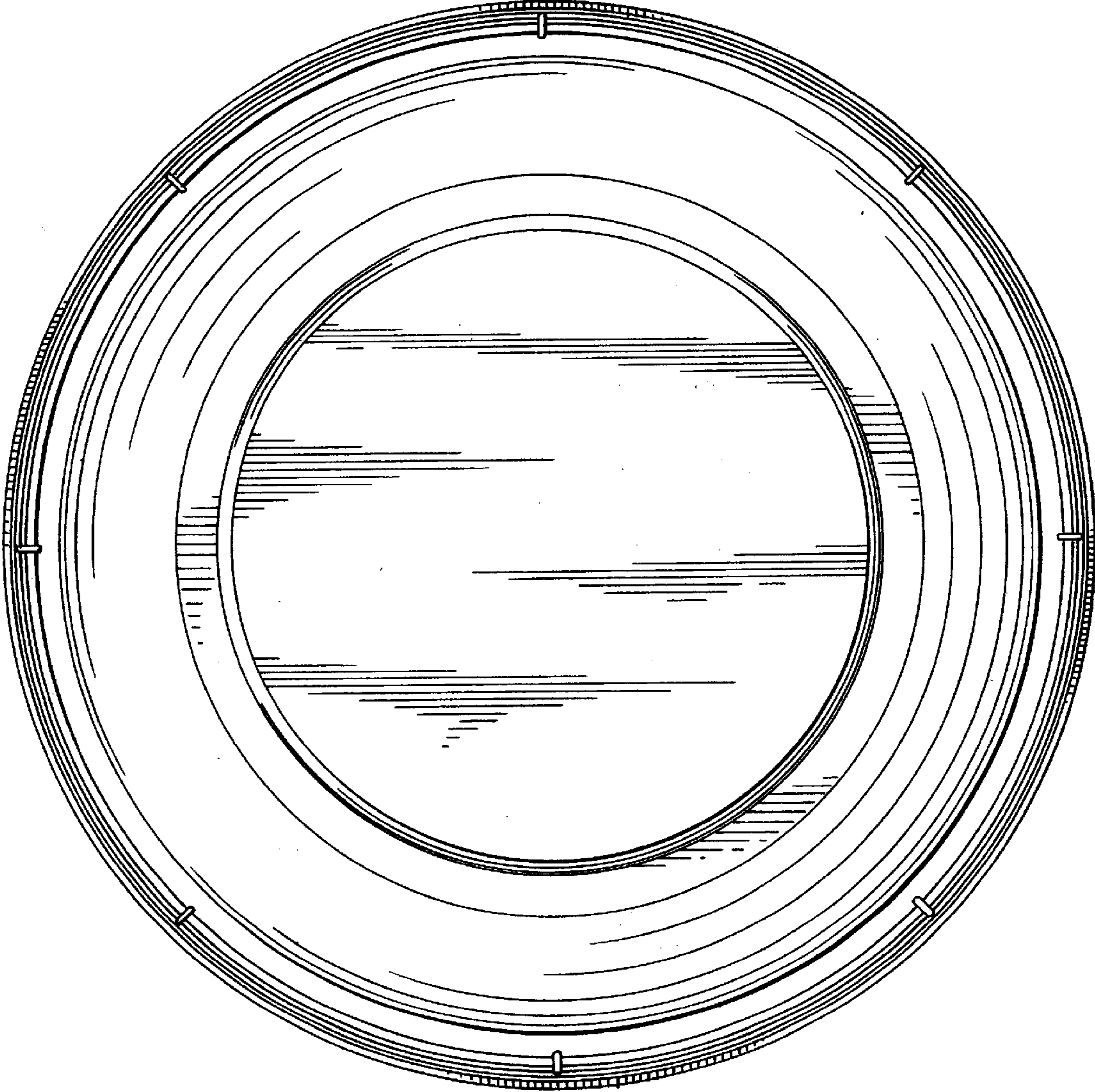

FIG. 6

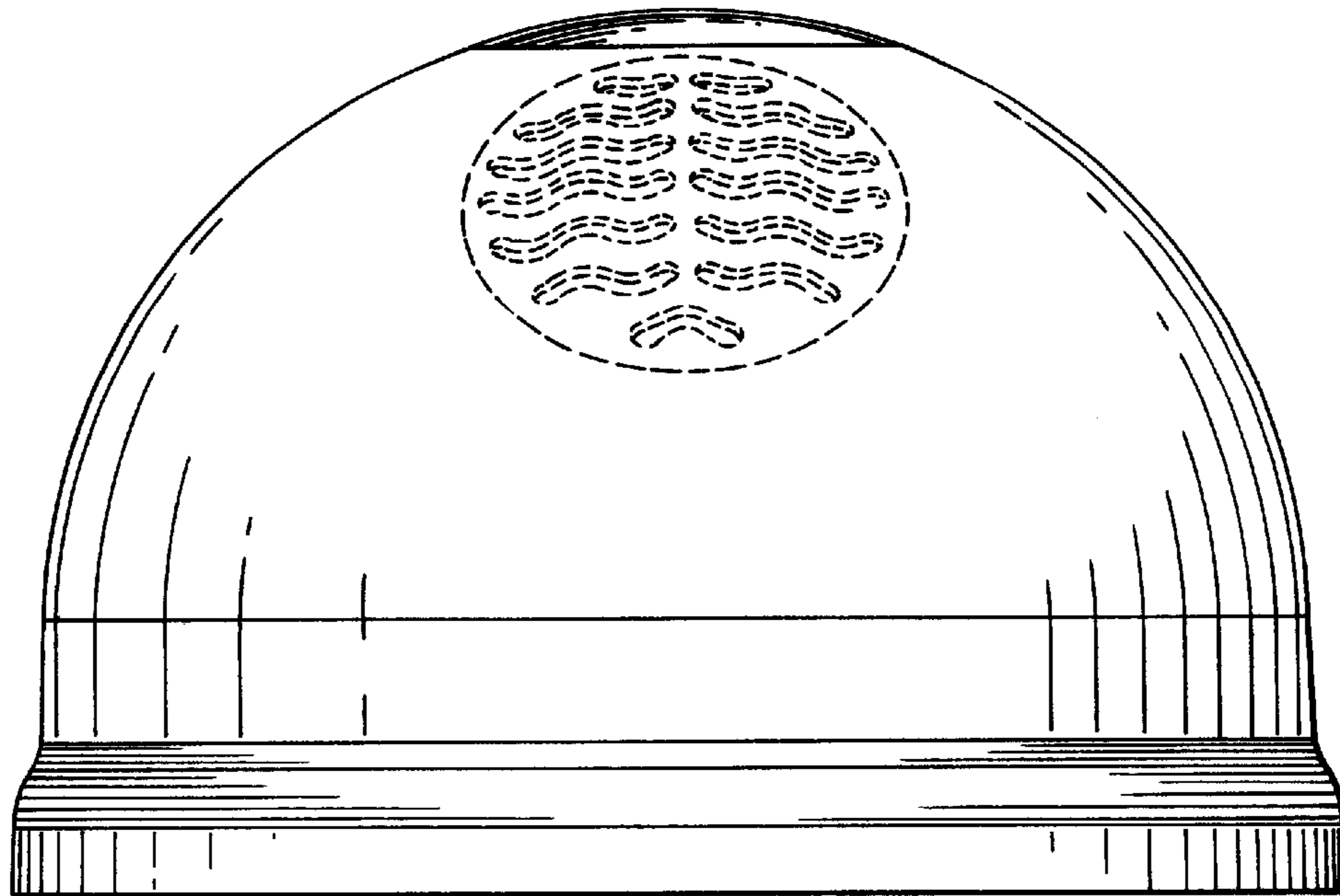

FIG. 7

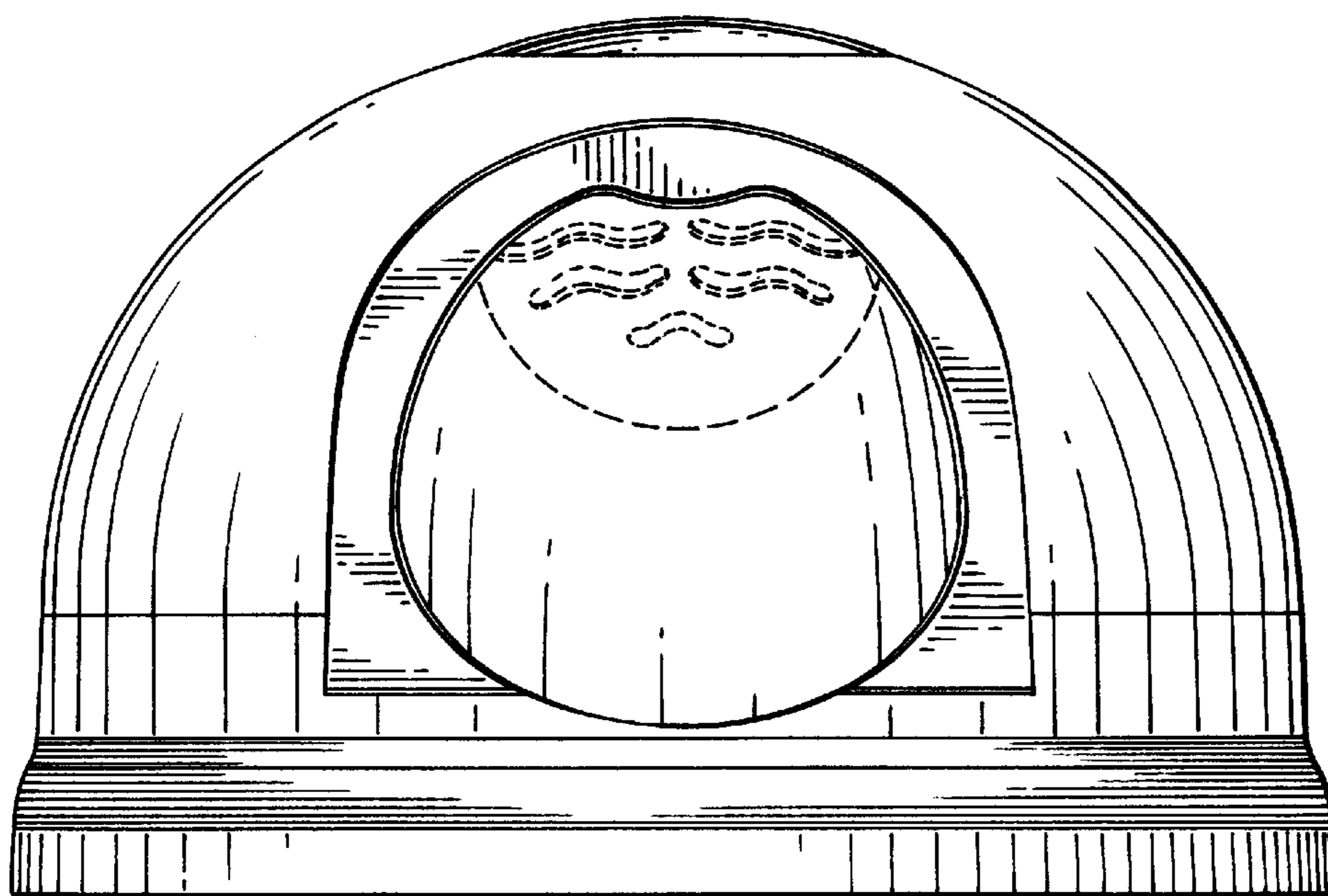

FIG. 8

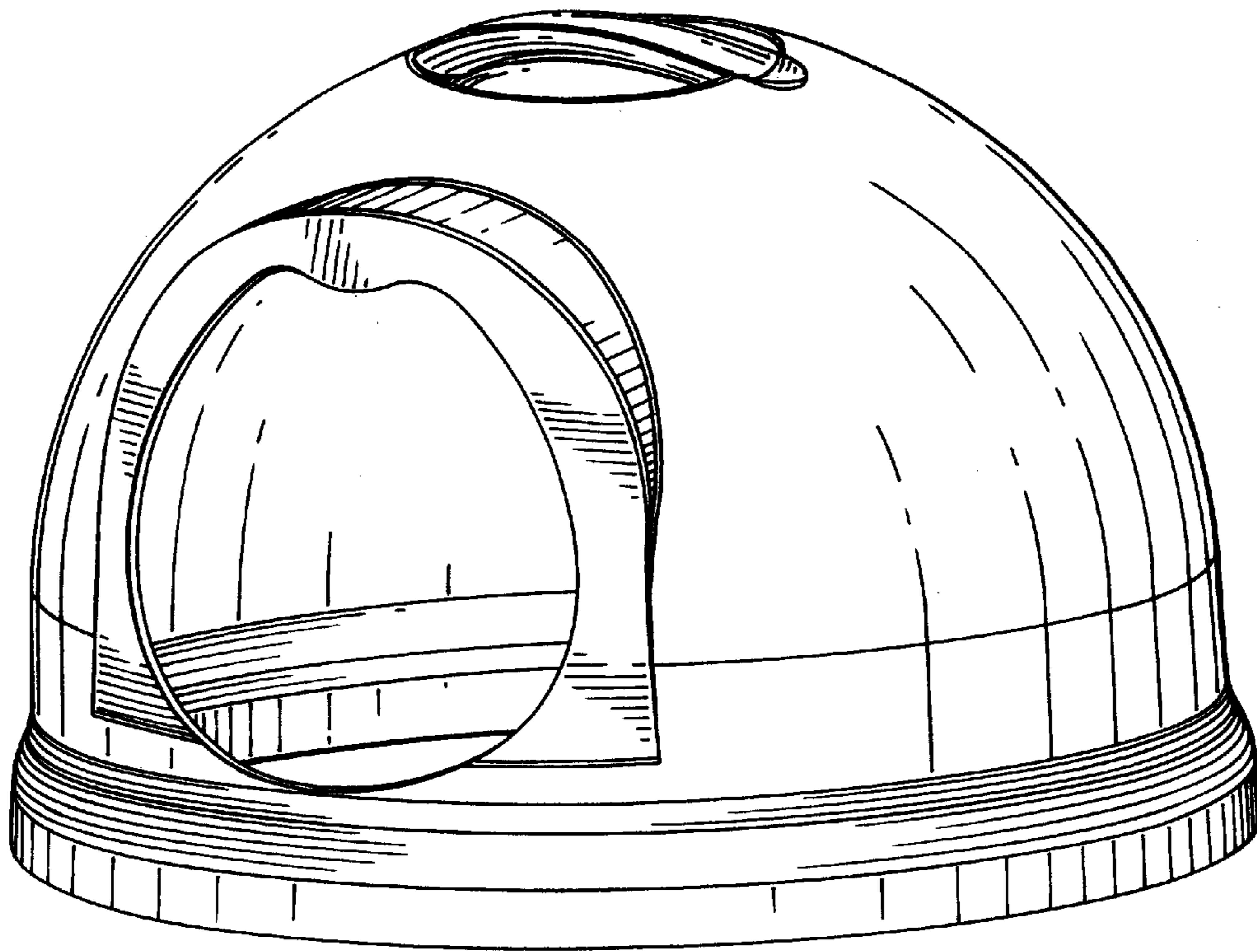

FIG. 9

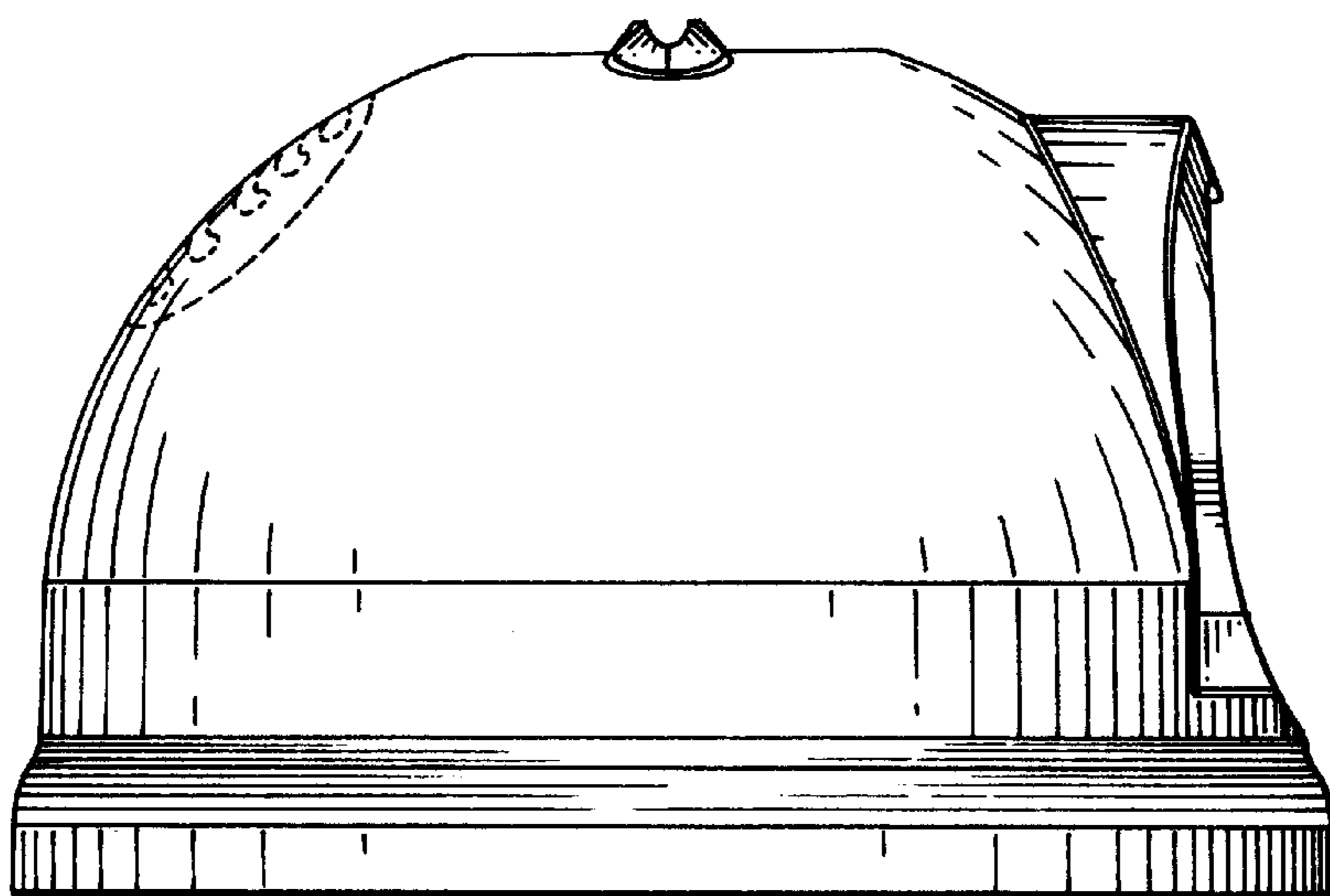

FIG. 10

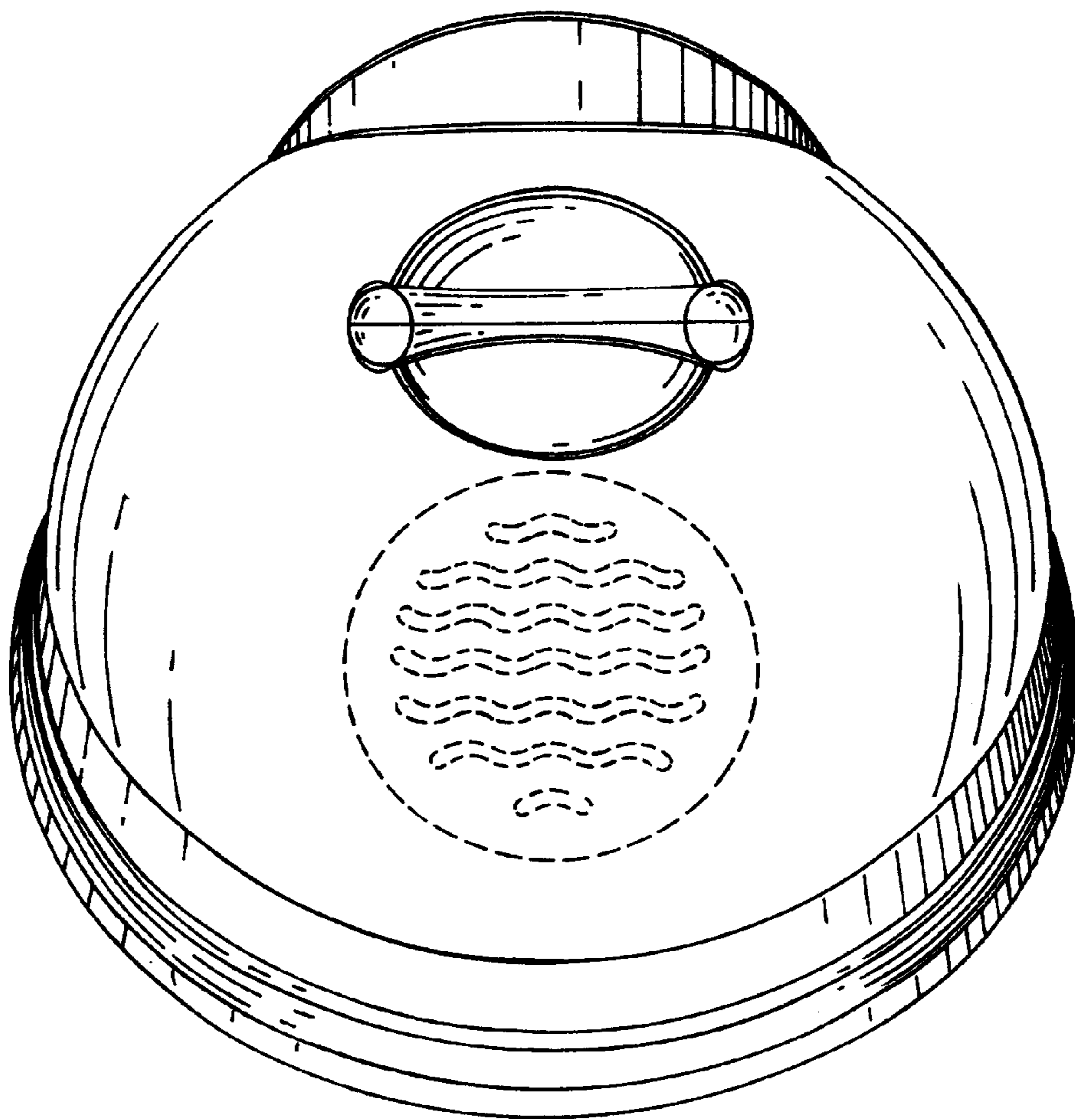

FIG. 11

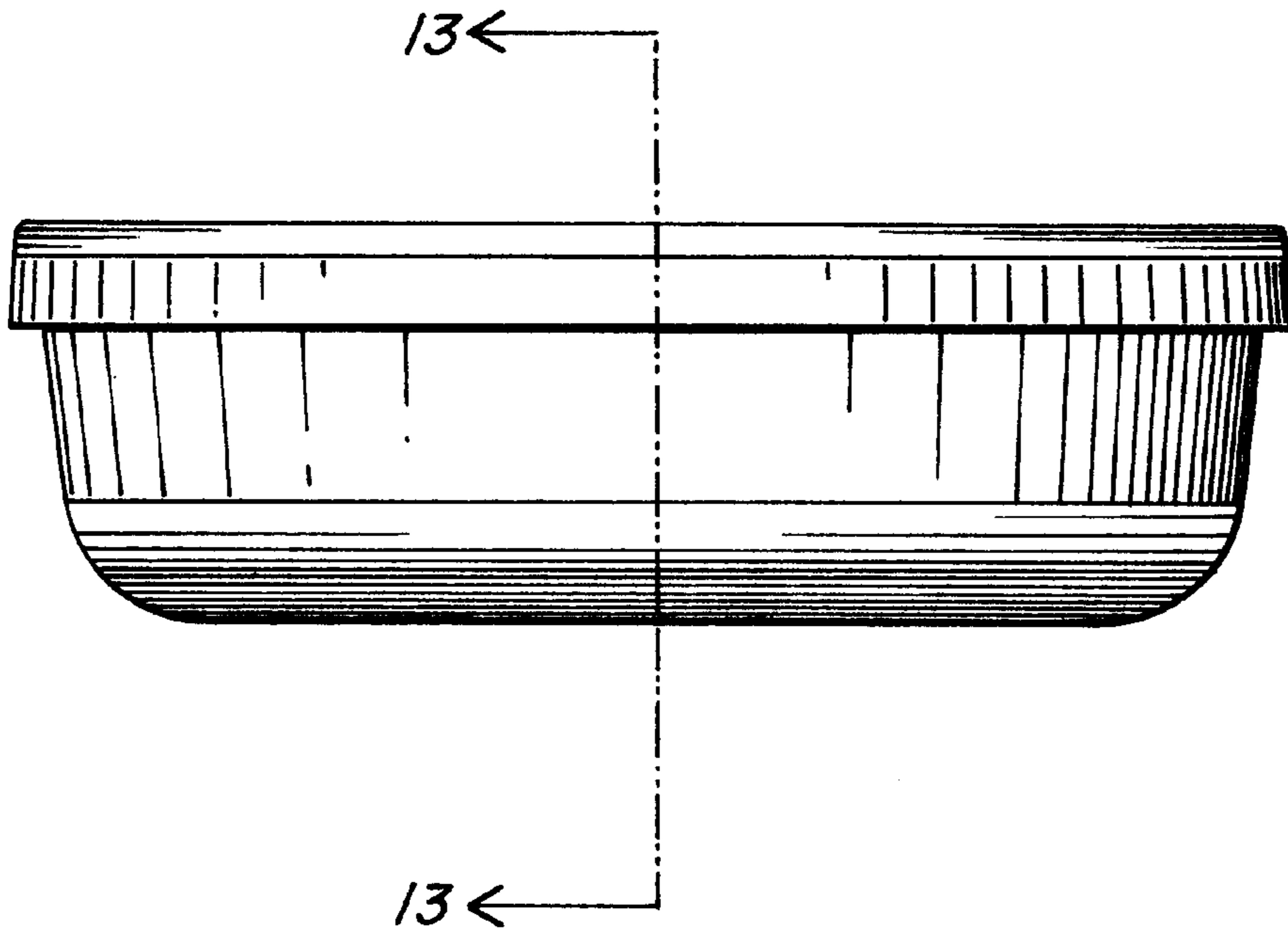

FIG. 12

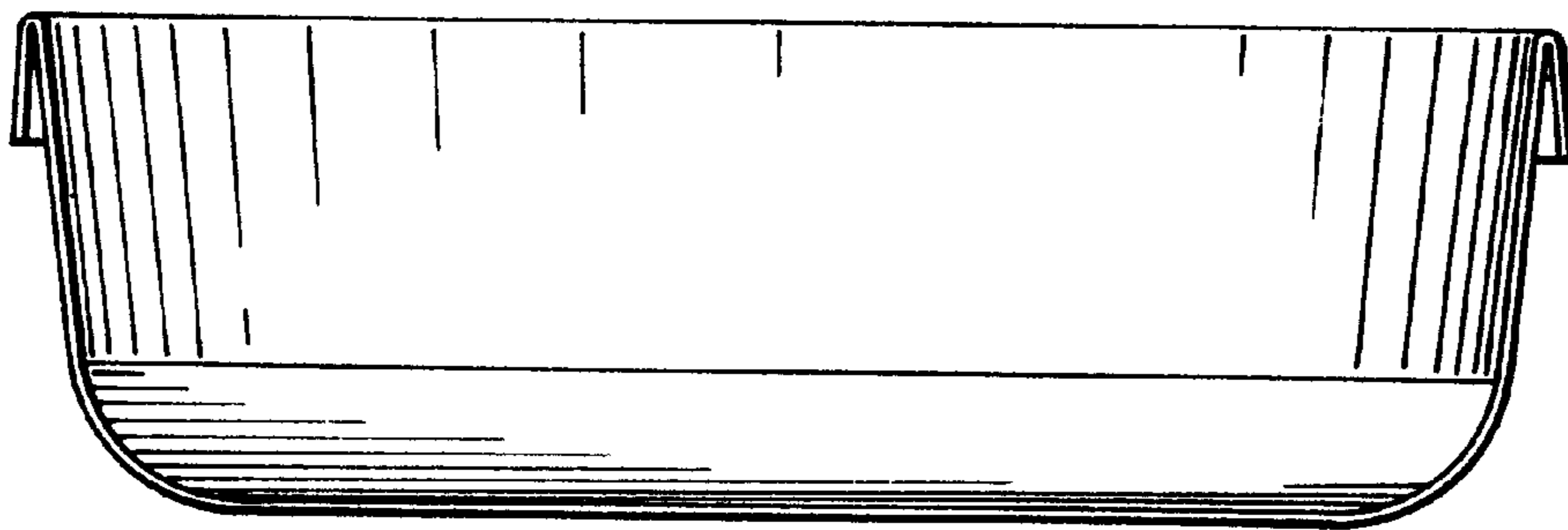

FIG. 13

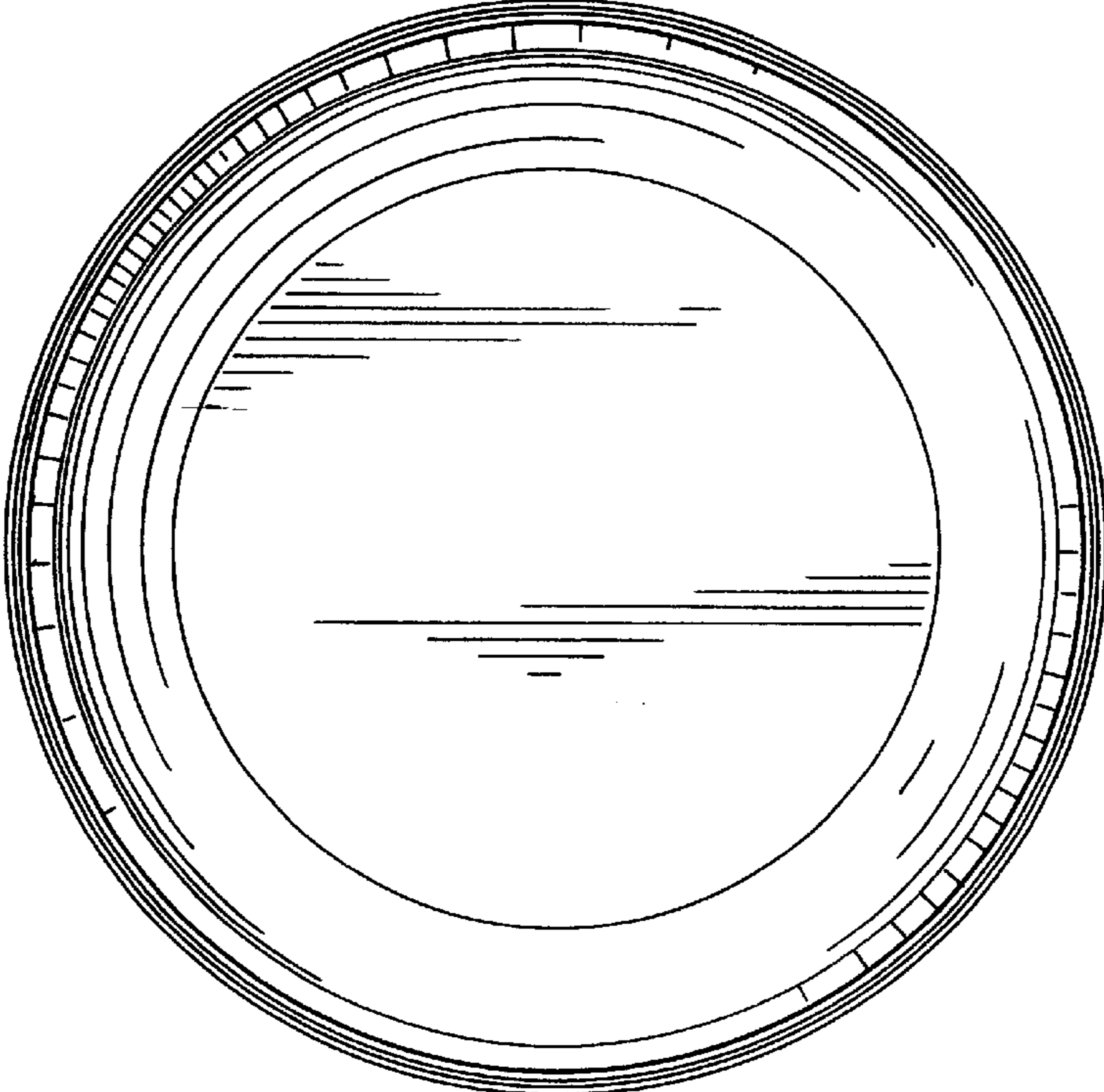

FIG. 14

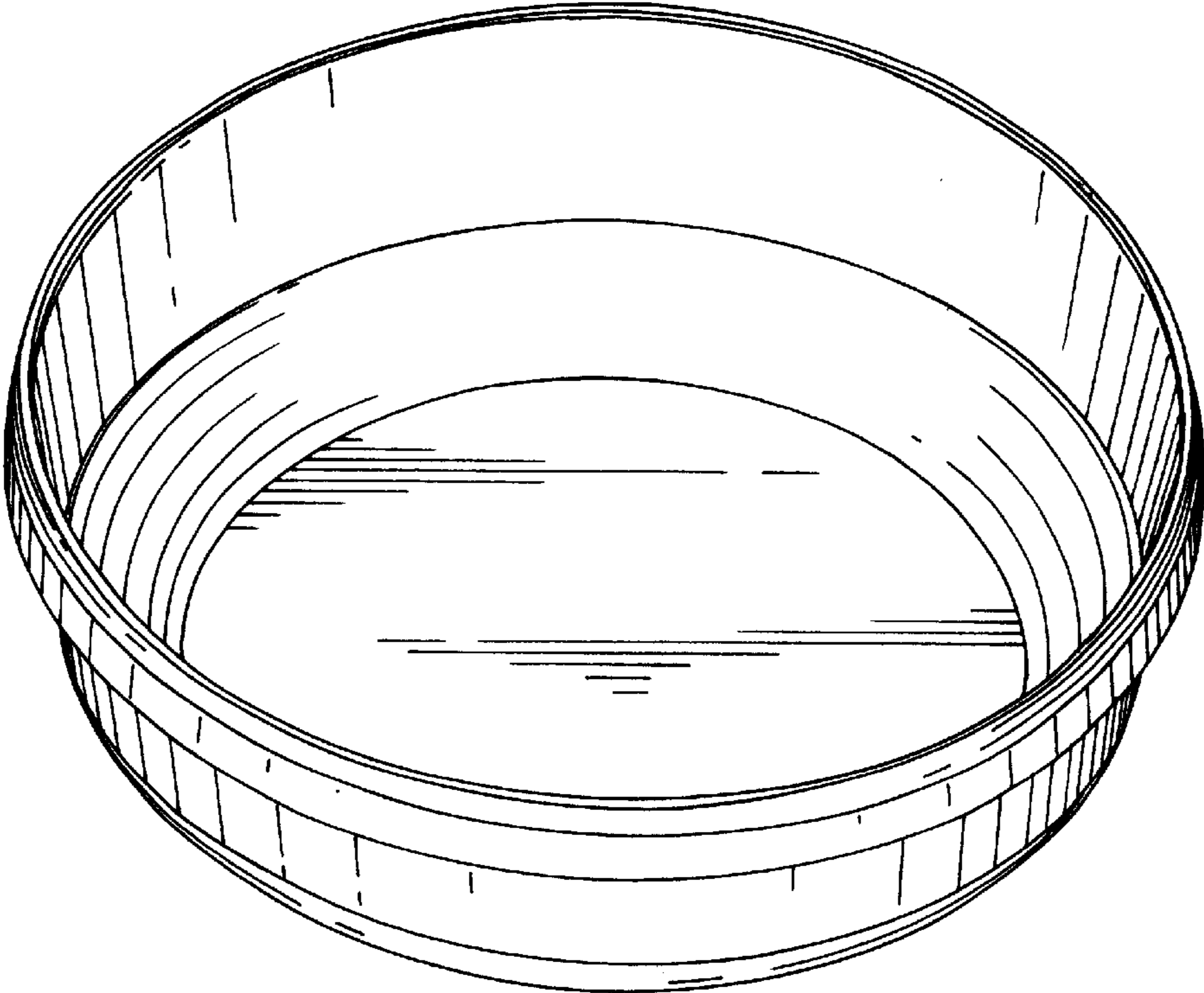

FIG. 15