



US00D496480S1

(12) **United States Design Patent** (10) **Patent No.:** **US D496,480 S**  
**Slattery et al.** (45) **Date of Patent:** **\*\* Sep. 21, 2004**

(54) **FLASHLIGHT AND RECHARGING UNIT**

*Primary Examiner*—Marcus A. Jackson  
(74) *Attorney, Agent, or Firm*—Morriss O’Bryant  
Compagni, P.C.

(76) Inventors: **Phillip Slattery**, 4 Carol Court,  
Warrandyte, Victoria (AU), 3113;  
**Martin Lee**, 3750 #2 Pony Dr., Wilson,  
WY (US) 83014; **Ray Paslawski**, 10  
Topping La., St. Louis, MO (US)  
63131; **Greg Paslawski**, 10 Topping  
La., St. Louis, MO (US) 63131

(57) **CLAIM**

The ornamental design for the flashlight and recharging unit,  
as shown and described.

(\*\*) **Term:** **14 Years**

**DESCRIPTION**

(21) **Appl. No.:** **29/188,870**

FIG. 1 is a perspective view of the invention showing the  
flashlight docked in the recharging unit;

(22) **Filed:** **Aug. 26, 2003**

FIG. 2 is a perspective view of the invention showing the  
flashlight undocked from the recharging unit;

(51) **LOC (7) Cl.** ..... **26-02**

(52) **U.S. Cl.** ..... **D26/38**

FIG. 3 is a first side elevation view of the invention;

(58) **Field of Search** ..... D26/37-50; 362/157,  
362/158, 171-173, 183-208

FIG. 4 is a second side elevation view of the invention  
shown in FIG. 3 turned 180 degrees;

(56) **References Cited**

**U.S. PATENT DOCUMENTS**

5,510,691 A	4/1996	Palatov	
D385,984 S	* 11/1997	Wan	..... D26/38
D394,122 S	* 5/1998	Concari et al.	..... D26/38
5,844,472 A	12/1998	Lee	
5,847,545 A	12/1998	Chen et al.	
5,883,494 A	3/1999	Kobayashi et al.	
D414,284 S	* 9/1999	Zelina et al.	..... D26/38

FIG. 5 is a third side elevation view of the invention shown  
in FIG. 4 turned 90 degrees to the left;

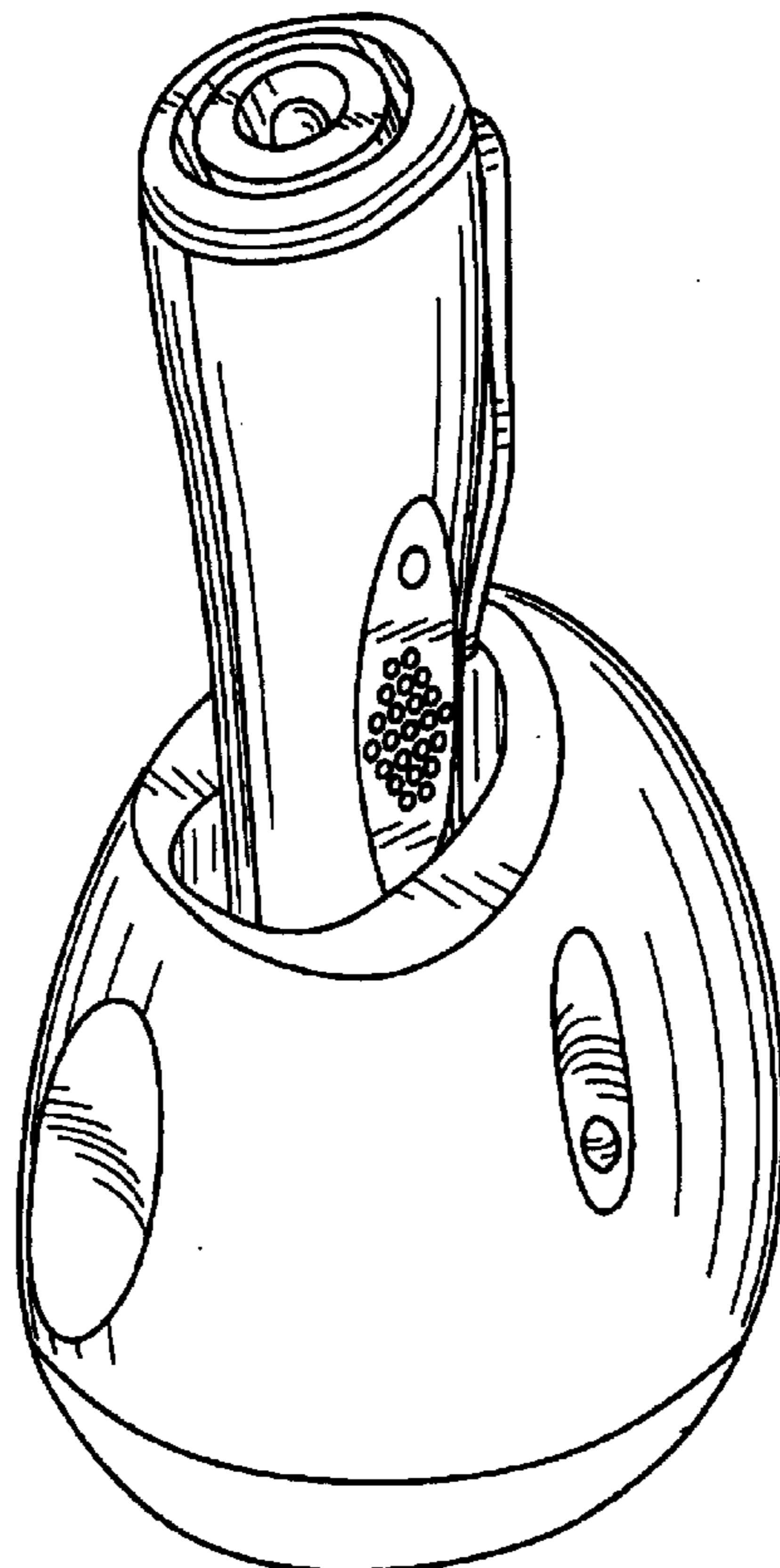
FIG. 6 is a fourth side elevation view of the invention shown  
in FIG. 5 turned 180 degrees;

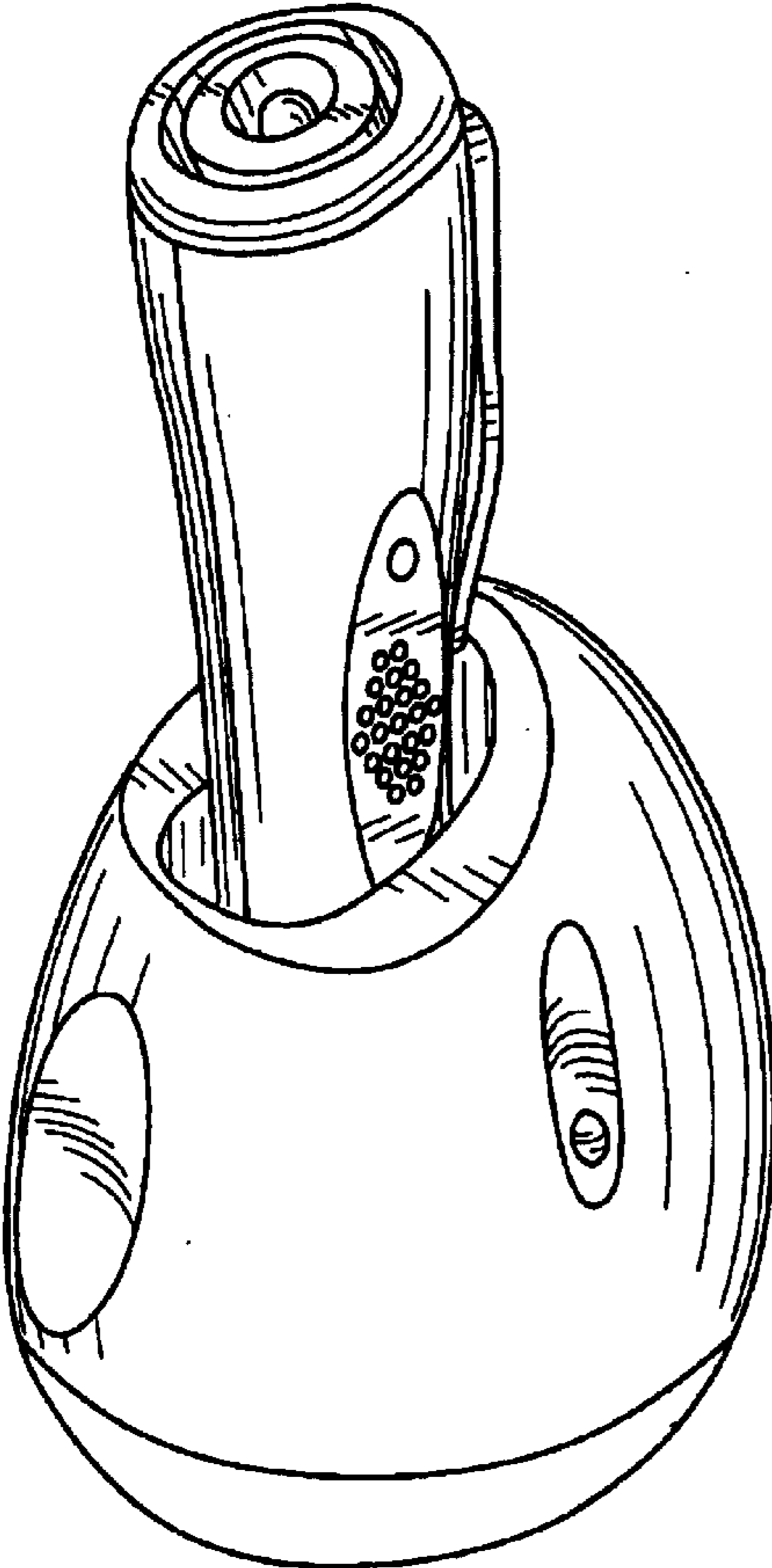
FIG. 7 is a top plan view of the invention with the flashlight  
shown to the side of the recharging unit to reveal the  
ornamental configuration of the docking port; and,

FIG. 8 is a bottom plan view of the invention.

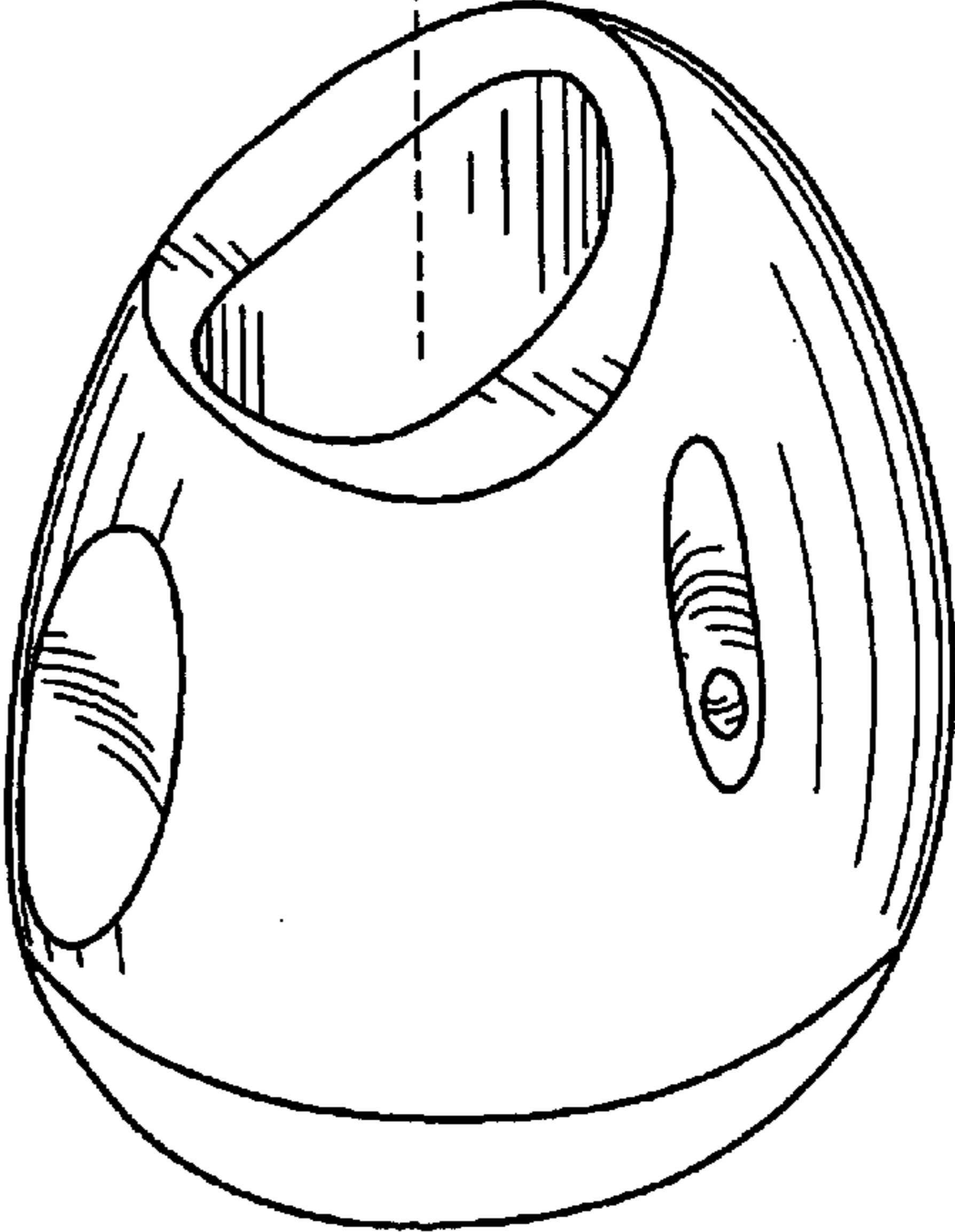
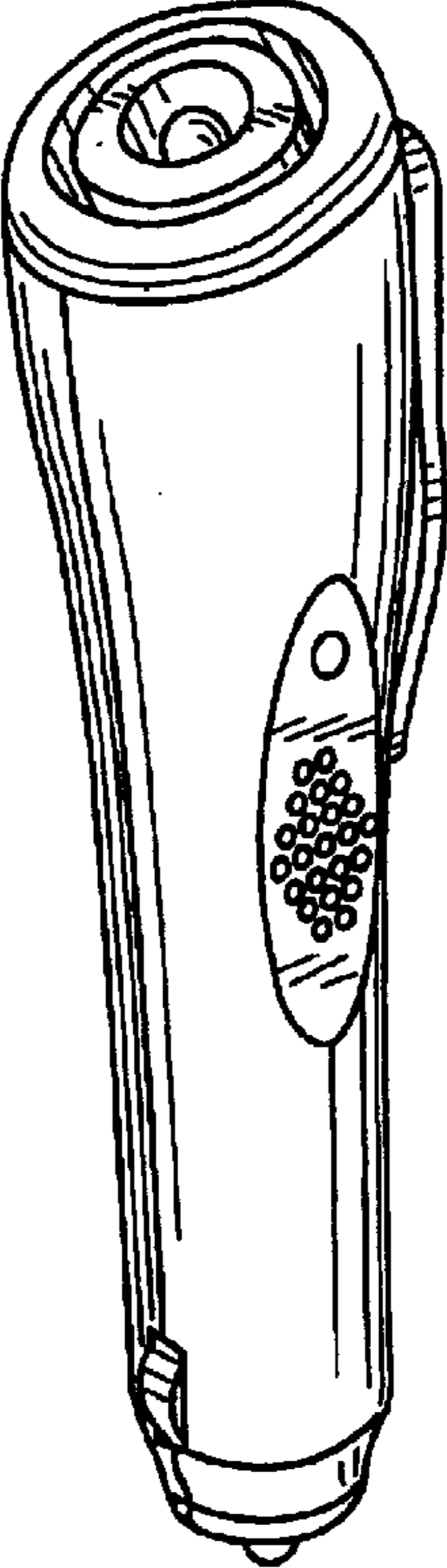
\* cited by examiner

**1 Claim, 6 Drawing Sheets**

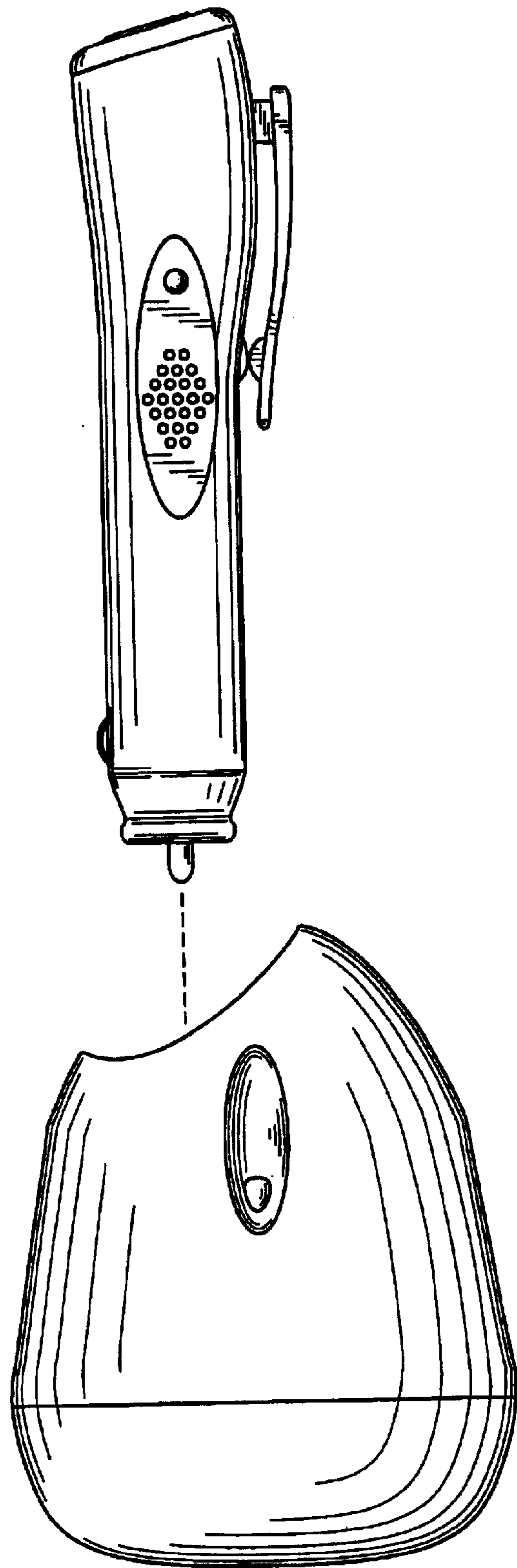




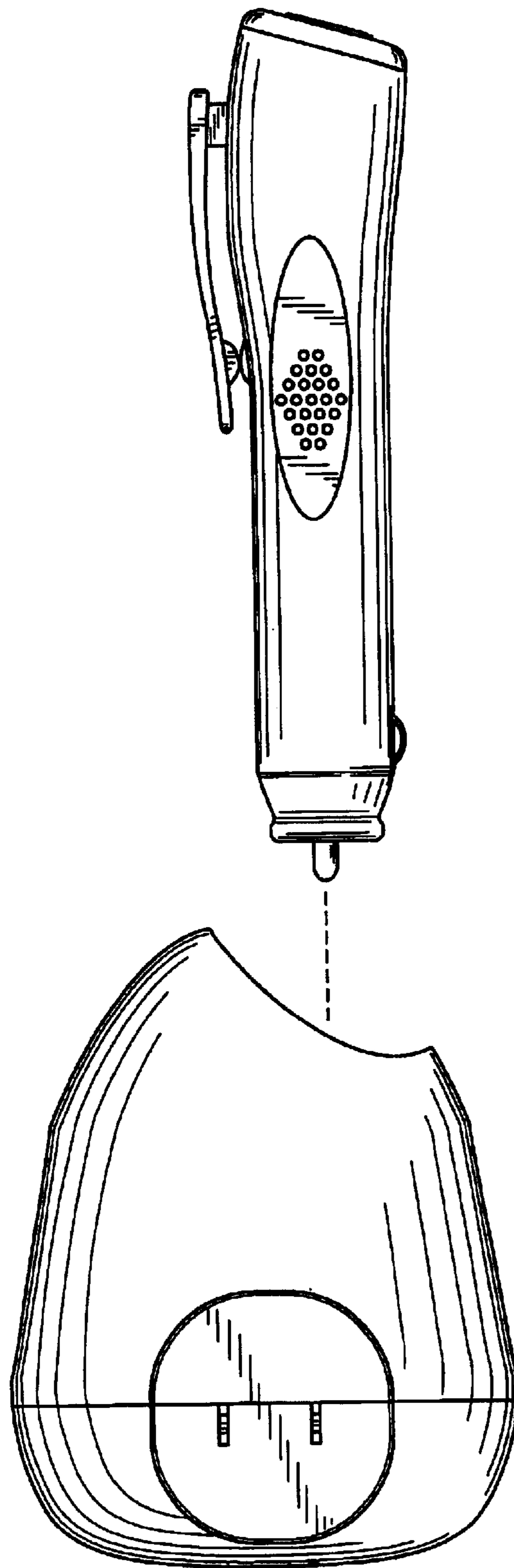
**FIG. 1**



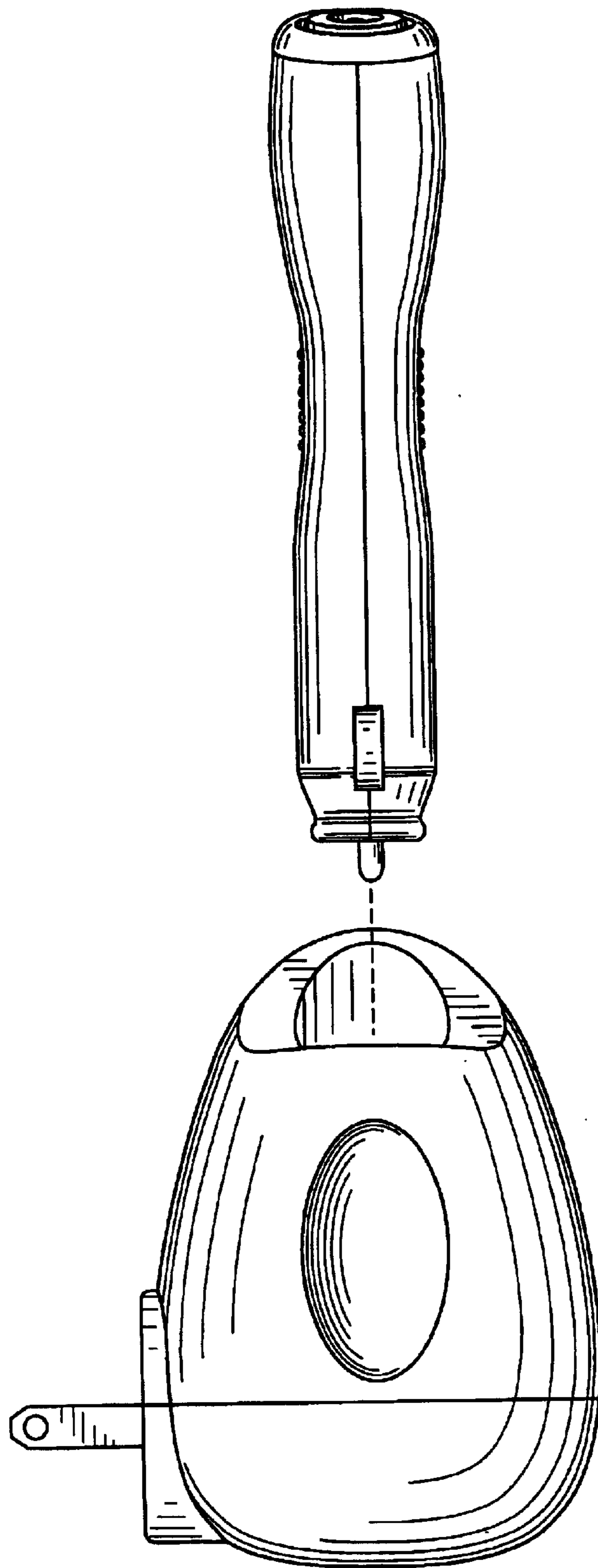
**FIG. 2**



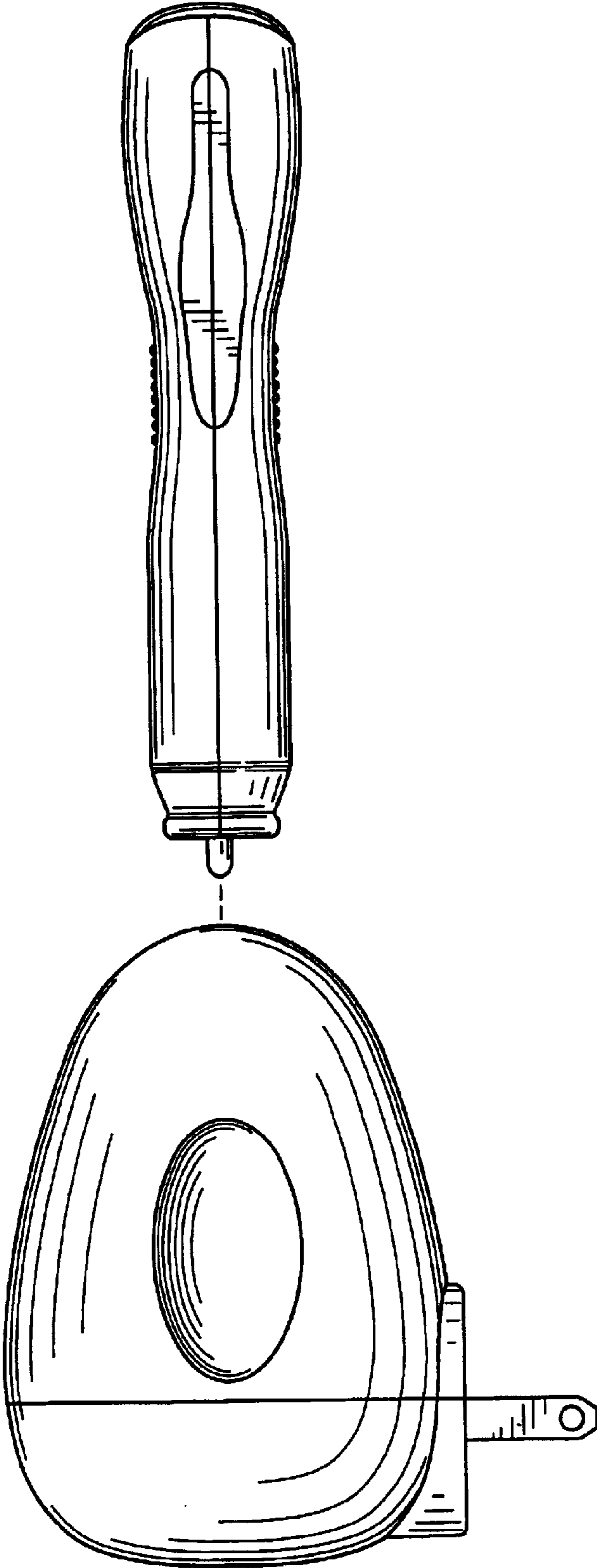
**FIG. 3**



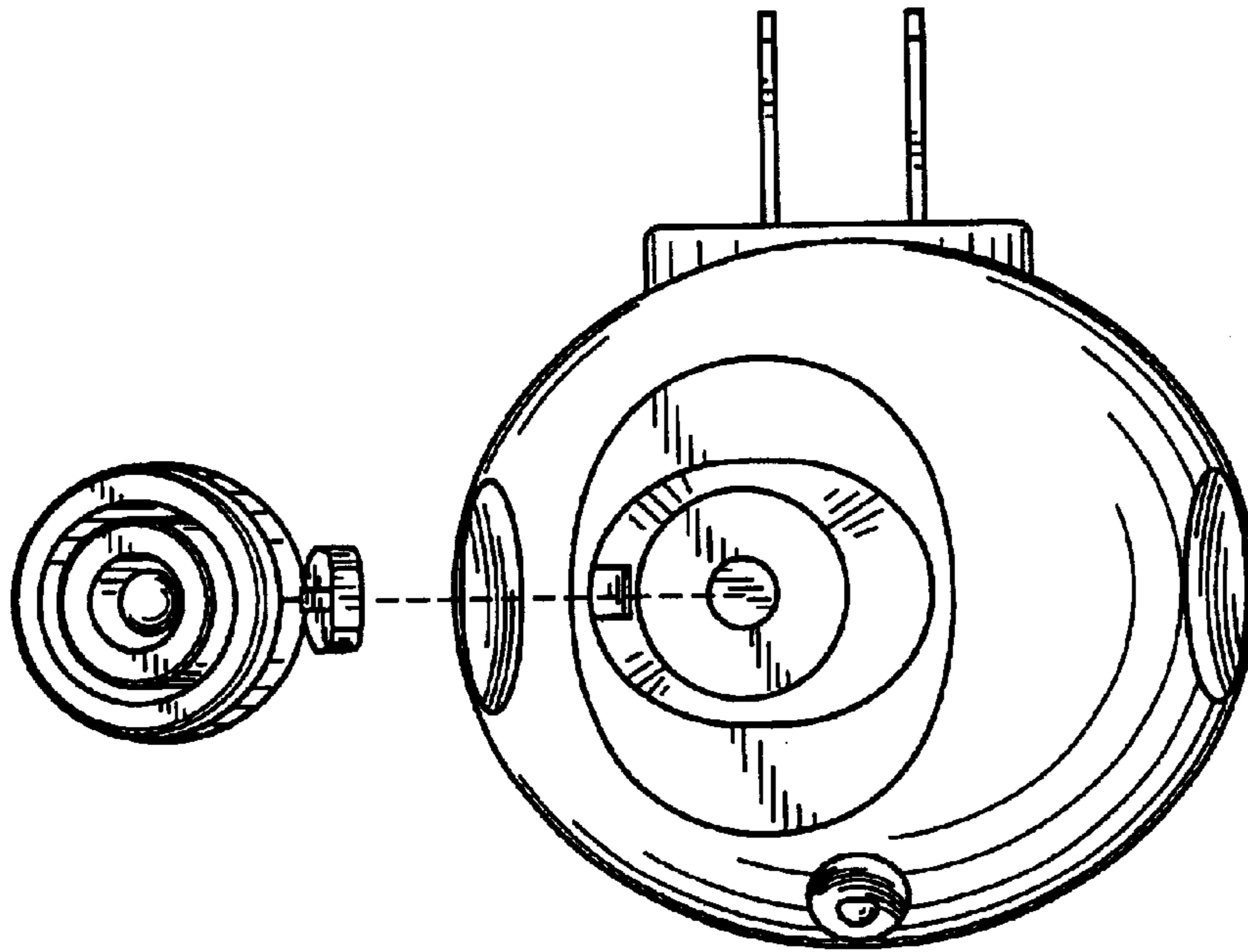
**FIG. 4**



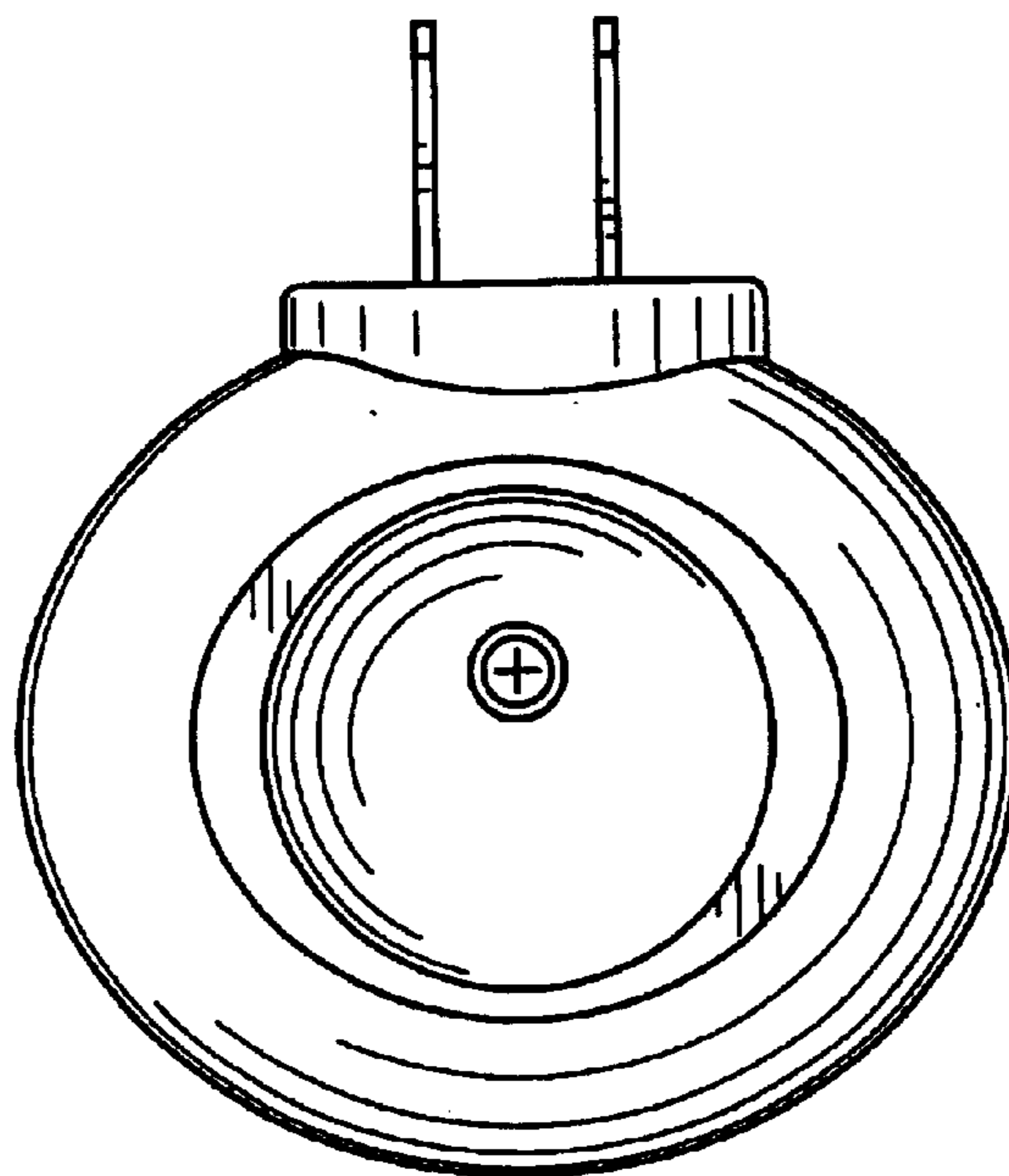
**FIG. 5**



**FIG. 6**



**FIG. 7**



**FIG. 8**