

US00D496433S1

(12) **United States Design Patent**
Fritz

(10) **Patent No.:** **US D496,433 S**

(45) **Date of Patent:** **** Sep. 21, 2004**

(54) **HANDLE**

(75) **Inventor:** **Seth A. Fritz**, Kendallville, IN (US)

(73) **Assignee:** **Masco Corporation of Indiana**,
Indianapolis, IN (US)

(**) **Term:** **14 Years**

(21) **Appl. No.:** **29/191,170**

(22) **Filed:** **Oct. 2, 2003**

(51) **LOC (7) Cl.** **23-01**

(52) **U.S. Cl.** **D23/252**

(58) **Field of Search** D23/238-243,
D23/245, 250-257; D8/300-322, 350-353,
DIG. 3; 16/110.1; 4/675-678; 137/801

(56) **References Cited**

U.S. PATENT DOCUMENTS

- D404,470 S * 1/1999 Pitsch et al. D23/252
- D460,808 S * 7/2002 Otero et al. D23/252
- D468,407 S * 1/2003 Otero et al. D23/252

D482,759 S * 11/2003 Otero D23/252

* cited by examiner

Primary Examiner—Louis S. Zarfes

Assistant Examiner—Gregory Andoll

(74) *Attorney, Agent, or Firm*—Kwadjo Adusei-Poku;
Lloyd D. Doigan

(57) **CLAIM**

The ornamental design for a handle, as shown and described.

DESCRIPTION

FIG. 1 is a front perspective view of a handle showing my new design;
FIG. 2 is a rear elevational view thereof;
FIG. 3 is a left side elevational view thereof;
FIG. 4 is a front elevational view thereof;
FIG. 5 is a top plan view thereof;
FIG. 6 is a right side elevational view thereof;
FIG. 7 is a rear elevational view thereof; and,
FIG. 8 is a bottom plan view thereof.

1 Claim, 4 Drawing Sheets

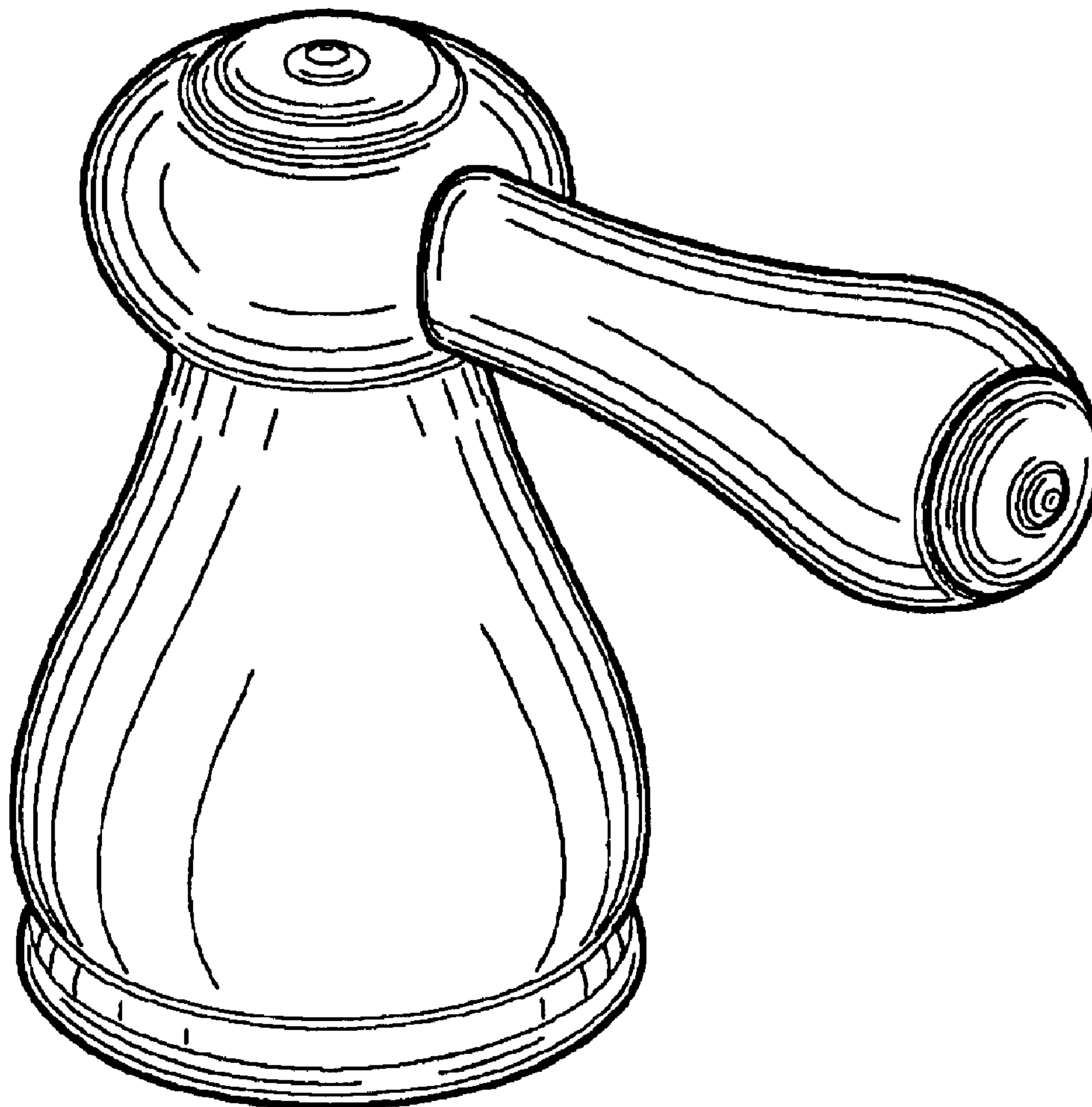

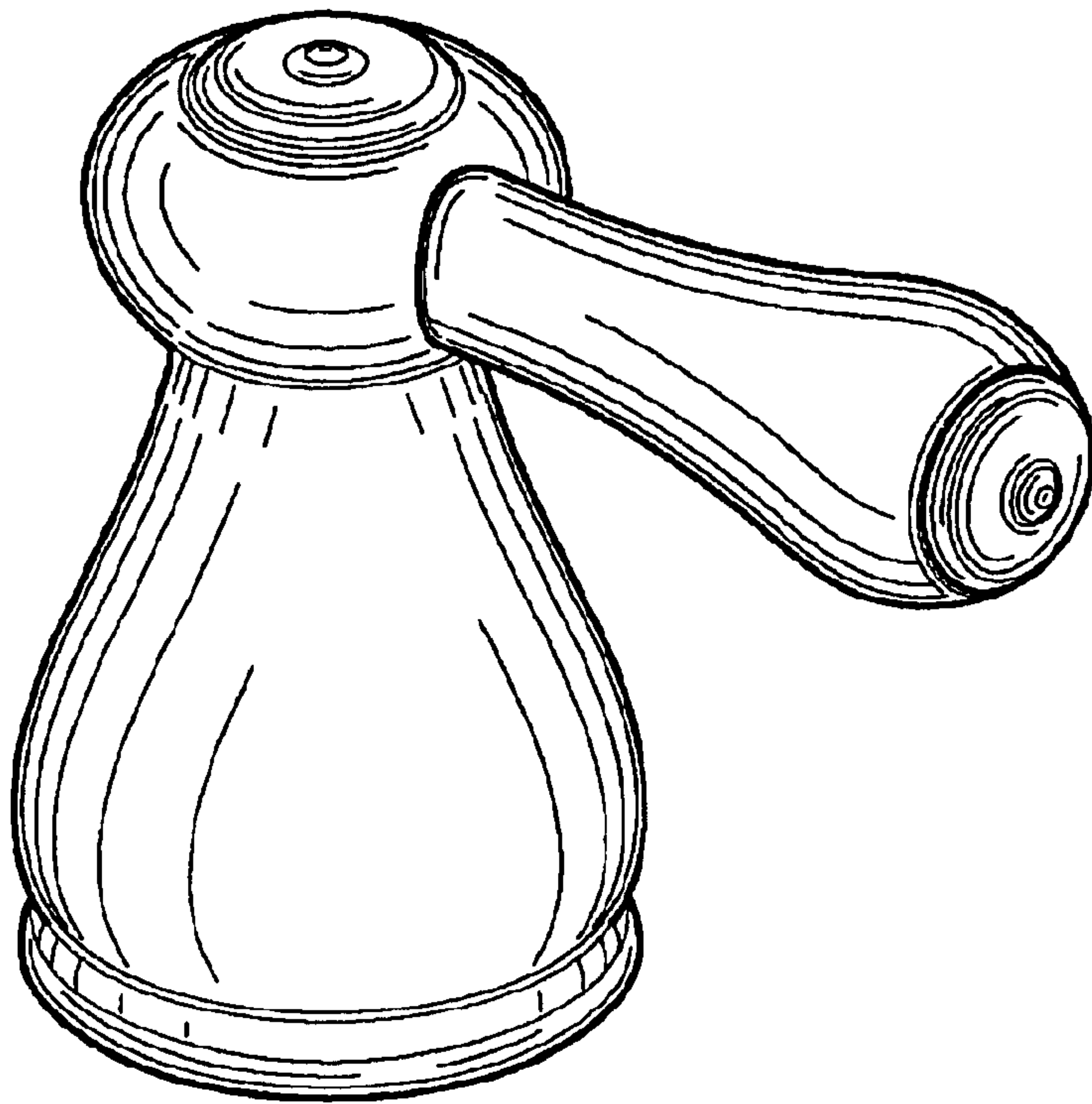

FIG - 1

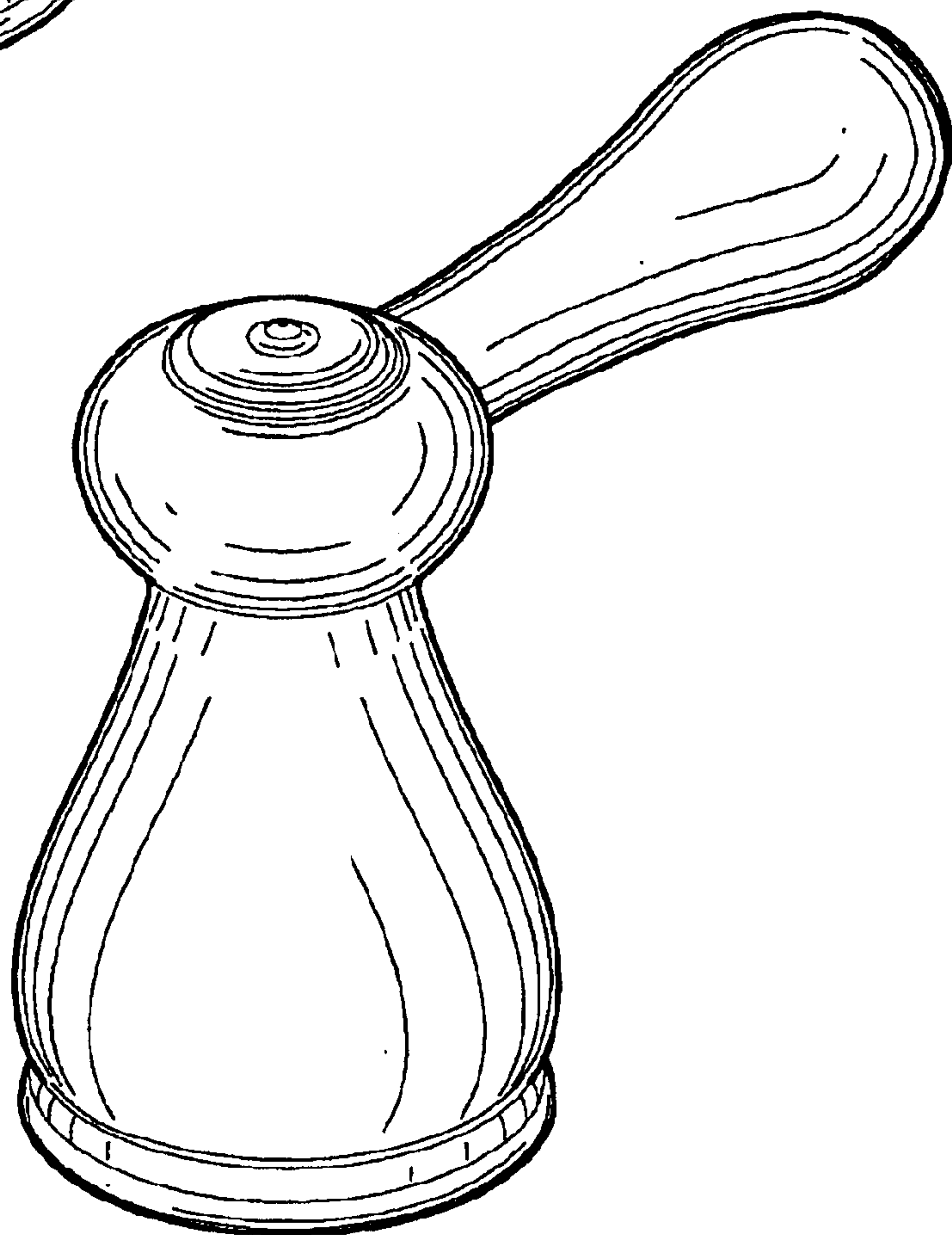

FIG - 2

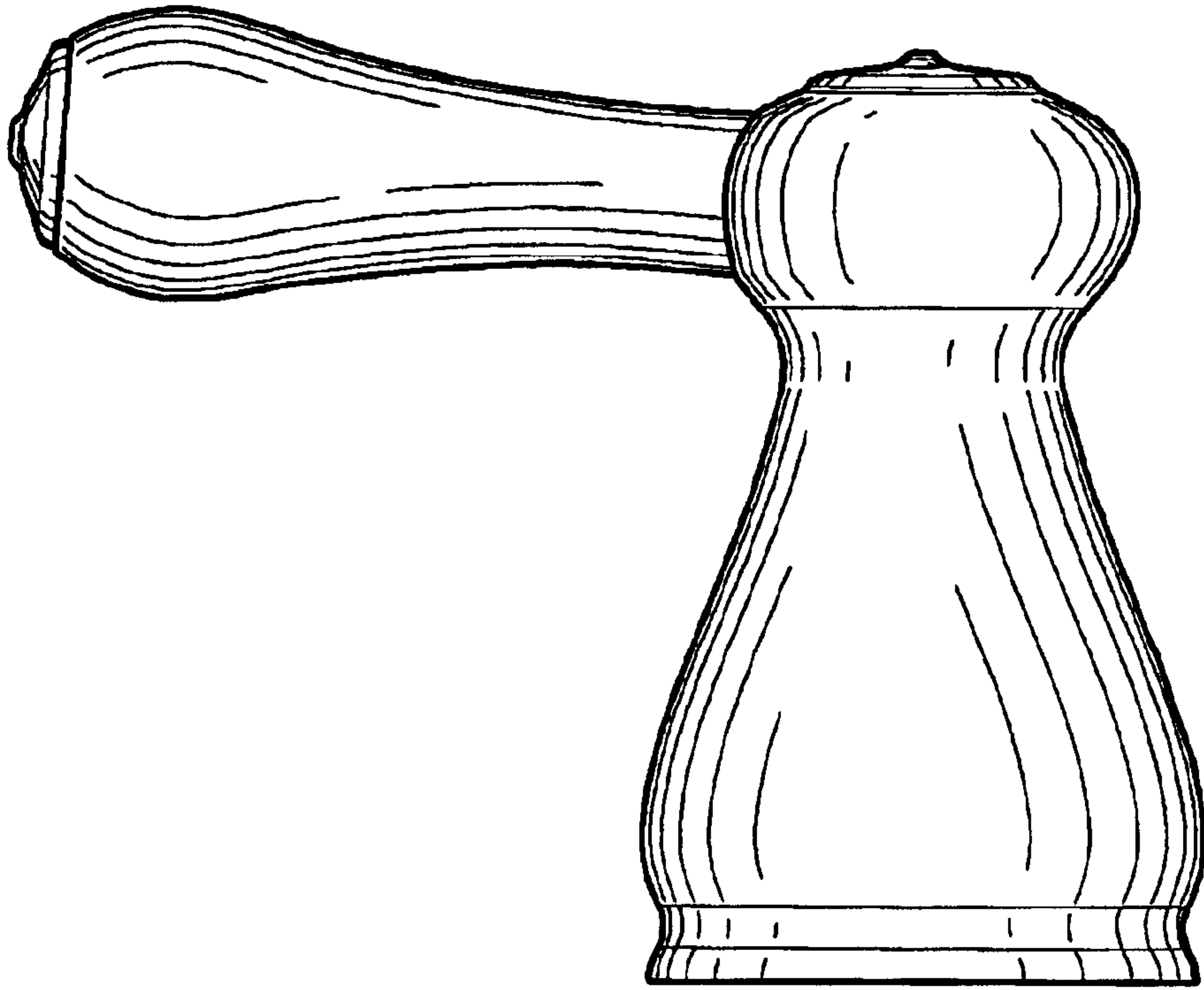

FIG - 3

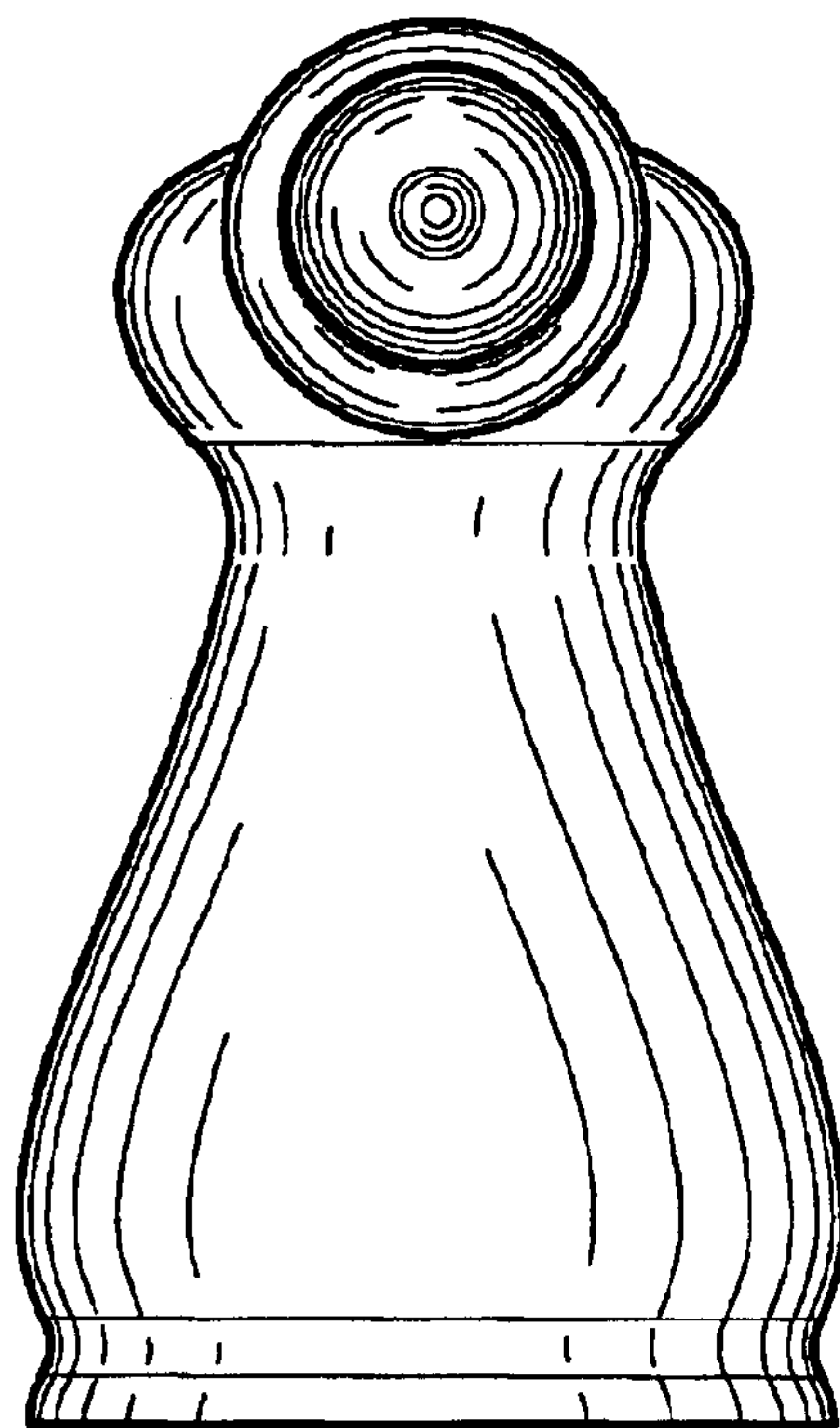

FIG - 4

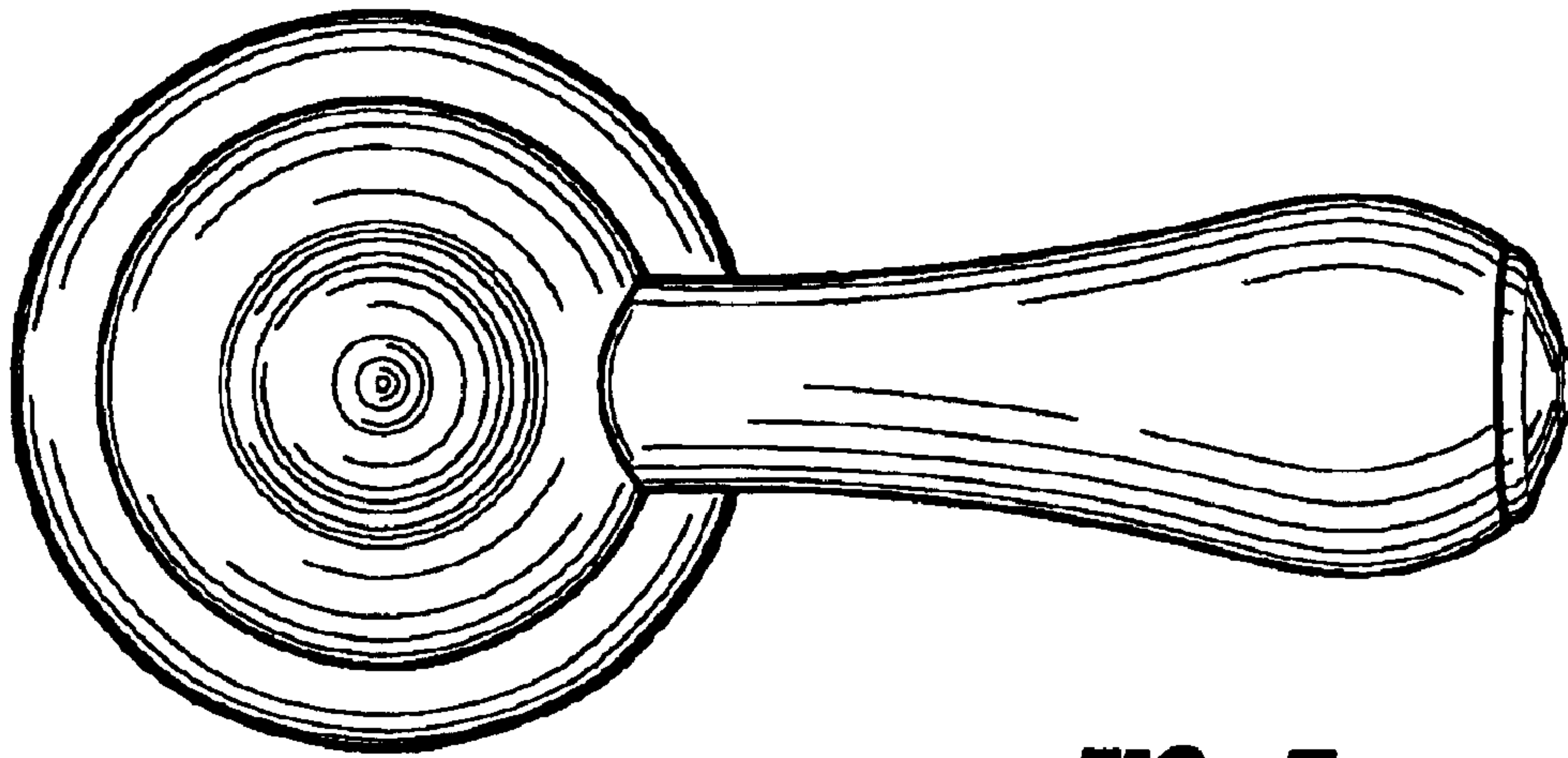

FIG - 5

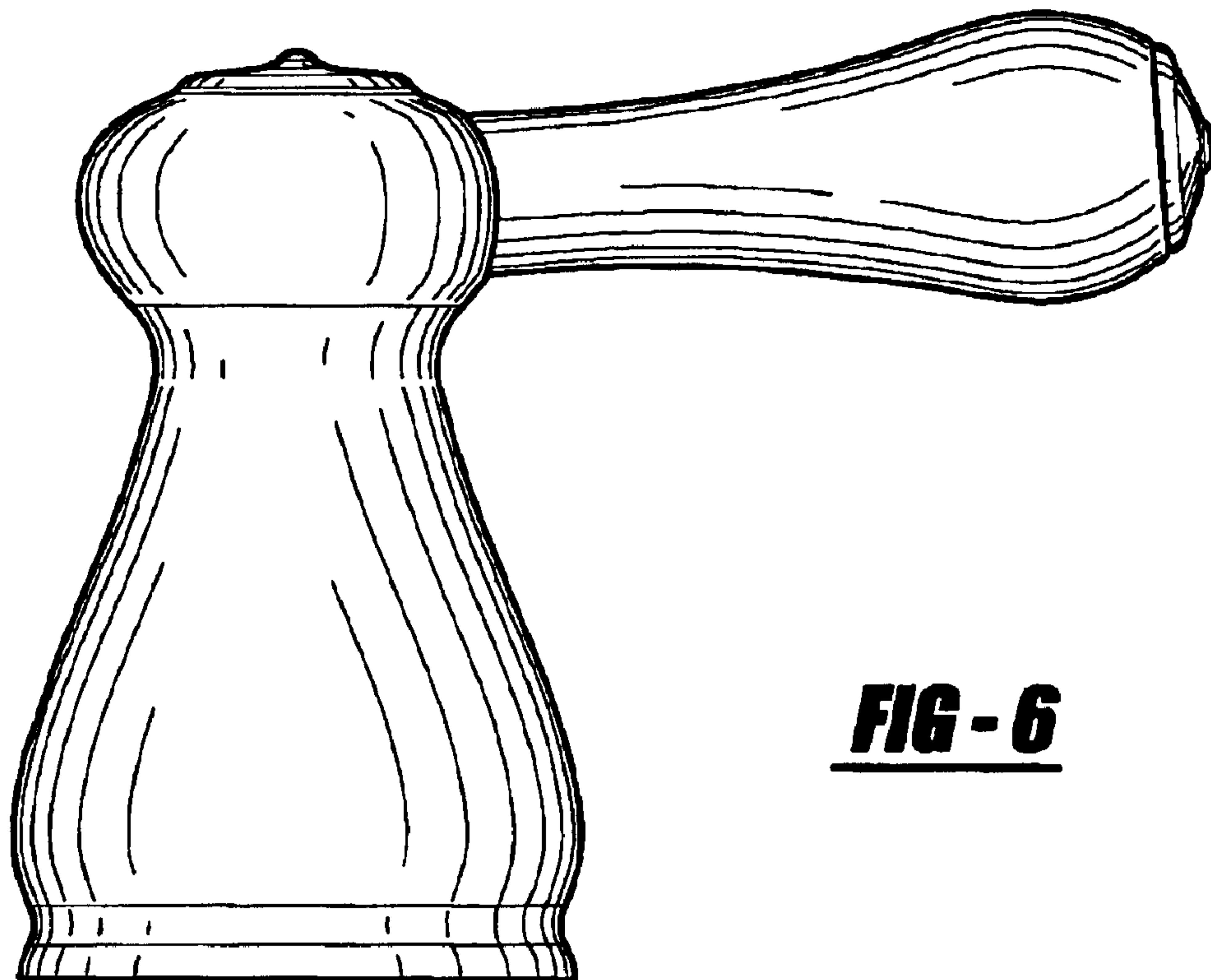

FIG - 6

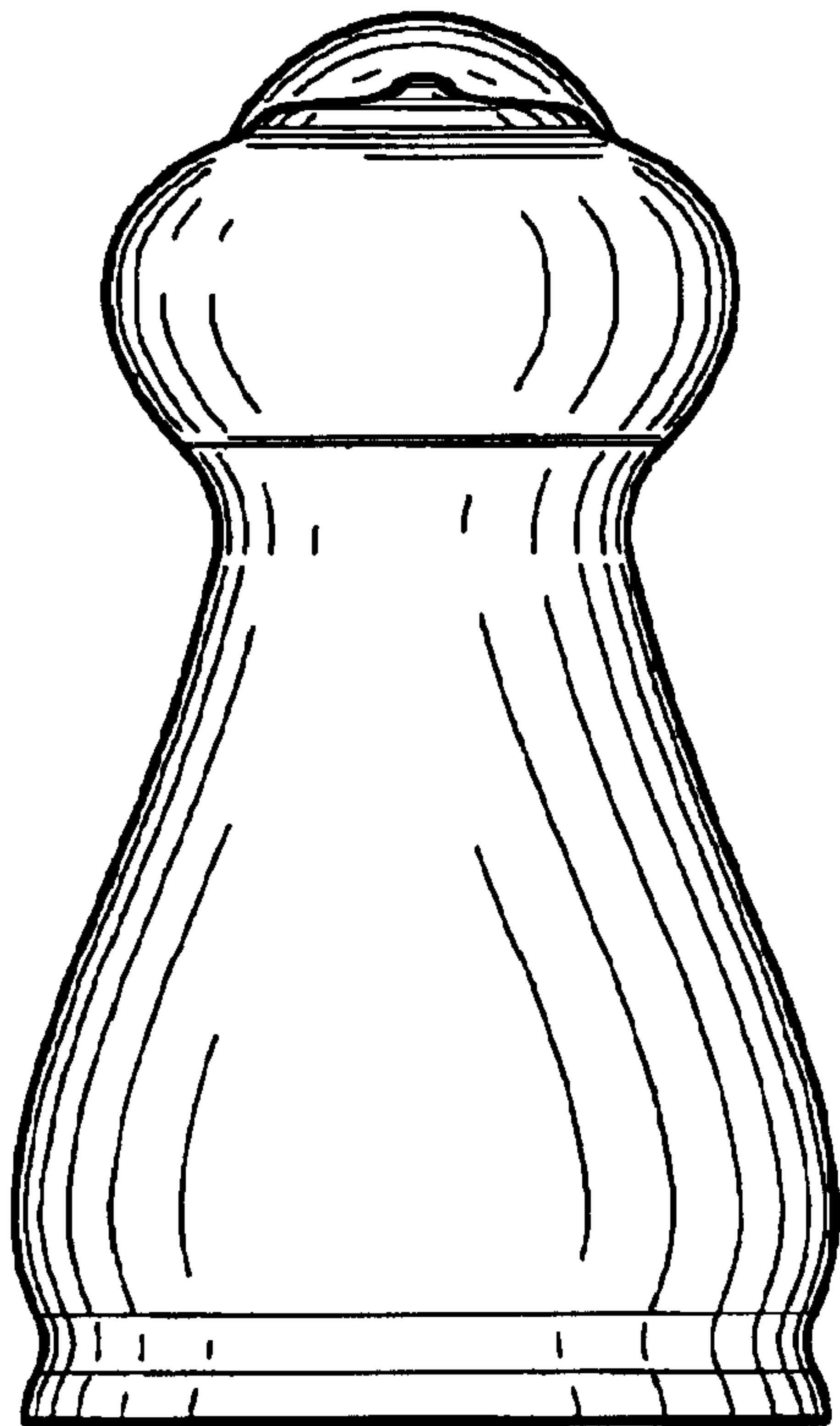

FIG - 7

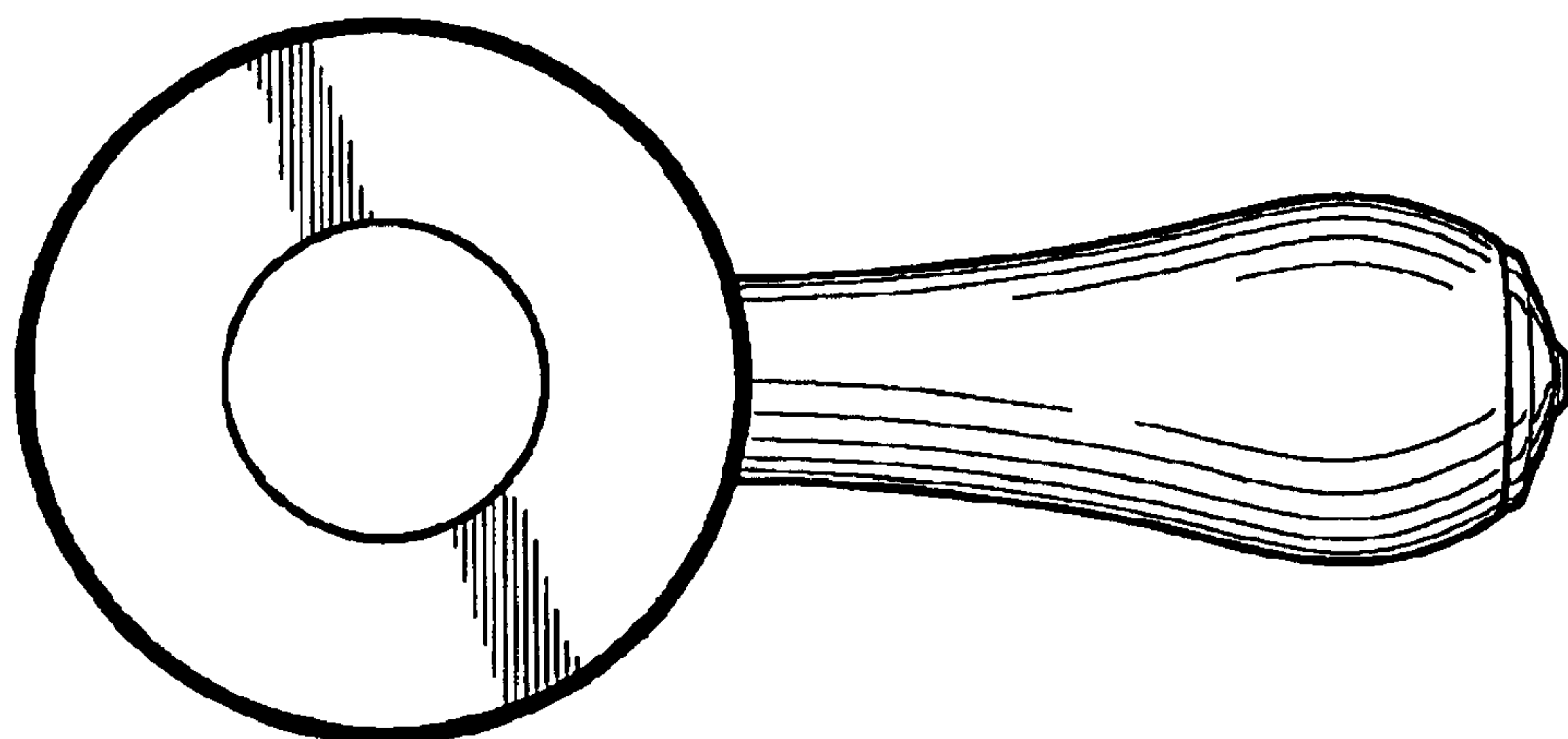

FIG - 8