



US00D496420S1

(12) **United States Design Patent** (10) **Patent No.:** **US D496,420 S**
Nishitani et al. (45) **Date of Patent:** **** Sep. 21, 2004**

(54) **GOLF CLUB HEAD**

(76) Inventors: **Masafumi Nishitani**, c/o Bridgestone Sports Co., LTD., 6-22-7, Minami-oi, Shinagawa-ku, Tokyo 140-0013 (JP); **Atsuo Tateno**, c/o Bridgestone Sports Co., LTD., 6-22-7, Minami-oi, Shinagawa-ku, Tokyo 140-0013 (JP)

(**) Term: **14 Years**

(21) Appl. No.: **29/193,839**

(22) Filed: **Nov. 17, 2003**

(30) **Foreign Application Priority Data**

Jul. 29, 2003 (KR) 30-2003-0021472

(51) **LOC (7) Cl.** **21-02**

(52) **U.S. Cl.** **D21/752**

(58) **Field of Search** D21/733, 752, D21/759; 473/324-331, 343-346

(56) **References Cited**

U.S. PATENT DOCUMENTS

D357,290 S * 4/1995 Viollaz et al. D21/752
D383,818 S * 9/1997 Williams, Jr. D21/752
D433,073 S * 10/2000 Sodano D21/752
6,217,461 B1 * 4/2001 Galy 473/328

FOREIGN PATENT DOCUMENTS

JP 1138299 4/2002

* cited by examiner

Primary Examiner—Mitchell Siegel

(74) *Attorney, Agent, or Firm*—Morgan, Lewis & Bockius LLP

(57) **CLAIM**

The ornamental design for a golf club head, as shown and described.

DESCRIPTION

FIG. 1 is a front view of a first embodiment of a golf club head in accordance with our new design.

FIG. 2 is a rear view of the first embodiment of a golf club head in accordance with our new design.

FIG. 3 is a left-side view of the first embodiment of a golf club head in accordance with our new design.

FIG. 4 is a right-side view of the first embodiment a golf club head in accordance with of our new design.

FIG. 5 is a top view of the first embodiment of a golf club head in accordance with our new design.

FIG. 6 is a bottom view of the first embodiment a golf club head in accordance with our new design.

FIG. 7 is a first perspective view of the first embodiment of a golf club head in accordance with our new design.

FIG. 8 is a second perspective view of the first embodiment of a golf club head in accordance with our new design.

FIG. 9 is a cross-section view taken along line 9—9 in FIG. 1.

FIG. 10 is a cross-section view taken along line 10—10 in FIG. 3.

FIG. 11 is a front view of a second embodiment of a golf club head in accordance with our new design.

FIG. 12 is a rear view of the second embodiment of a golf club head in accordance with our new design.

FIG. 13 is a left-side view of the second embodiment of a golf club head in accordance with our new design.

FIG. 14 is a right-side view of the second embodiment a golf club head in accordance with of our new design.

FIG. 15 is a top view of the second embodiment of a golf club head in accordance with our new design.

FIG. 16 is a bottom view of the second embodiment a golf club head in accordance with of our new design.

FIG. 17 is a first perspective view of the second embodiment of a golf club head in accordance with our new design.

FIG. 18 is a second perspective view of the second embodiment of a golf club head in accordance with our new design.

FIG. 19 is a cross-section view taken along line 19—19 in FIG. 11.

FIG. 20 is a cross-section view taken along line 20—20 in FIG. 13.

FIG. 21 is a front view of a third embodiment of a golf club head in accordance with our new design.

FIG. 22 is a rear view of the third embodiment of a golf club head in accordance with our new design.

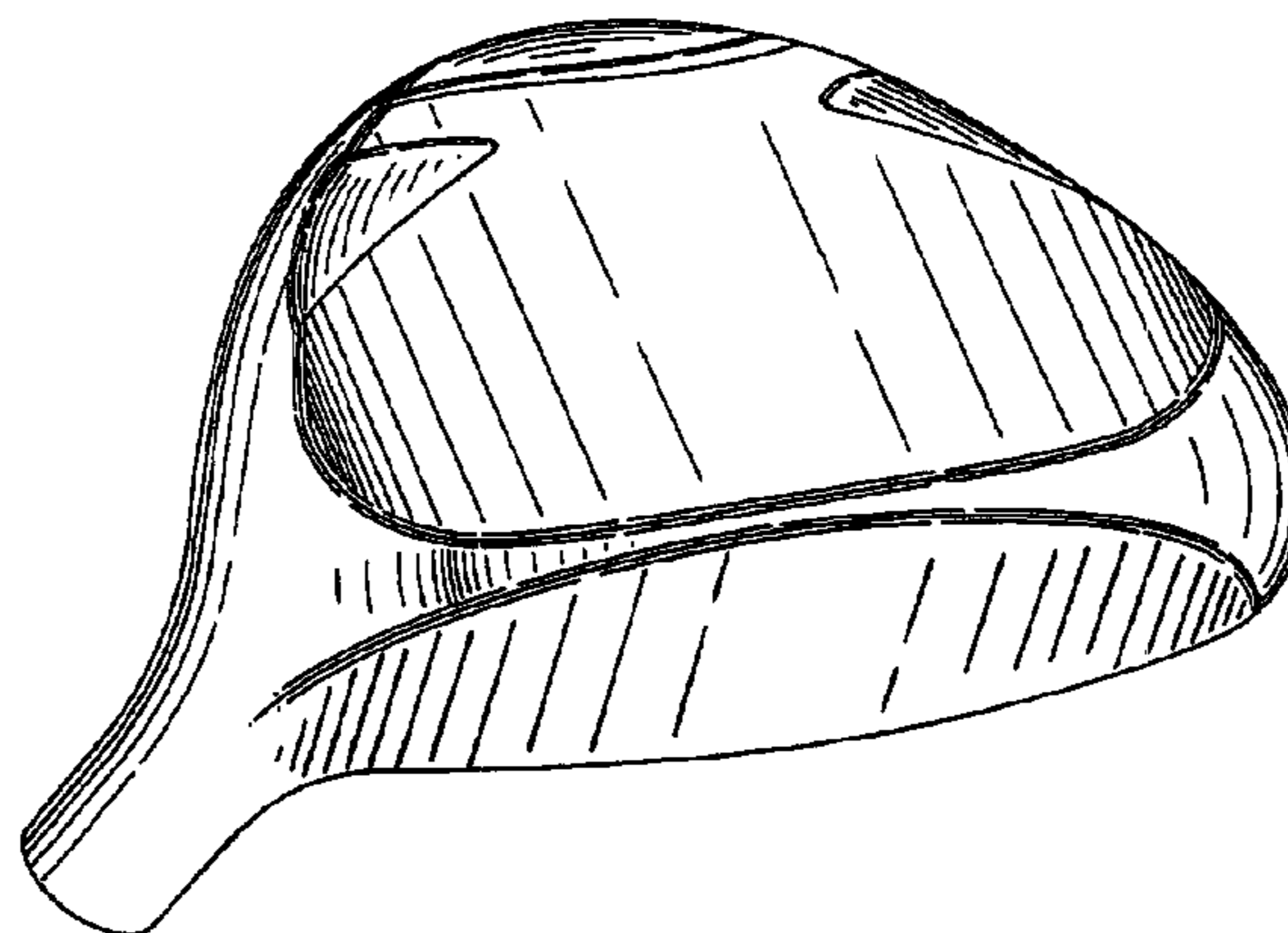

FIG. **23** is a left-side view of the third embodiment of a golf club head in accordance with our new design.

FIG. **24** is a right-side view of the third embodiment a golf club head in accordance with of our new design.

FIG. **25** is a top view of the third embodiment of a golf club head in accordance with our new design.

FIG. **26** is a bottom view of the third embodiment a golf club head in accordance with of our new design.

FIG. **27** is a first perspective view of the third embodiment of a golf club head in accordance with our new design.

FIG. **28** is a second perspective view of the third embodiment of a golf club head in accordance with our new design.

FIG. **29** is a cross-section view taken along line **29—29** in FIG. **21**; and,

FIG. **30** is a cross-section view taken along line **30—30** in FIG. **23**.

1 Claim, 15 Drawing Sheets

FIG. 1

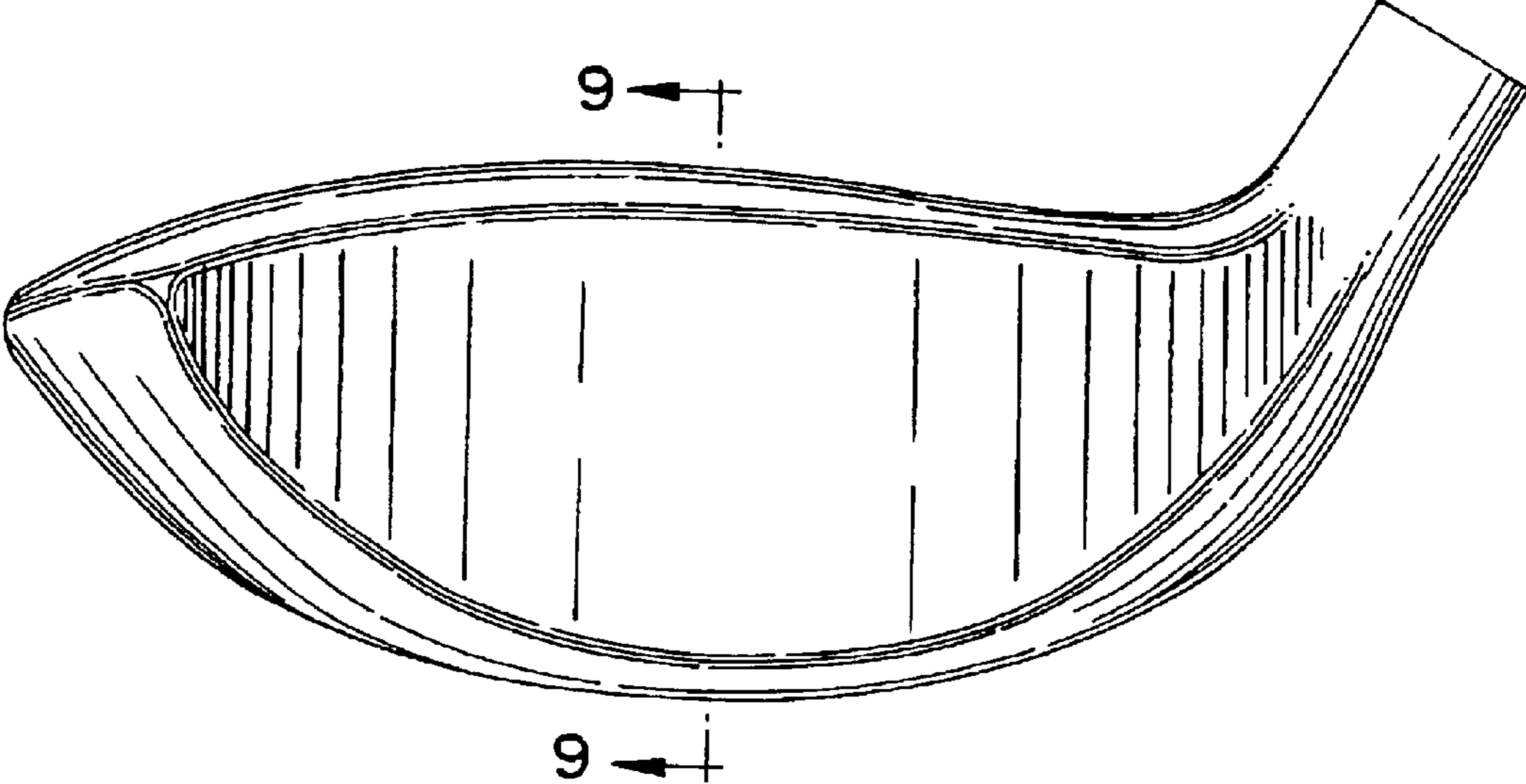

FIG. 2

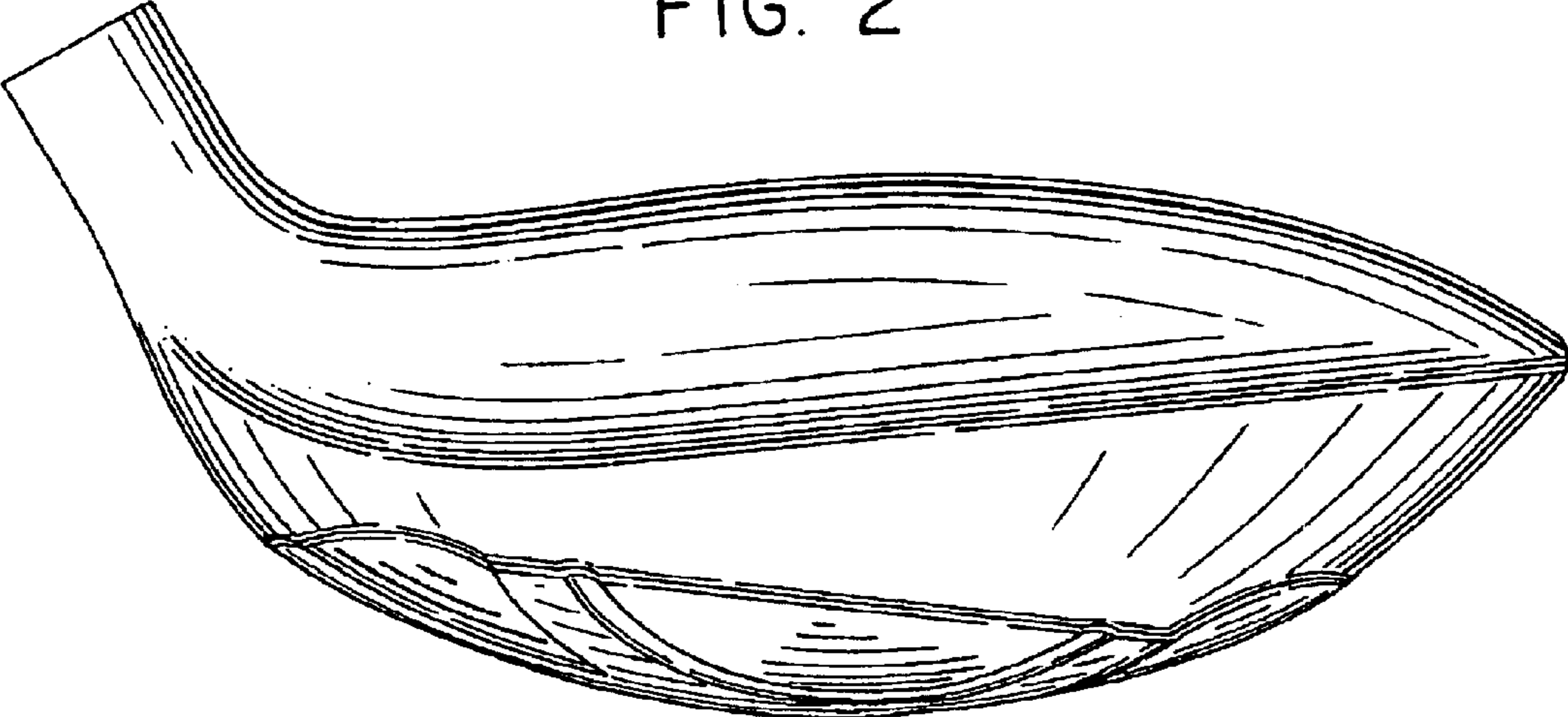

FIG. 3

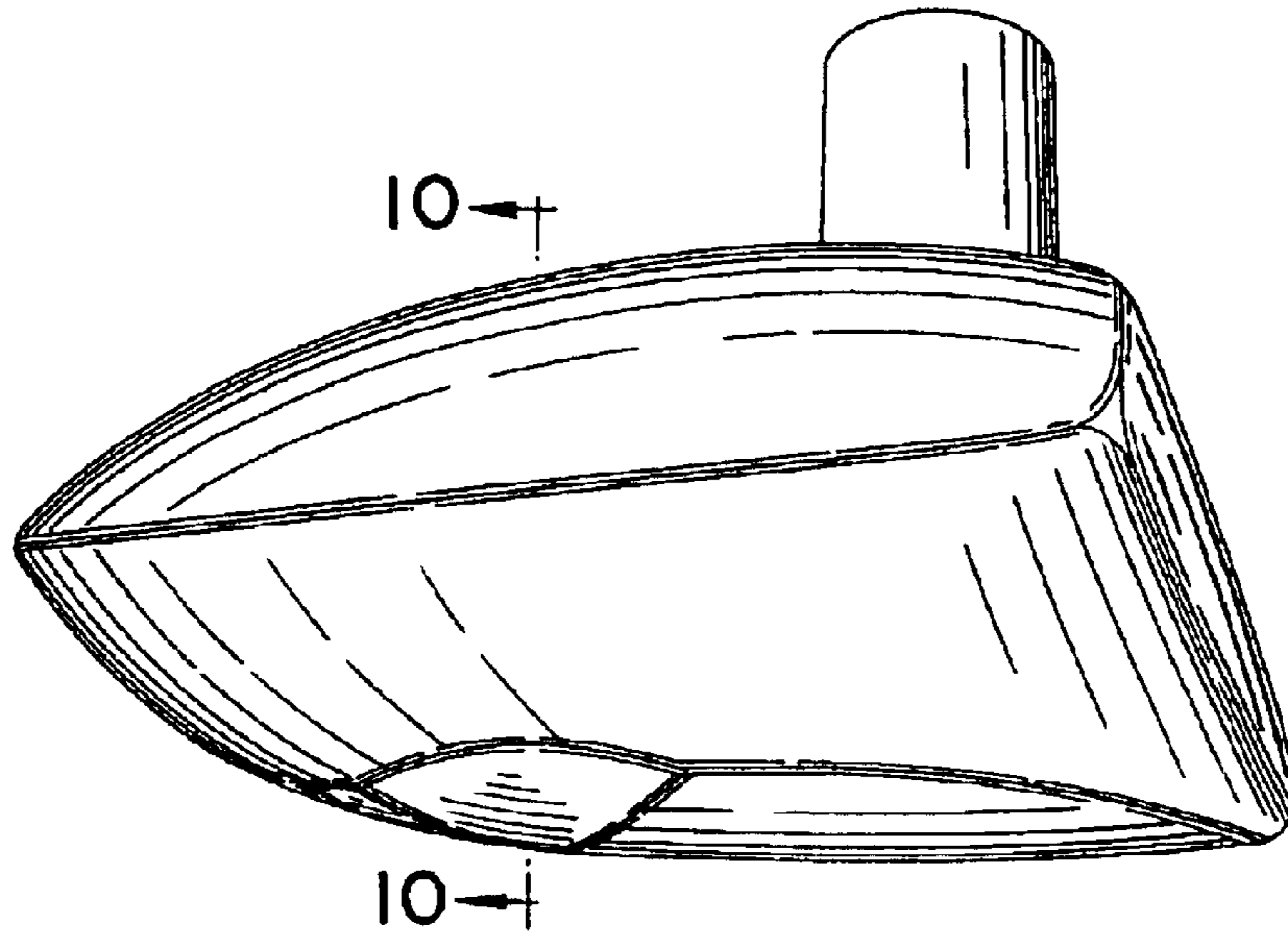

FIG. 4

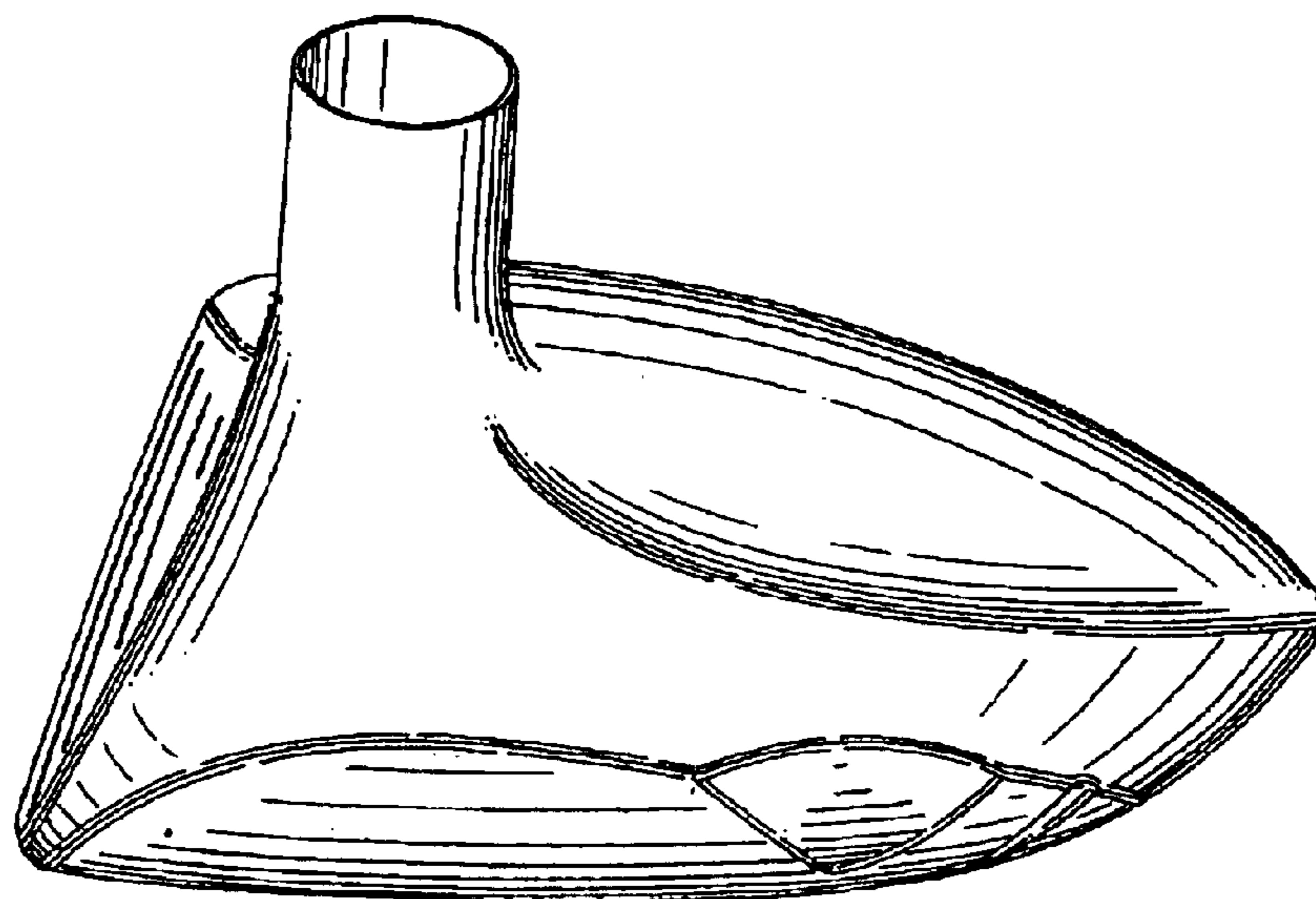

FIG. 5

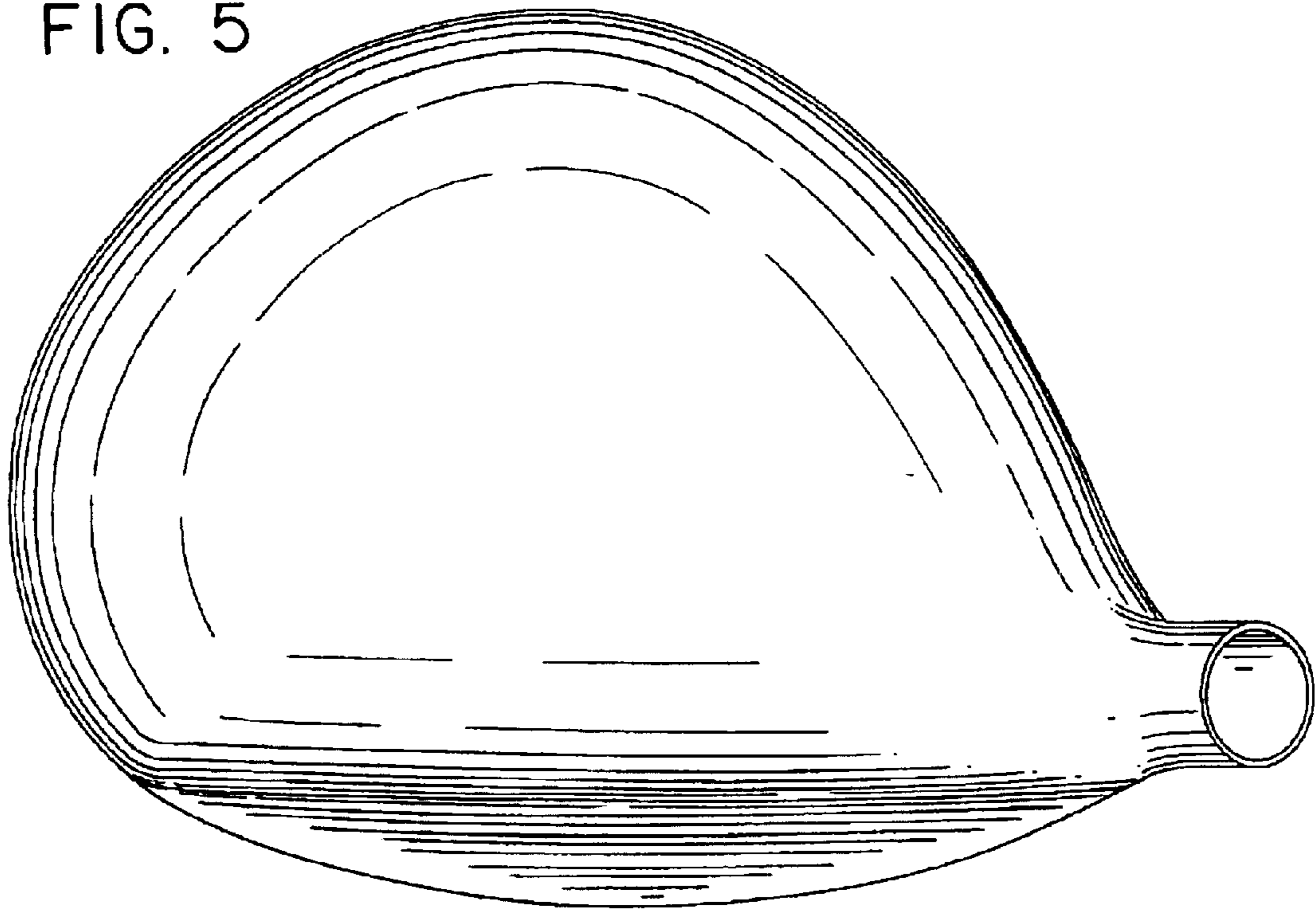

FIG. 6

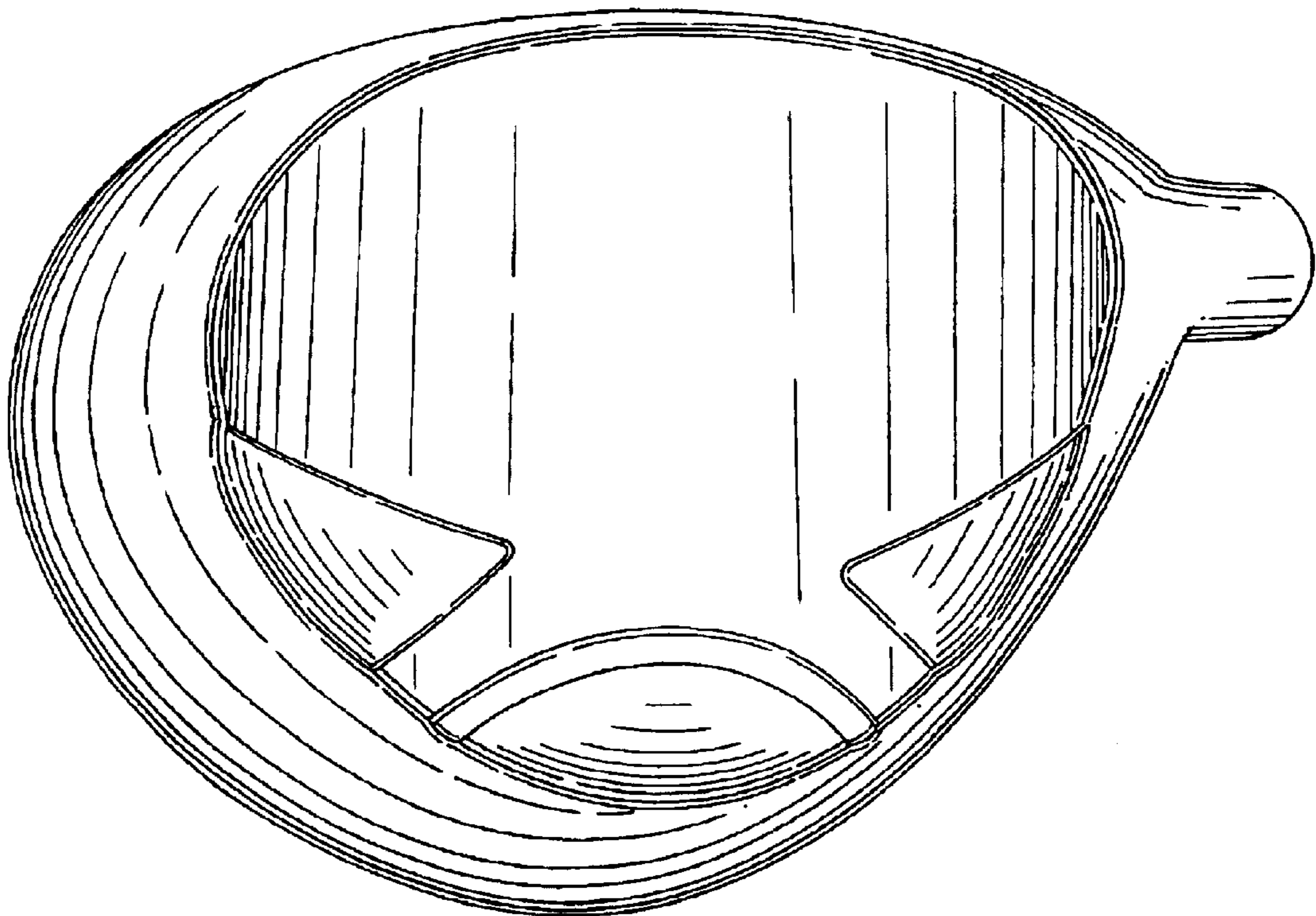

FIG. 7

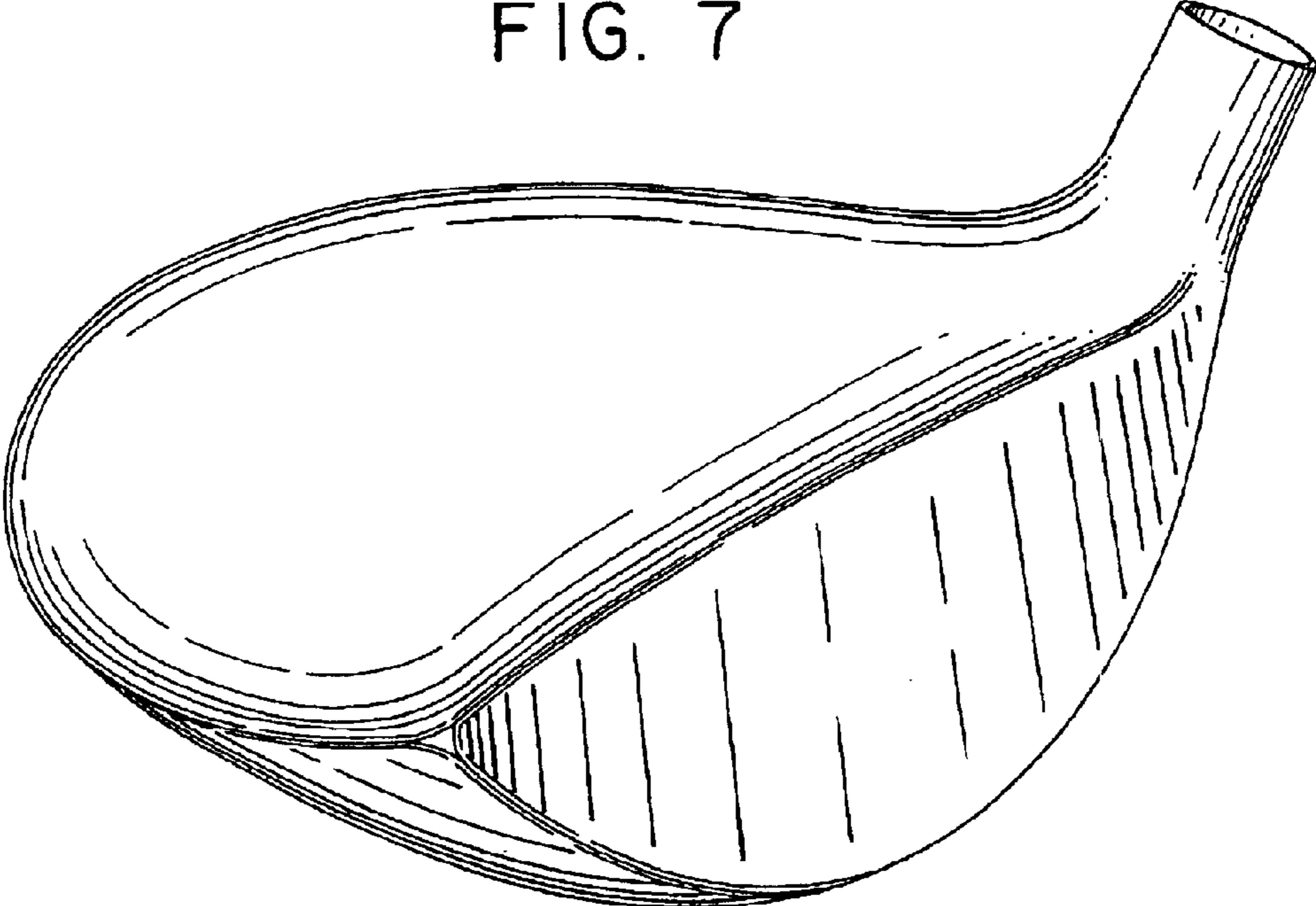

FIG. 8

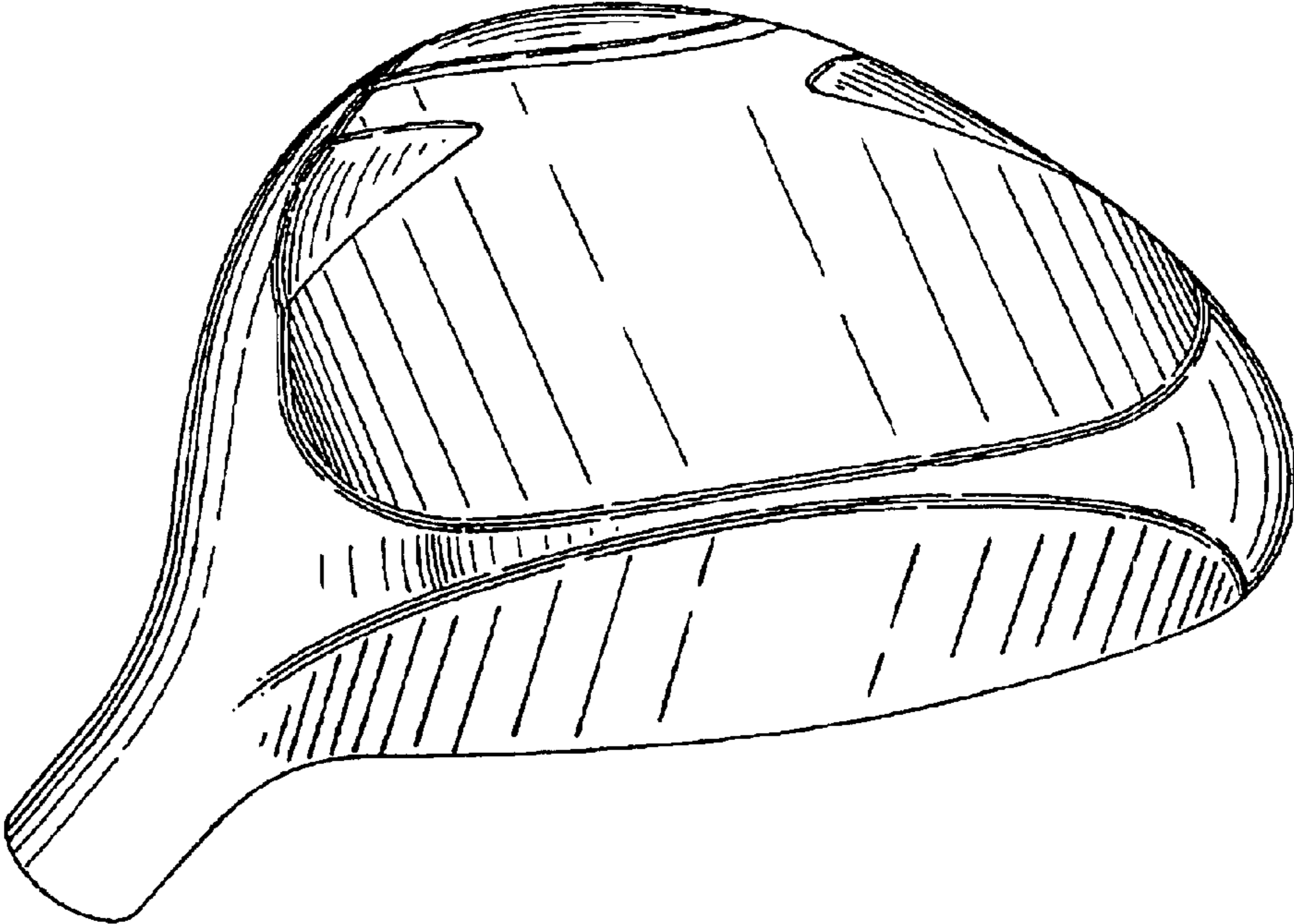

FIG. 9

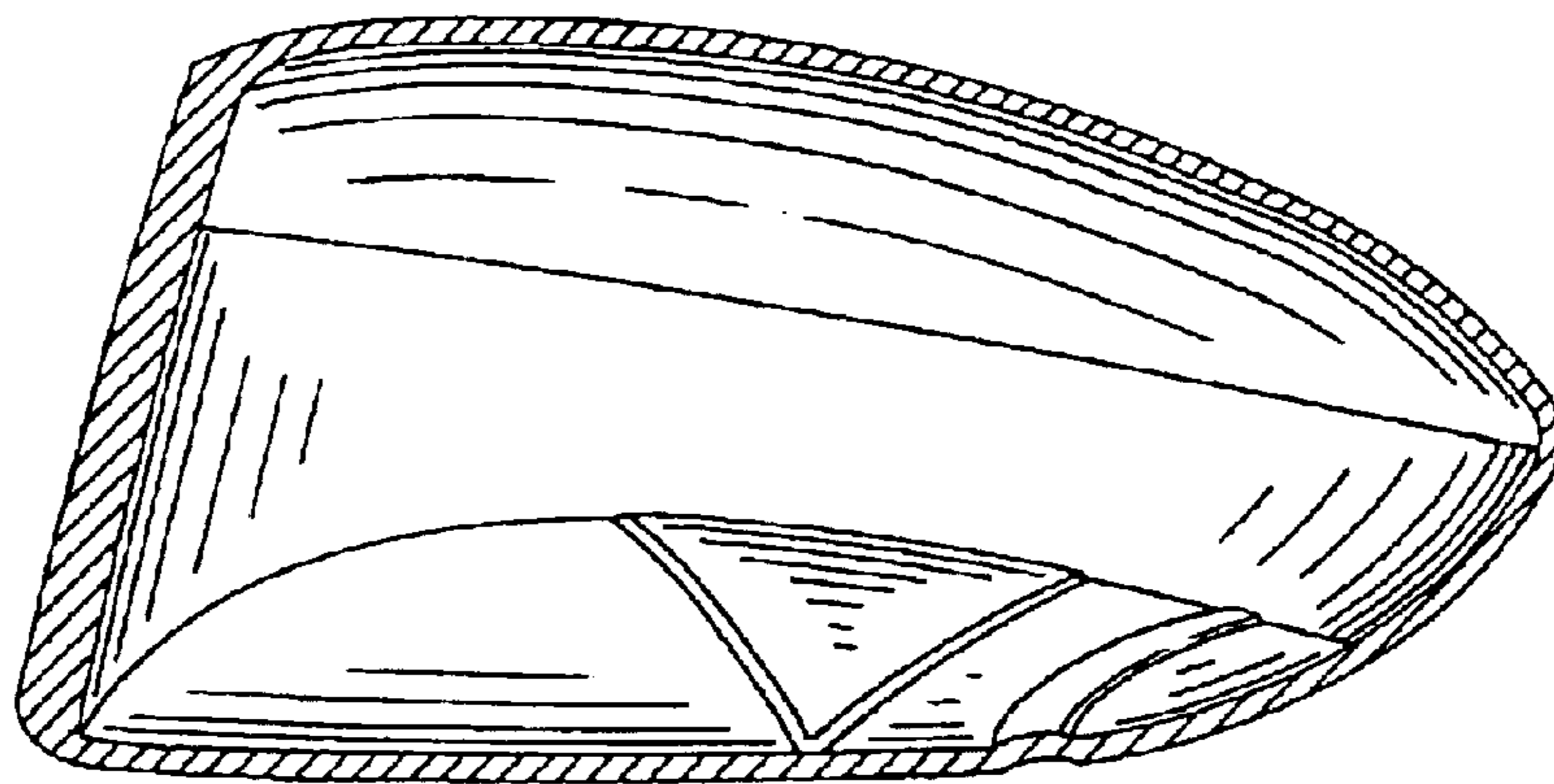

FIG. 10

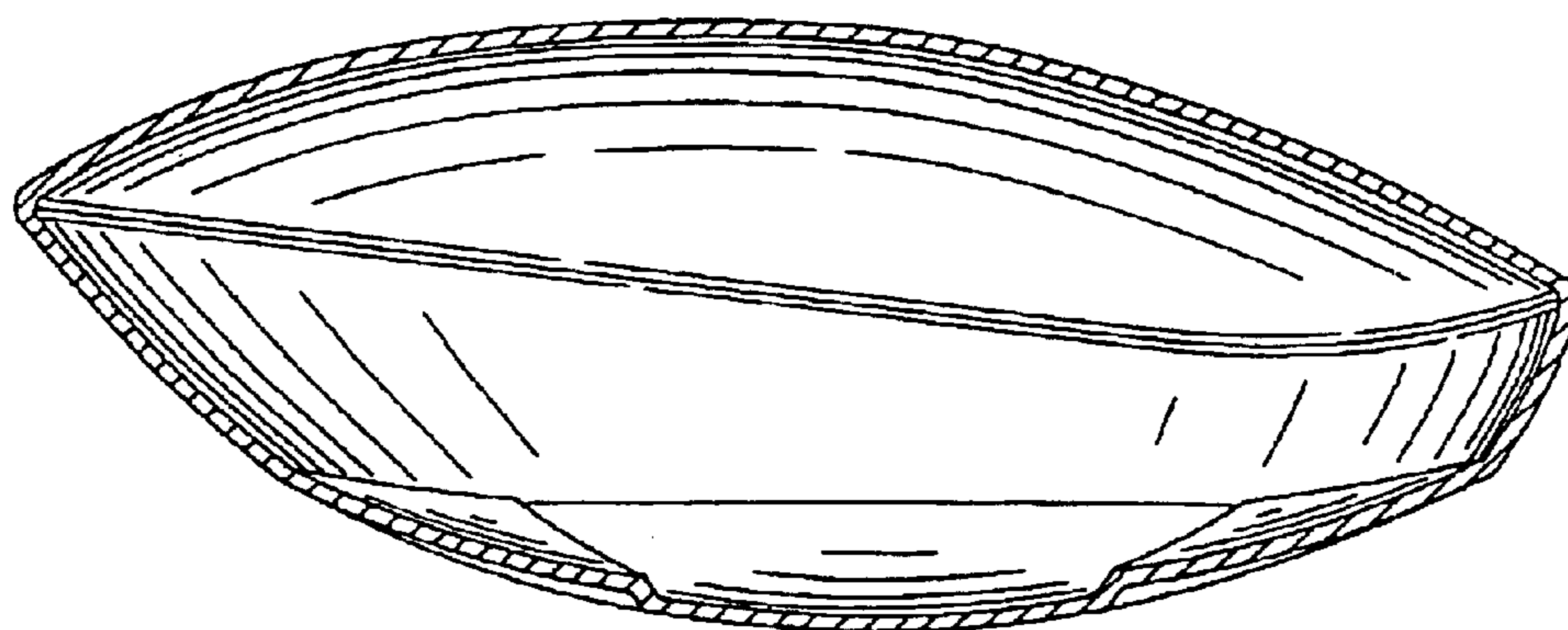

FIG. 11

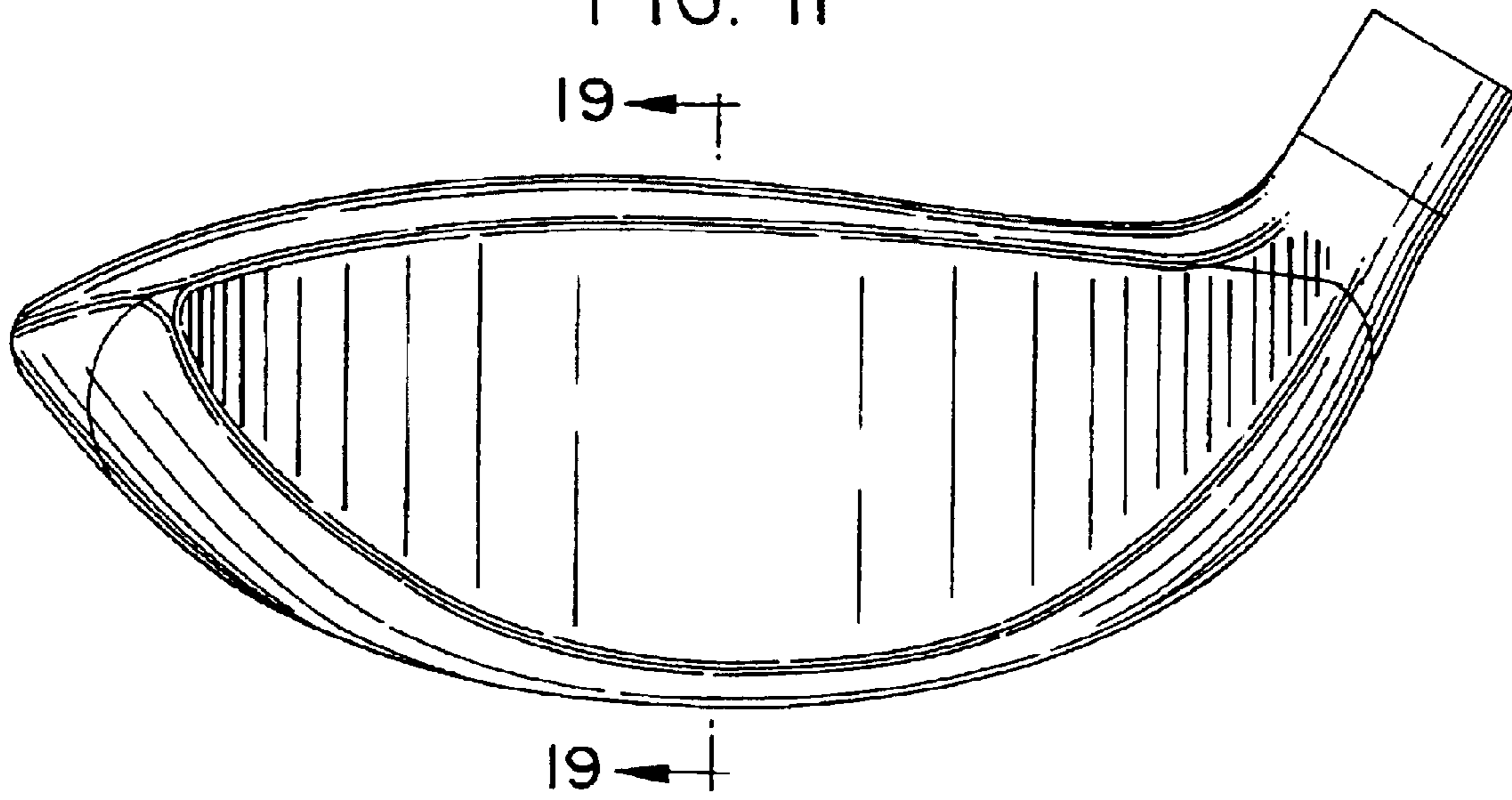

FIG. 12

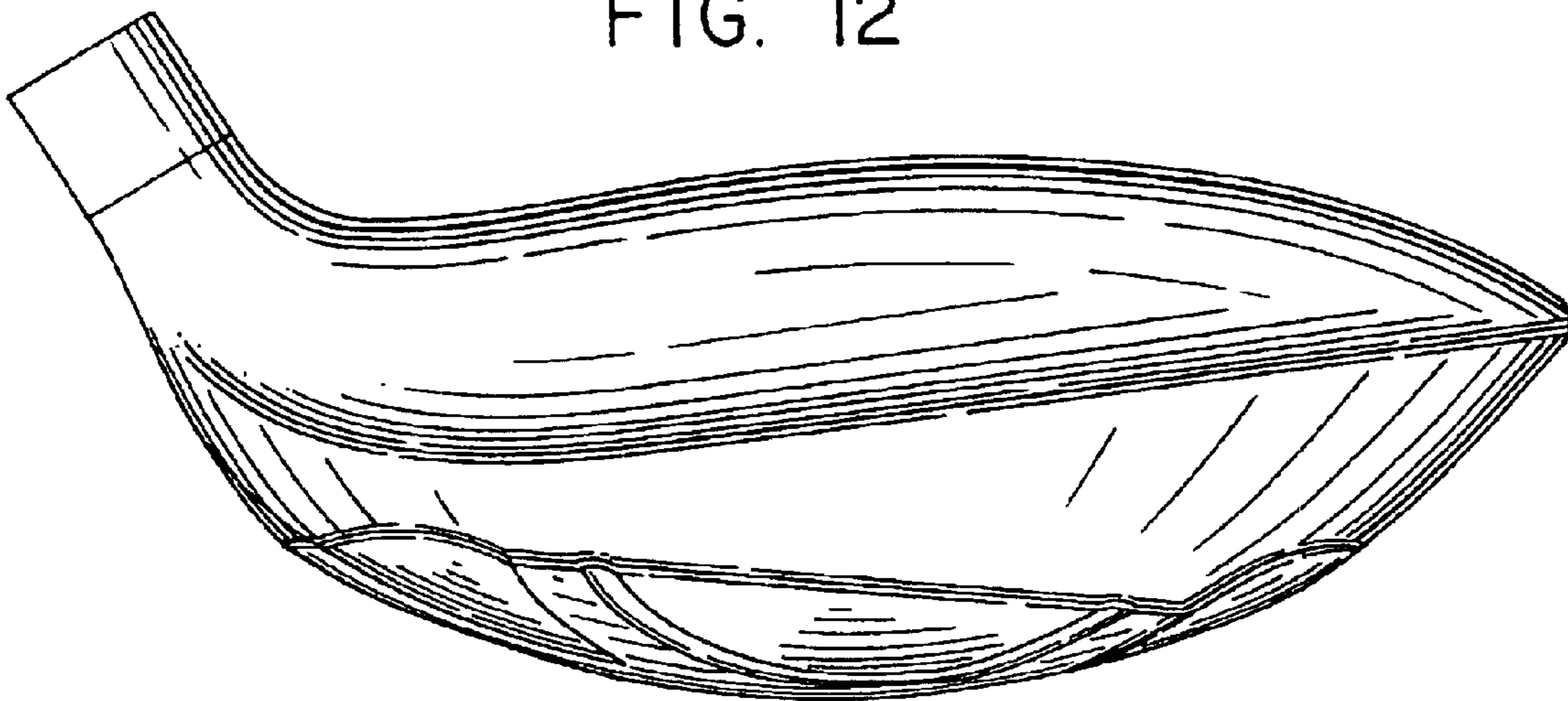

FIG. 13

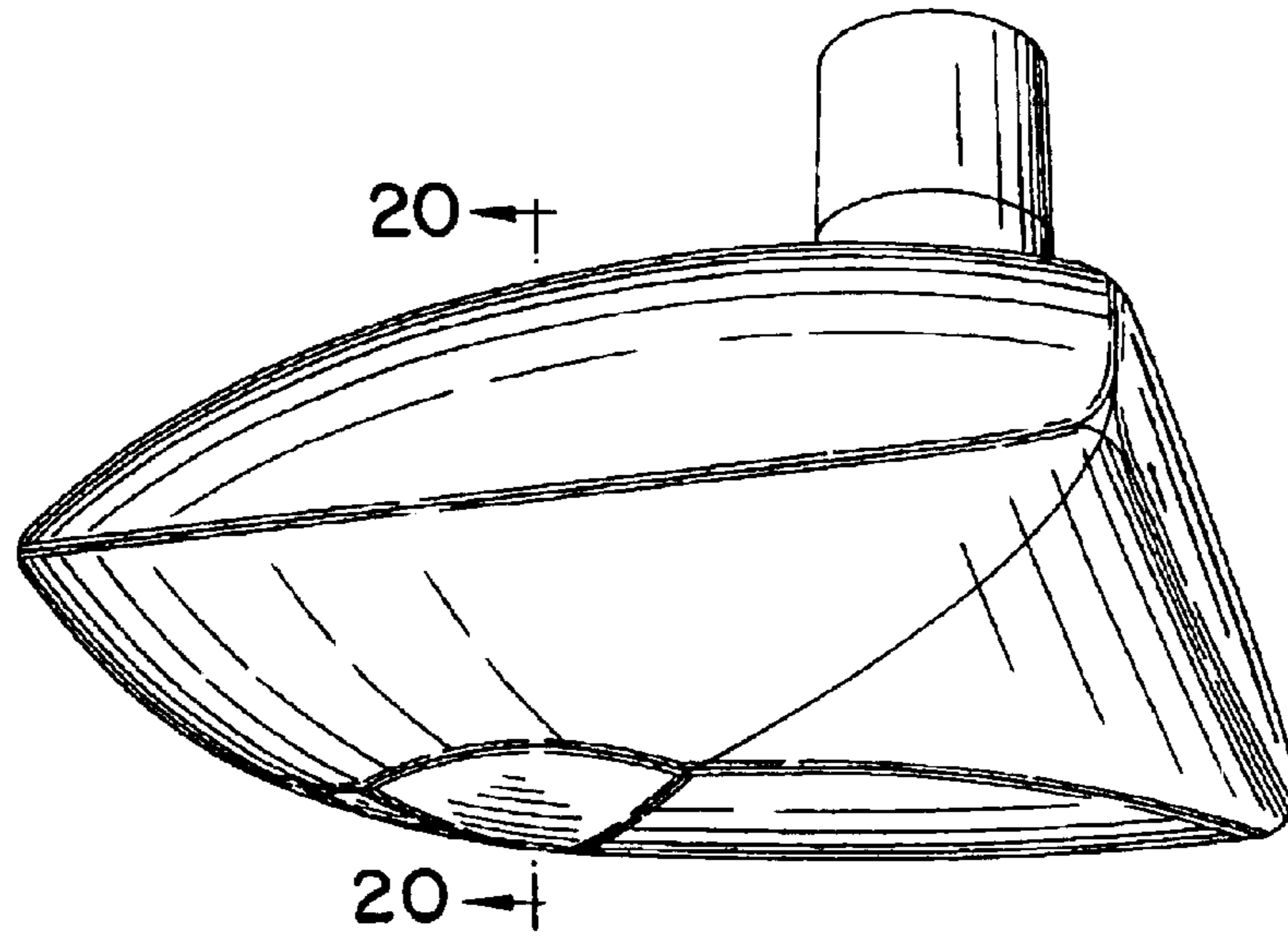

FIG. 14

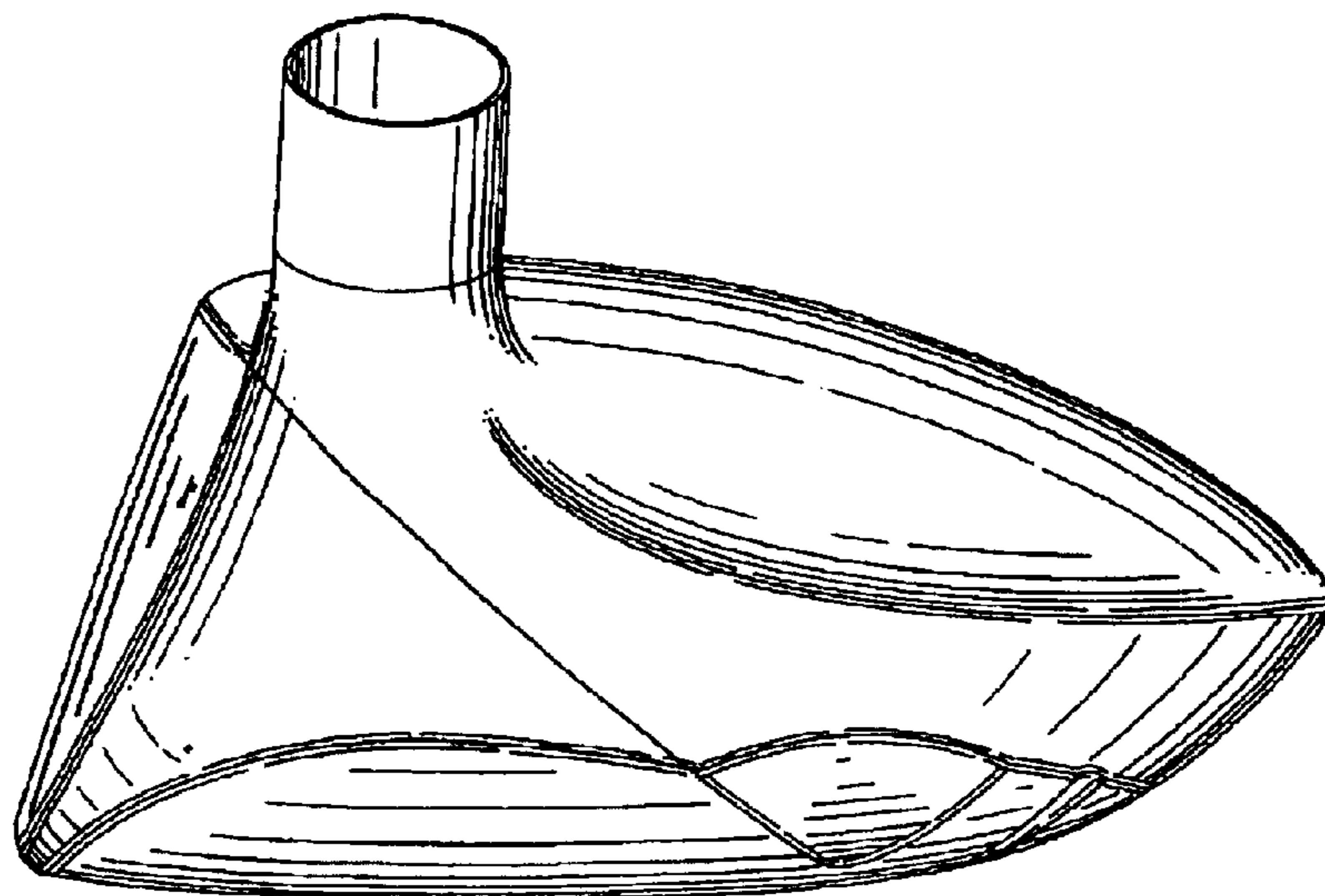

FIG. 15

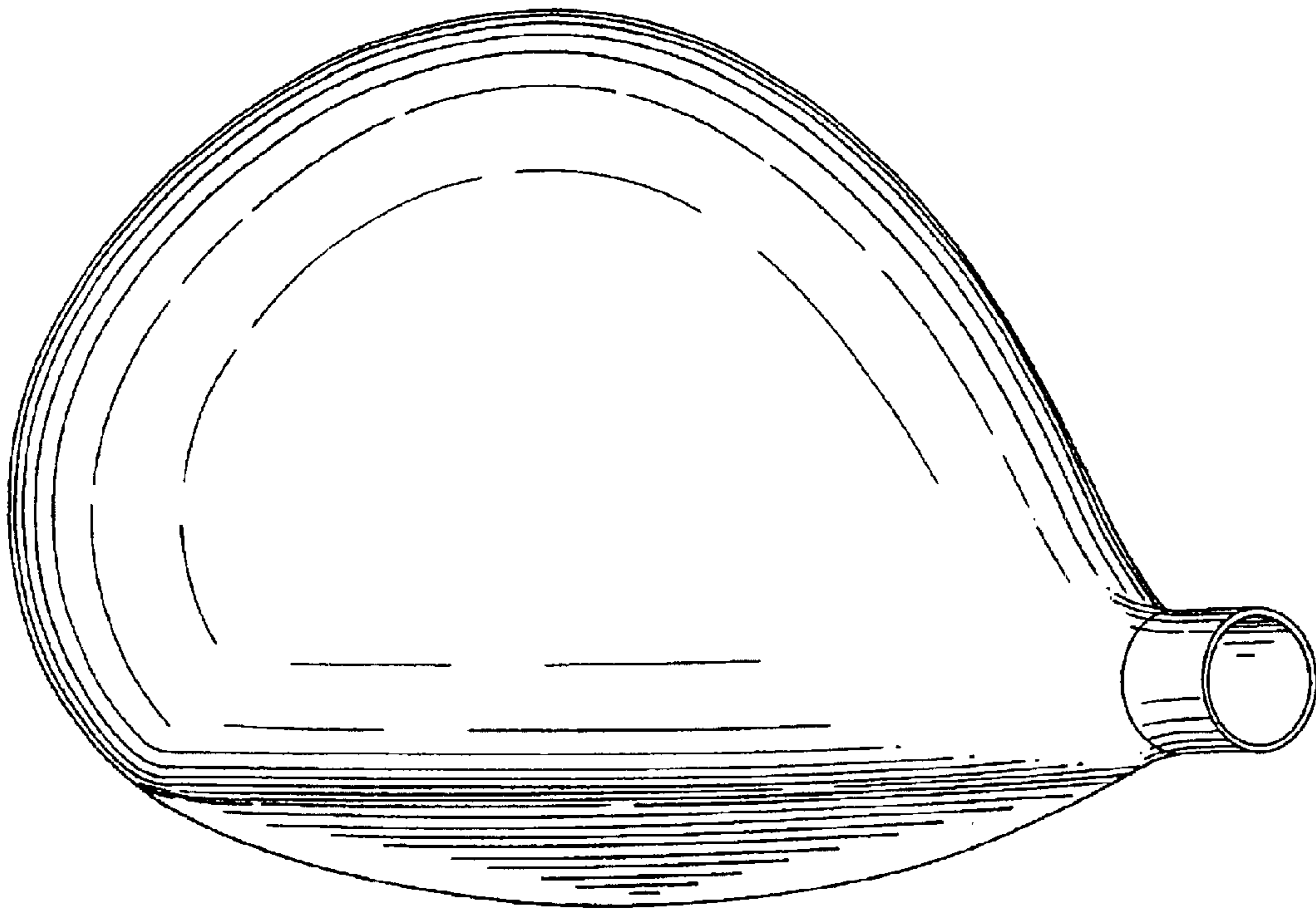

FIG. 16

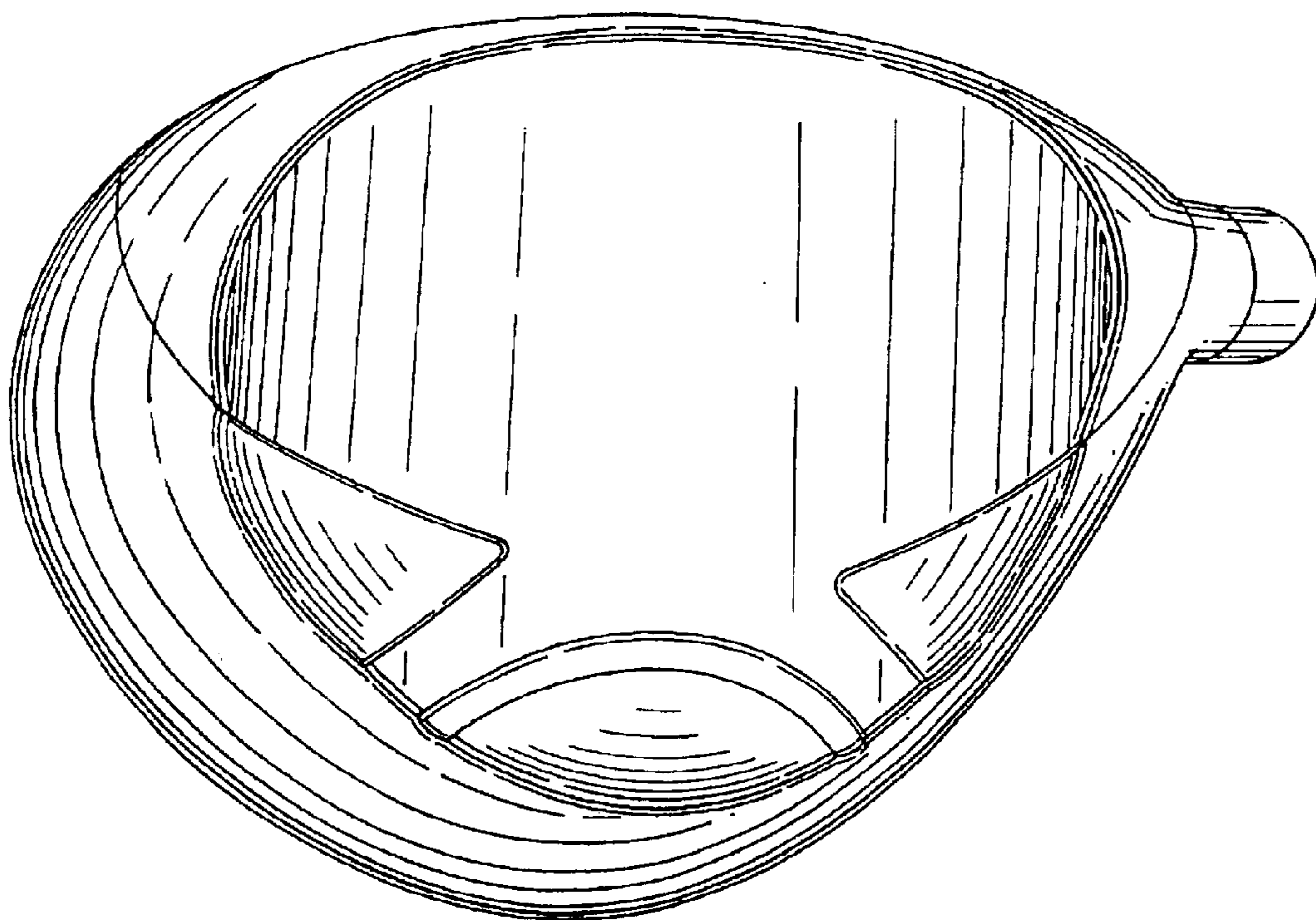

FIG. 17

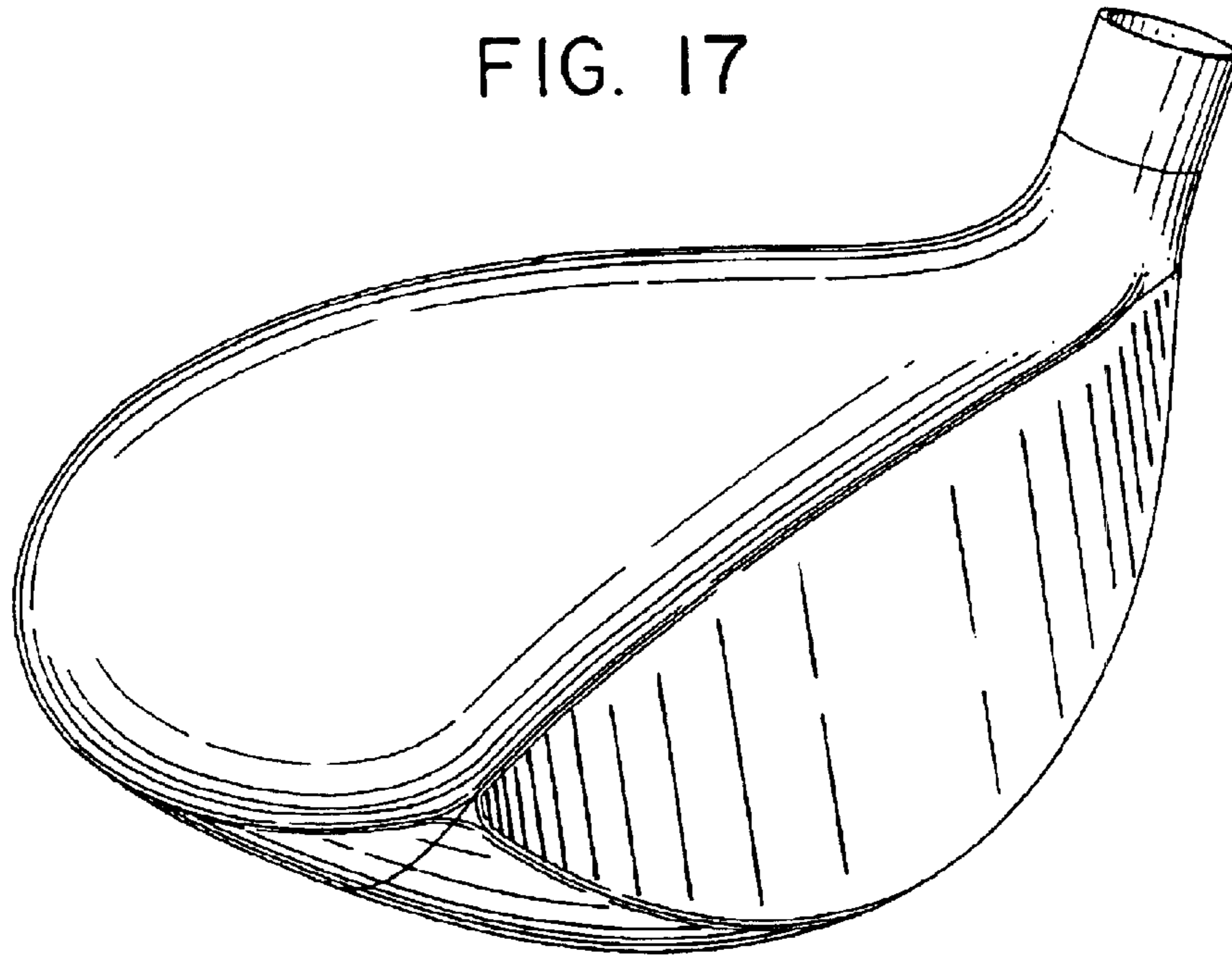

FIG. 18

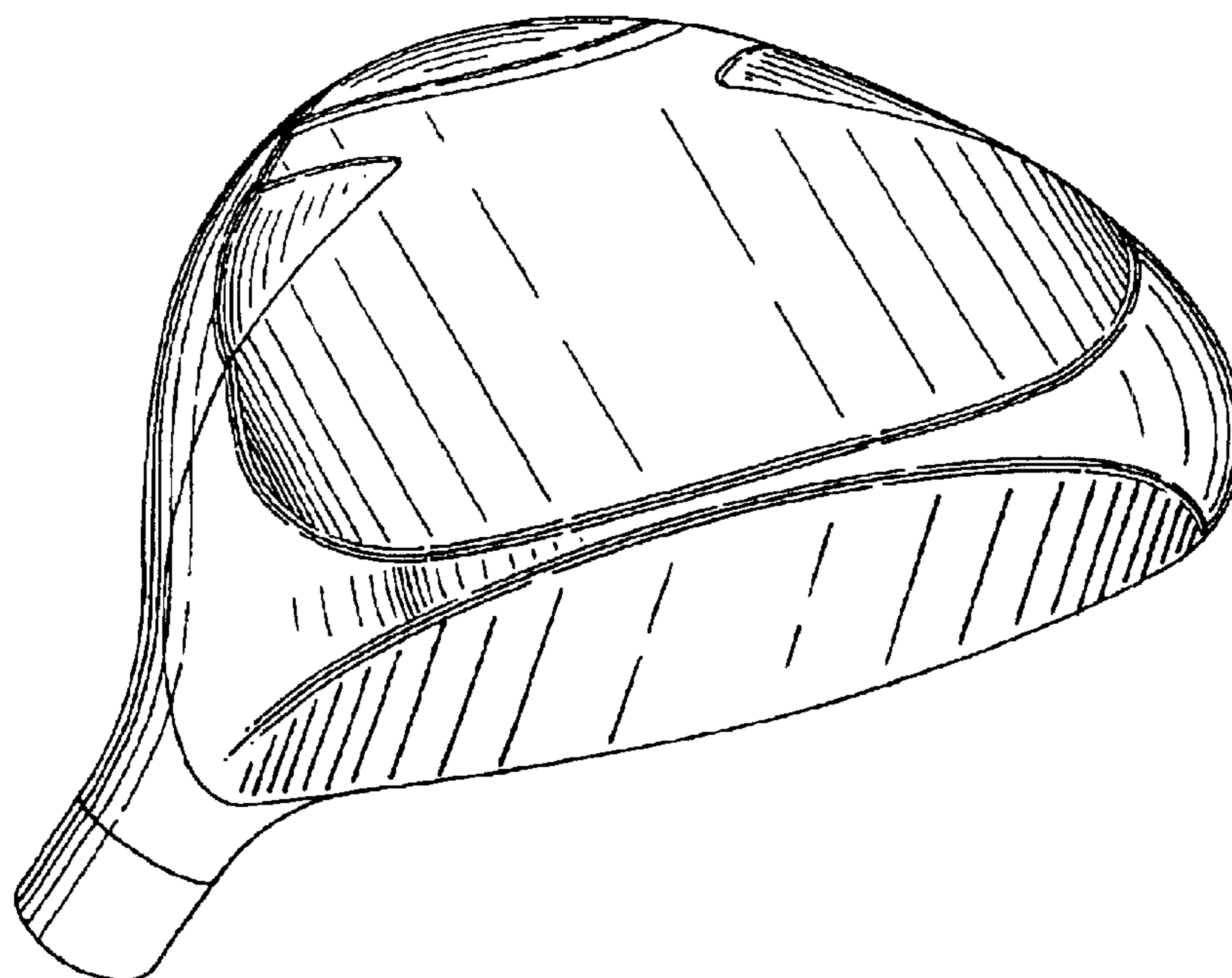

FIG. 19

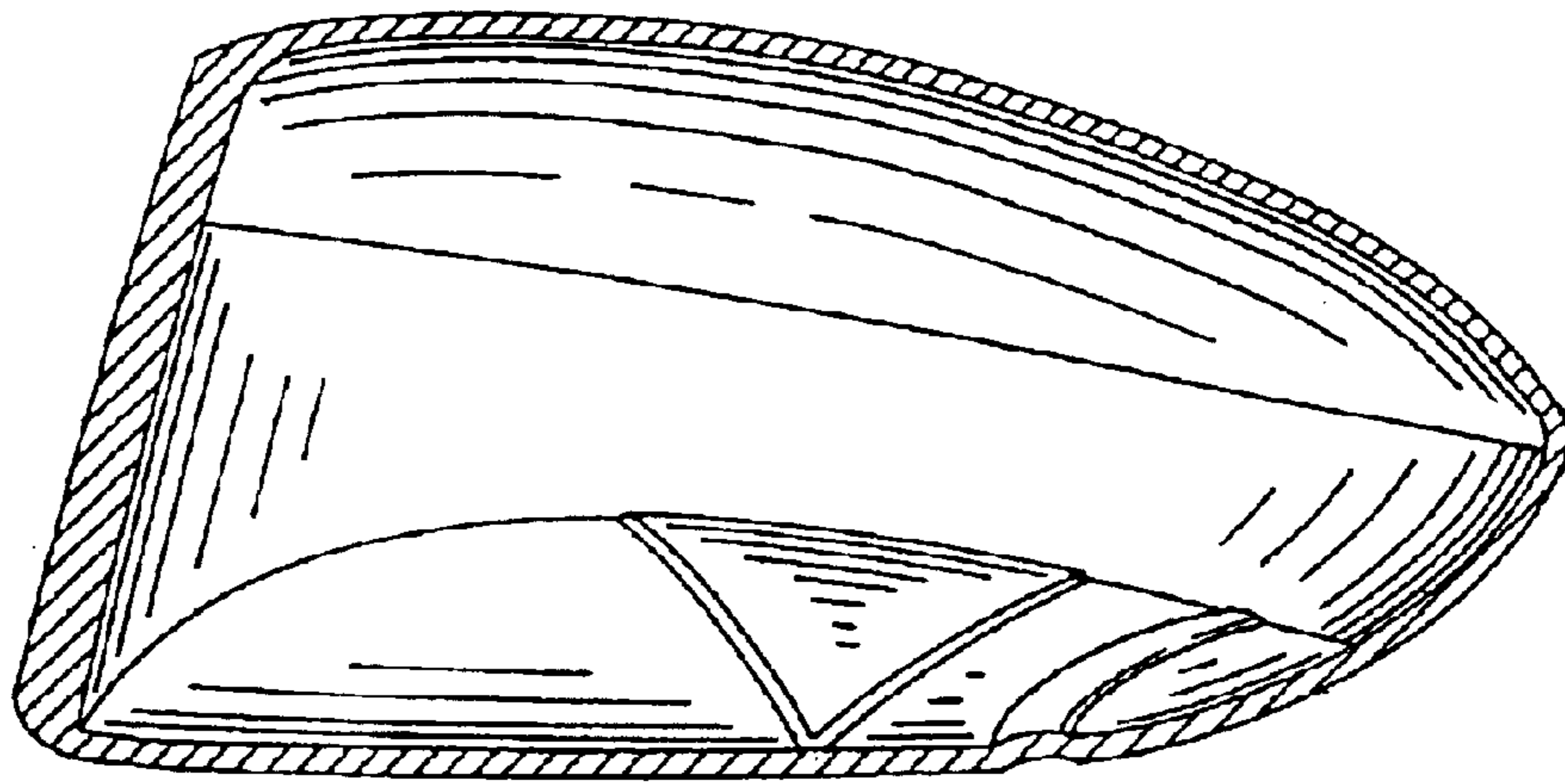

FIG. 20

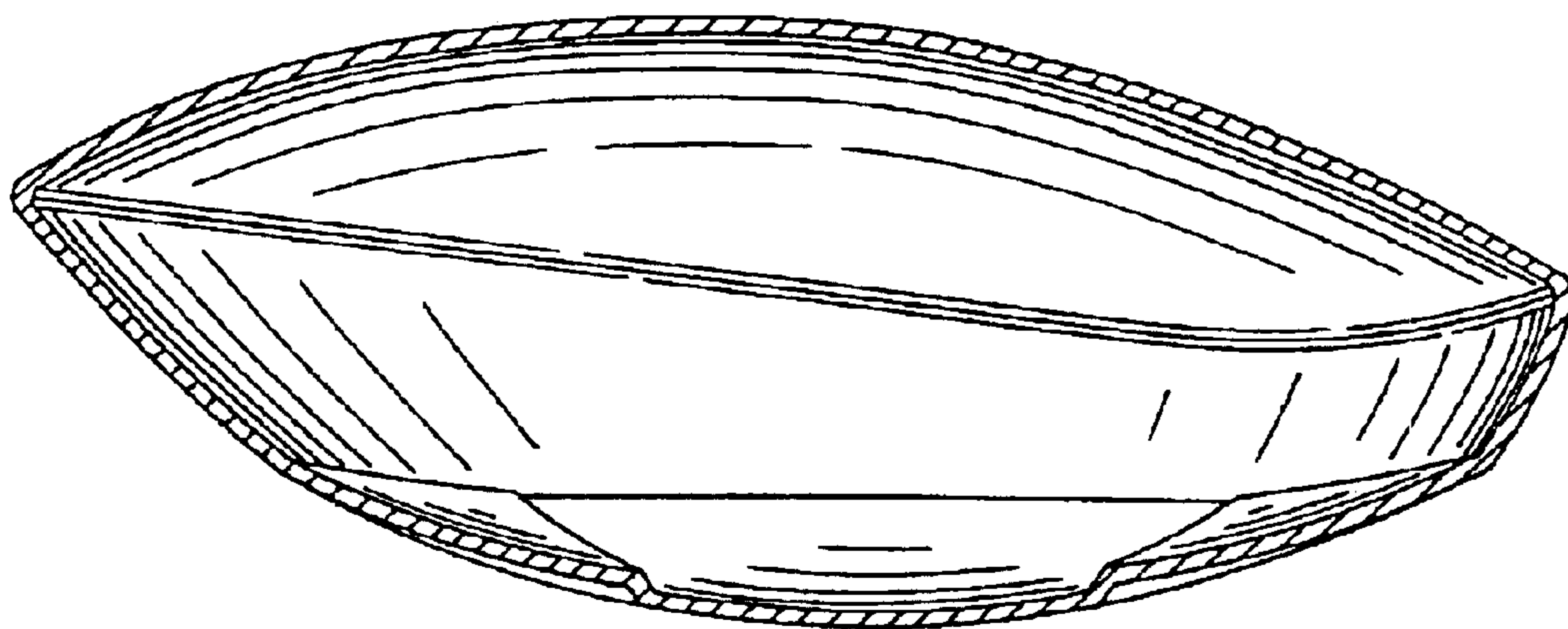

FIG. 21

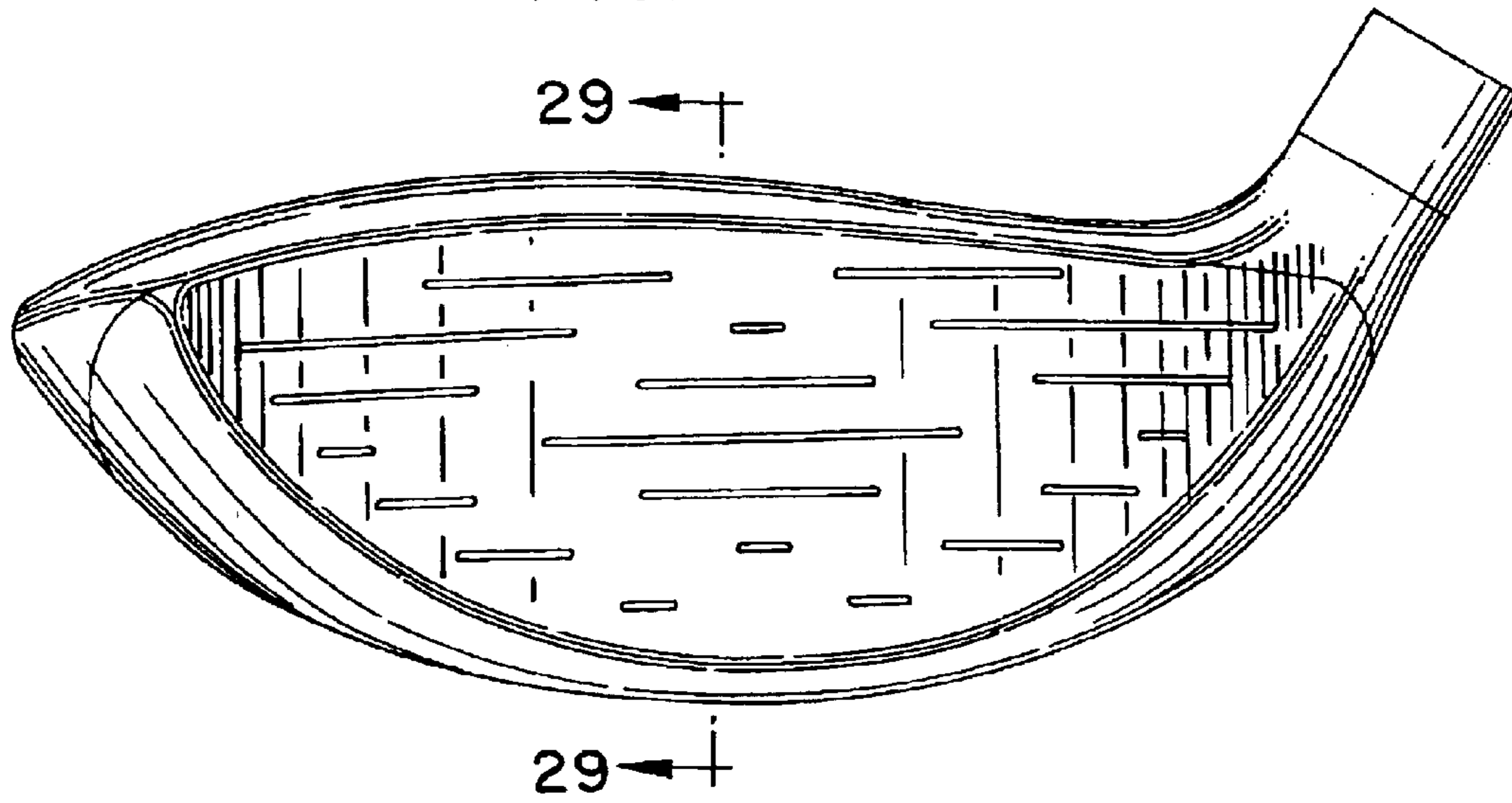

FIG. 22

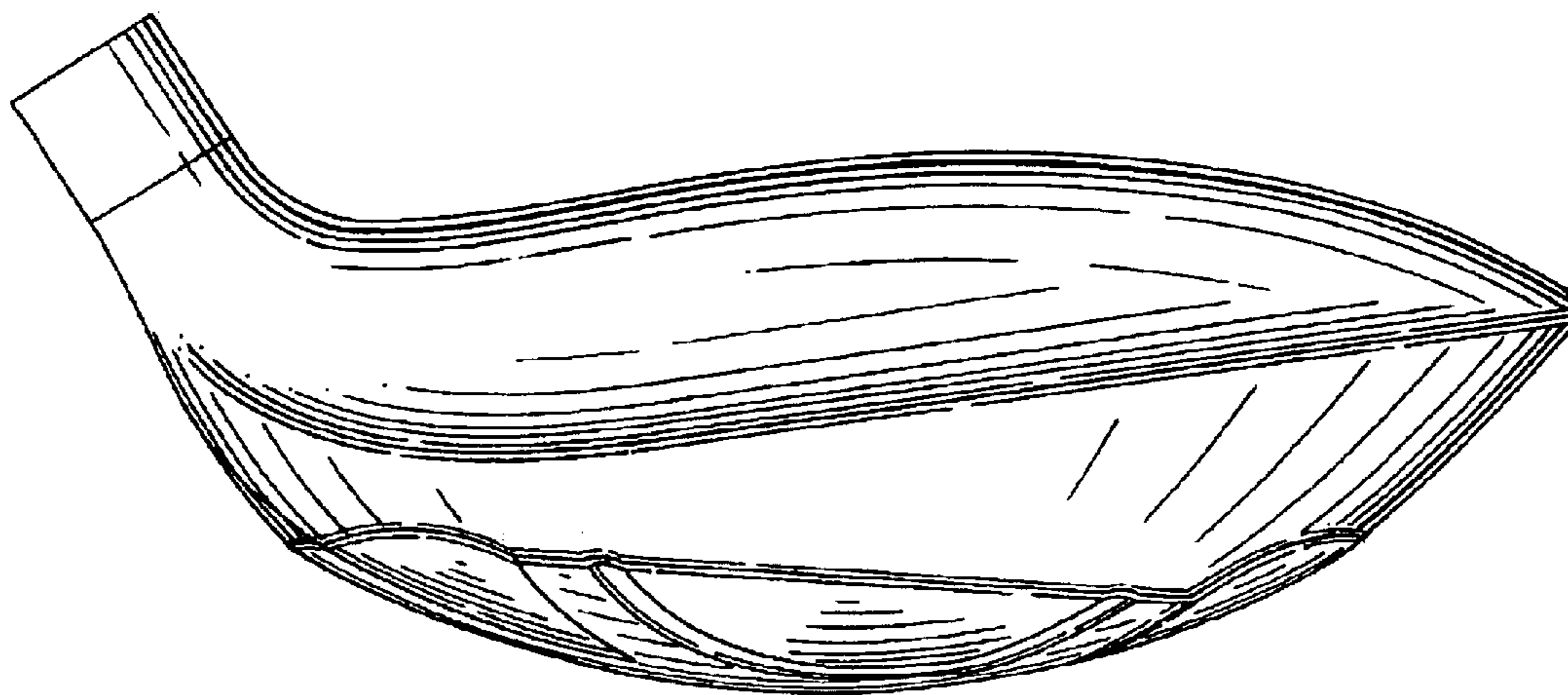

FIG. 23

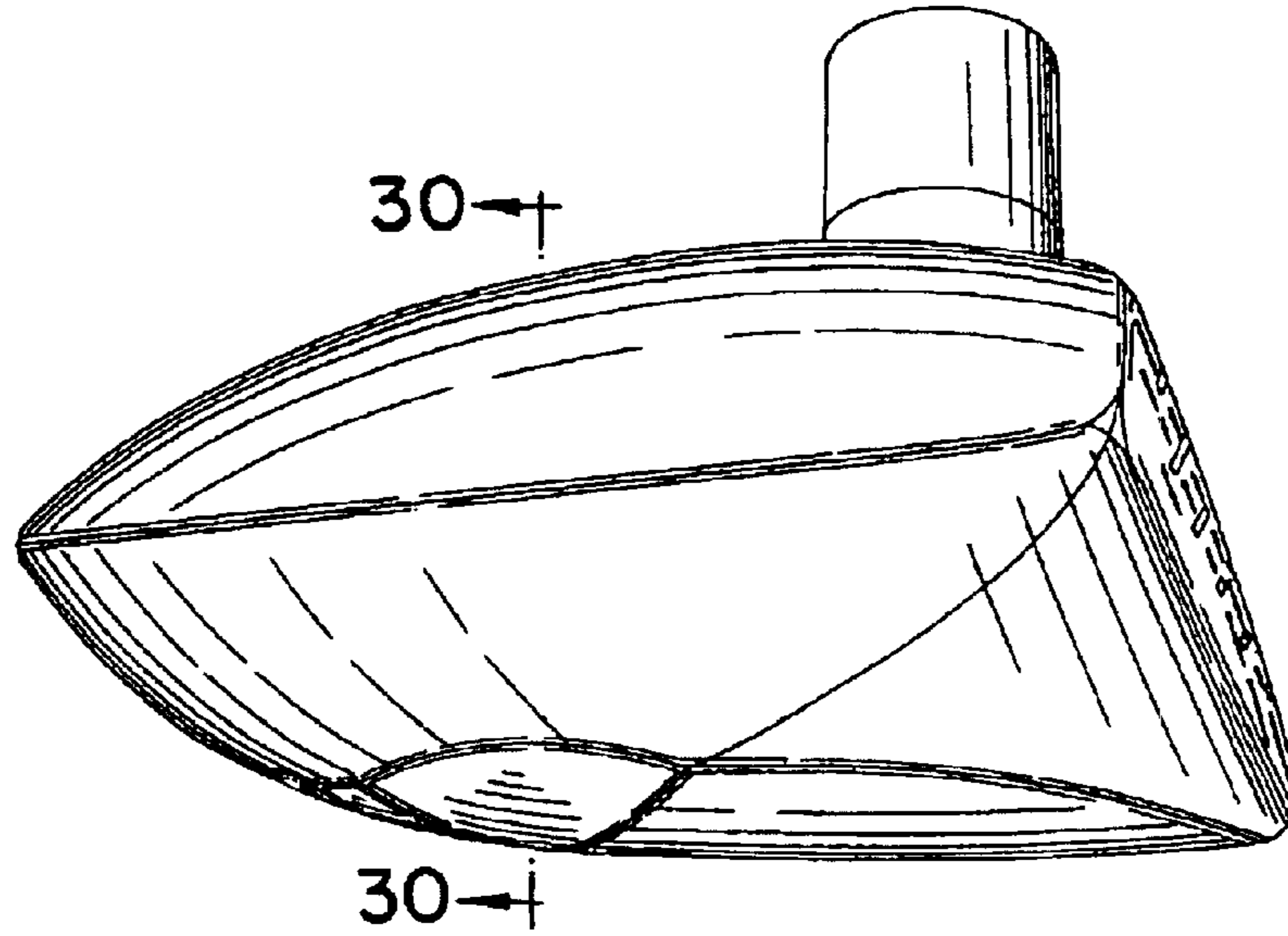

FIG. 24

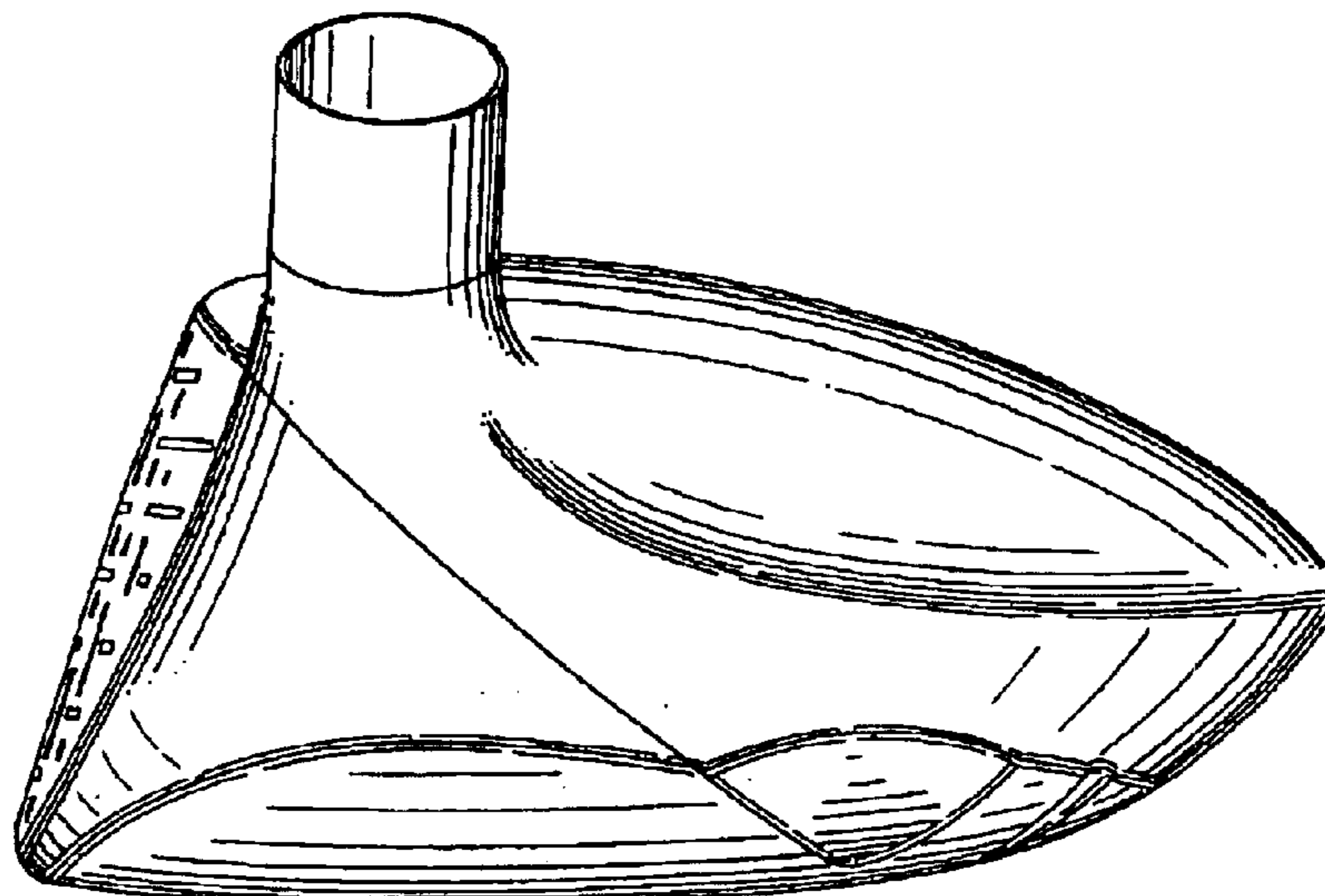

FIG. 25

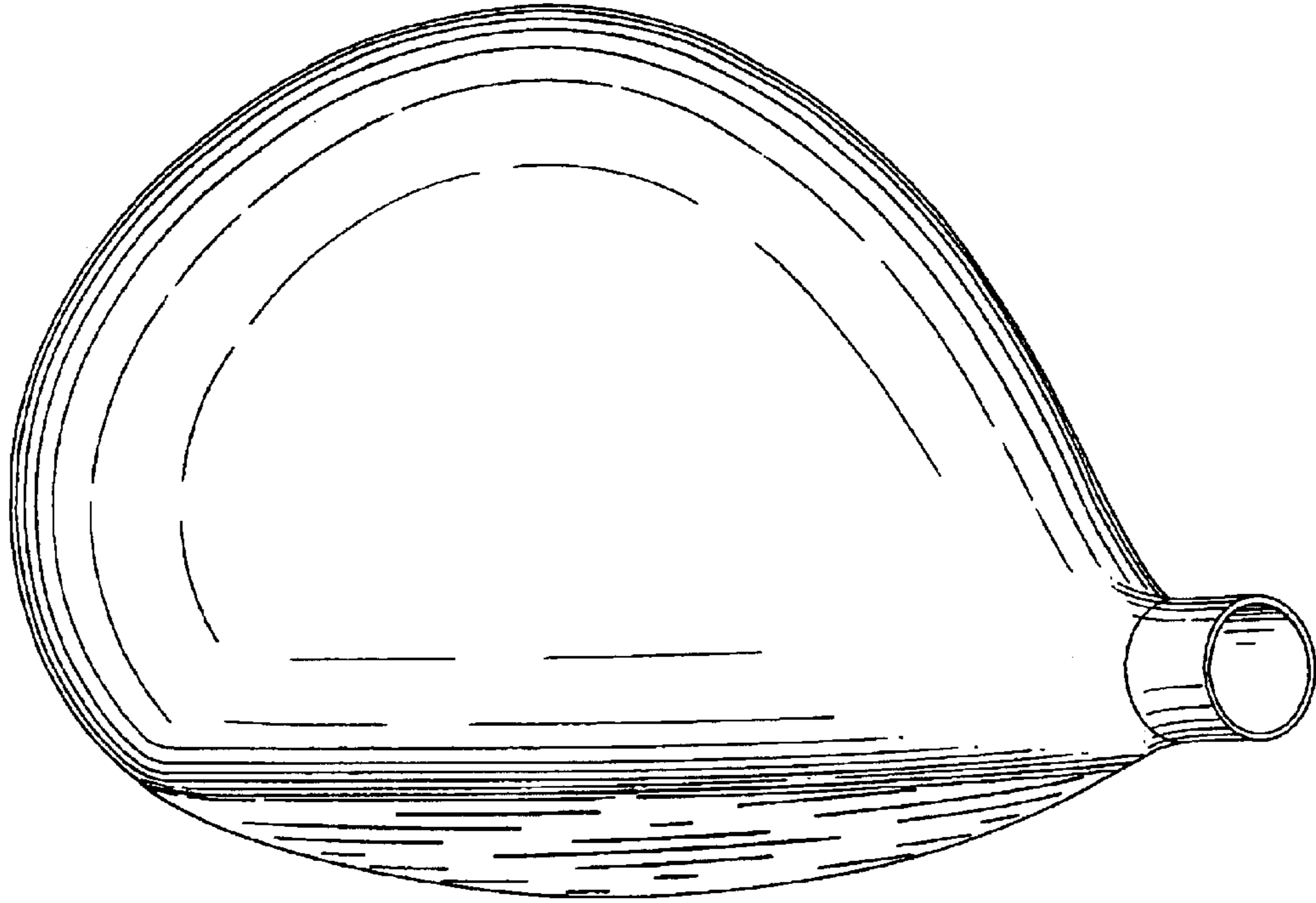

FIG. 26

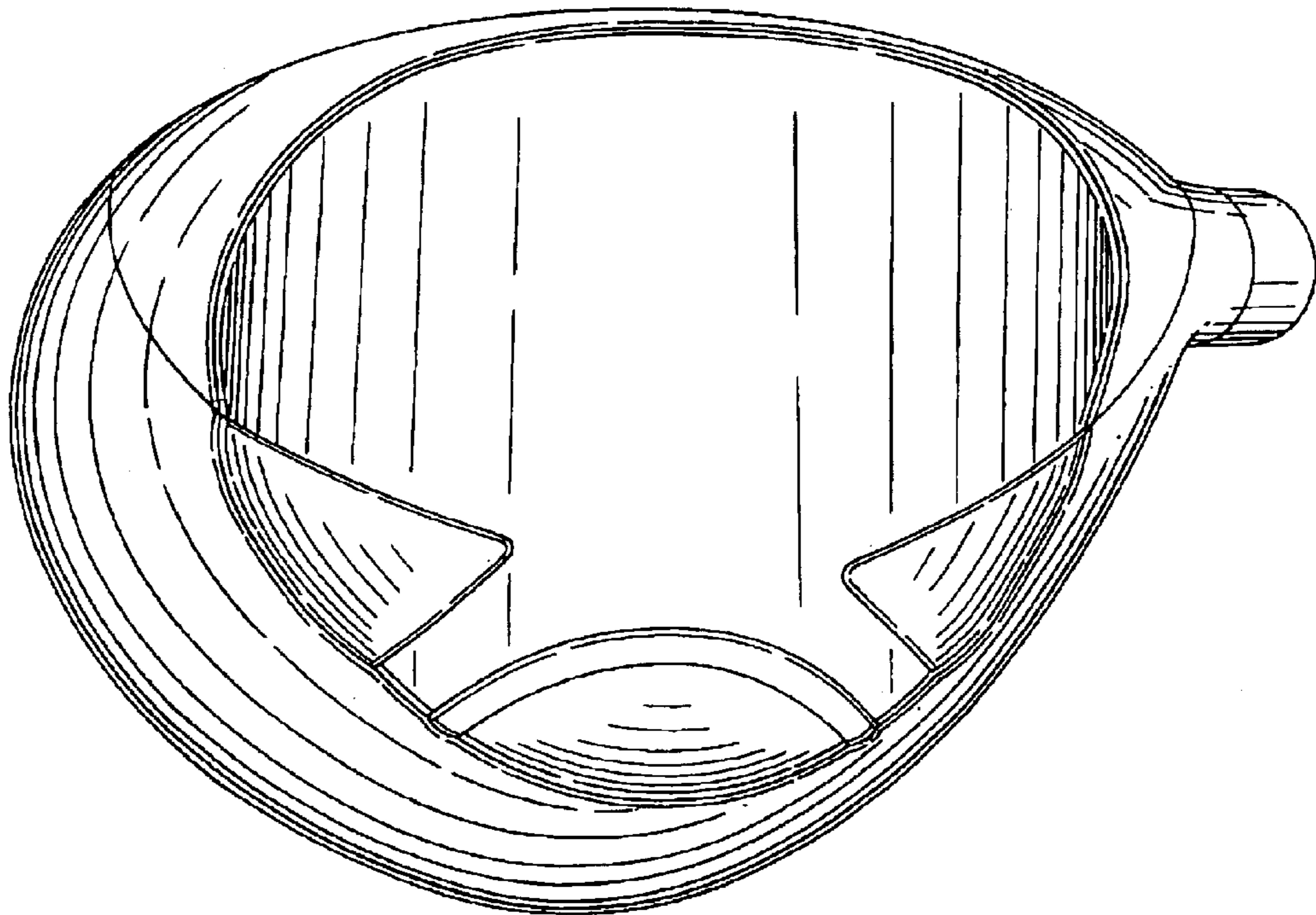

FIG. 27

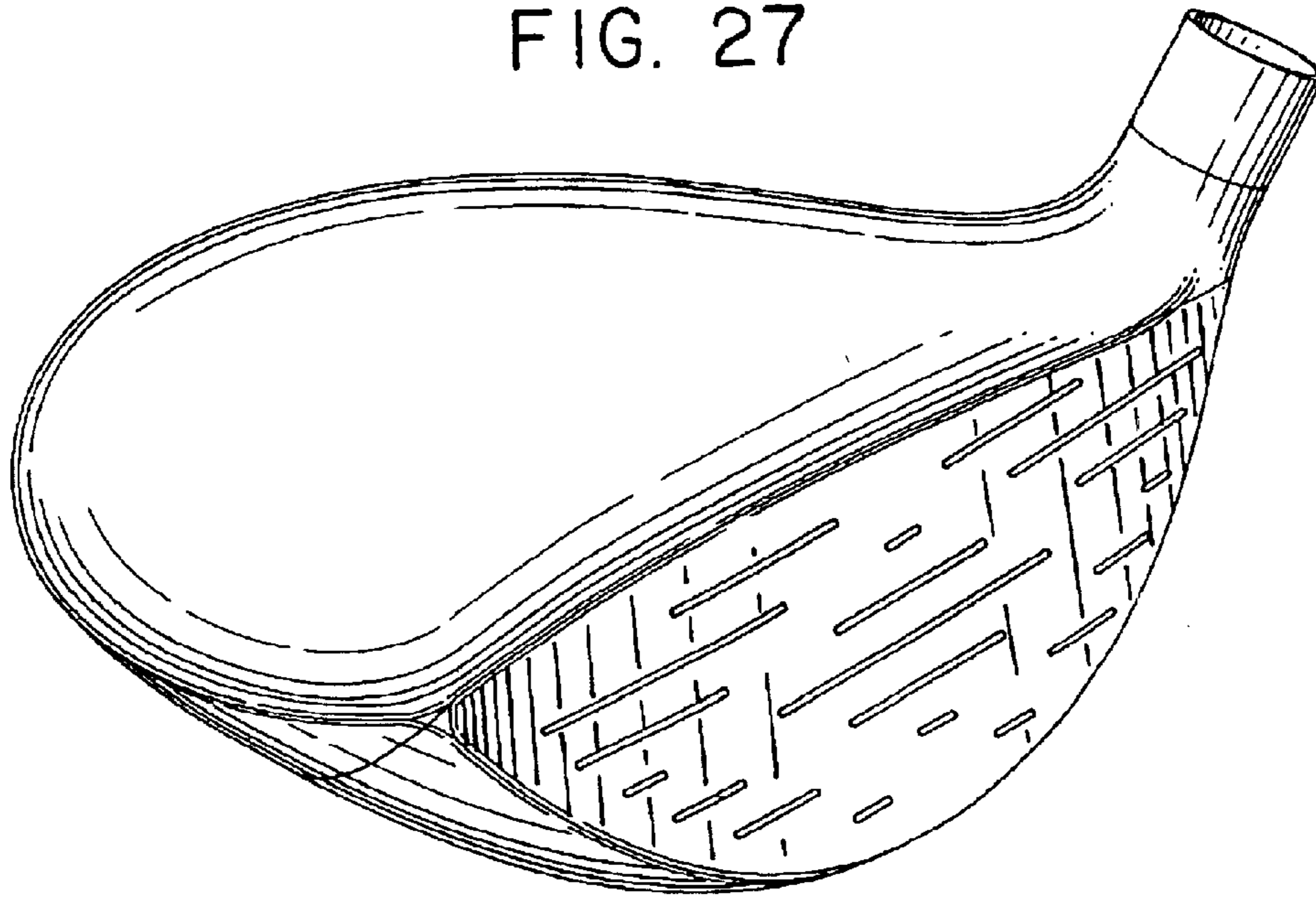

FIG. 28

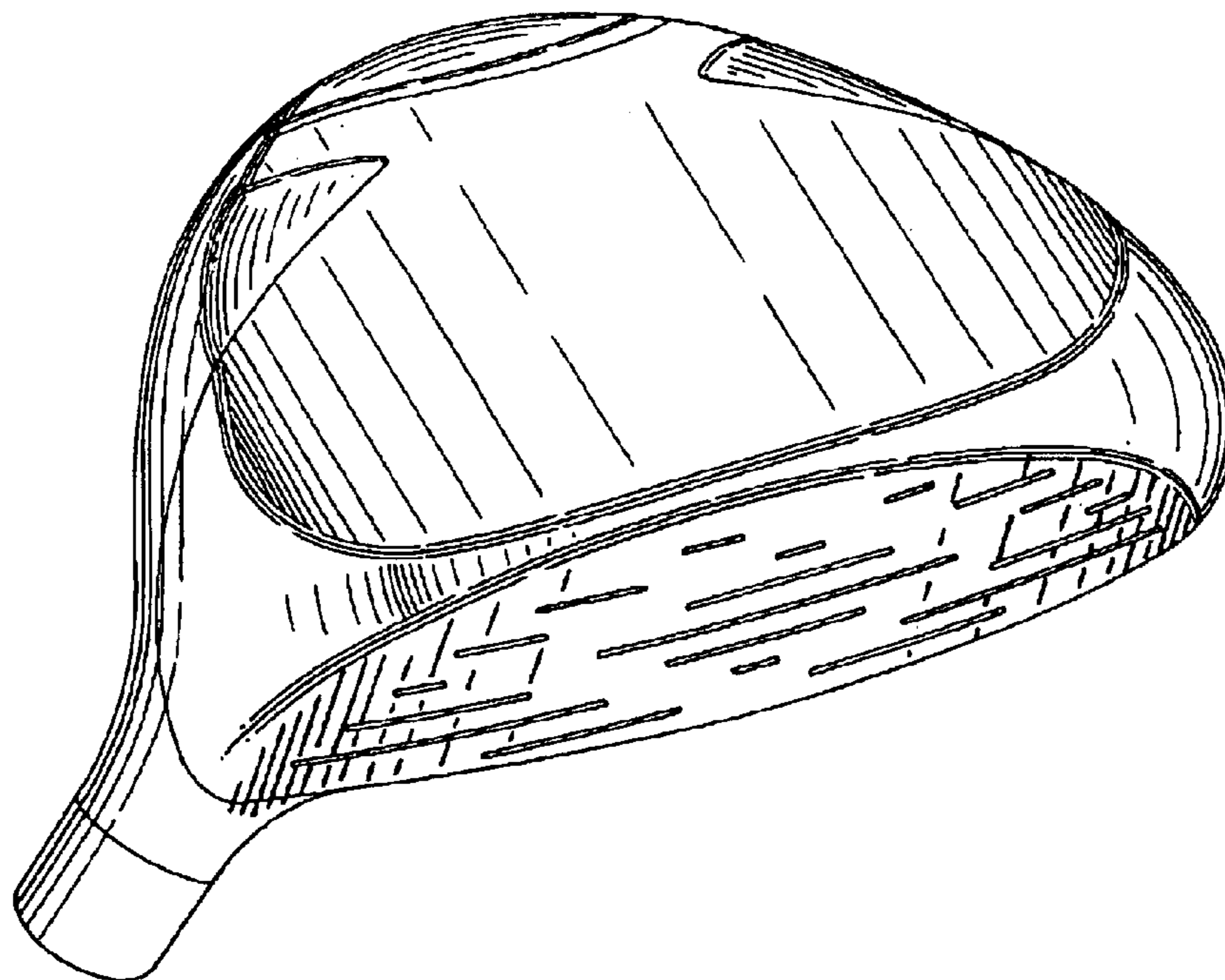

FIG. 29

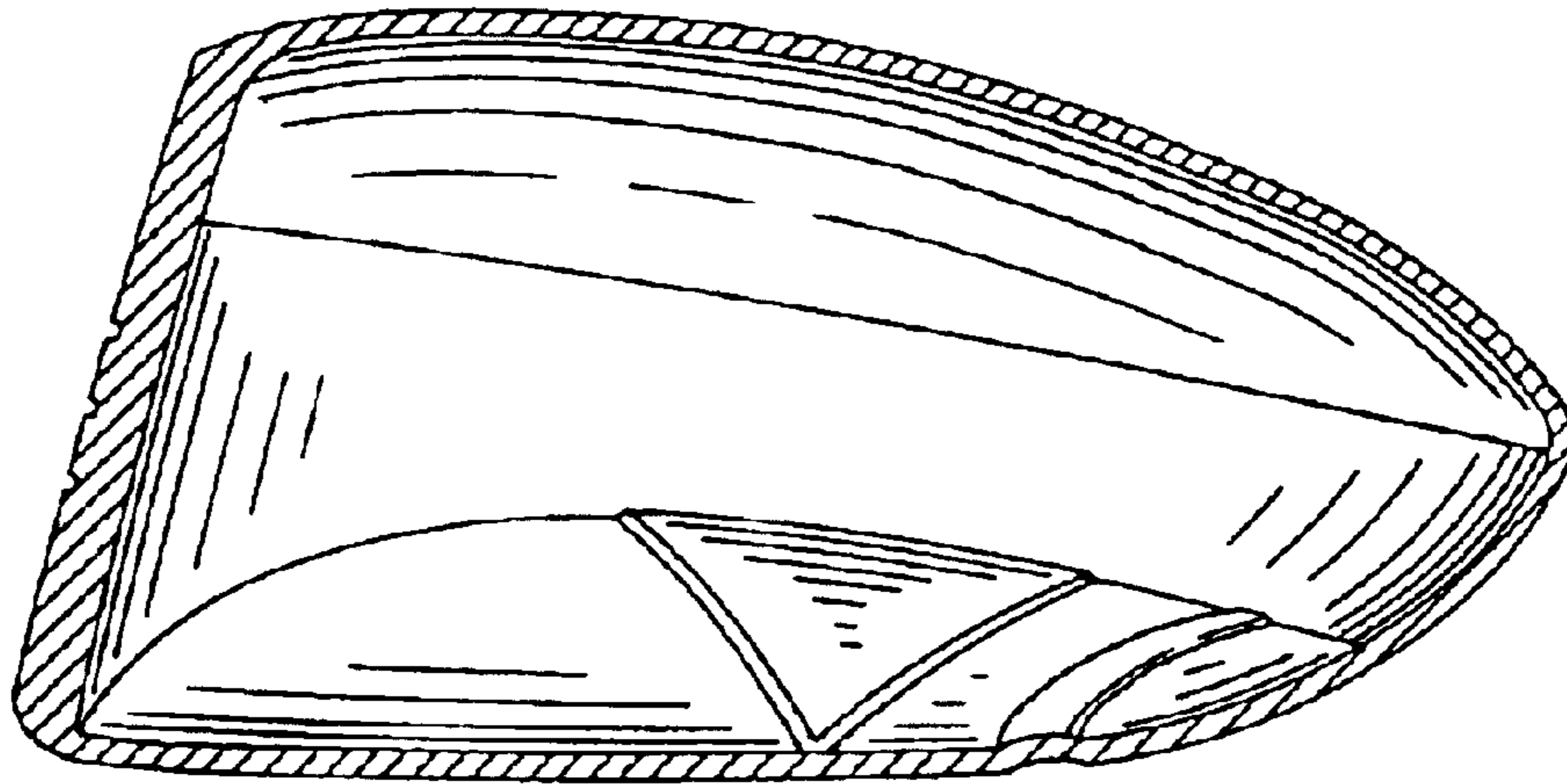

FIG. 30

