

US00D496183S1

(12) **United States Design Patent** (10) **Patent No.:** **US D496,183 S**  
**Savage** (45) **Date of Patent:** **\*\* Sep. 21, 2004**

(54) **DESK MODULE**

(75) Inventor: **Gary Savage**, Montréal (CA)

(73) Assignee: **Savage Designers Inc.**, Montréal (CA)

(\*\*) Term: **14 Years**

(21) Appl. No.: **29/187,670**

(22) Filed: **Aug. 6, 2003**

(30) **Foreign Application Priority Data**

Jun. 25, 2003 (CA) ..... 103527

(51) **LOC (7) Cl.** ..... **06-04**

(52) **U.S. Cl.** ..... **D6/422**

(58) **Field of Search** ..... D6/422-428, 477,  
D6/484; 108/50.01, 50.02; 312/208.1, 194-196

(56) **References Cited**

**U.S. PATENT DOCUMENTS**

D169,320 S	*	4/1953	Knoll	.....	D6/422
D175,836 S	*	10/1955	Hirsch	.....	D6/422
D186,516 S	*	11/1959	Anderson	.....	D6/422
D240,580 S	*	7/1976	Podell	.....	D6/424
D247,730 S	*	4/1978	Robinson	.....	D6/422
D372,373 S	*	8/1996	Meier et al.	.....	D6/422
D380,624 S	*	7/1997	Mezger	.....	D6/422
D489,200 S	*	5/2004	Antonioni	.....	D6/484

\* cited by examiner

*Primary Examiner*—Janice E. Seeger

(74) *Attorney, Agent, or Firm*—Jean H. Dubuc

(57) **CLAIM**

The ornamental design for a desk module, as shown and described.

**DESCRIPTION**

FIG. 1 is a perspective view of a first embodiment of a desk module showing my new design;  
 FIG. 2 is a front view thereof;  
 FIG. 3 is a side elevation thereof;  
 FIG. 4 is an opposite side elevation thereof;  
 FIG. 5 is a top view thereof;  
 FIG. 6 is a rear view thereof;  
 FIG. 7 is a perspective view of a second embodiment of the desk module;  
 FIG. 8 is a front view thereof;  
 FIG. 9 is a side elevation thereof;  
 FIG. 10 is an opposite elevation thereof;  
 FIG. 11 is a top view thereof;  
 FIG. 12 is a rear view thereof.  
 FIG. 13 is a perspective view of a third embodiment of the desk module;  
 FIG. 14 is a front view thereof;  
 FIG. 15 is a side elevation thereof;  
 FIG. 16 is an opposite elevation thereof;  
 FIG. 17 is a top view thereof; and,  
 FIG. 18 is a rear view thereof.

**1 Claim, 9 Drawing Sheets**

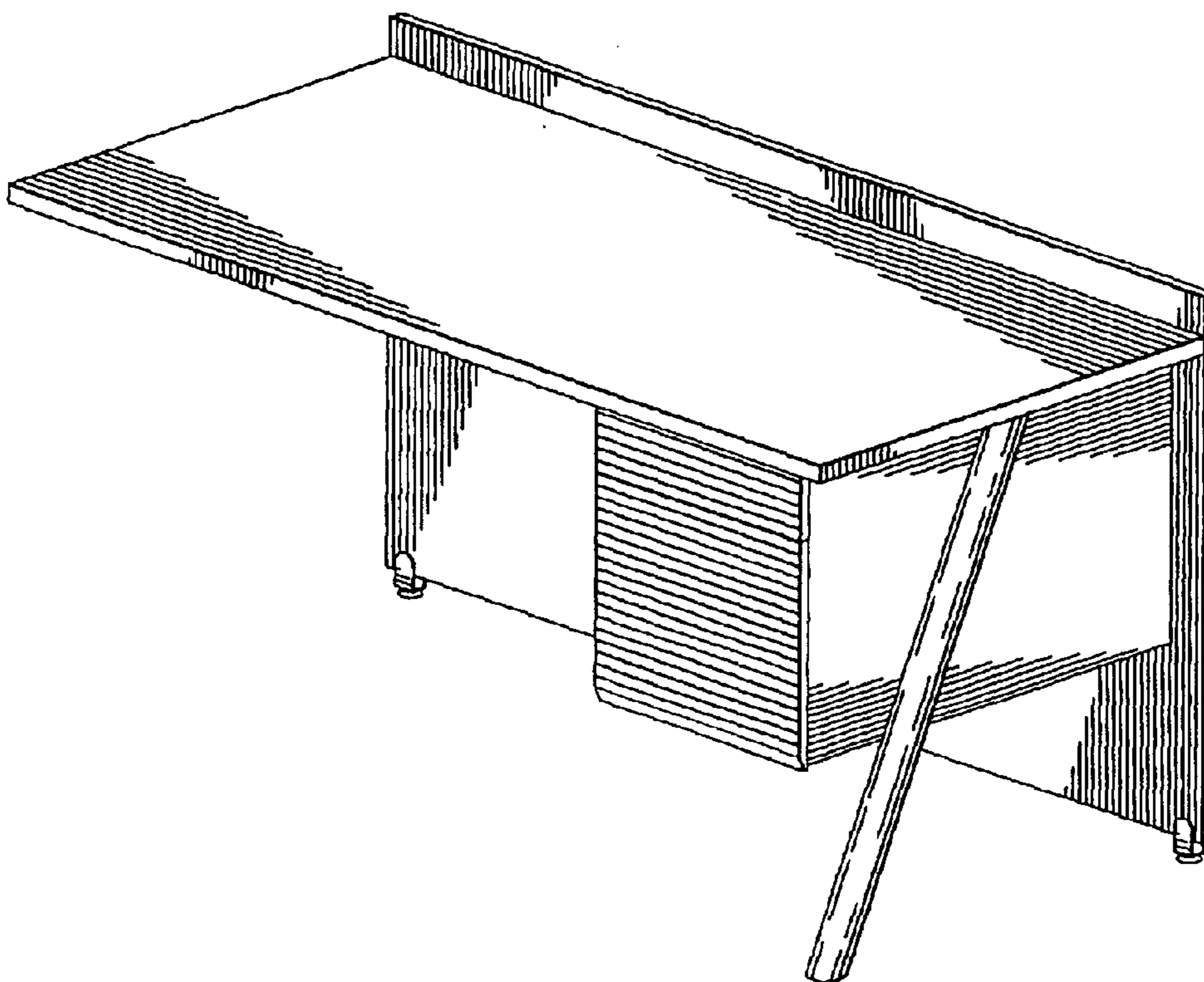

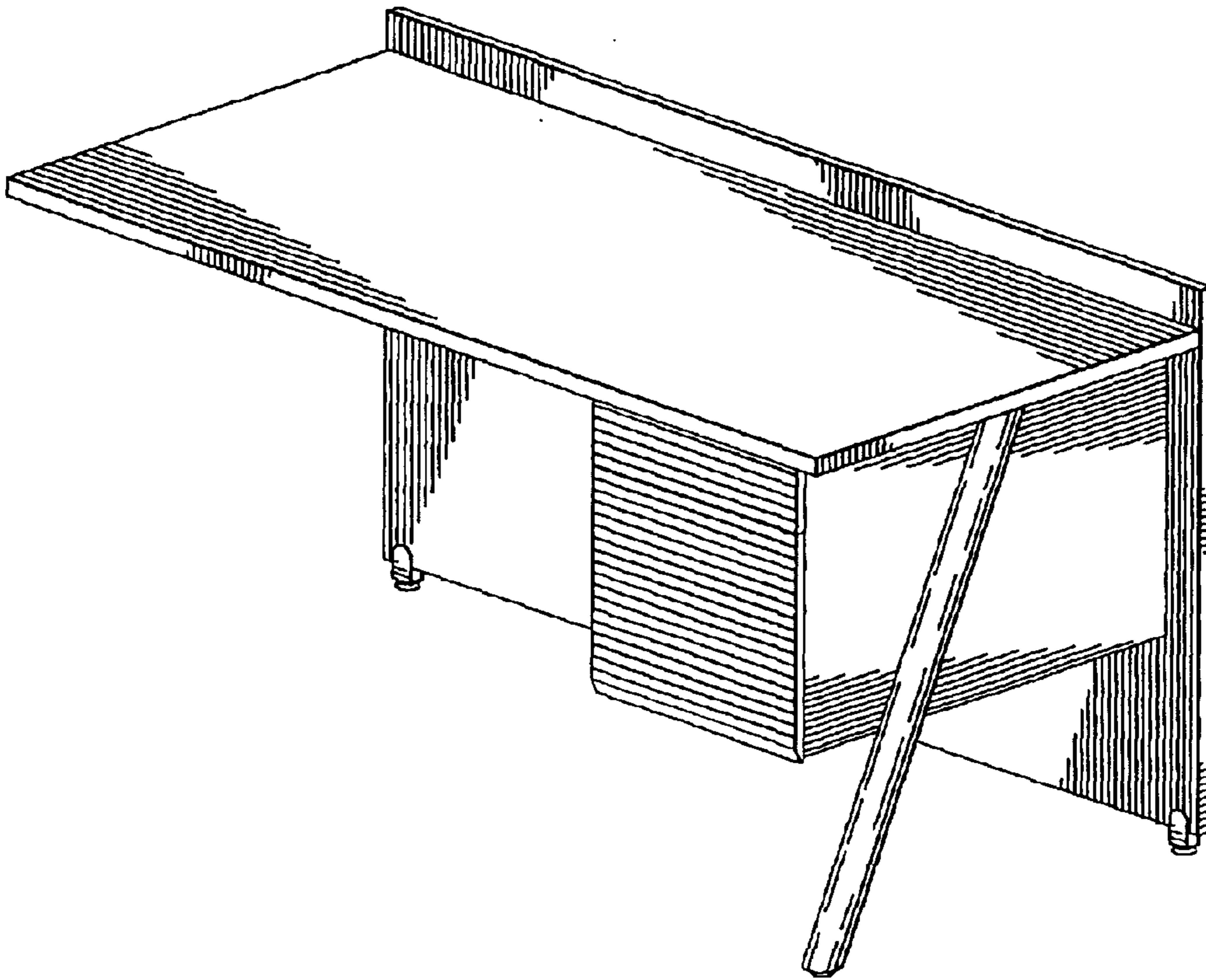

FIG. 1

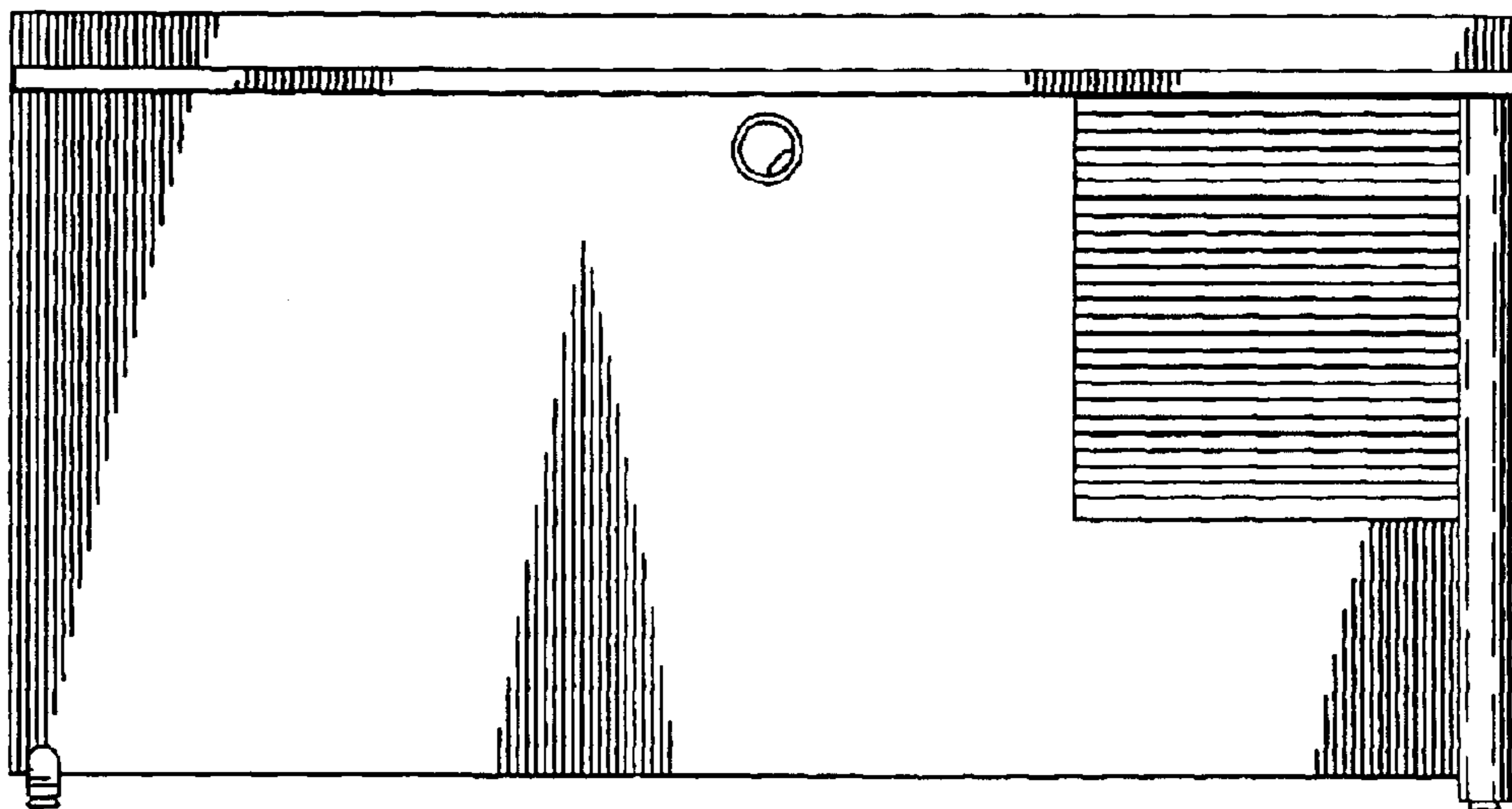

FIG. 2

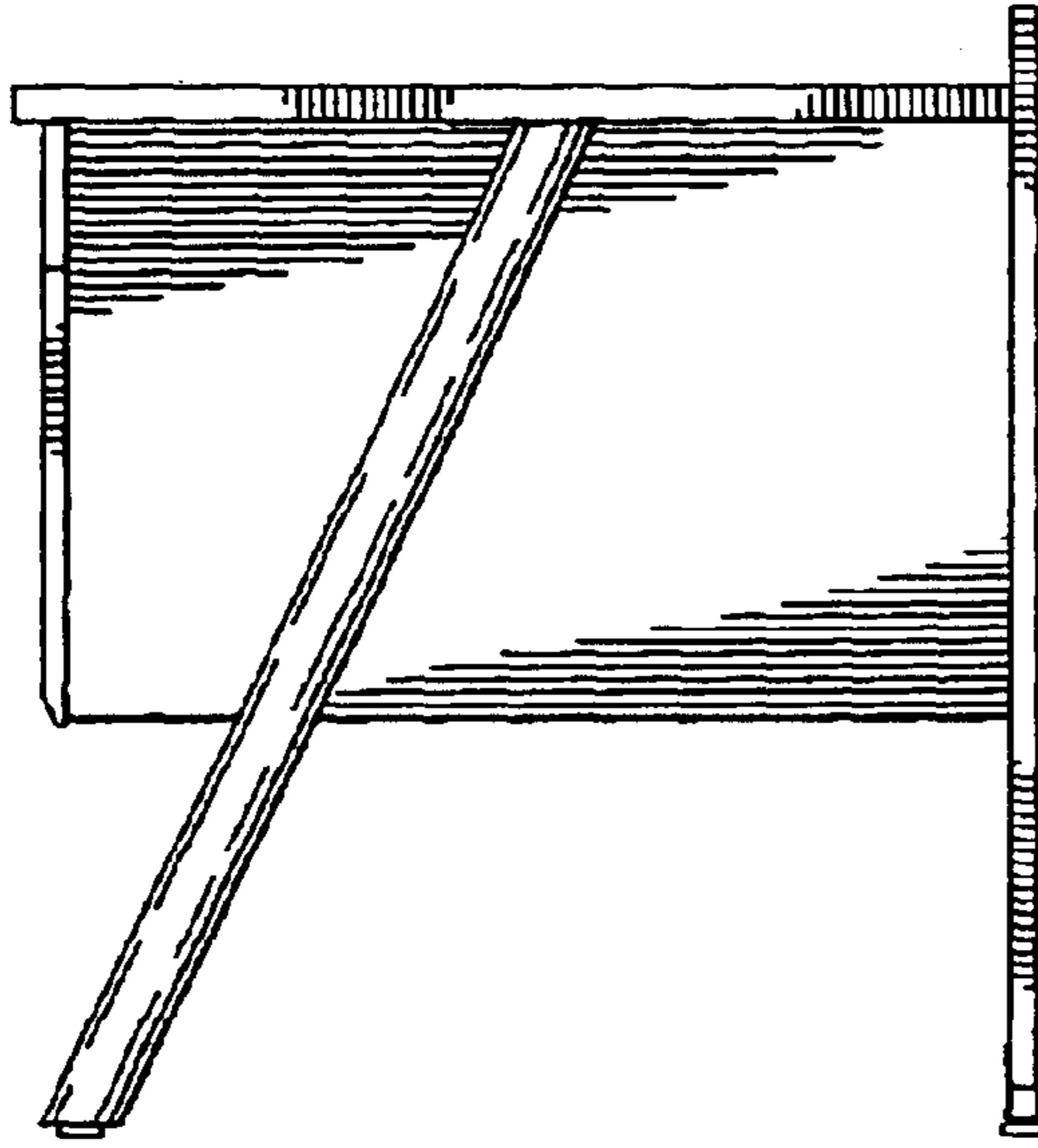

FIG. 3

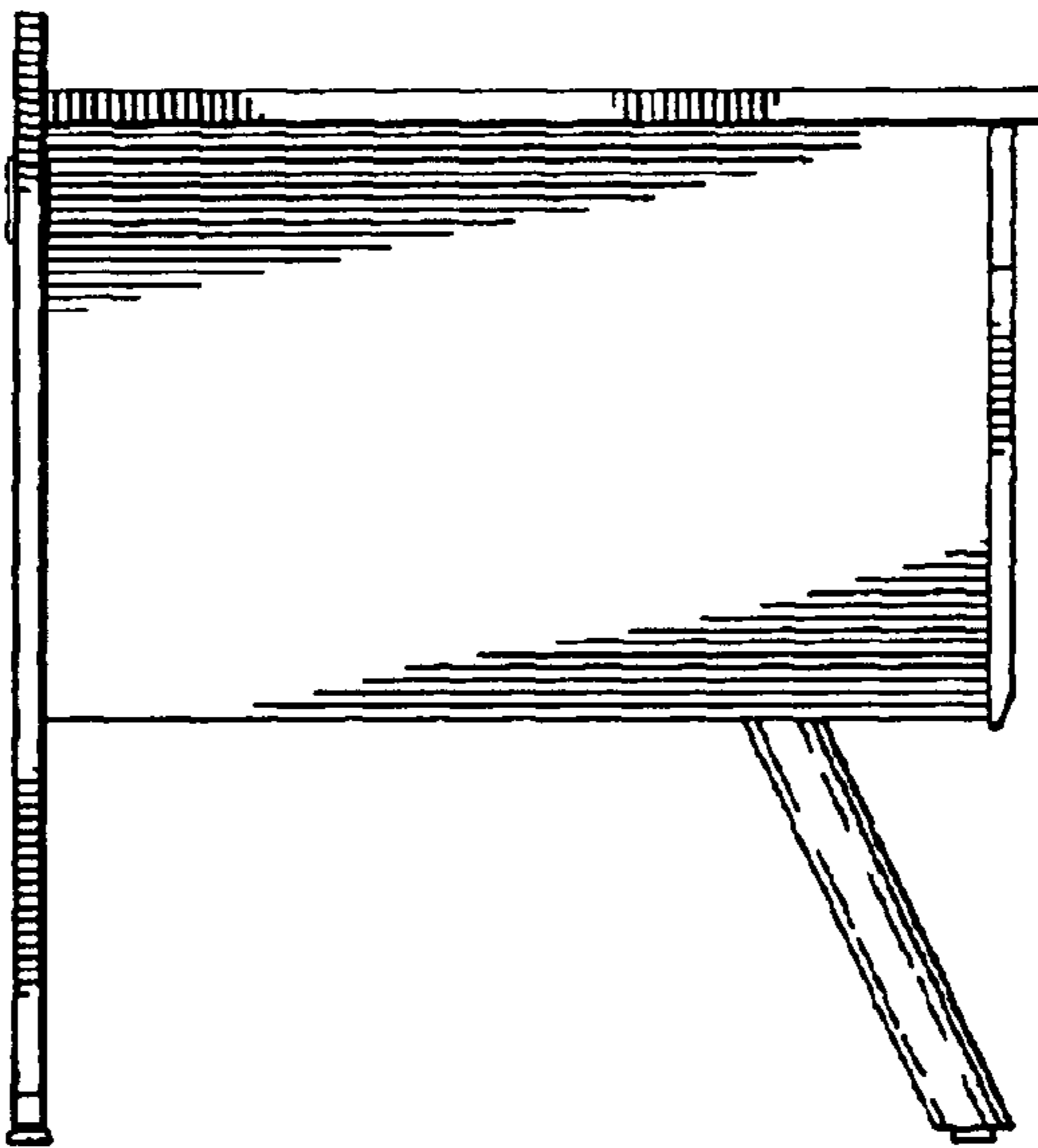

FIG. 4

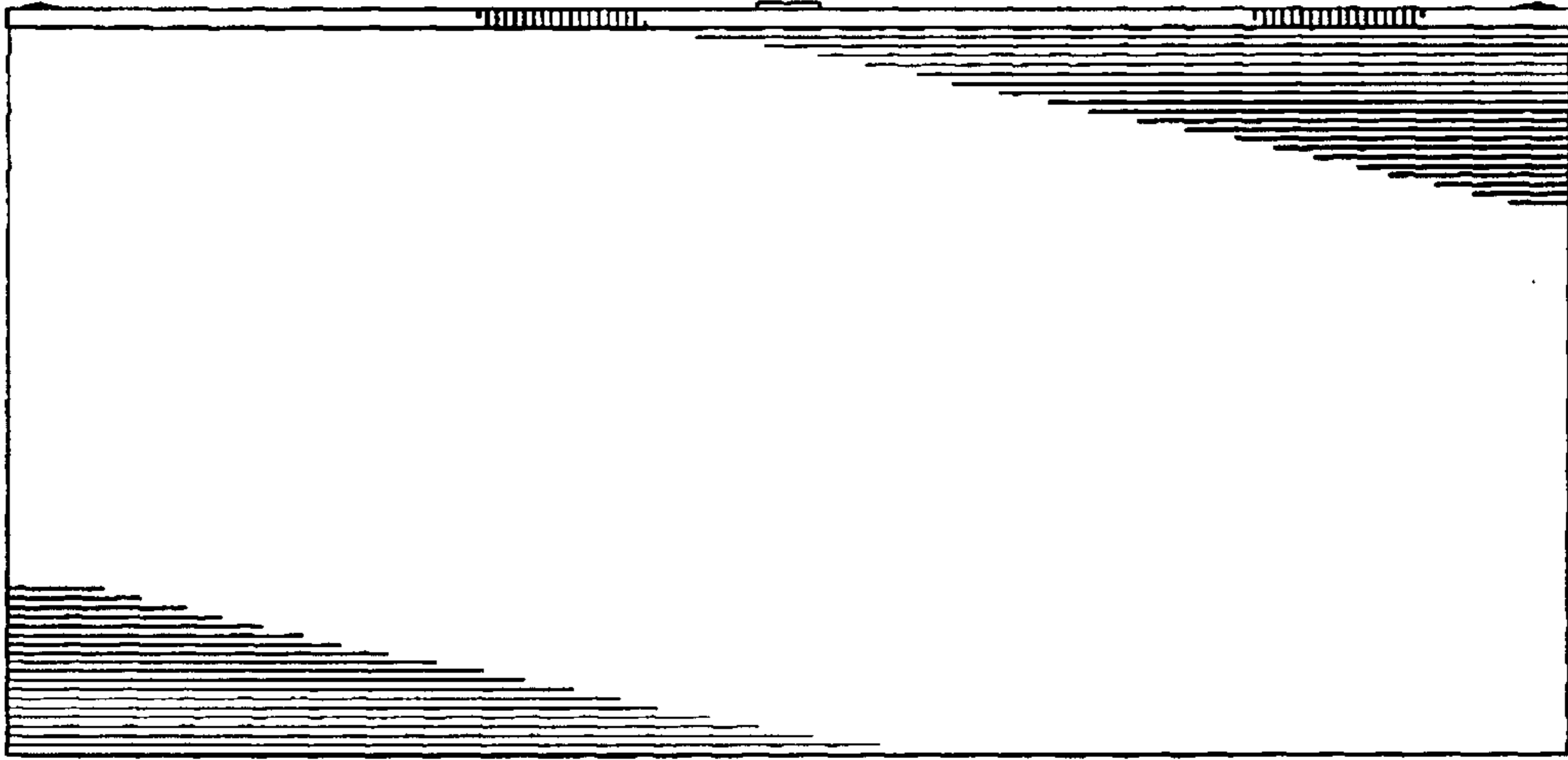

FIG. 5

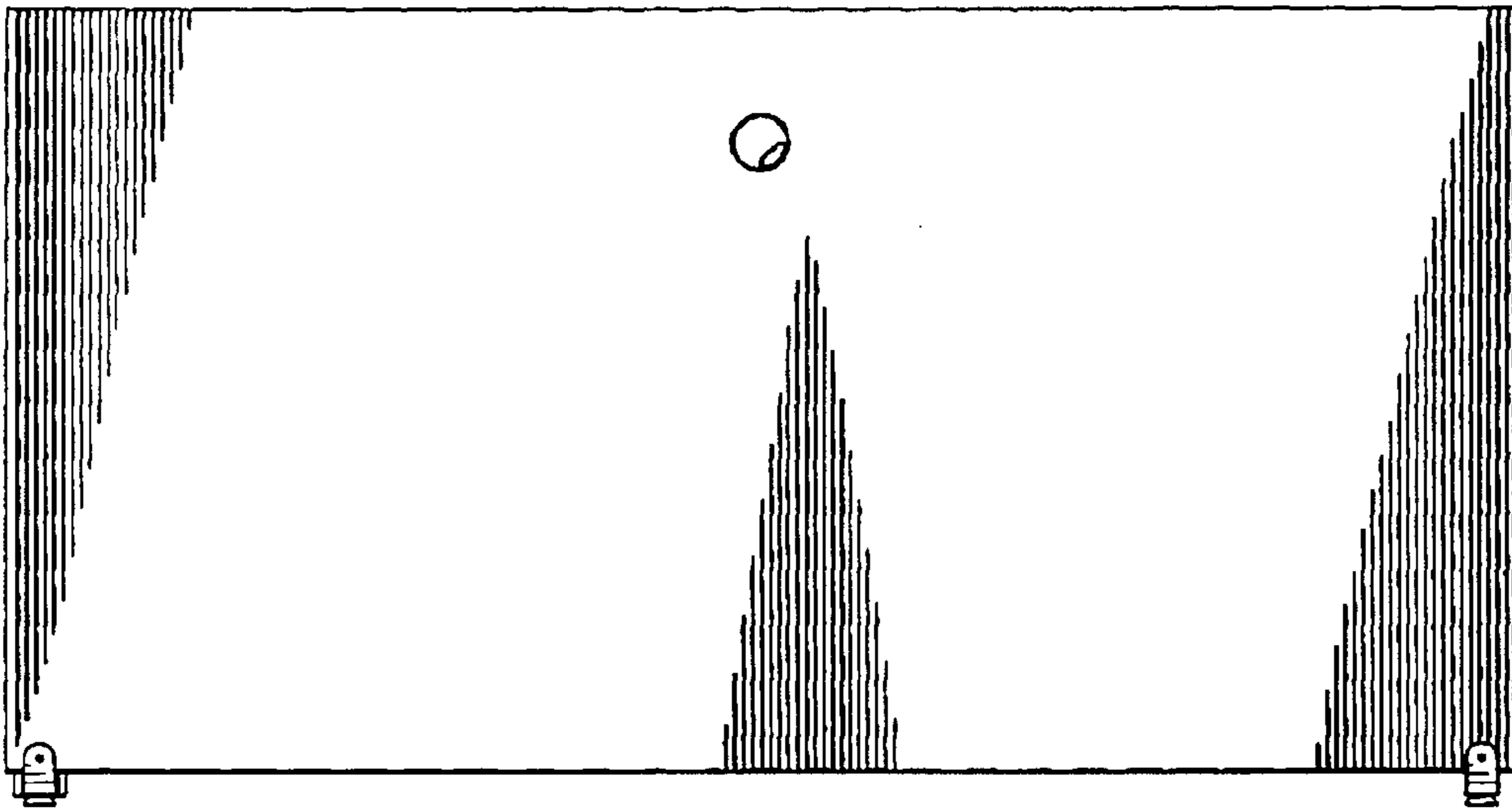

FIG. 6

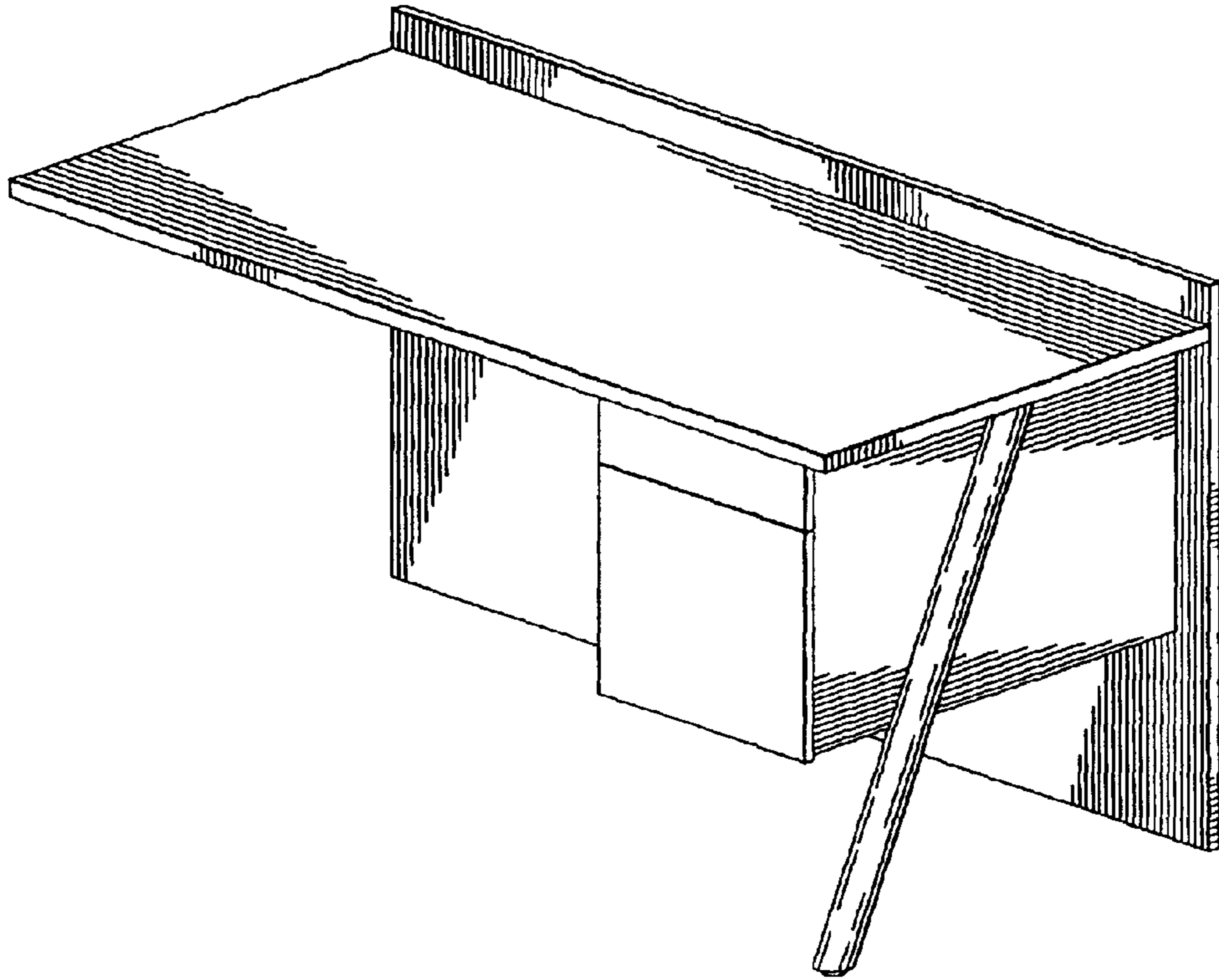

FIG. 7

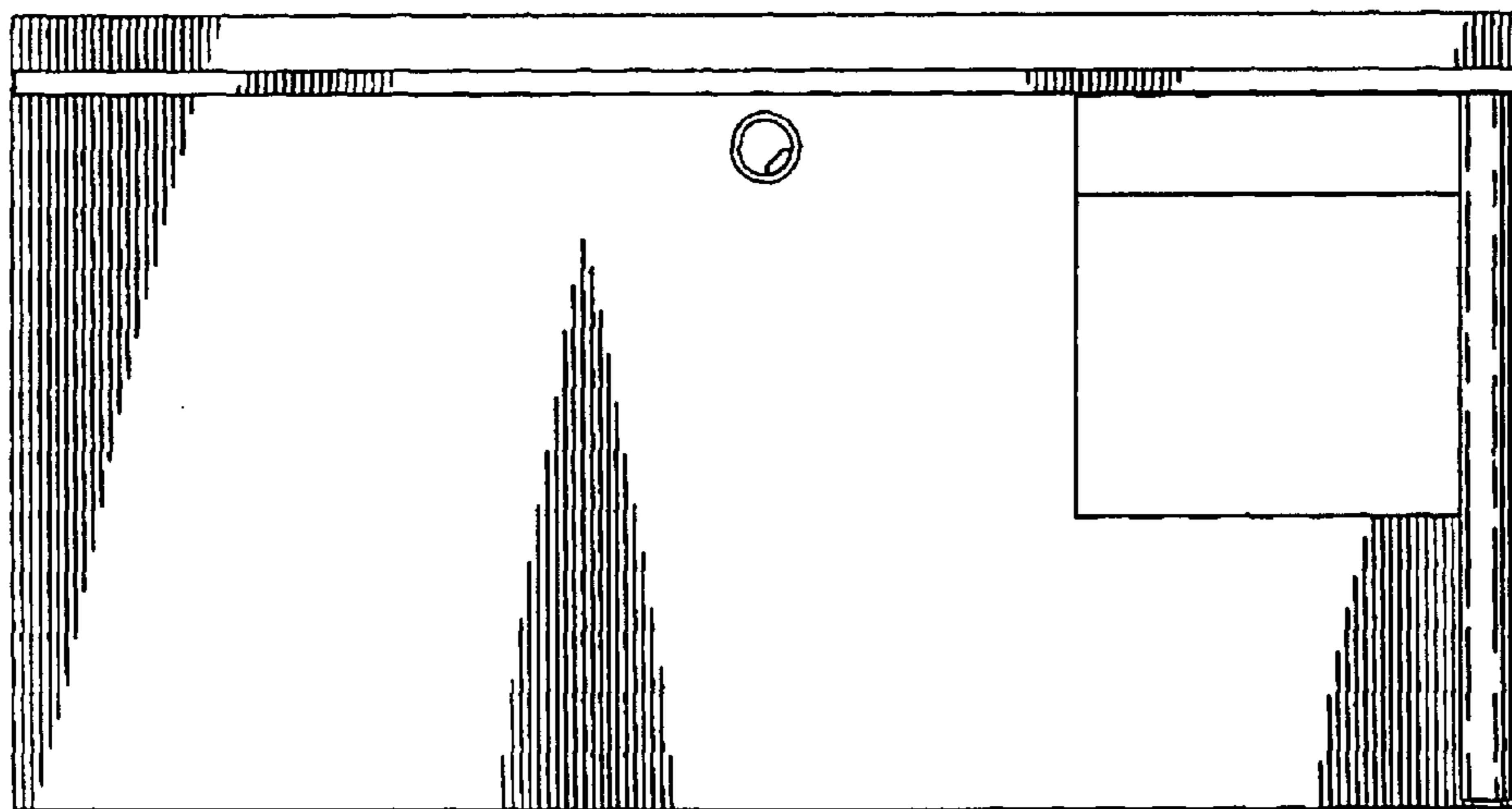

FIG. 8

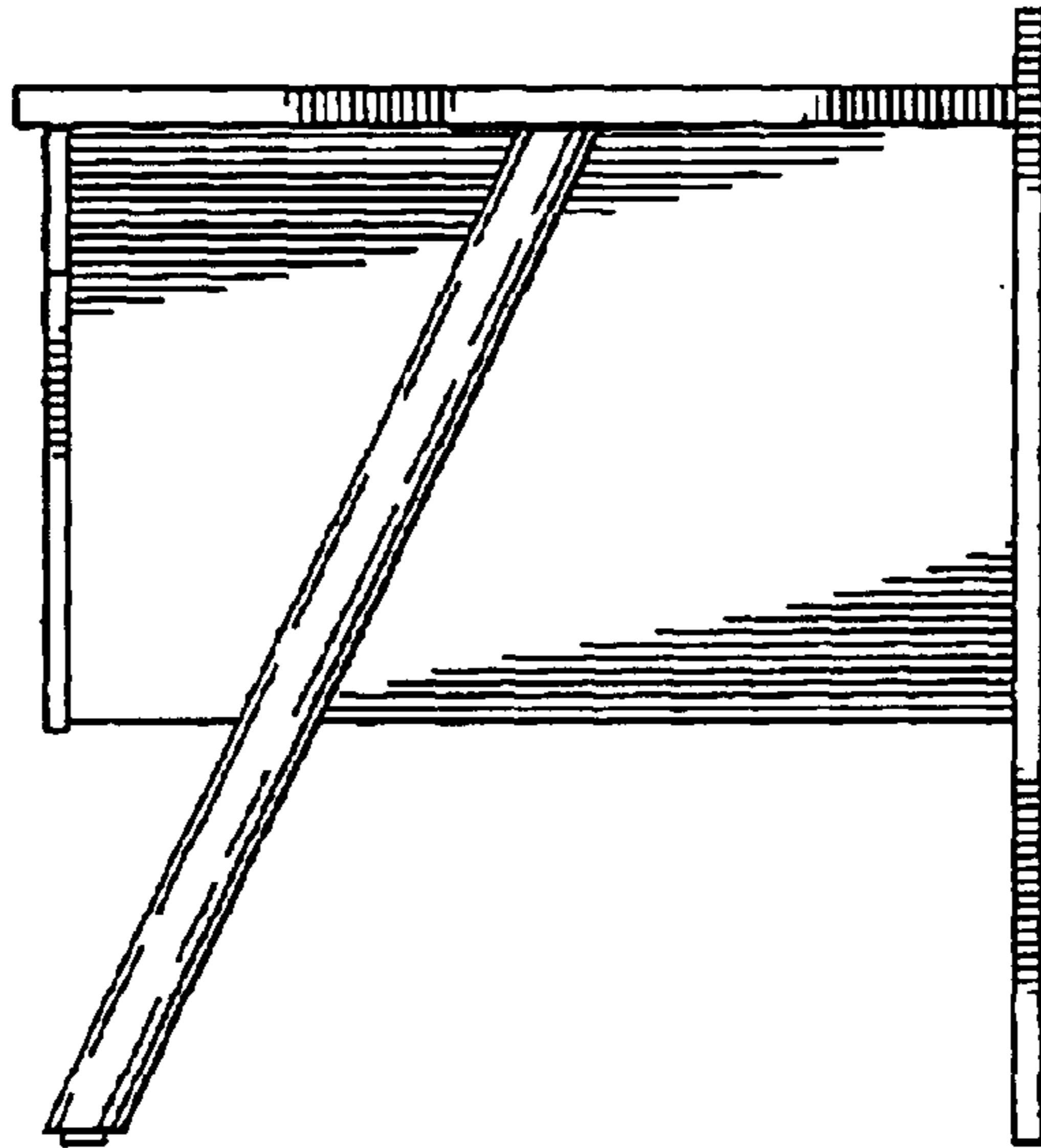

FIG. 9

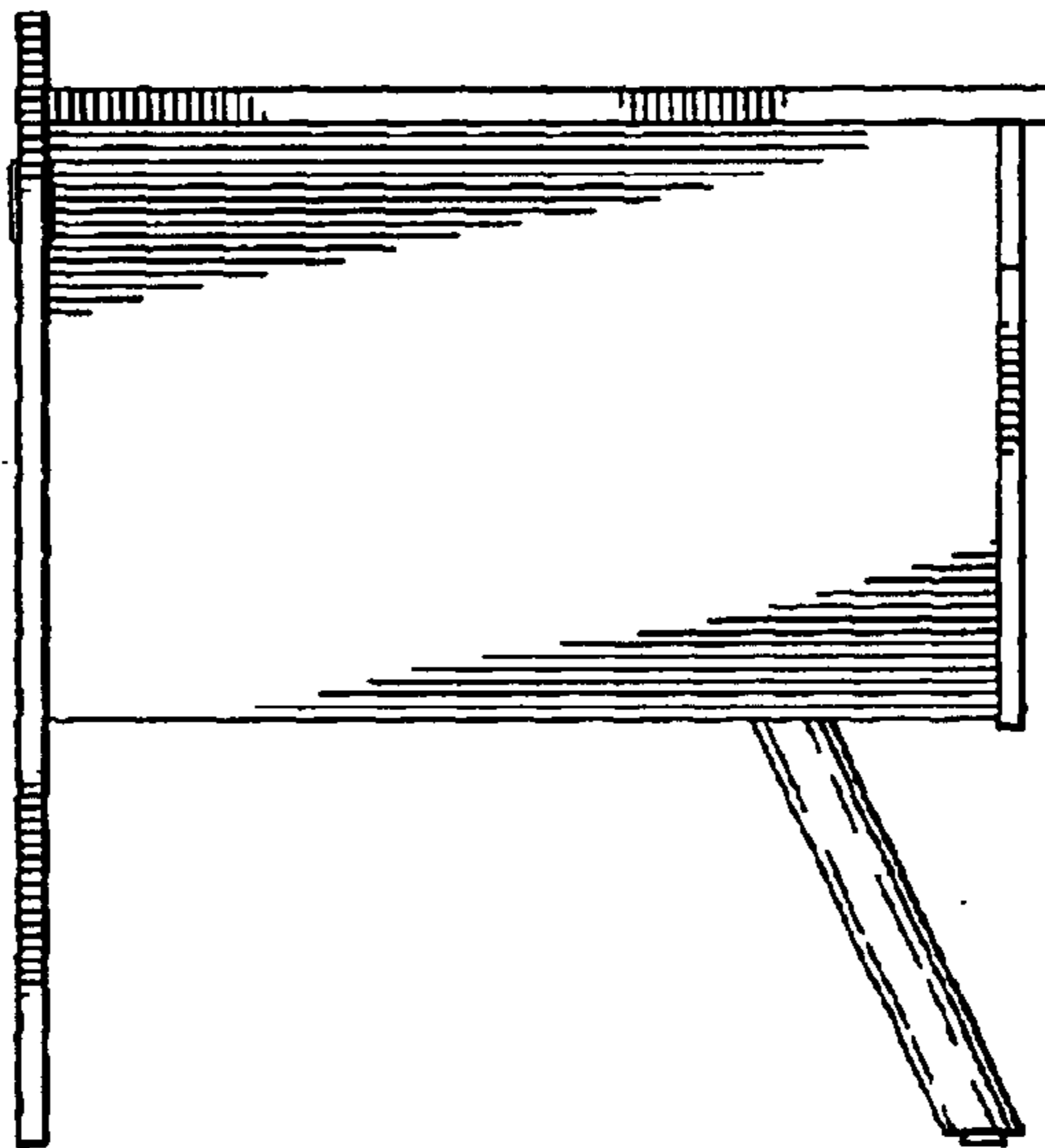

FIG. 10

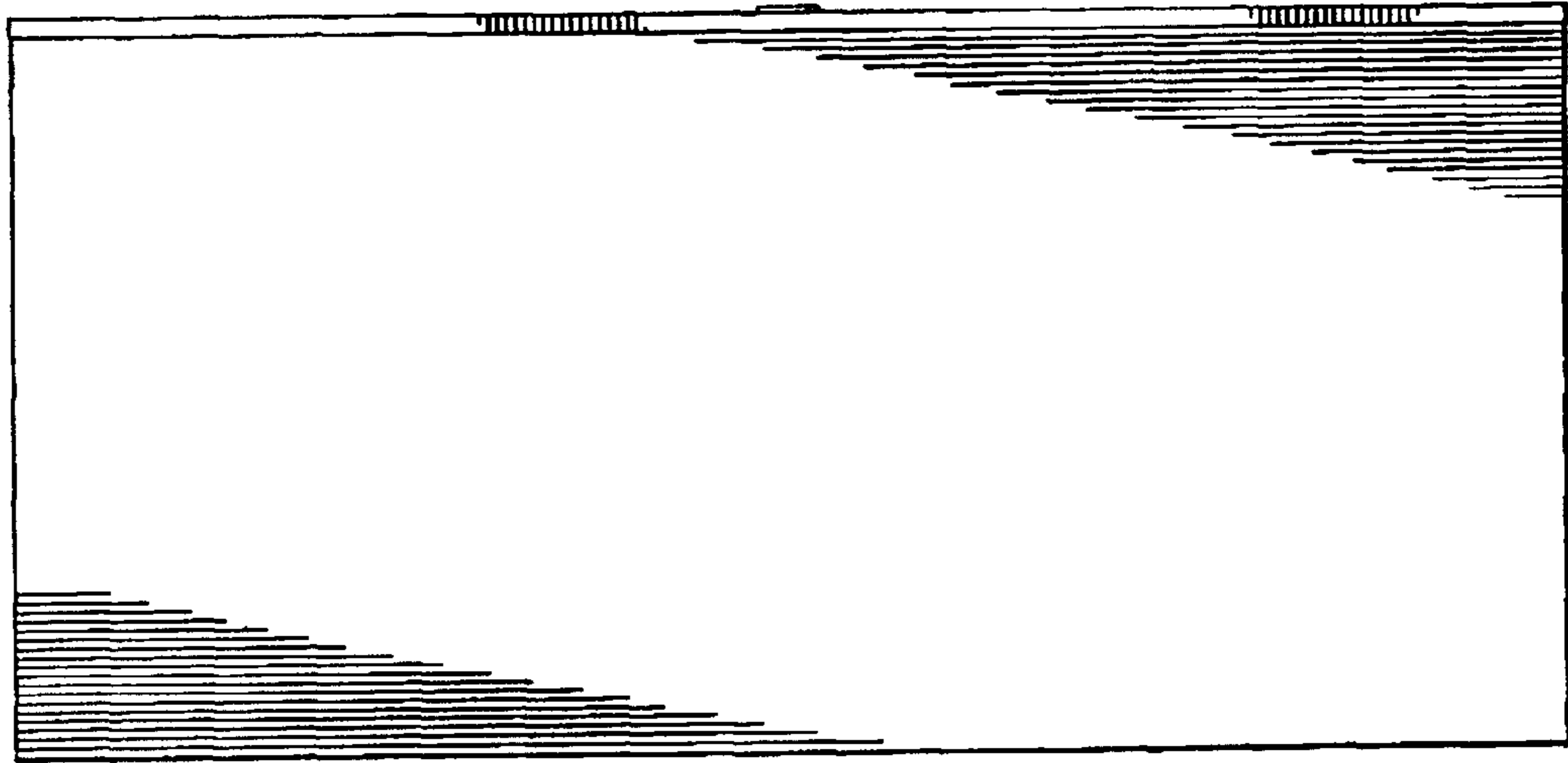

FIG. 11

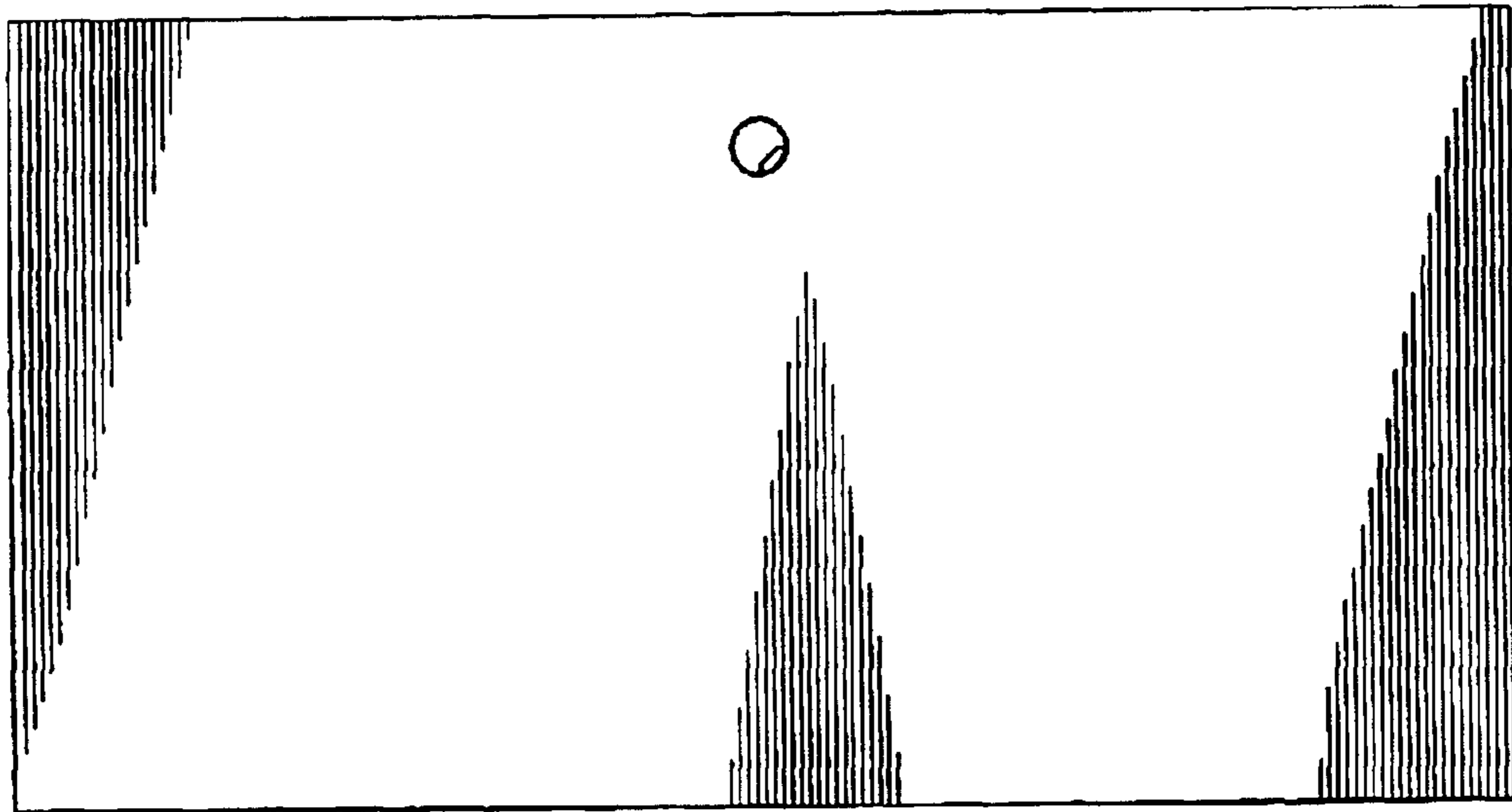

FIG. 12

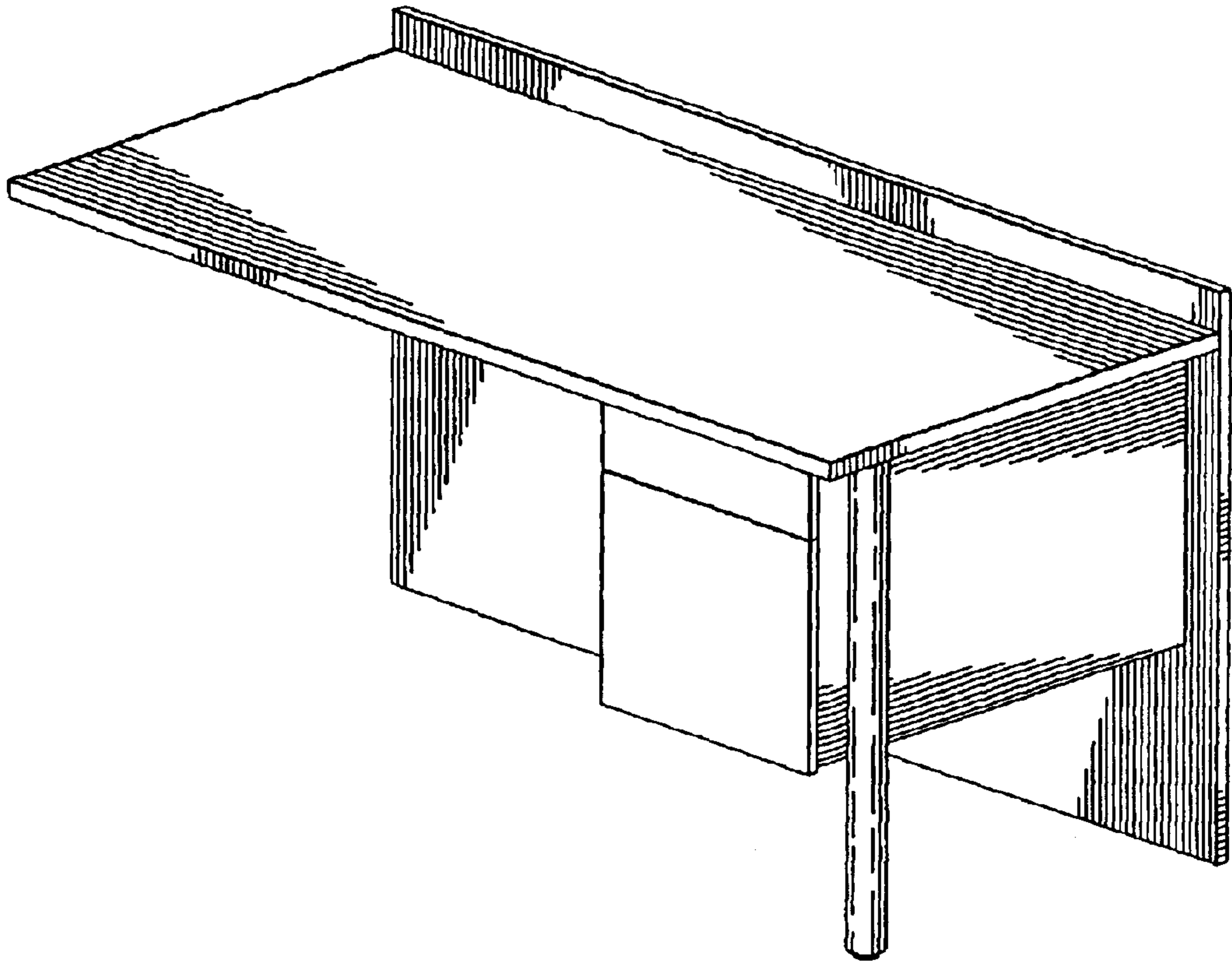

FIG. 13

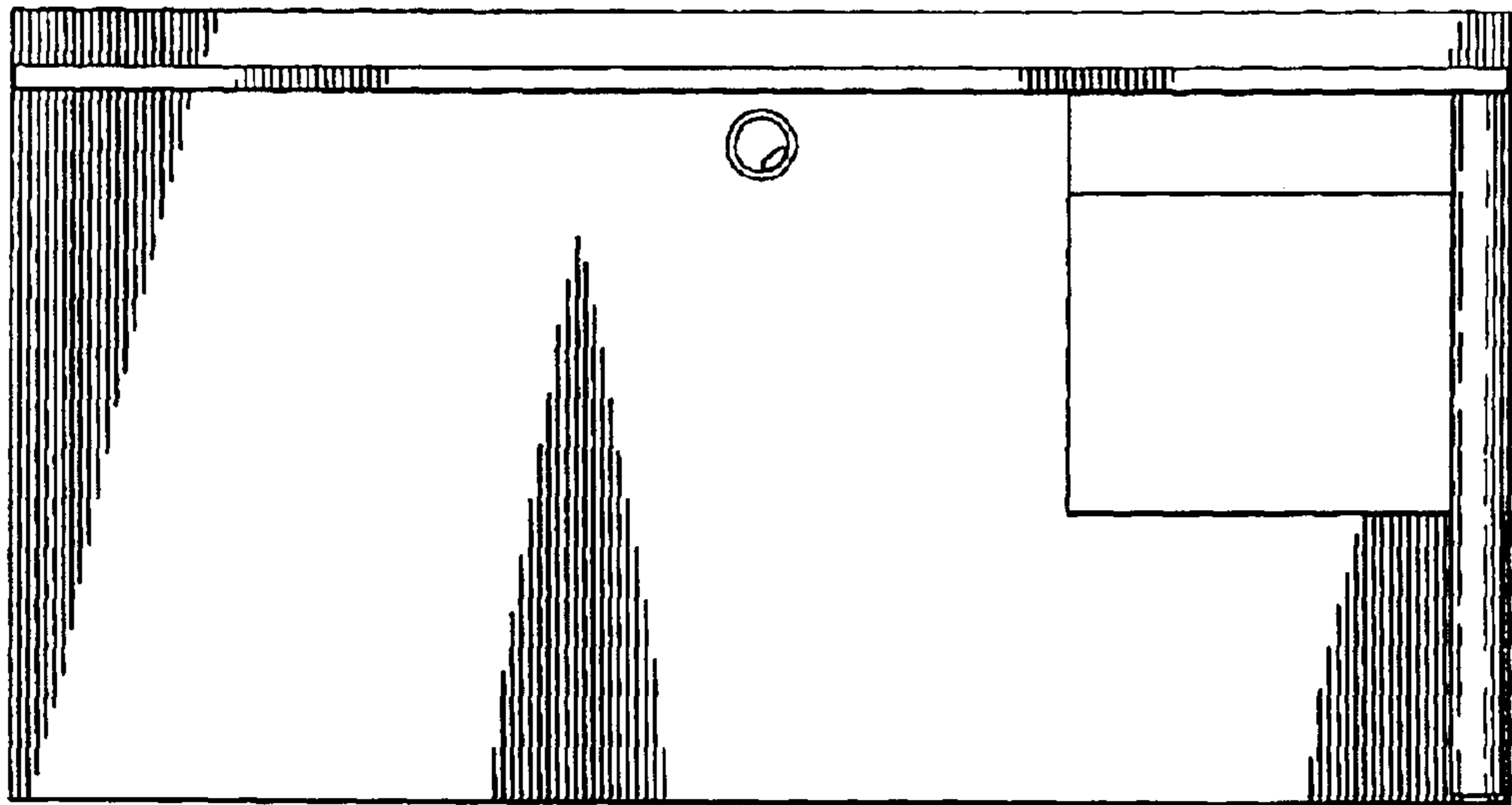

FIG. 14



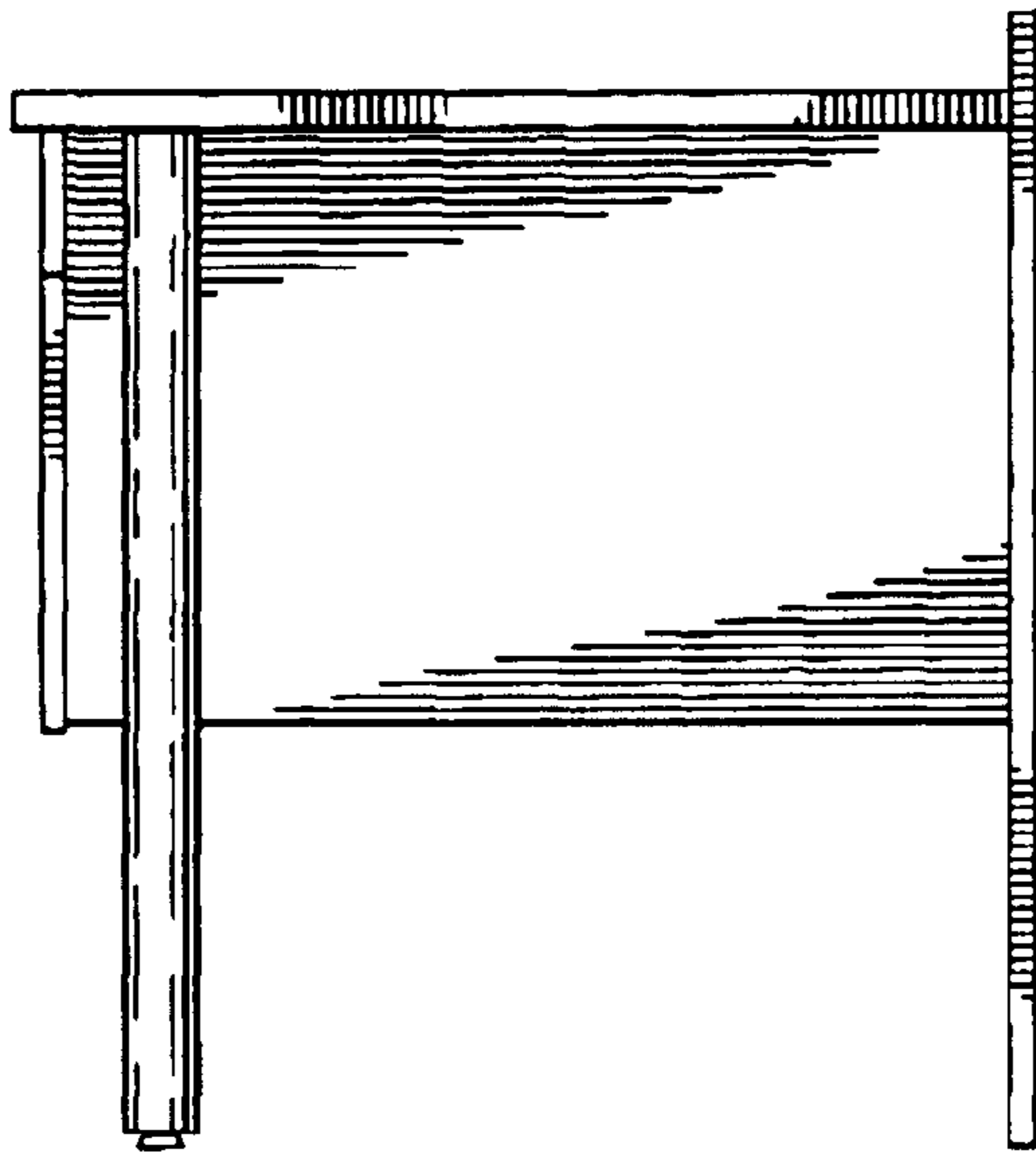

FIG. 15

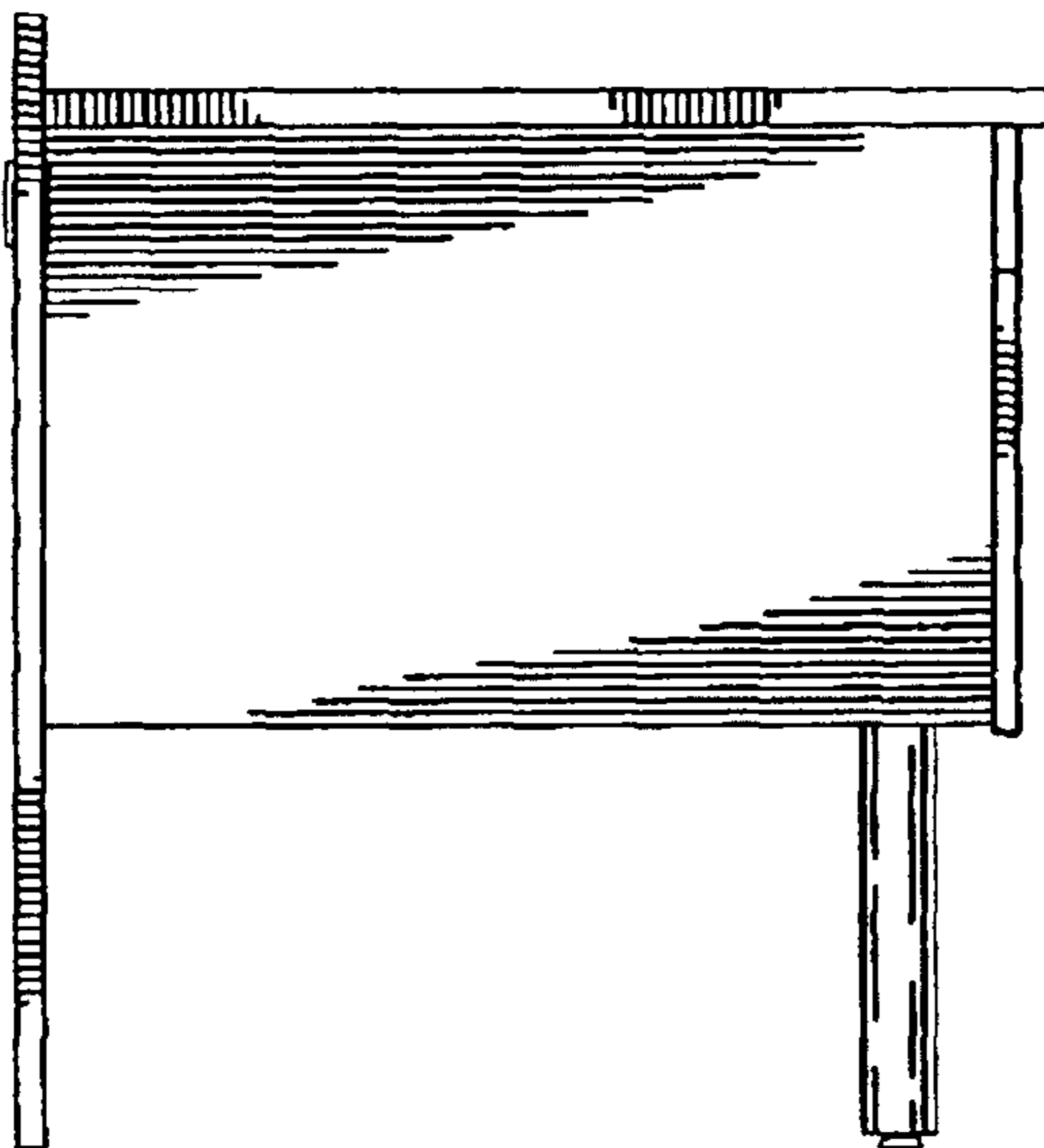

FIG. 16

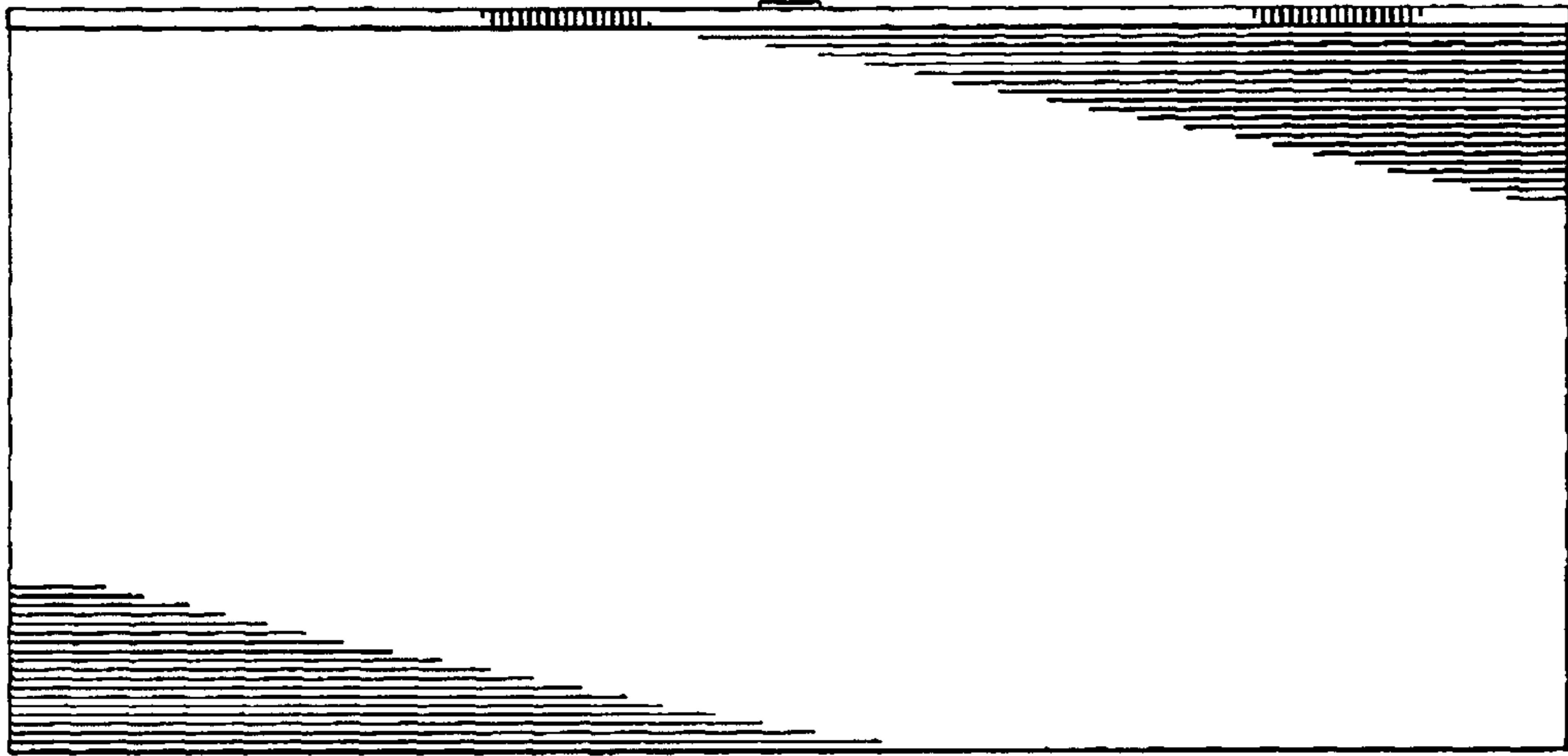

FIG. 17

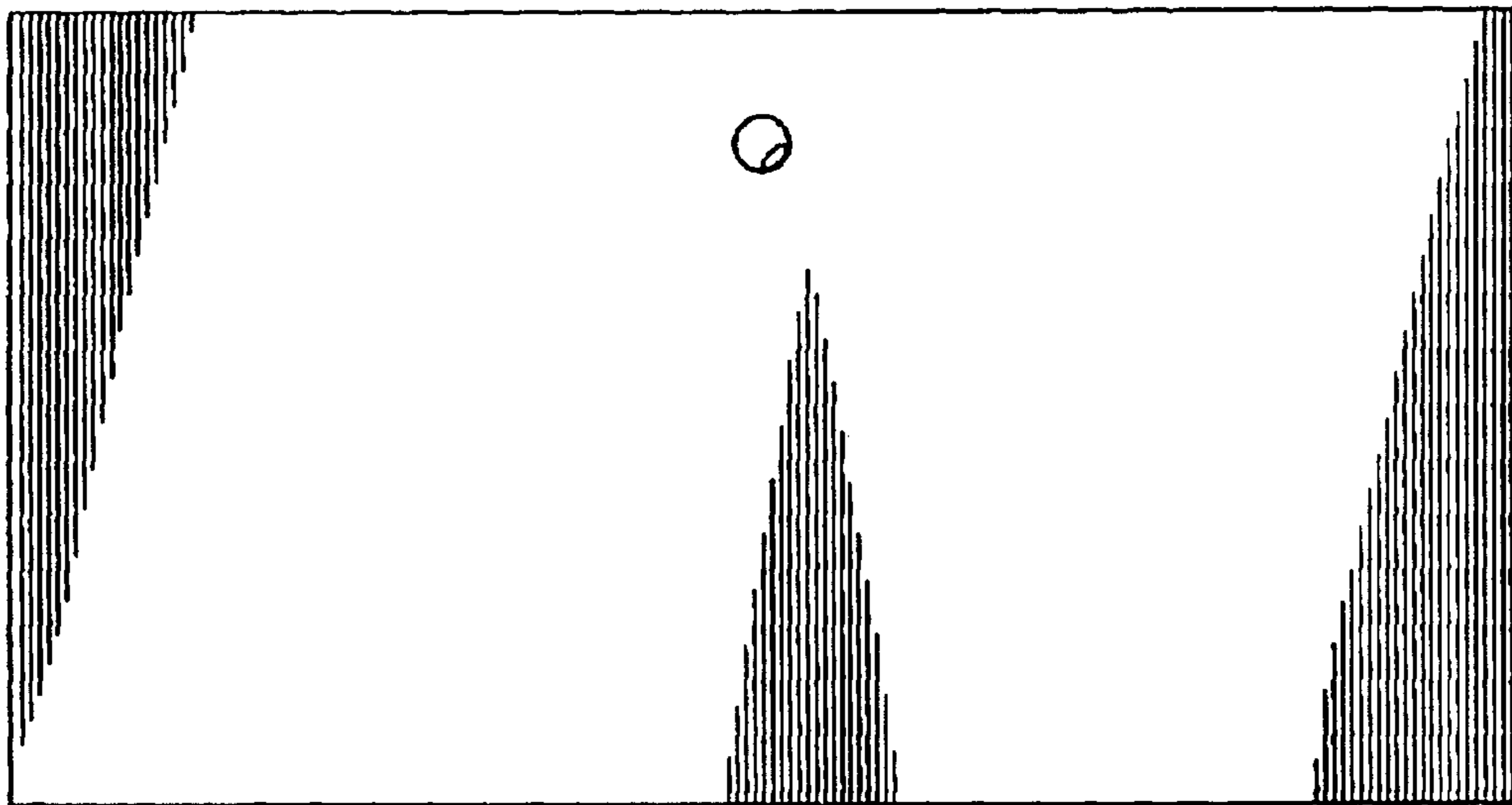

FIG. 18