

US00D496171S1

(12) **United States Design Patent**
Su

(10) **Patent No.:** **US D496,171 S**

(45) **Date of Patent:** **** Sep. 21, 2004**

(54) **CHAIR**

D472,065 S * 3/2003 Tseng D6/366
D481,879 S * 11/2003 Su D6/366

(76) Inventor: **Tung-Hua Su**, No. 6, Sec. 3, Bao Ta Road, Kuwi Jen Hsiang, Tainan Hsien (TW)

* cited by examiner

(**) Term: **14 Years**

Primary Examiner—Gary D. Watson
(74) *Attorney, Agent, or Firm*—Charles E. Baxley

(21) Appl. No.: **29/185,529**

(57) **CLAIM**

(22) Filed: **Jun. 27, 2003**

The ornamental design for a chair, as shown.

(51) **LOC (7) Cl.** **06-01**

DESCRIPTION

(52) **U.S. Cl.** **D6/366**

FIG. 1 is a perspective view of a chair showing my new design;

(58) **Field of Search** D6/334, 335, 364, D6/365, 366, 367, 500, 501, 502; 297/411.2, 411.27, 411.36

FIG. 2 is a front elevation view thereof;
FIG. 3 is a rear elevation view thereof;
FIG. 4 is a left side elevation view thereof;
FIG. 5 is a right side elevation view thereof;
FIG. 6 is a top plan view thereof; and,
FIG. 7 is a bottom plan view thereof.

(56) **References Cited**

U.S. PATENT DOCUMENTS

D436,260 S * 1/2001 Nagamitsu D6/366
D436,456 S * 1/2001 Neil D6/366
D437,702 S * 2/2001 Koepke et al. D6/366

1 Claim, 6 Drawing Sheets

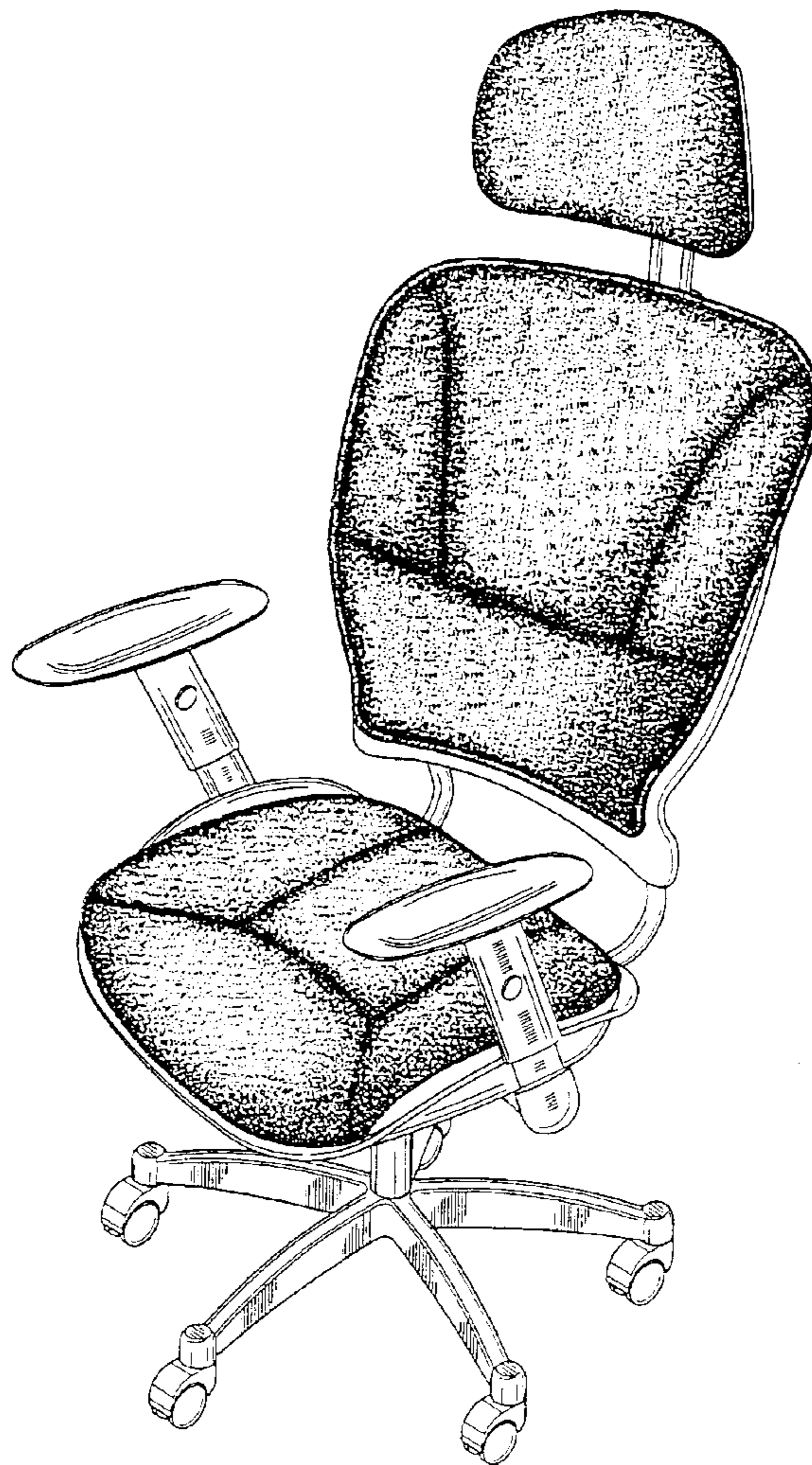

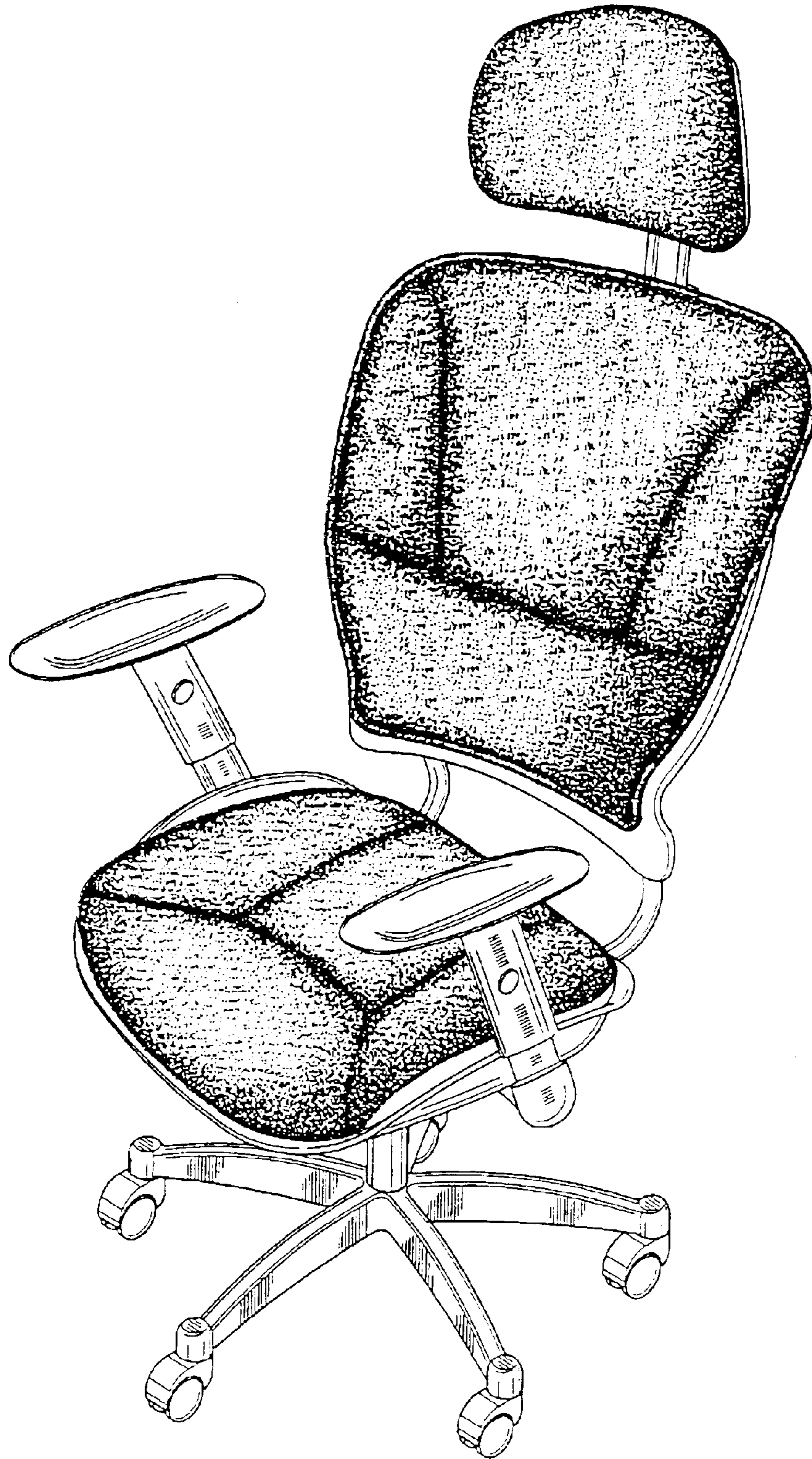

FIG. 1

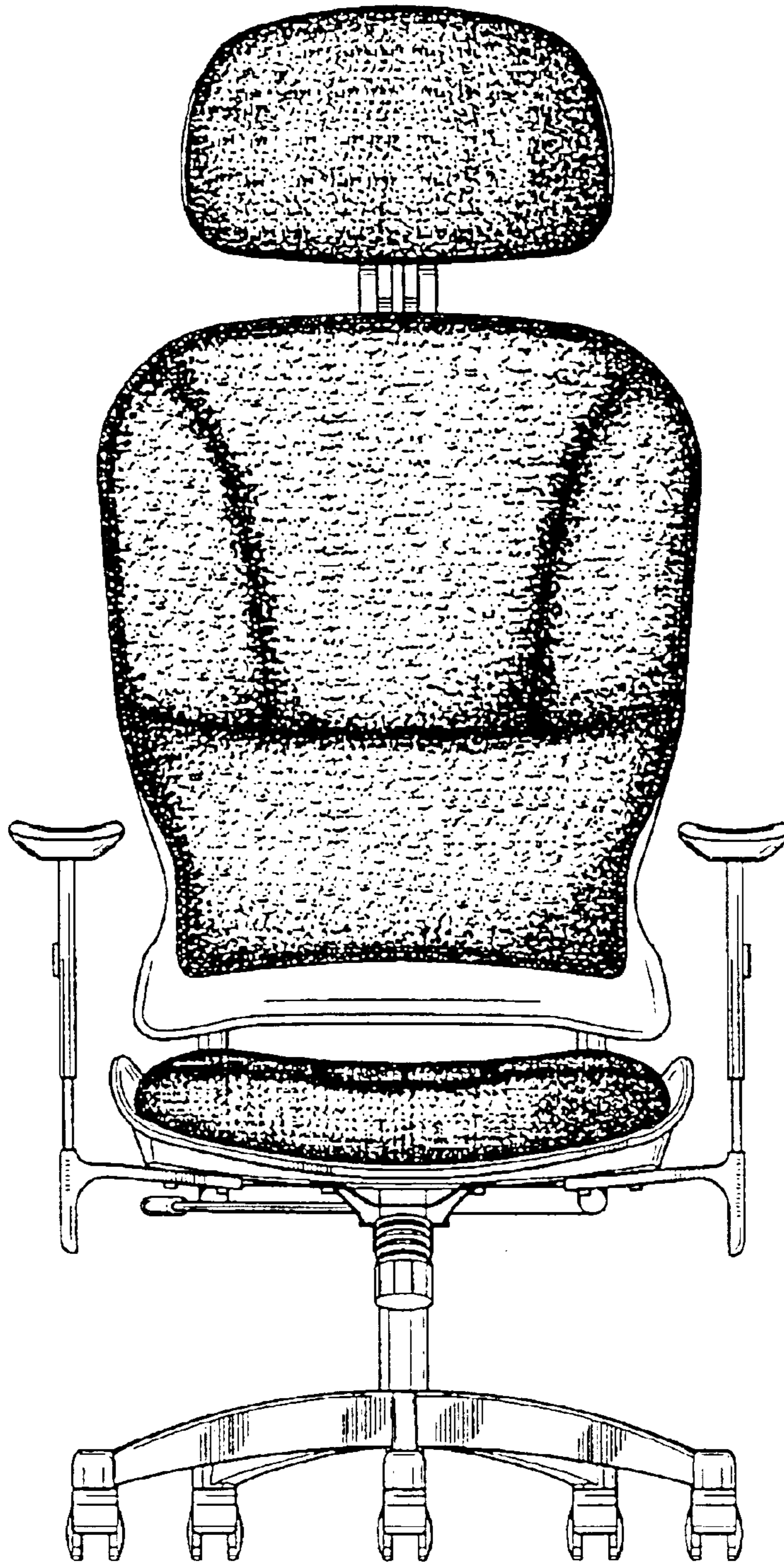

FIG. 2

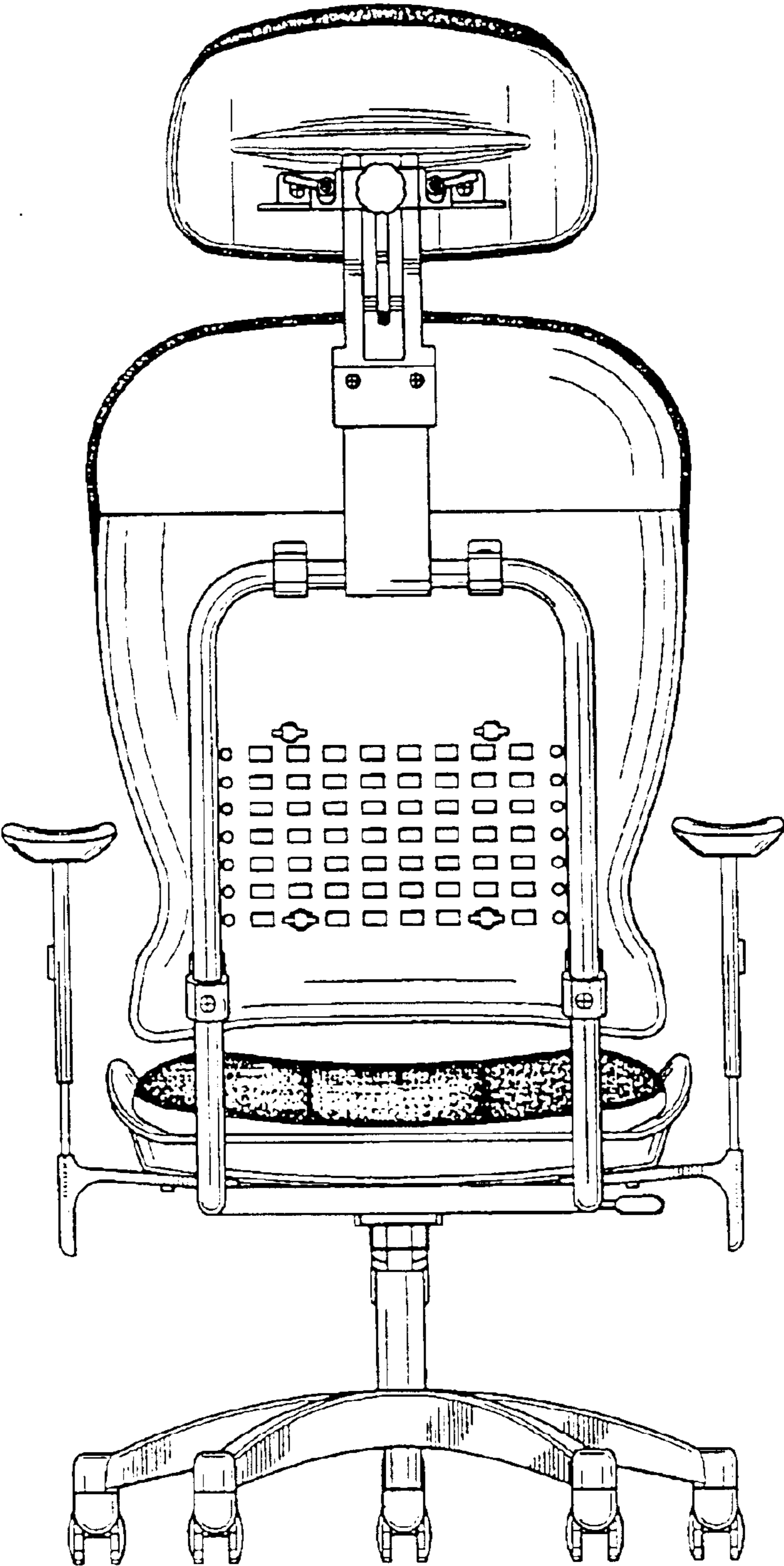

FIG. 3

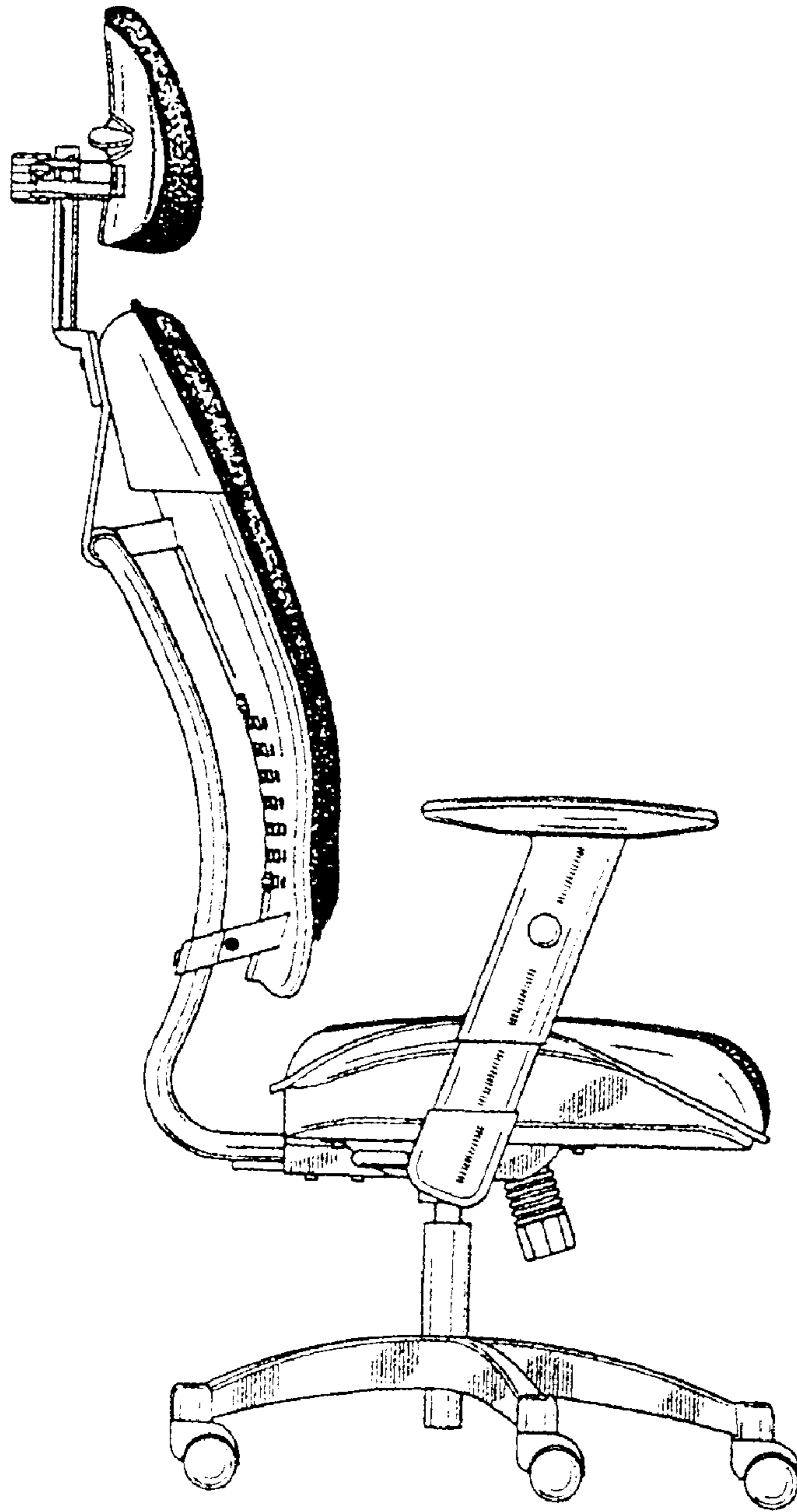

FIG. 4

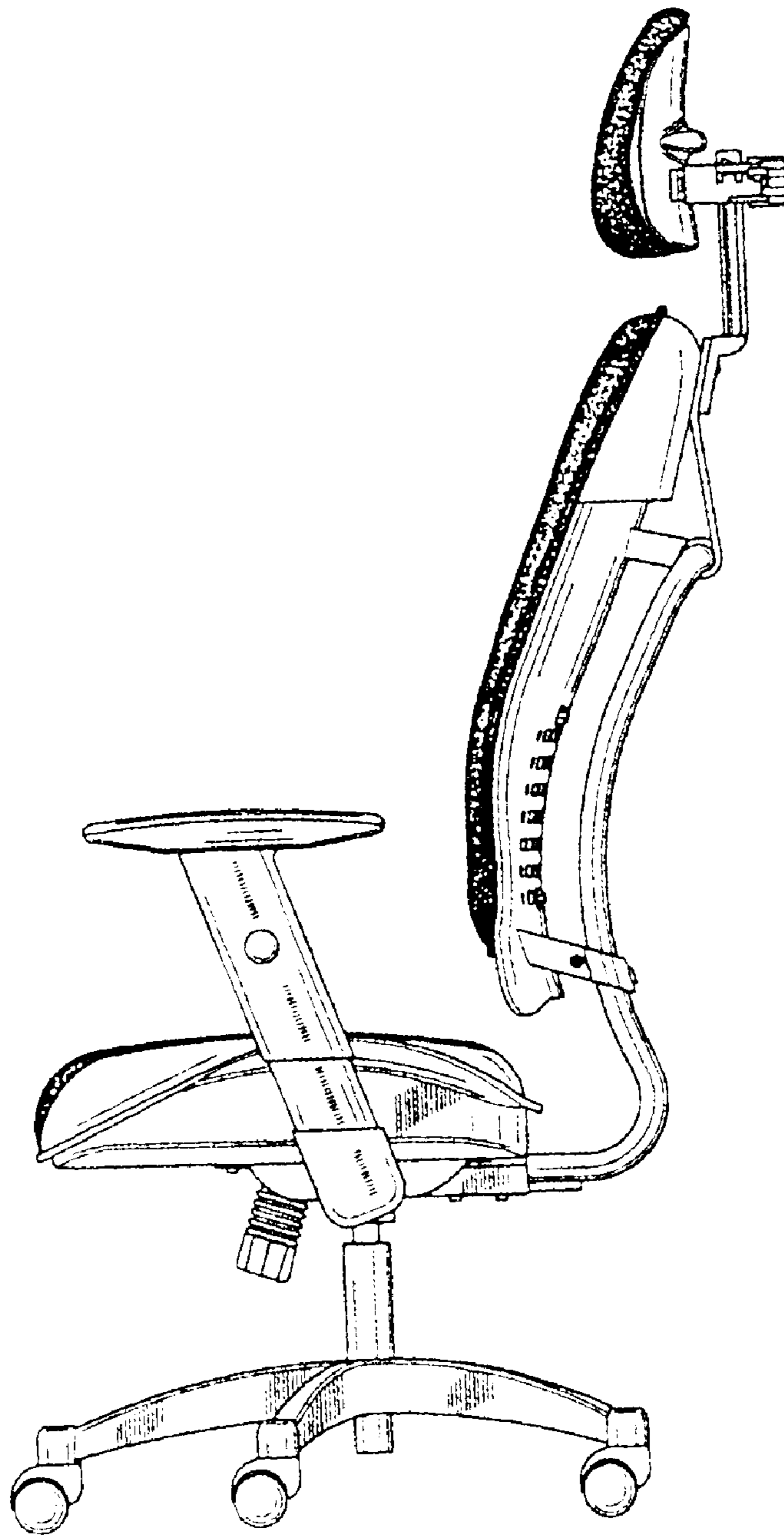

FIG. 5

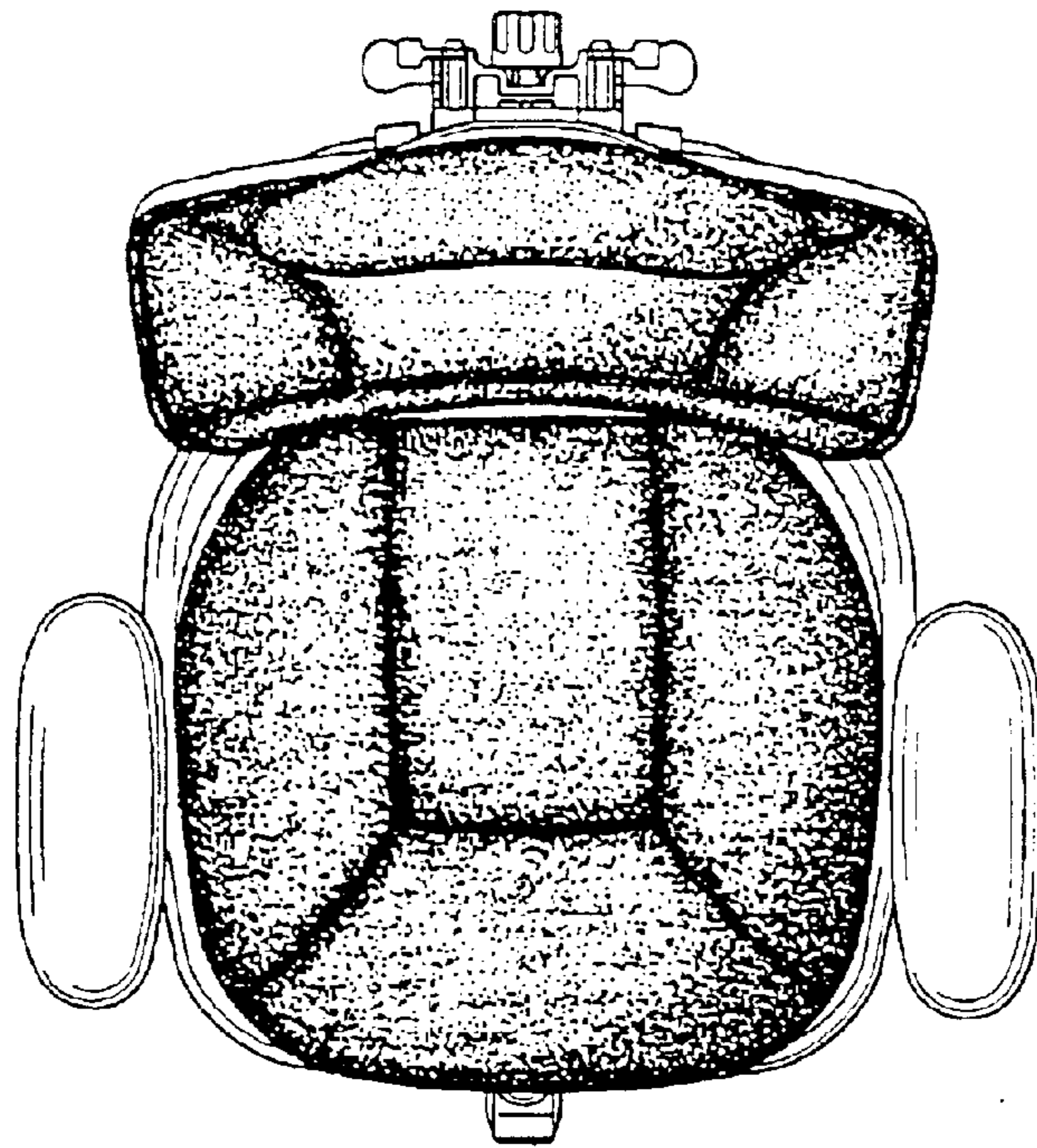

FIG. 6

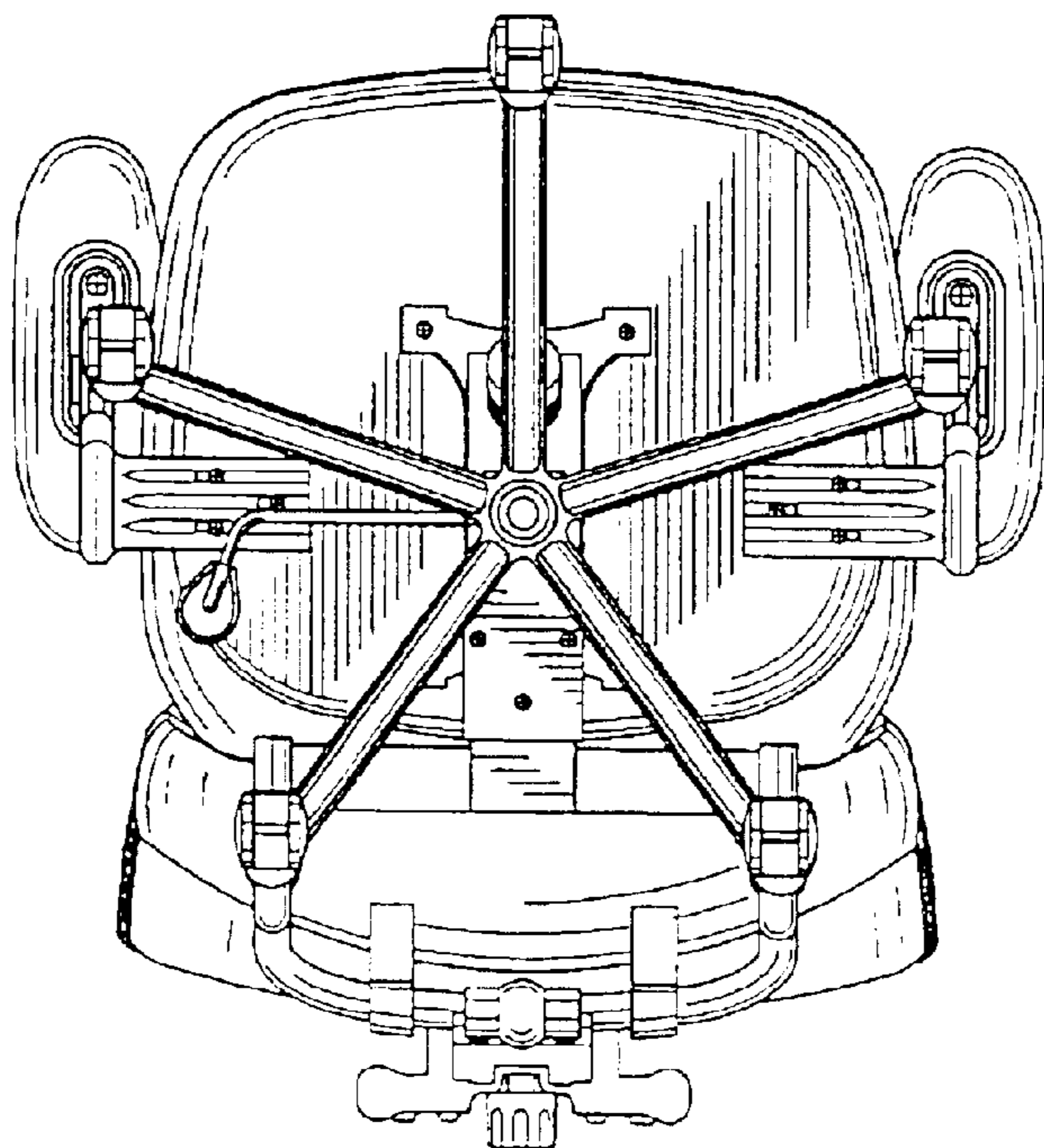

FIG. 7