

US00D496141S1

(12) **United States Design Patent**
Tepper et al.

(10) **Patent No.:** US D496,141 S
(45) **Date of Patent:** ** Sep. 21, 2004

(54) **PET CHEW WITH 8 BUTTONS**
(75) Inventors: **Jacob Tepper**, Boca Raton, FL (US);
Steven Mendal, New York, NY (US);
Dean Triandafellos, Freehold, NJ (US)

(73) Assignee: **Petra Pet, Inc.**, Carlstadt, NJ (US)

(**) Term: **14 Years**

(21) Appl. No.: **29/179,419**

(22) Filed: **Apr. 9, 2003**

(51) **LOC (7) Cl.** **01-01**

(52) **U.S. Cl.** **D1/106; D30/160; D1/199**

(58) **Field of Search** D30/160, 129,
D30/130; 119/702, 707-711; 446/46, 48;
D21/444, 824; D11/119-121; D24/101-102;
424/464, 467; D1/100, 104, 106, 109, 110,
120, 124-130, 199; 426/92, 104, 284, 499,
500, 512, 513, 514, 516-517, 805-806,
808, 390

(56) **References Cited**

U.S. PATENT DOCUMENTS

4,260,635 A	4/1981	Fisher	
4,364,925 A	12/1982	Fisher	
D291,740 S	* 9/1987	Spiel et al. D1/106
D296,260 S	* 6/1988	Hayes D1/106
D304,385 S	* 11/1989	Spiel et al. D1/106
D305,950 S	* 2/1990	Spiel et al. D1/106

4,921,714 A	5/1990	Matthews et al.	
D375,610 S	* 11/1996	Loring D30/160
D394,414 S	* 5/1998	Catalano D30/160
5,897,893 A	4/1999	Mohilef	
6,129,053 A	10/2000	Markham et al.	
6,202,598 B1	3/2001	Willinger	
6,238,715 B1	5/2001	Baikie	
6,277,420 B1	8/2001	Andersen et al.	
D475,504 S	* 6/2003	Hodgdon D1/130
D487,327 S	* 3/2004	Andersen et al. D1/199

* cited by examiner

Primary Examiner—Cathy Anne MacCormac
(74) *Attorney, Agent, or Firm*—Weingram & Associates, PC

(57) **CLAIM**

We claim the ornamental design for a pet chew with 8 buttons, as shown and described.

DESCRIPTION

FIG. 1 is a perspective view of a pet chew with 8 buttons of the invention;
FIG. 2 is a top plan view thereof;
FIG. 3 is a bottom plan view thereof;
FIG. 4 is a front elevational view thereof;
FIG. 5 is a rear elevational view thereof;
FIG. 6 is a right side elevational view thereof; and,
FIG. 7 is a left side elevational view thereof.

1 Claim, 2 Drawing Sheets

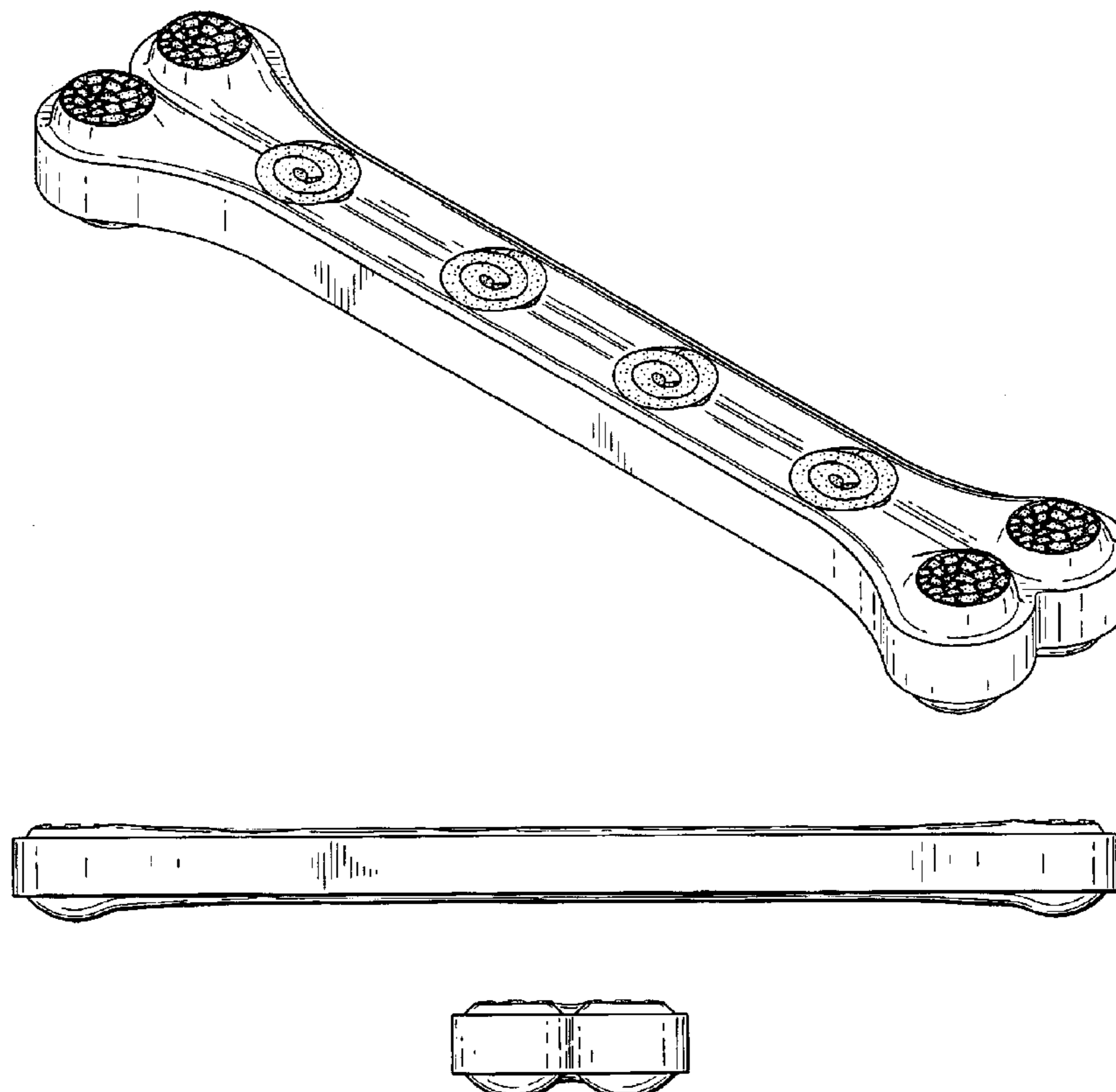

FIG. 1

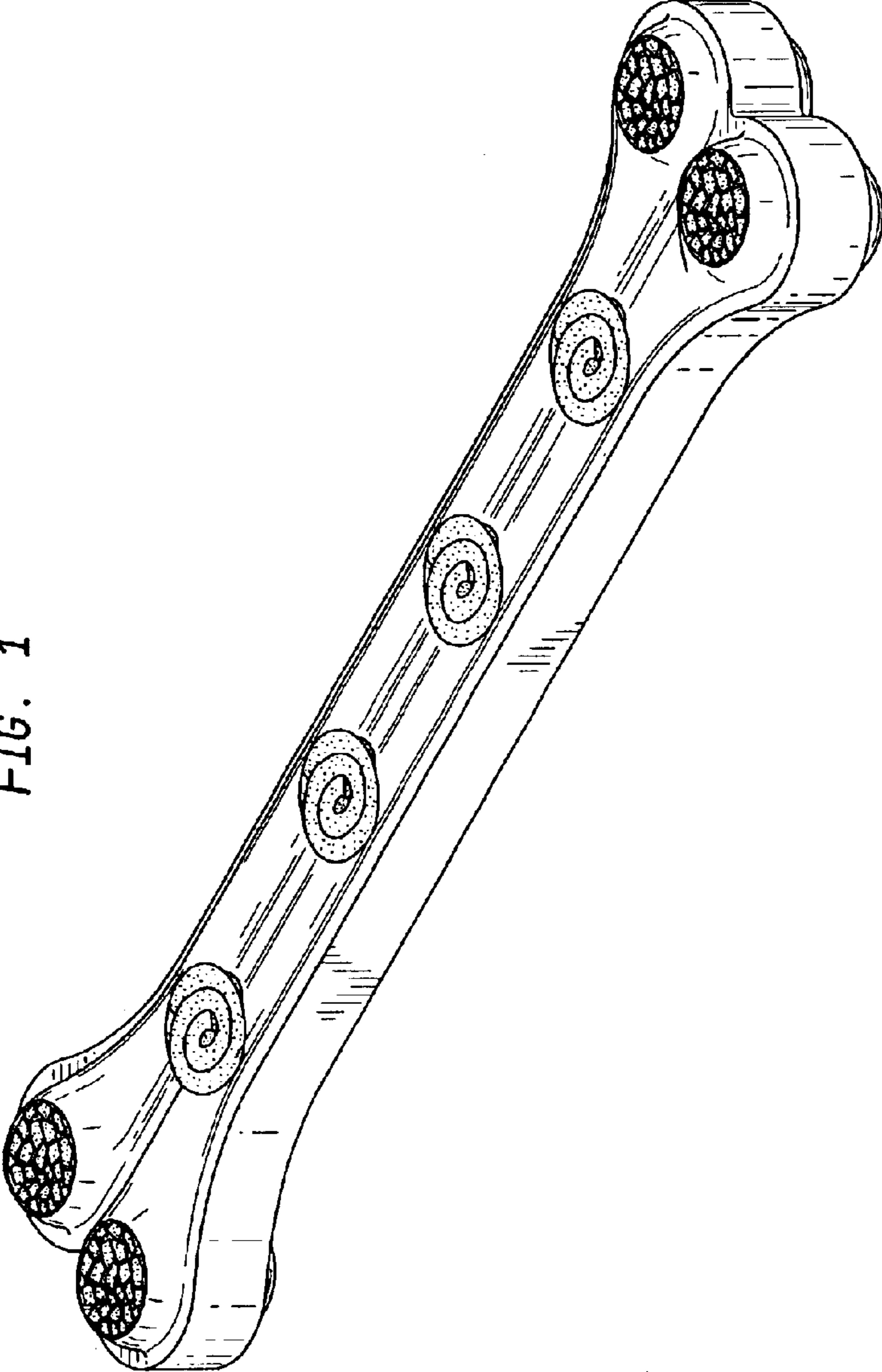

FIG. 2

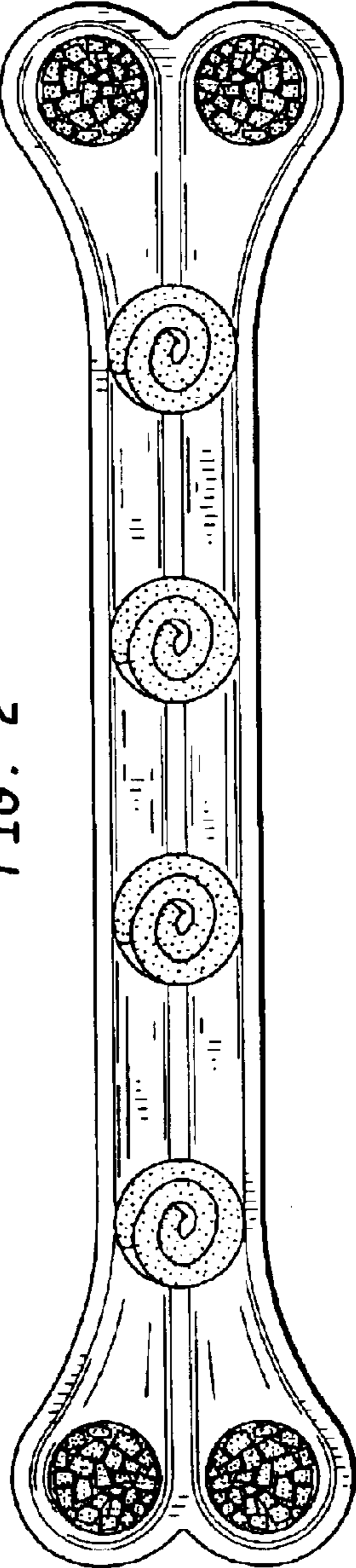

FIG. 3

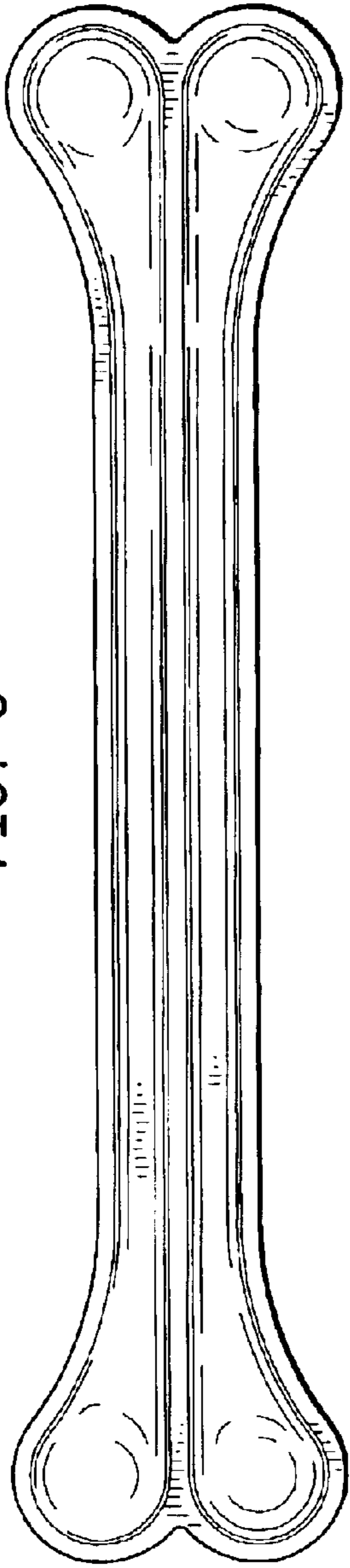

FIG. 4

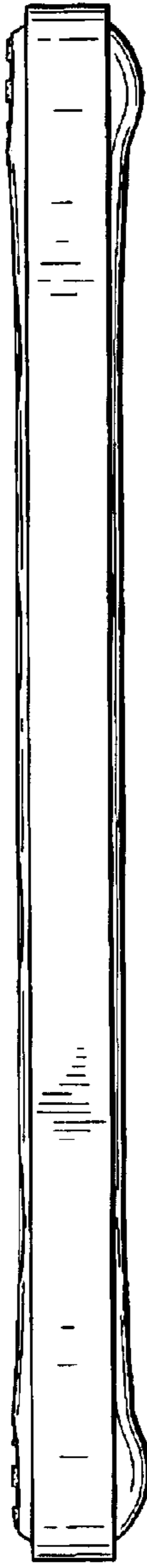

FIG. 5

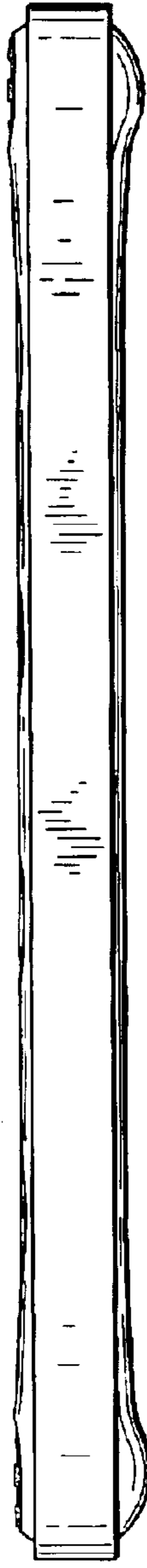

FIG. 6

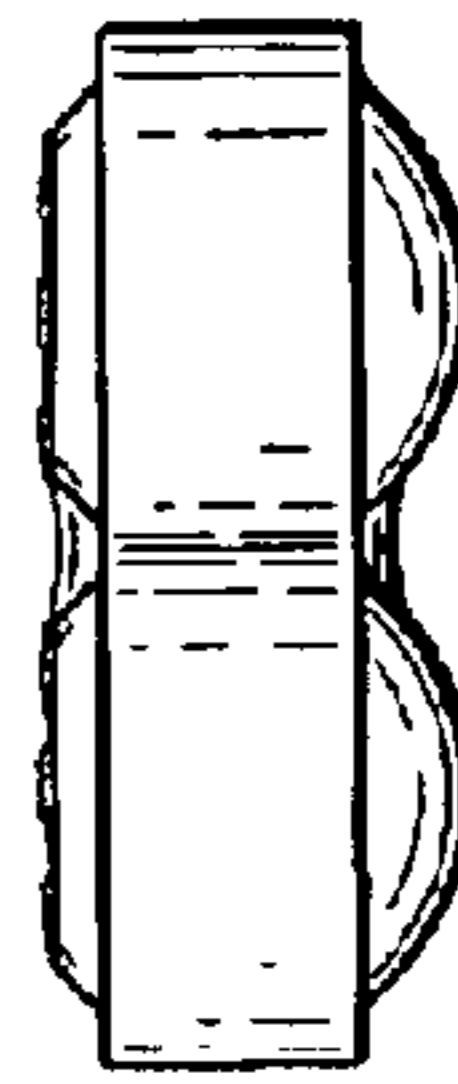

FIG. 7

