

US00D496087S1

(12) **United States Design Patent**
Peterson

(10) **Patent No.:** **US D496,087 S**
(45) **Date of Patent:** **** Sep. 14, 2004**

(54) **INFLATABLE TOWABLE VEHICLE**

D480,443 S * 10/2003 Peterson D21/770
6,648,707 B1 * 11/2003 Peterson 441/66

(75) Inventor: **Leroy L. Peterson**, Omaha, NE (US)

(73) Assignee: **Sportsstuff, Inc.**, Omaha, NE (US)

(**) Term: **14 Years**

(21) Appl. No.: **29/197,561**

(22) Filed: **Jan. 16, 2004**

(51) **LOC (7) Cl.** **21-02**

(52) **U.S. Cl.** **D21/803**

(58) **Field of Search** D21/803, 801,
D21/809, 769, 770; D12/316; 441/66, 35,
129-132, 40-43, 65; 114/345, 346; 472/128,
129

(56) **References Cited**

U.S. PATENT DOCUMENTS

3,490,085	A	*	1/1970	Lewis	114/345
D322,301	S	*	12/1991	Harris	D12/316
5,122,086	A	*	6/1992	Remy	441/66
5,518,431	A	*	5/1996	Staley	441/130
D397,755	S	*	9/1998	Peterson	D21/803
D407,778	S	*	4/1999	Peterson	D21/803
D428,094	S	*	7/2000	Peterson	D21/803
D457,214	S	*	5/2002	Hunter	D21/803

OTHER PUBLICATIONS

Overton's, 2000 -#4, p. 57, "Trio Patriot" towable inflatable vehicle.*

* cited by examiner

Primary Examiner—Lucy Lieberman

(74) *Attorney, Agent, or Firm*—Sturm & Fix LLP

(57) **CLAIM**

The ornamental design for an inflatable towable vehicle, as shown and described.

DESCRIPTION

FIG. 1 is a perspective view of the inflatable towable vehicle showing my new design;

FIG. 2 is a right side elevational view thereof;

FIG. 3 is a left side elevational view thereof;

FIG. 4 is a front elevational view thereof;

FIG. 5 is a rear elevational view thereof;

FIG. 6 is a top plan view thereof; and,

FIG. 7 is a bottom plan view thereof.

The broken lines shown in FIG. 4 are for illustrative purposes only and do not form part of the claimed design.

1 Claim, 3 Drawing Sheets

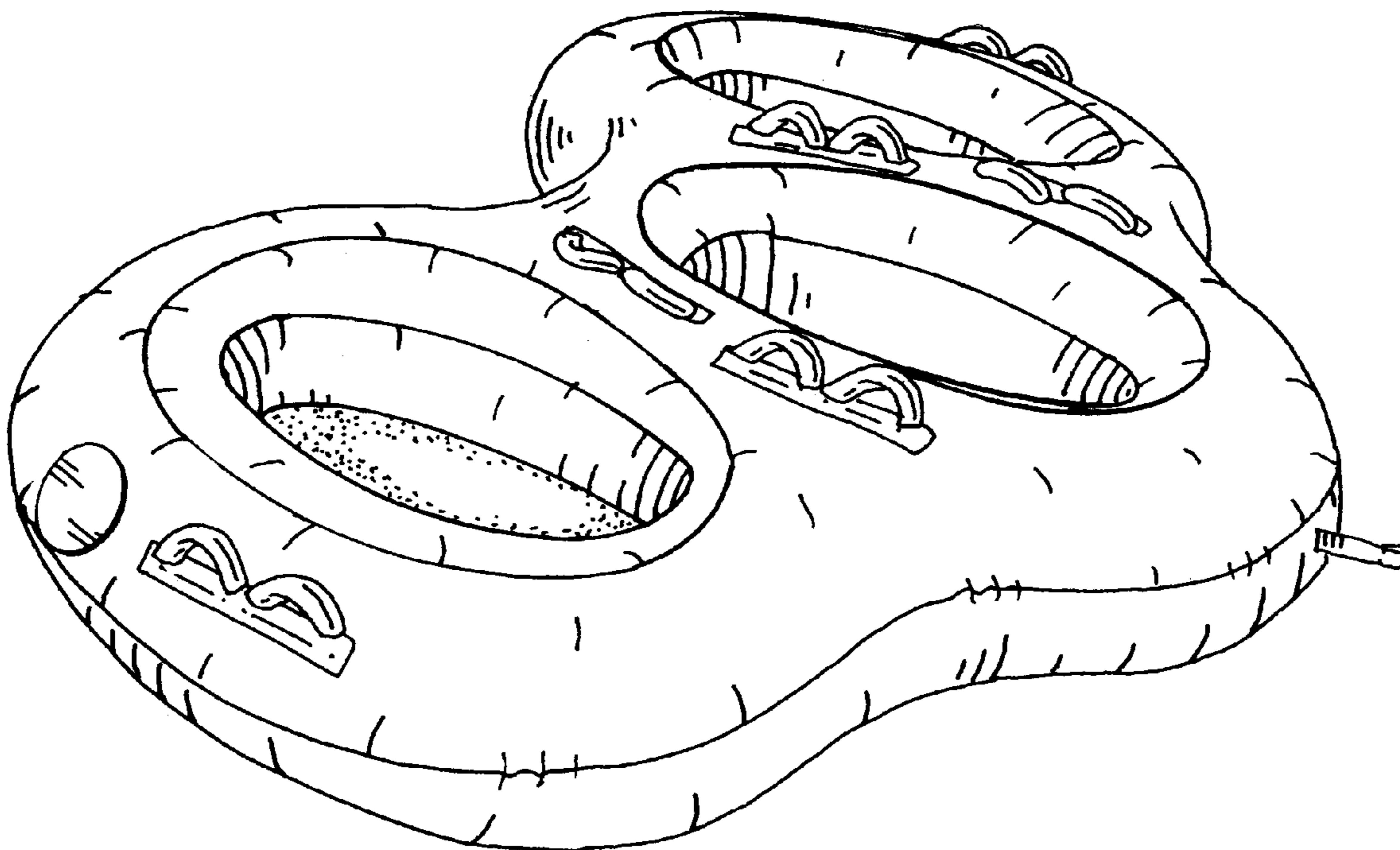

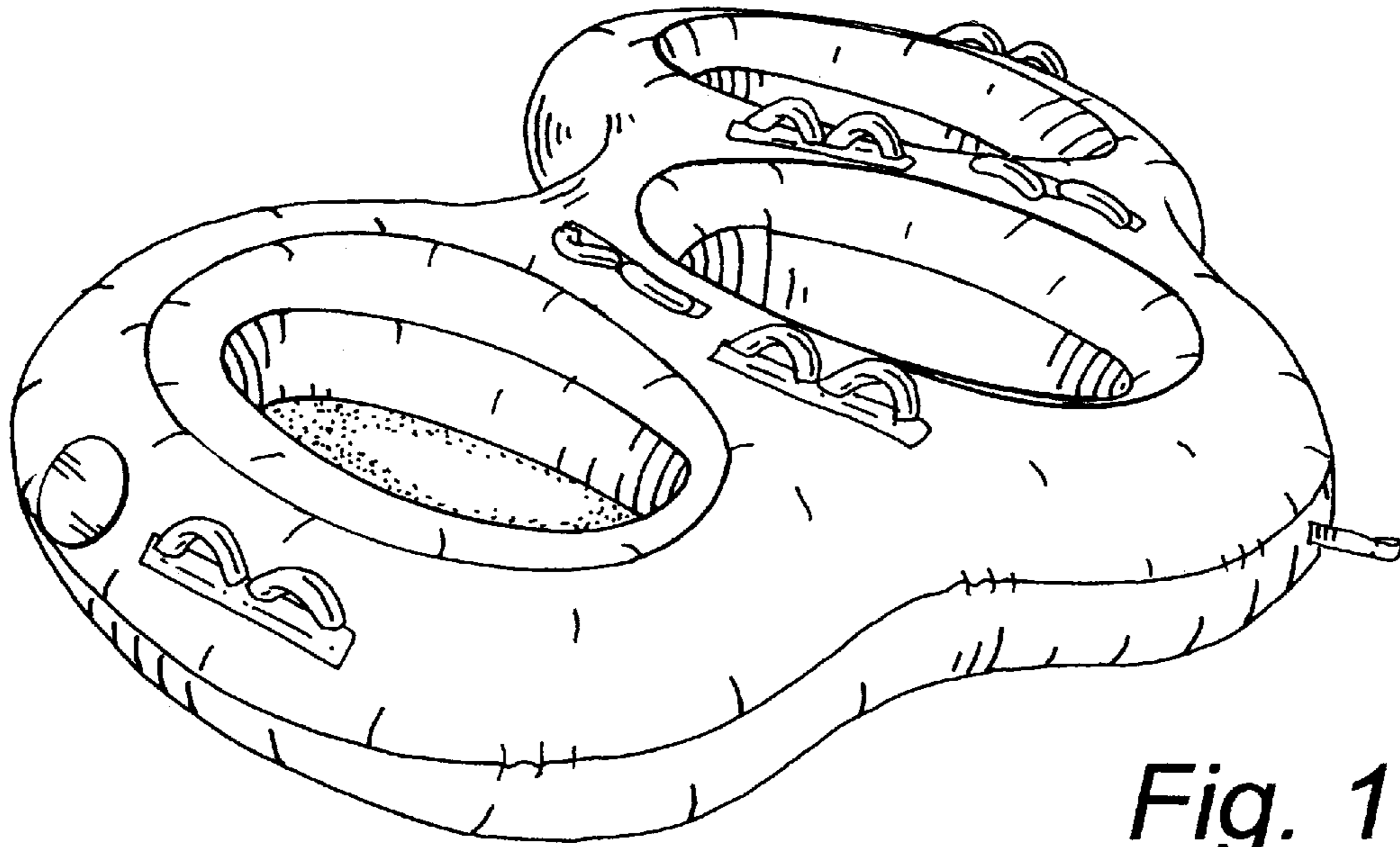

Fig. 1

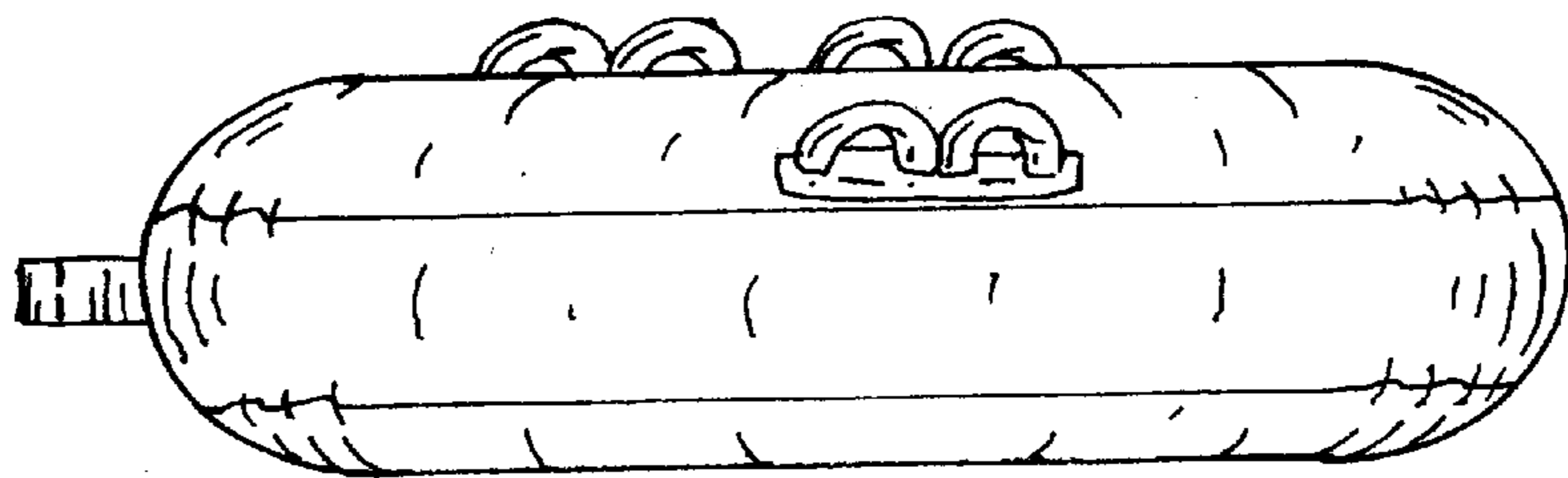

Fig. 2

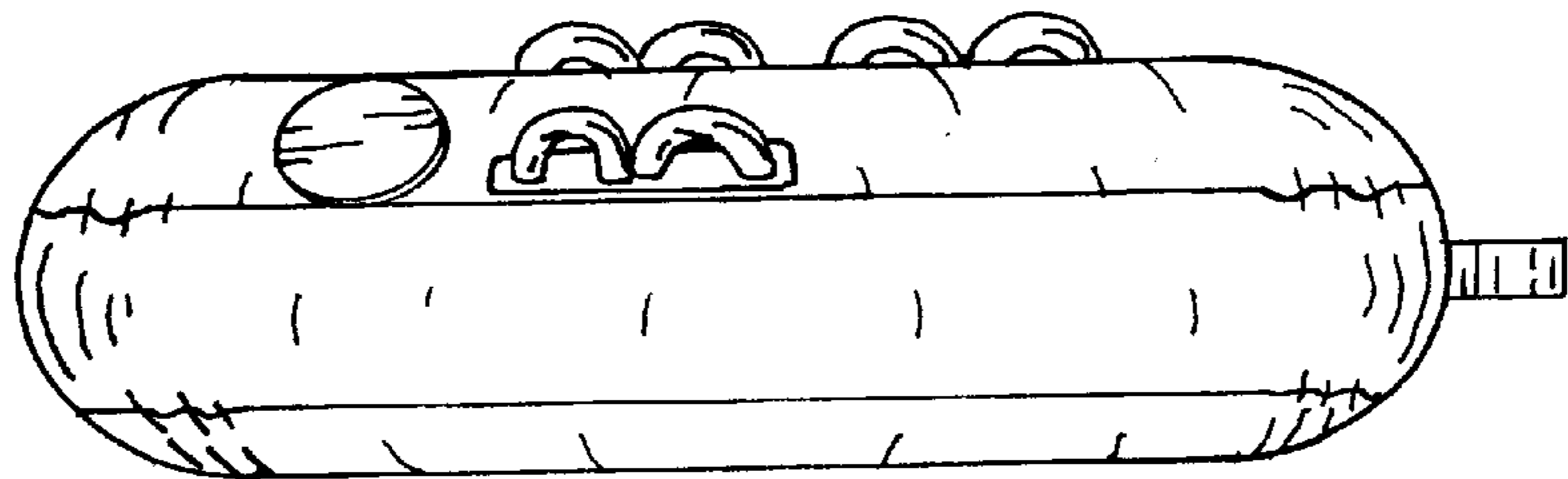

Fig. 3

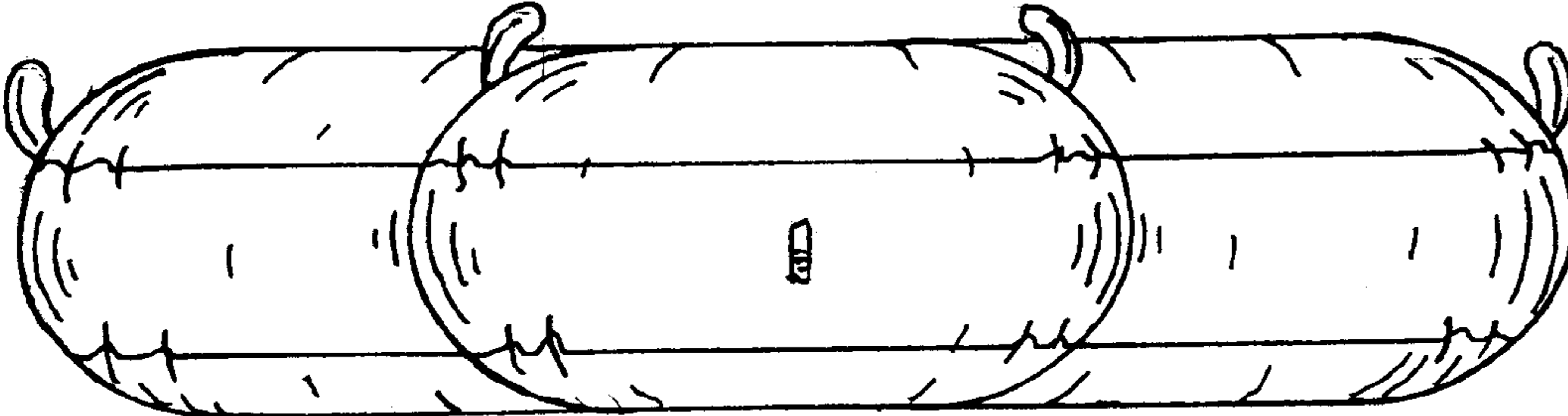

Fig. 4

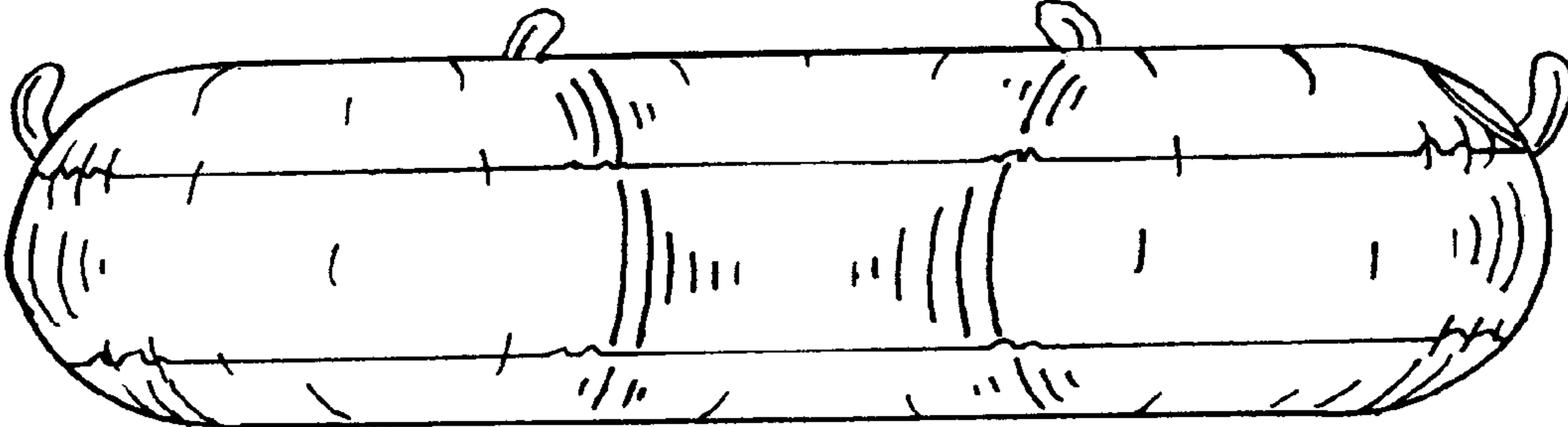

Fig. 5

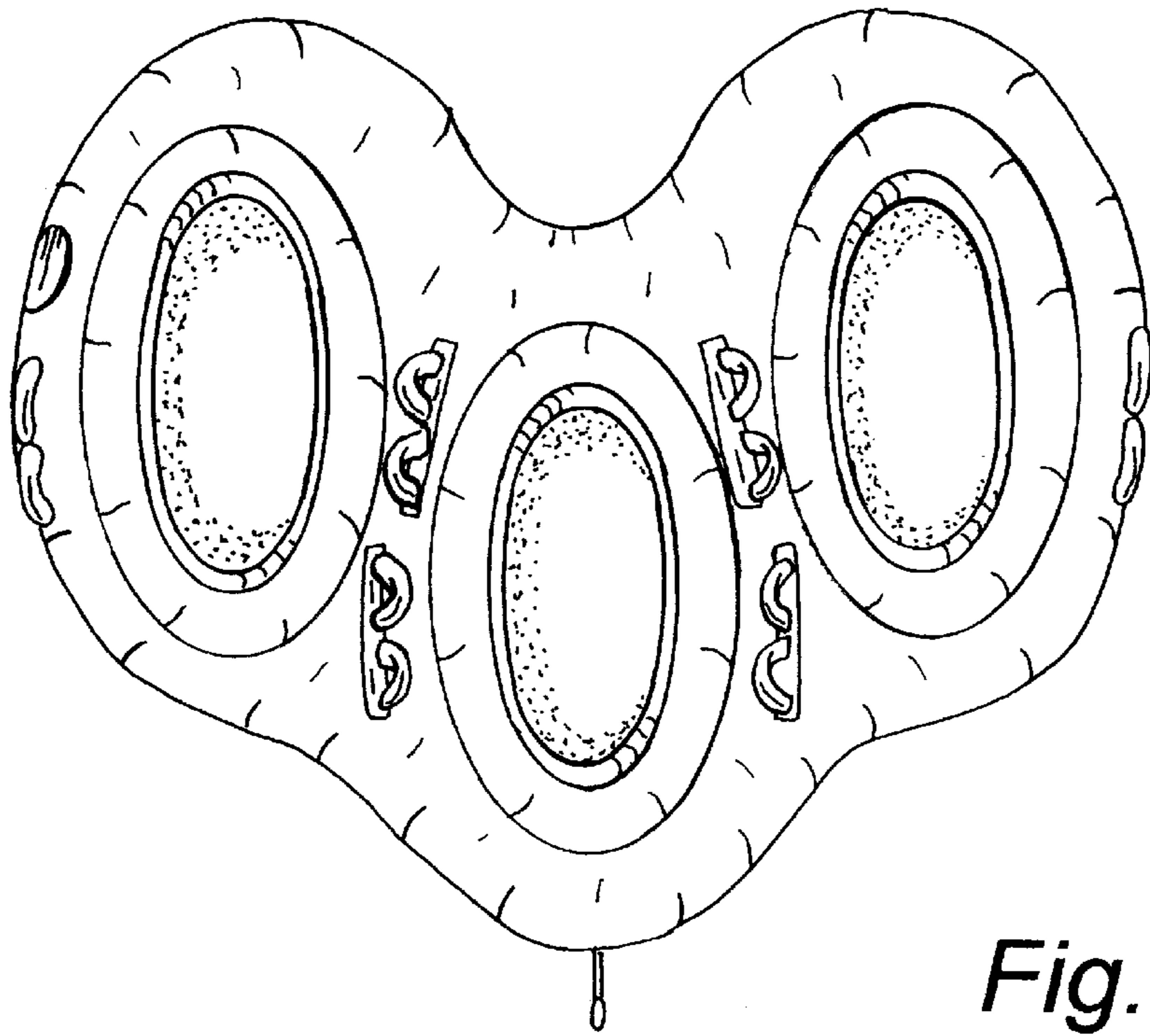

Fig. 6

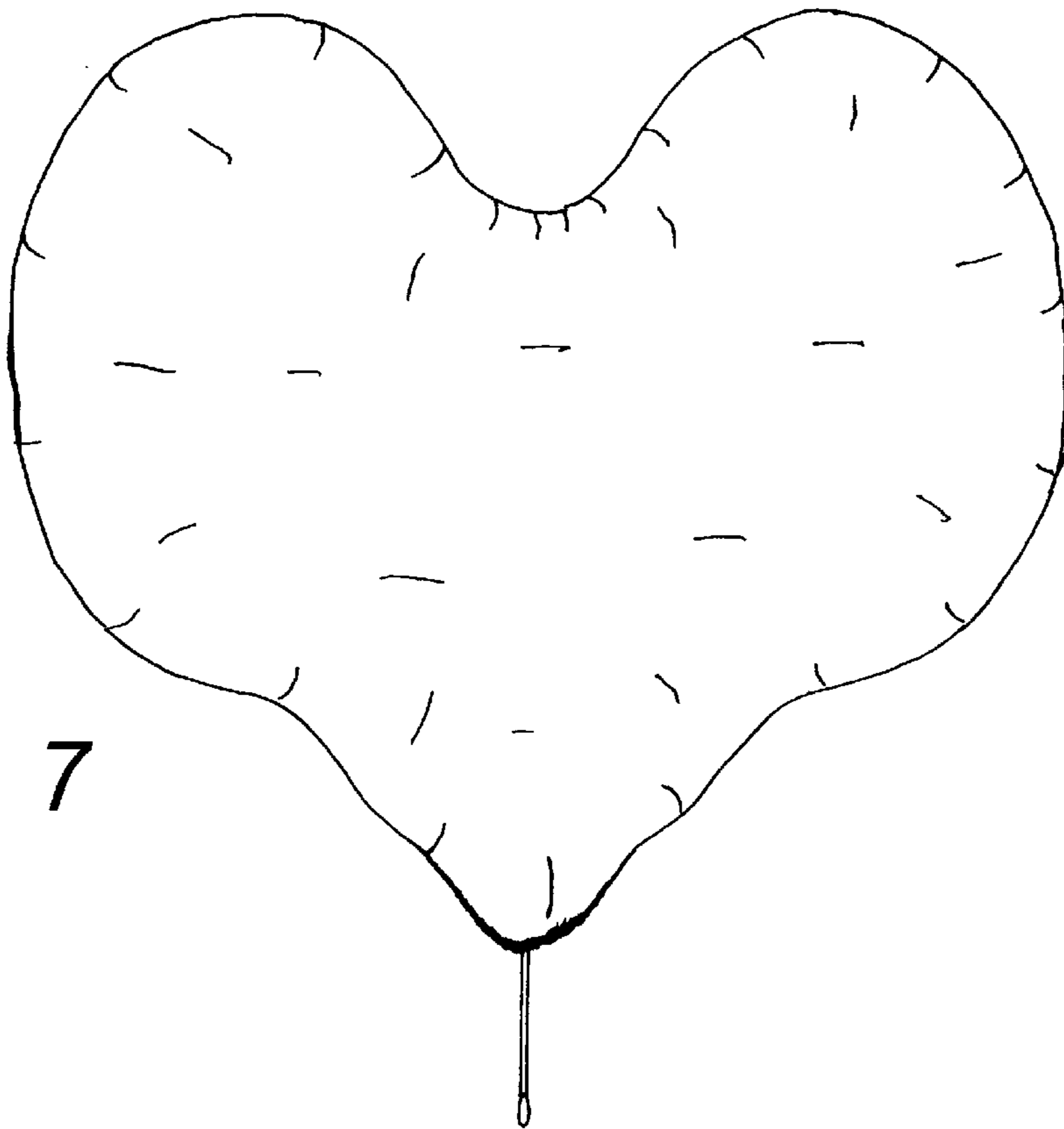

Fig. 7