



US00D496075S1

(12) **United States Design Patent**
Byrne

(10) **Patent No.:** **US D496,075 S**
(45) **Date of Patent:** **** Sep. 14, 2004**

(54) **CAR INCLUDING TOY-CAR, MOTOR-CAR, REPLICAR-CAR AND SCALE-MODEL CAR**

(75) **Inventor:** **Rory Francis Byrne, Modena (IT)**

(73) **Assignee:** **Ferrari S.p.A., Modena (IT)**

(**) **Term:** **14 Years**

(21) **Appl. No.:** **29/187,417**

(22) **Filed:** **Jul. 31, 2003**

(51) **LOC (7) Cl.** **21-01**

(52) **U.S. Cl.** **D21/550**

(58) **Field of Search** D21/419-435,
D21/533, 548-551; D12/108, 83, 87-88;
446/160, 447, 428, 456, 465, 470; 280/1.13,
87.01, 87.021, 828, 87.041, 775

(56) **References Cited**

U.S. PATENT DOCUMENTS

D260,913 S	*	9/1981	Chapman	D12/88
D261,672 S	*	11/1981	Phillippe	D21/550
D311,038 S	*	10/1990	Head	D21/550
D311,994 S	*	11/1990	Tsuji	D21/550
D313,256 S	*	12/1990	Honma	D21/550

D322,331 S	*	12/1991	Tsuji	D21/550
D359,082 S	*	6/1995	Aker et al.	D21/550
D368,743 S	*	4/1996	Amburgey et al.	D21/433
D465,814 S	*	11/2002	Koveleski	D21/551
D471,936 S	*	3/2003	Tilbor et al.	D21/551

* cited by examiner

Primary Examiner—Raphael Barkai

(74) *Attorney, Agent, or Firm*—Robin, Blecker & Daley

(57) **CLAIM**

The ornamental design for a car including toy-car, motor-car, replica-car and scale-model car, as shown and described.

DESCRIPTION

FIG. 1 is a perspective view of the car including toy-car, motor-car, replica-car and scale-model car showing my design thereof;

FIG. 2 is a front view thereof;

FIG. 3 is a left side view thereof;

FIG. 4 is a right side view thereof;

FIG. 5 is a rear view thereof;

FIG. 6 is a top view thereof; and,

FIG. 7 is a bottom view thereof.

1 Claim, 7 Drawing Sheets

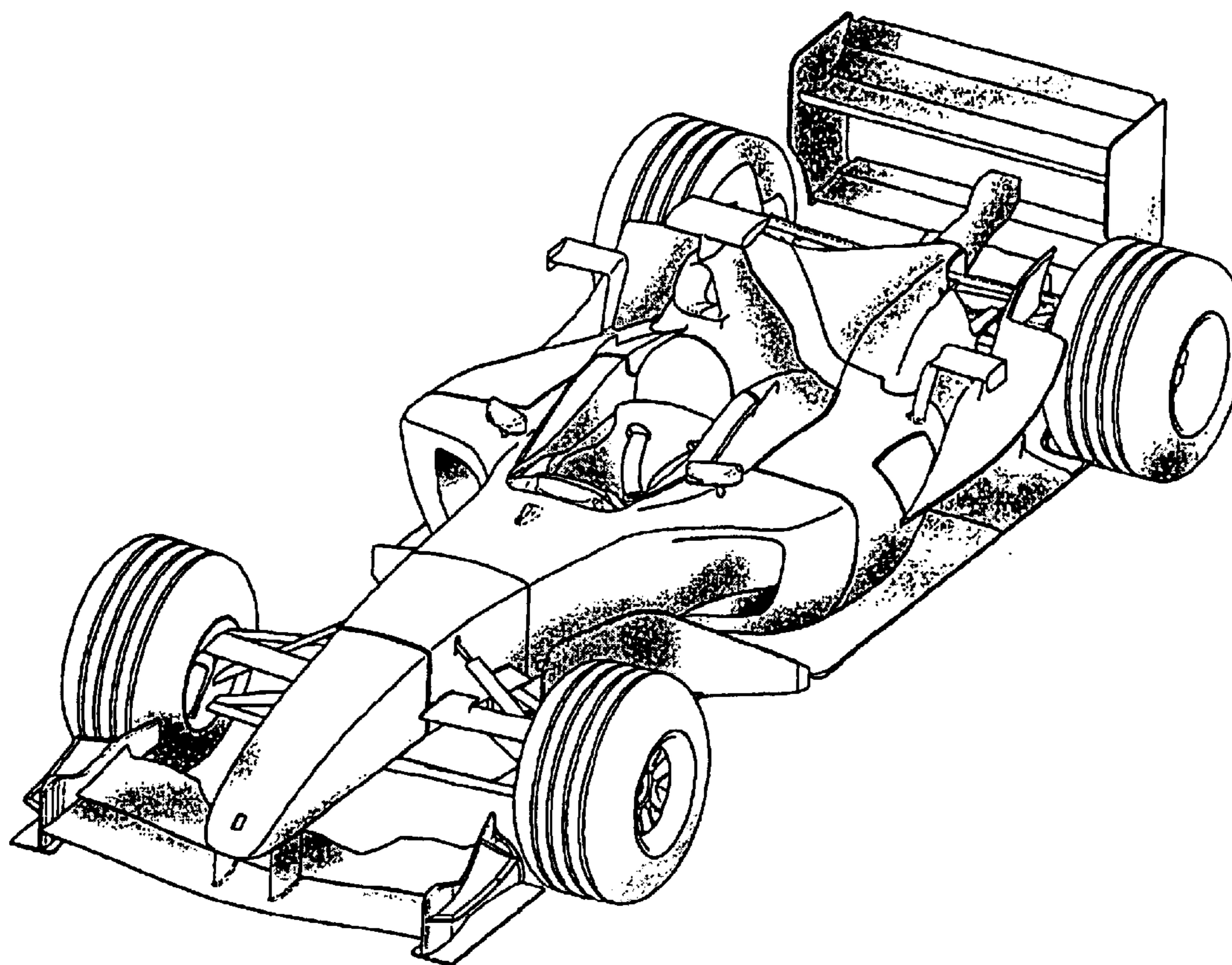

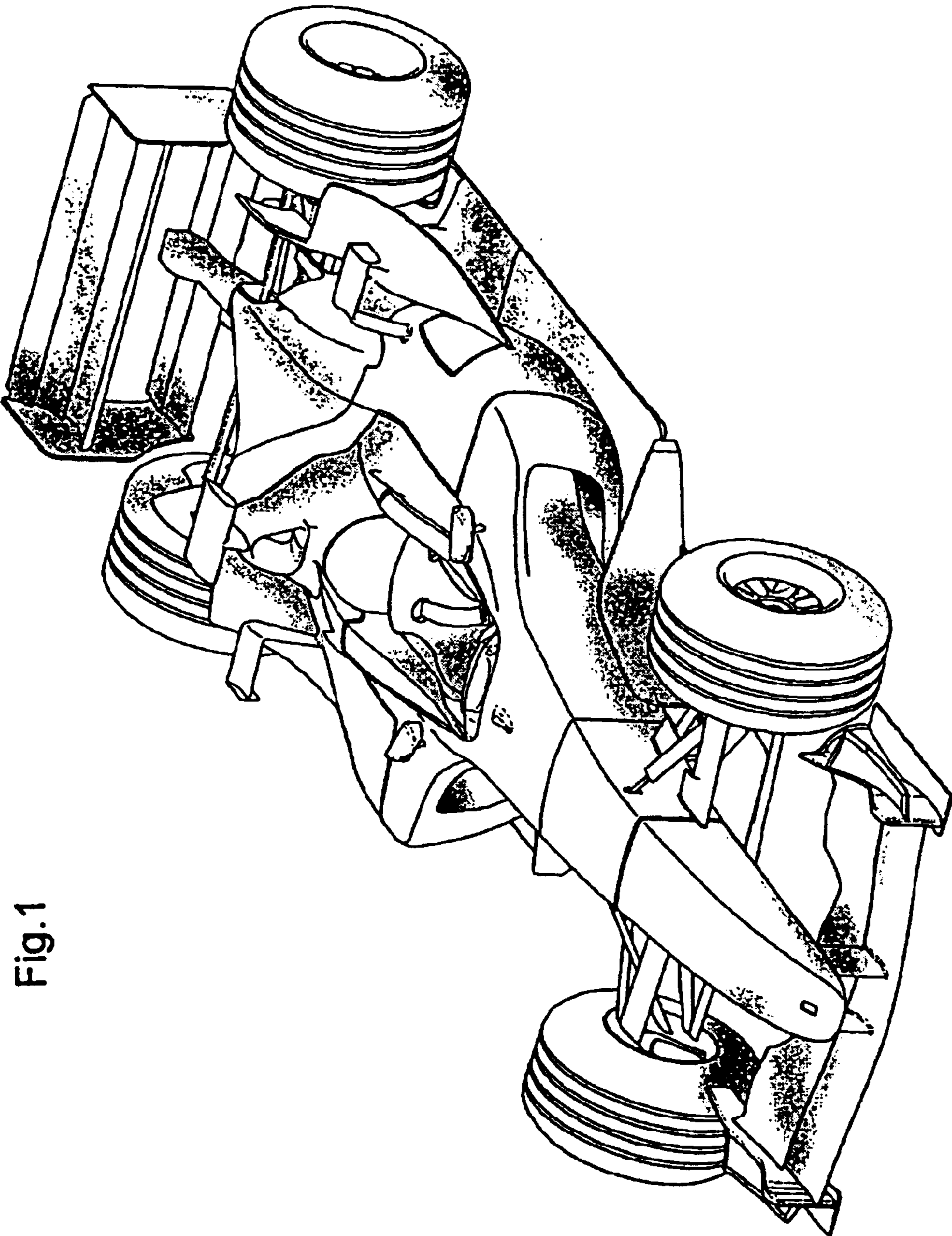
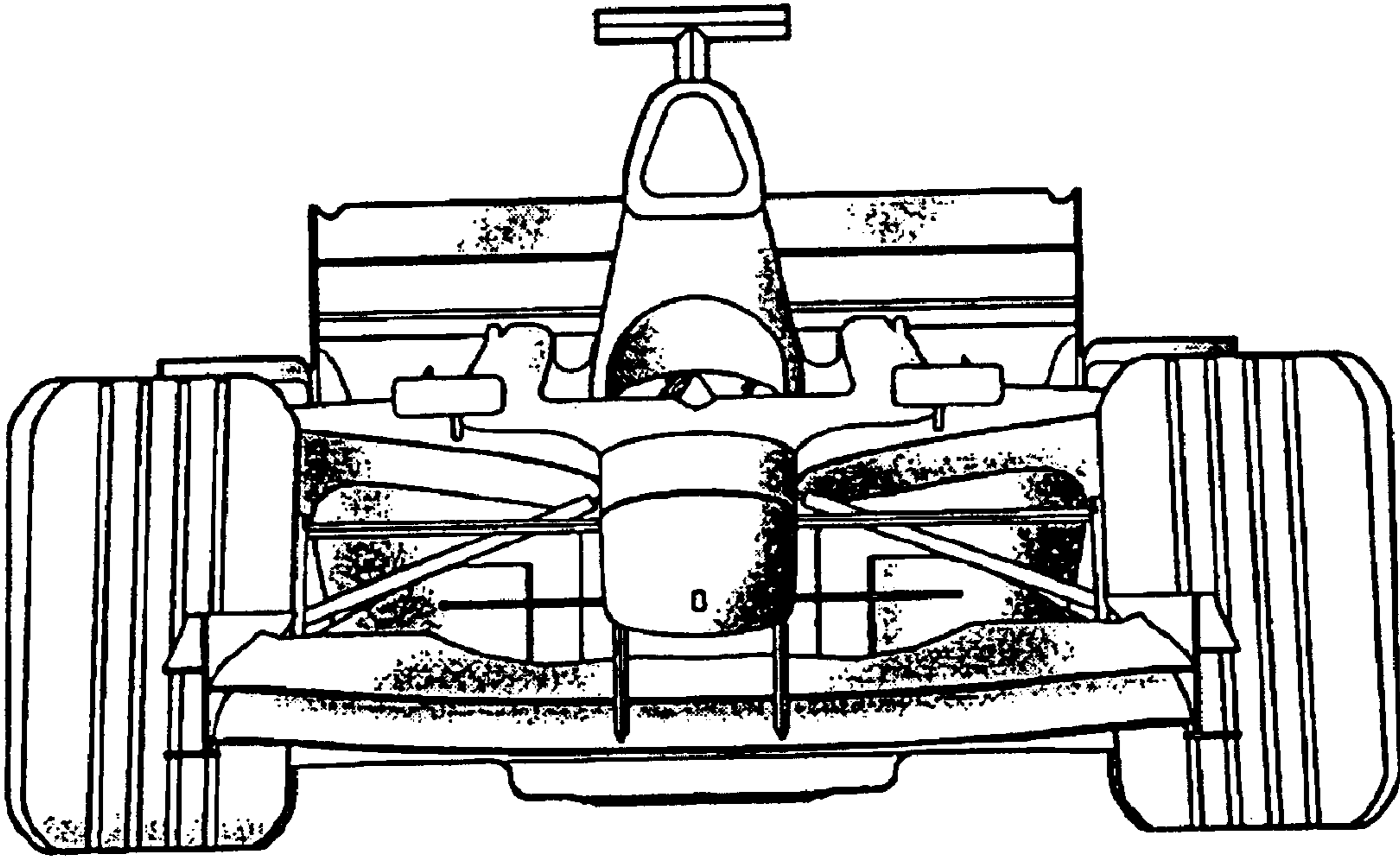

Fig.1

Fig.2



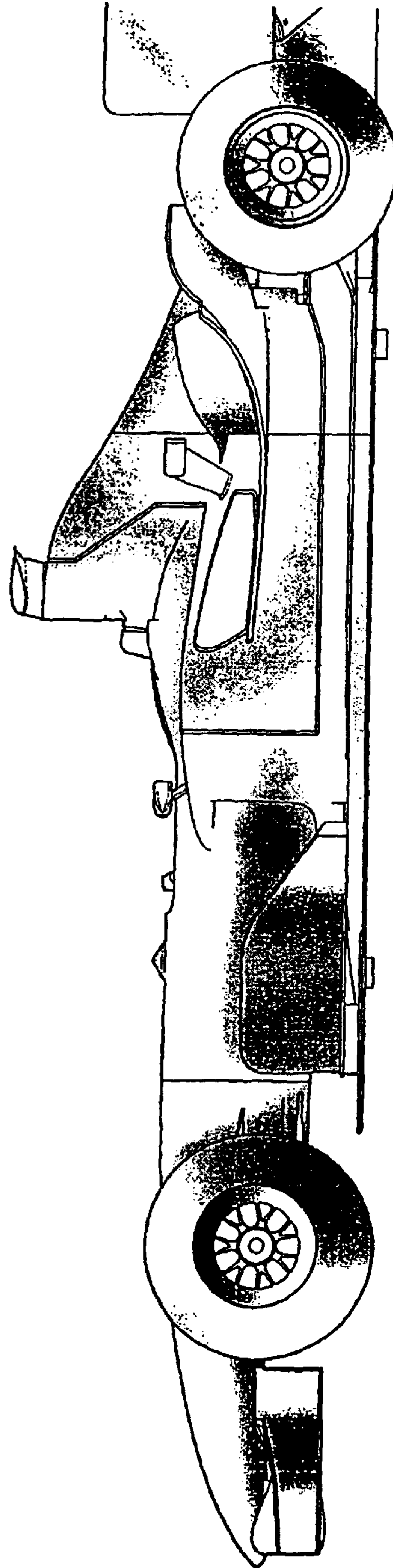

Fig.3

Fig.4

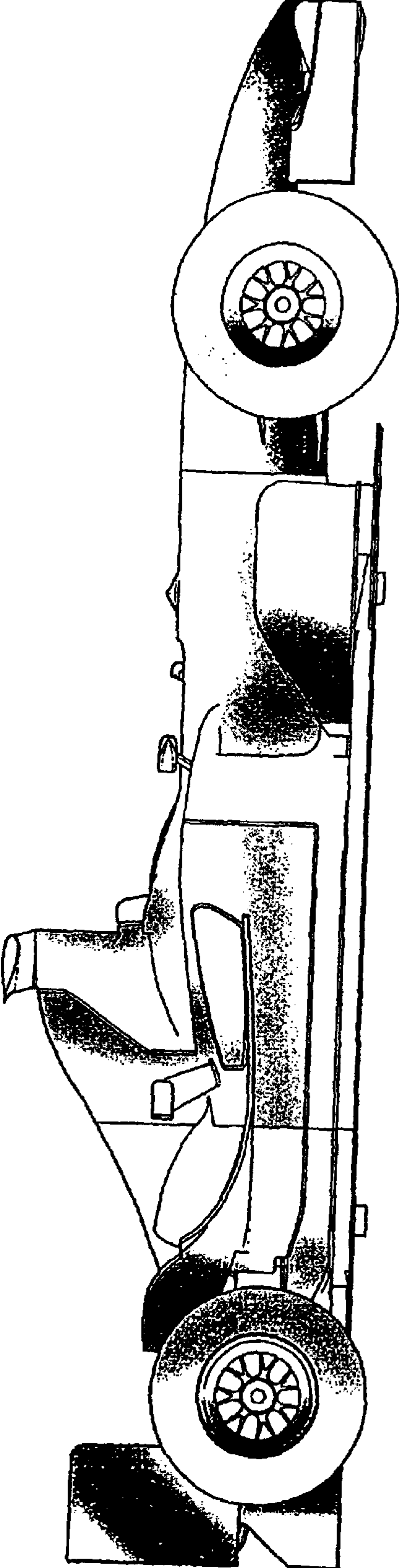

Fig.5

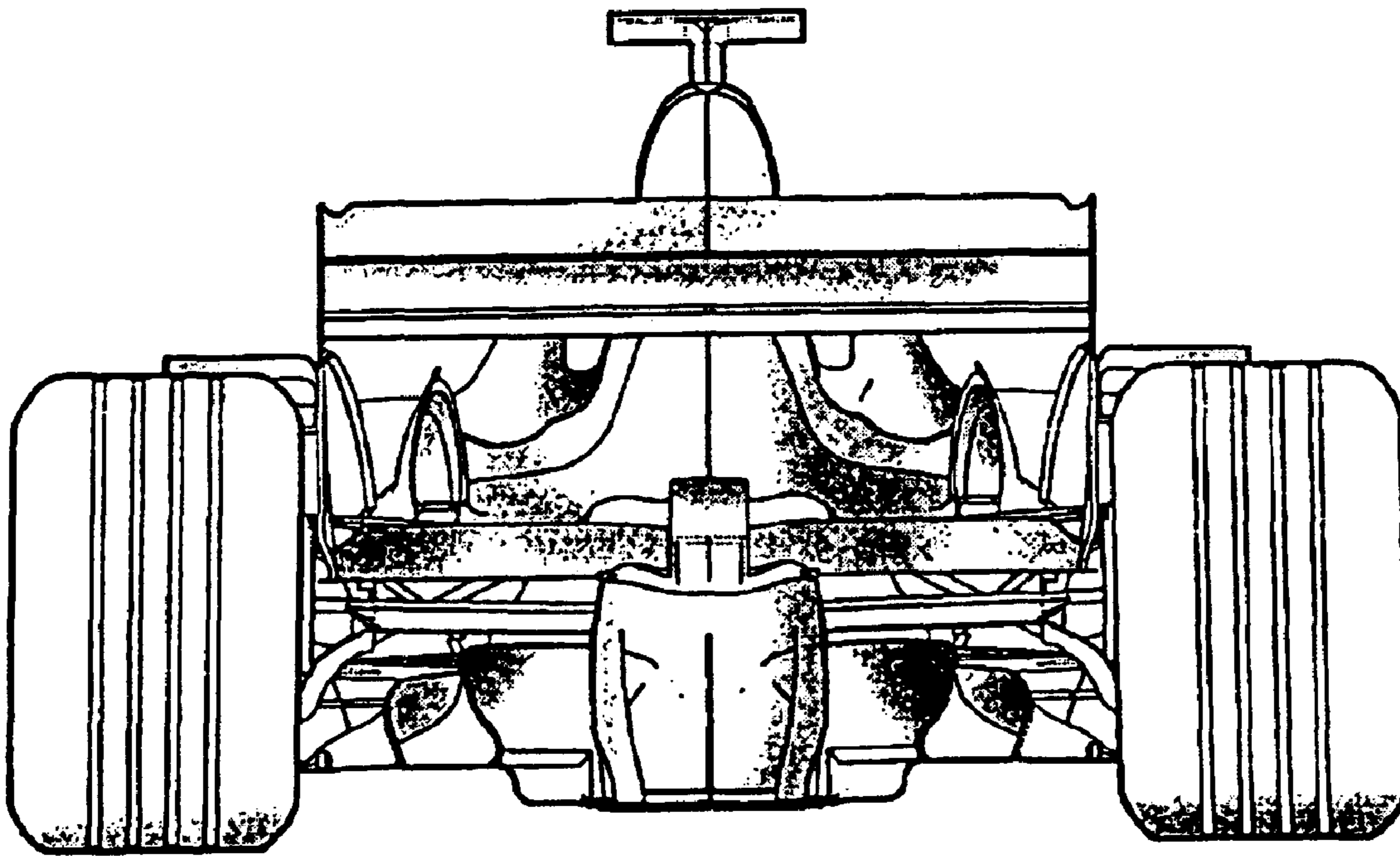

Fig.6

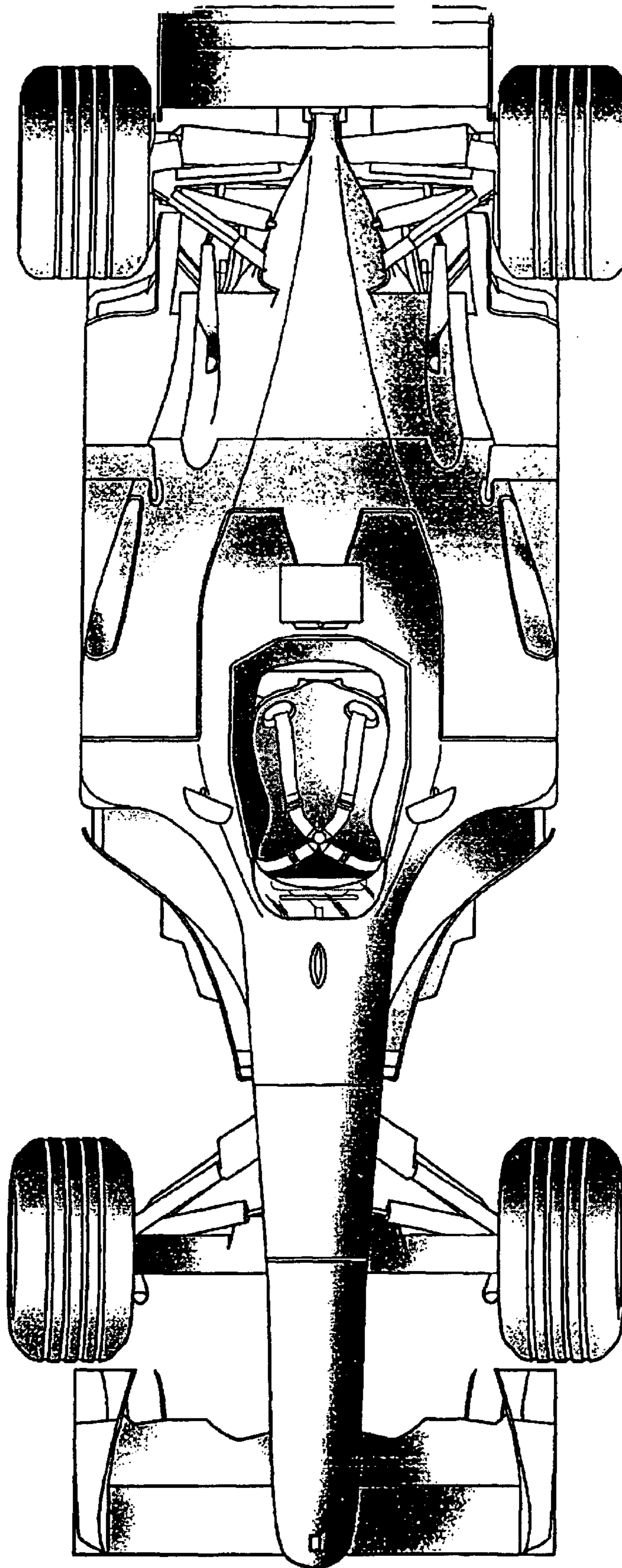

Fig.7

