

US00D495989S1

(12) **United States Design Patent**  
**Kohara**

(10) **Patent No.:** **US D495,989 S**  
(45) **Date of Patent:** **\*\* Sep. 14, 2004**

(54) **CENTER CAR CONSOLE**

(75) **Inventor:** **Junji Kohara, Kyoto (JP)**

(73) **Assignee:** **Kohara Co., Ltd., Kyoto (JP)**

(\*\*) **Term:** **14 Years**

(21) **Appl. No.:** **29/195,890**

(22) **Filed:** **Dec. 18, 2003**

(30) **Foreign Application Priority Data**

Jun. 20, 2003 (JP) ..... 2003-017518

(51) **LOC (7) Cl.** ..... **12-16**

(52) **U.S. Cl.** ..... **D12/424**

(58) **Field of Search** ..... D12/415, 421,  
D12/423-425; 296/37.1-37.8, 37.12-37.16;  
224/539-543, 400, 926; 297/411.2-411.26

(56) **References Cited**

**U.S. PATENT DOCUMENTS**

- 2,524,909 A \* 10/1950 Hines ..... 224/275
- D191,356 S \* 9/1961 Krone ..... D12/421
- D207,902 S \* 6/1967 Bray ..... D12/421
- D251,035 S \* 2/1979 Hart ..... D12/421
- D313,962 S \* 1/1991 Haag et al. .... D12/423
- D358,578 S \* 5/1995 Walker ..... D12/416
- D391,223 S \* 2/1998 Lucas, Jr. .... D12/424
- D399,483 S \* 10/1998 Paredes, Jr. .... D12/424

- D408,349 S \* 4/1999 Smith ..... D12/424
- D411,980 S \* 7/1999 Sacco et al. .... D12/425
- D430,104 S \* 8/2000 McDonald ..... D12/419
- D438,841 S \* 3/2001 Smith ..... D12/424

**FOREIGN PATENT DOCUMENTS**

JP 2002-13668 5/2002

\* cited by examiner

*Primary Examiner*—Stacia Cadmus

(74) *Attorney, Agent, or Firm*—Kirschstein, et al.

(57) **CLAIM**

The ornamental design for a center car console, as shown and described.

**DESCRIPTION**

FIG. 1 is a right side elevation view of a center car console according to this invention;  
 FIG. 2 is a left side elevation view thereof;  
 FIG. 3 is a front elevation view thereof;  
 FIG. 4 is a rear elevation view thereof;  
 FIG. 5 is a top plan view thereof;  
 FIG. 6 is a bottom plan view thereof;  
 FIG. 7 is an enlarged sectional view taken along the line 7-7 of FIG. 3; and,  
 FIG. 8 is an exploded perspective view thereof.

**1 Claim, 5 Drawing Sheets**

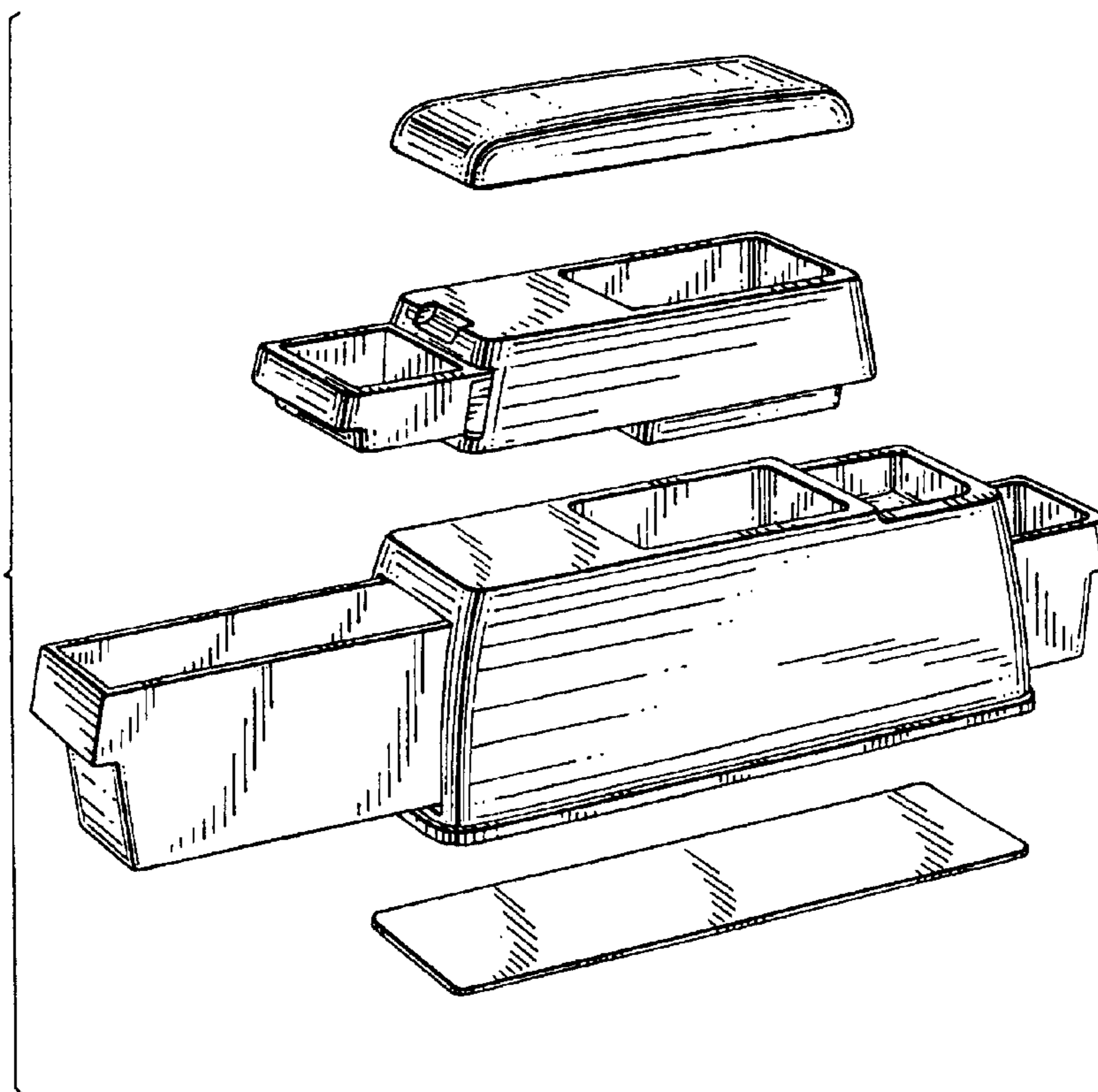

*FIG. 1*

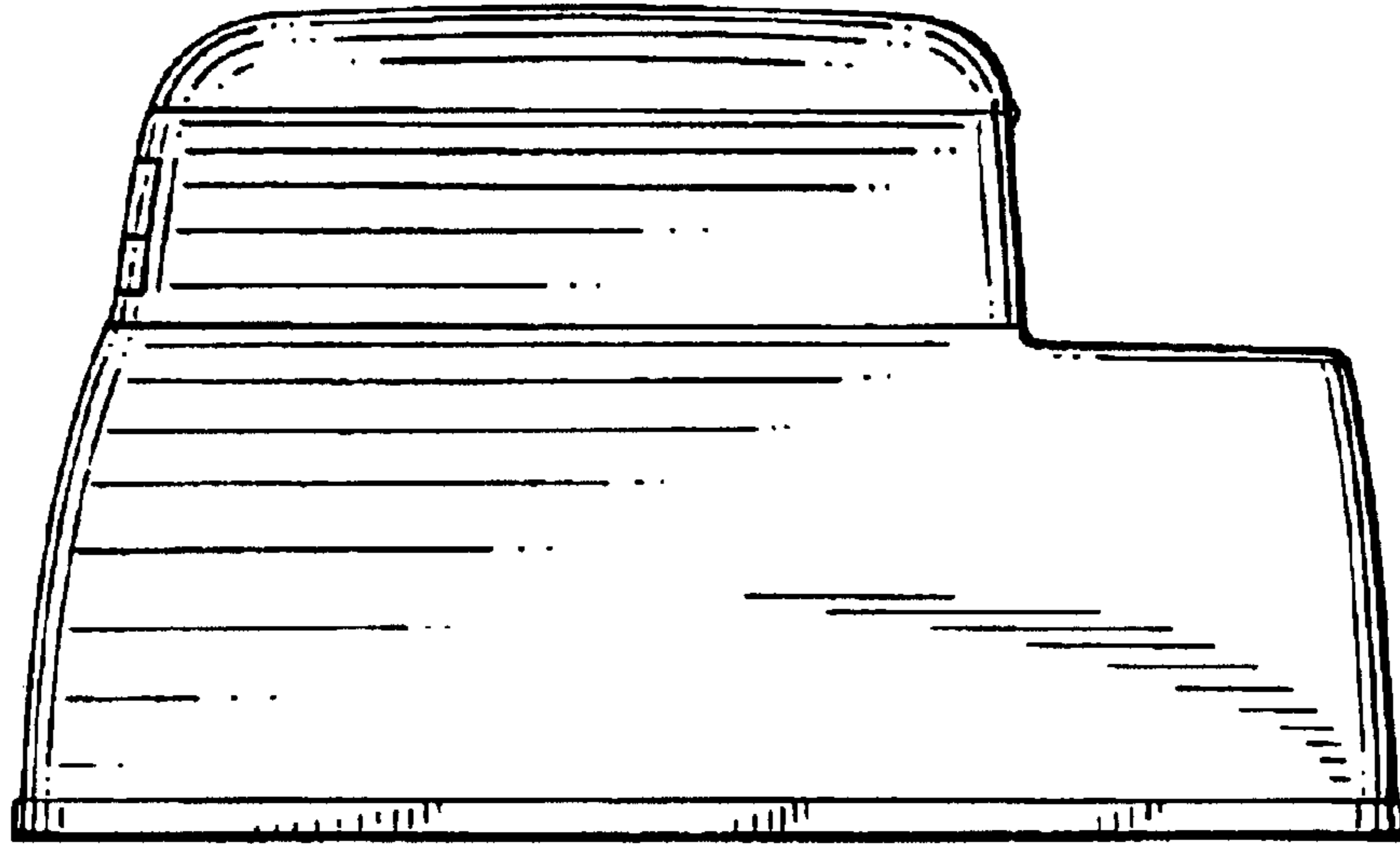

*FIG. 2*

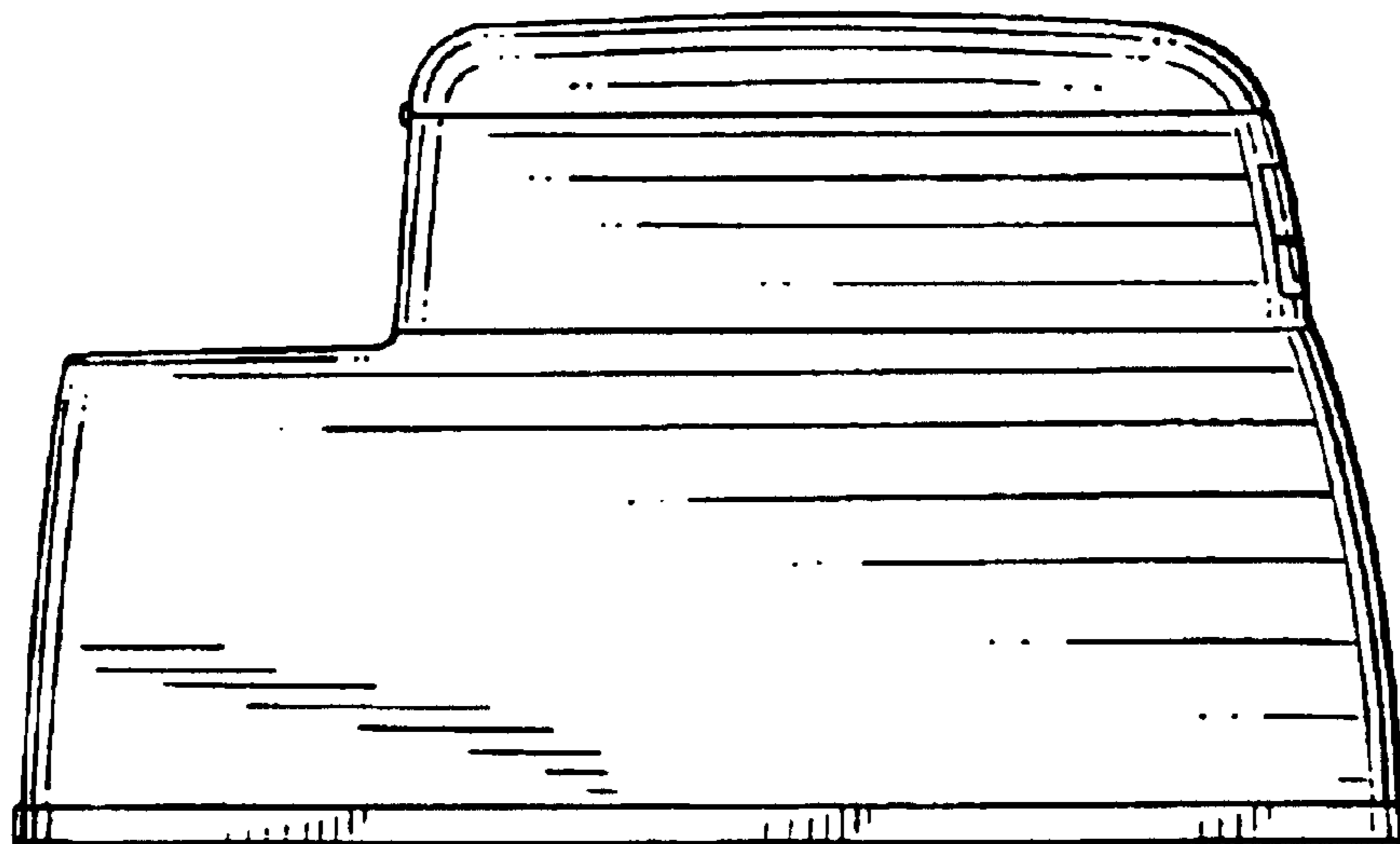

*FIG. 3*

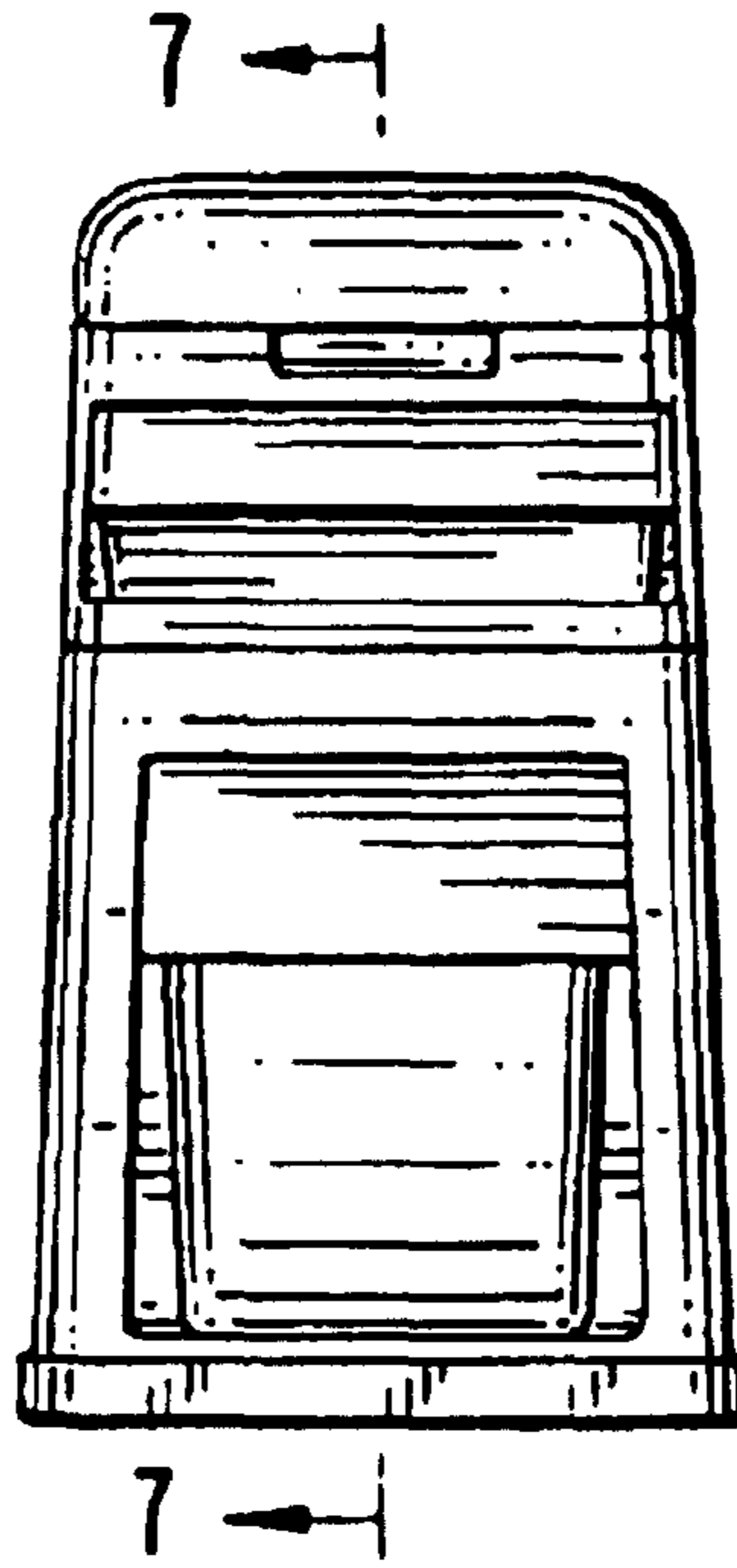

*FIG. 4*

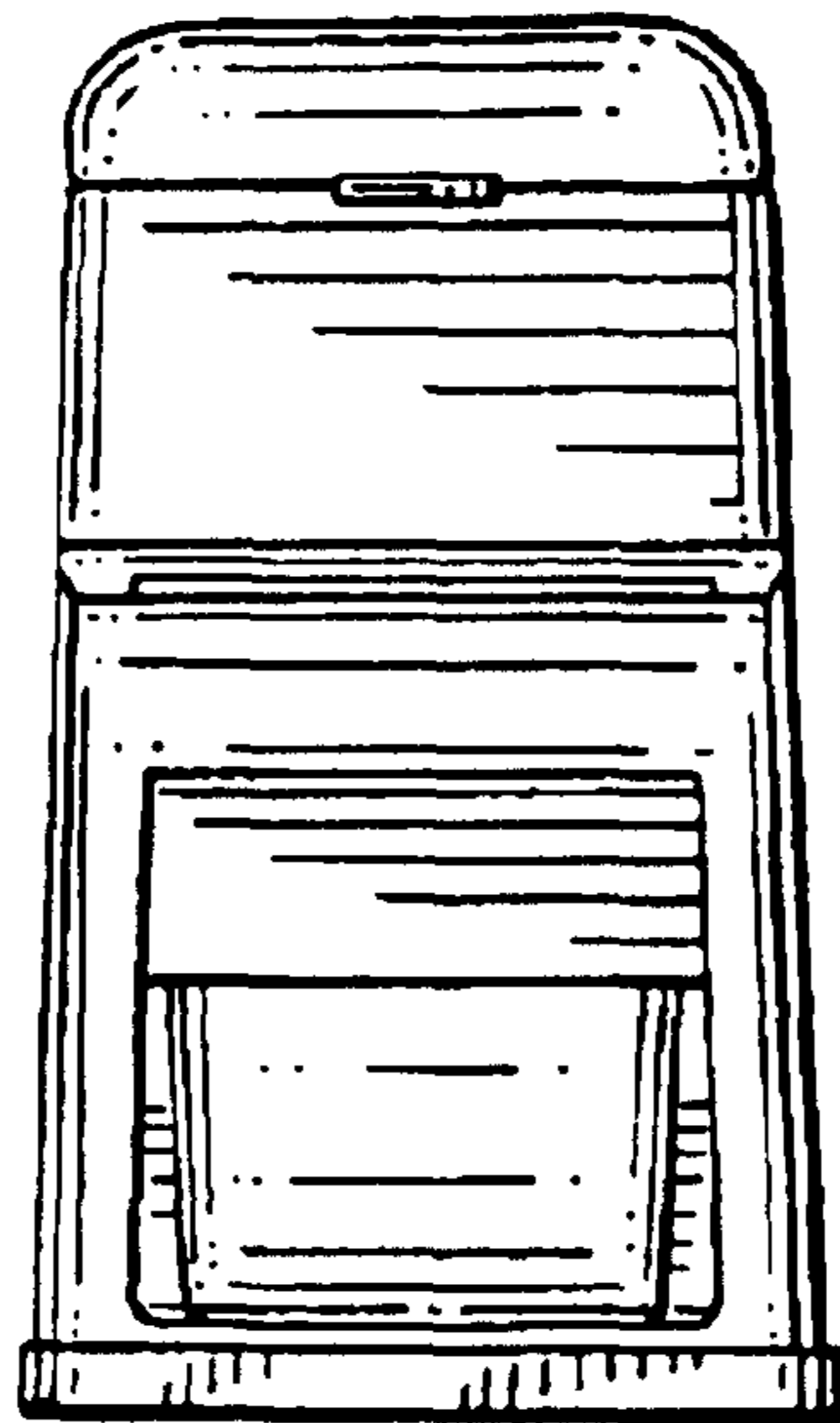

*FIG. 5*

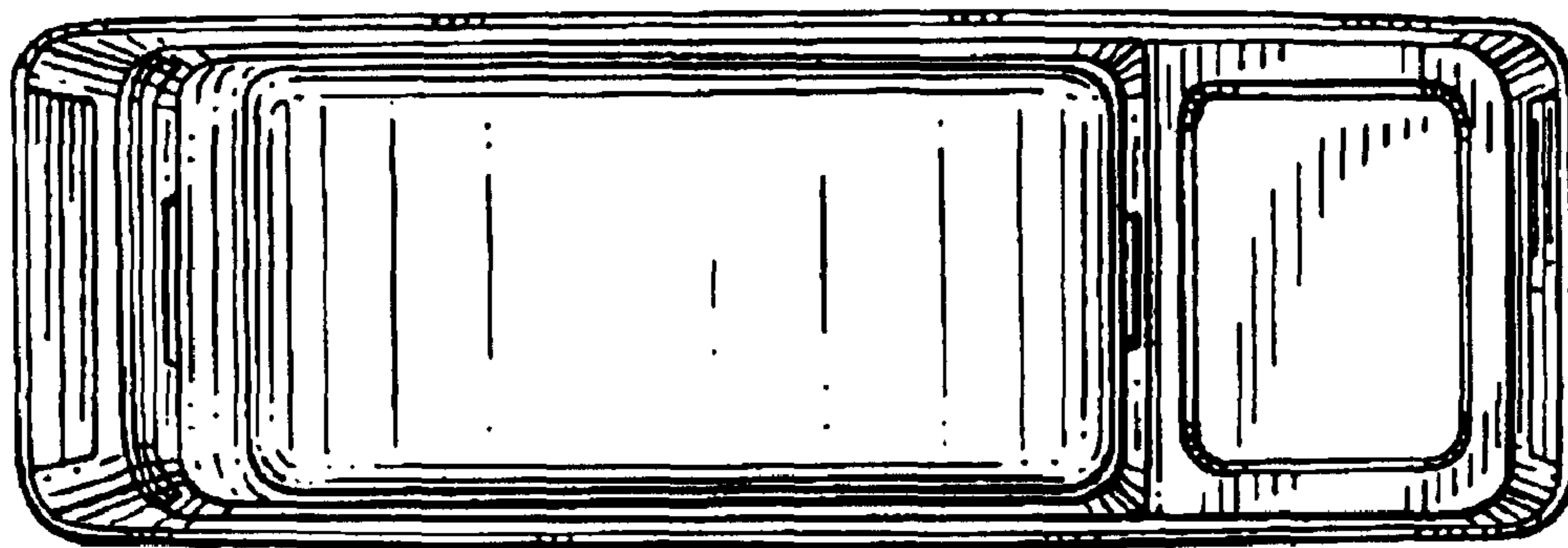

*FIG. 6*

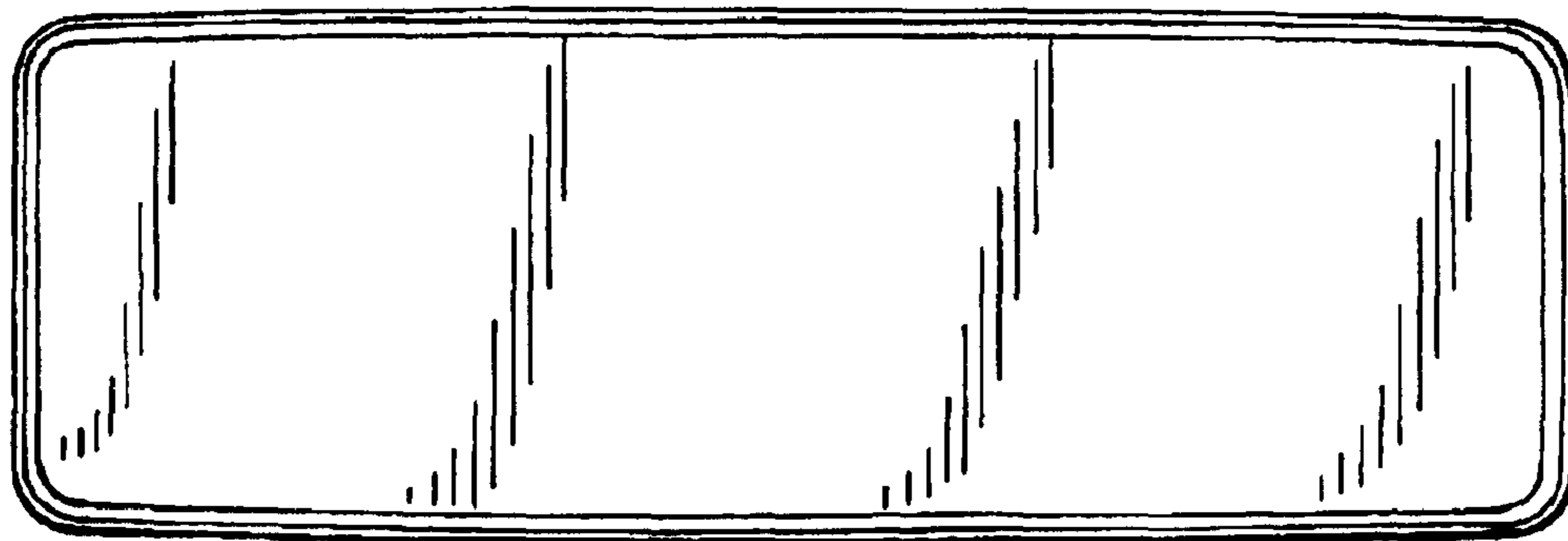

FIG. 7

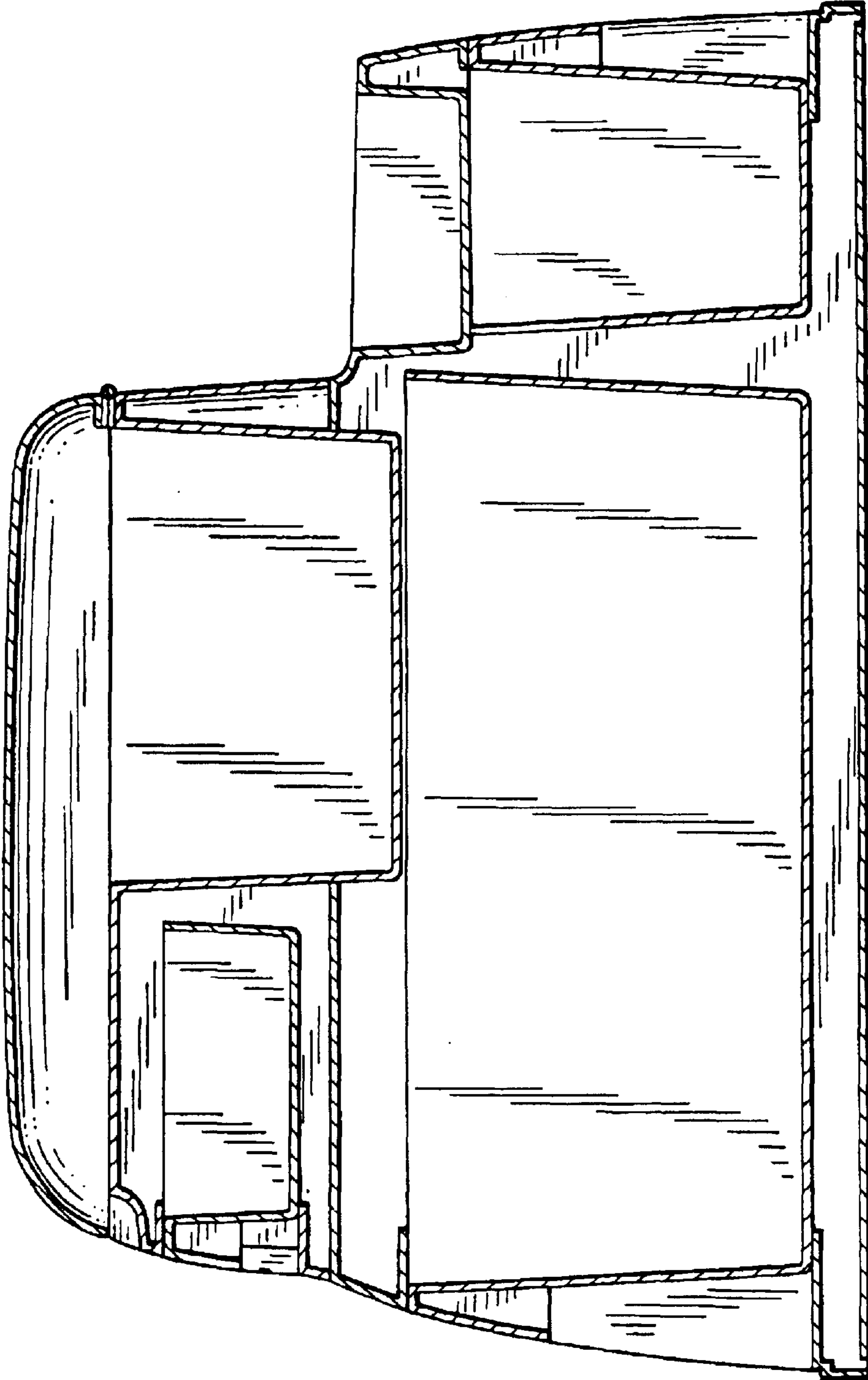

FIG. 8

