

US00D495877S1

(12) **United States Design Patent**
Thorsen

(10) **Patent No.: US D495,877 S**
(45) **Date of Patent: ** Sep. 14, 2004**

(54) **HANDBAG**

(75) **Inventor: Jennifer Thorsen, Bensalem, PA (US)**

(73) **Assignee: J. L. Thorsen Brands, LLC,**
Bensalem, PA (US)

(**) **Term: 14 Years**

(21) **Appl. No.: 29/198,307**

(22) **Filed: Jan. 28, 2004**

(51) **LOC (7) Cl. 03-01**

(52) **U.S. Cl. D3/246**

(58) **Field of Search** 150/105, 107,
150/114, 117, 103, 104, 106, 111, 127,
128, 130, 900; D3/232, 233, 241, 243,
245, 246, 244, 234, 238, 301, 303; 190/103,
109, 113, 115, 900, 903, 1, 102, 104, 105,
106, 107, 110, 902; 383/6, 31, 37, 38, 40,
66, 78, 2, 4, 120

(56) **References Cited**

U.S. PATENT DOCUMENTS

1,978,971 A	*	10/1934	Thornhill et al.	150/105
2,544,493 A	*	3/1951	Filebaum	150/111
D171,520 S	*	2/1954	Sprading	D3/244
3,186,461 A	*	6/1965	Erickson	150/128
3,414,033 A	*	12/1968	Tucker	150/107
4,112,991 A	*	9/1978	Barbaresi	150/107

4,649,974 A	*	3/1987	Takanashi	150/130
4,804,122 A	*	2/1989	Knox	150/111
6,422,278 B1	*	7/2002	Grogan	150/105
6,446,688 B1	*	9/2002	Sutton	150/105
D467,072 S	*	12/2002	Grassi Damiani	D3/243

* cited by examiner

Primary Examiner—Louis S. Zarfes

Assistant Examiner—Monica A. Weingart

(74) *Attorney, Agent, or Firm*—Richard C. Weinblatt, Esq.;
Wolf, Block, Schorr and Solis-Cohen, LLP

(57) **CLAIM**

The ornamental design for a handbag, as shown and described.

DESCRIPTION

FIG. 1 is a perspective view showing the present invention. FIG. 2 is a front view (which is identical to the rear view) of the present invention.

FIG. 3 is a side view showing the present invention.

FIG. 4 is a bottom view showing the present invention.

FIG. 5 is a top view showing the present invention; and,

FIG. 6 is a perspective view showing the present invention in an open position.

The broken line showing of handles, in FIGS. 1–3, 5 and 6, is for illustrative purposes only and forms no part of the claimed design.

1 Claim, 6 Drawing Sheets

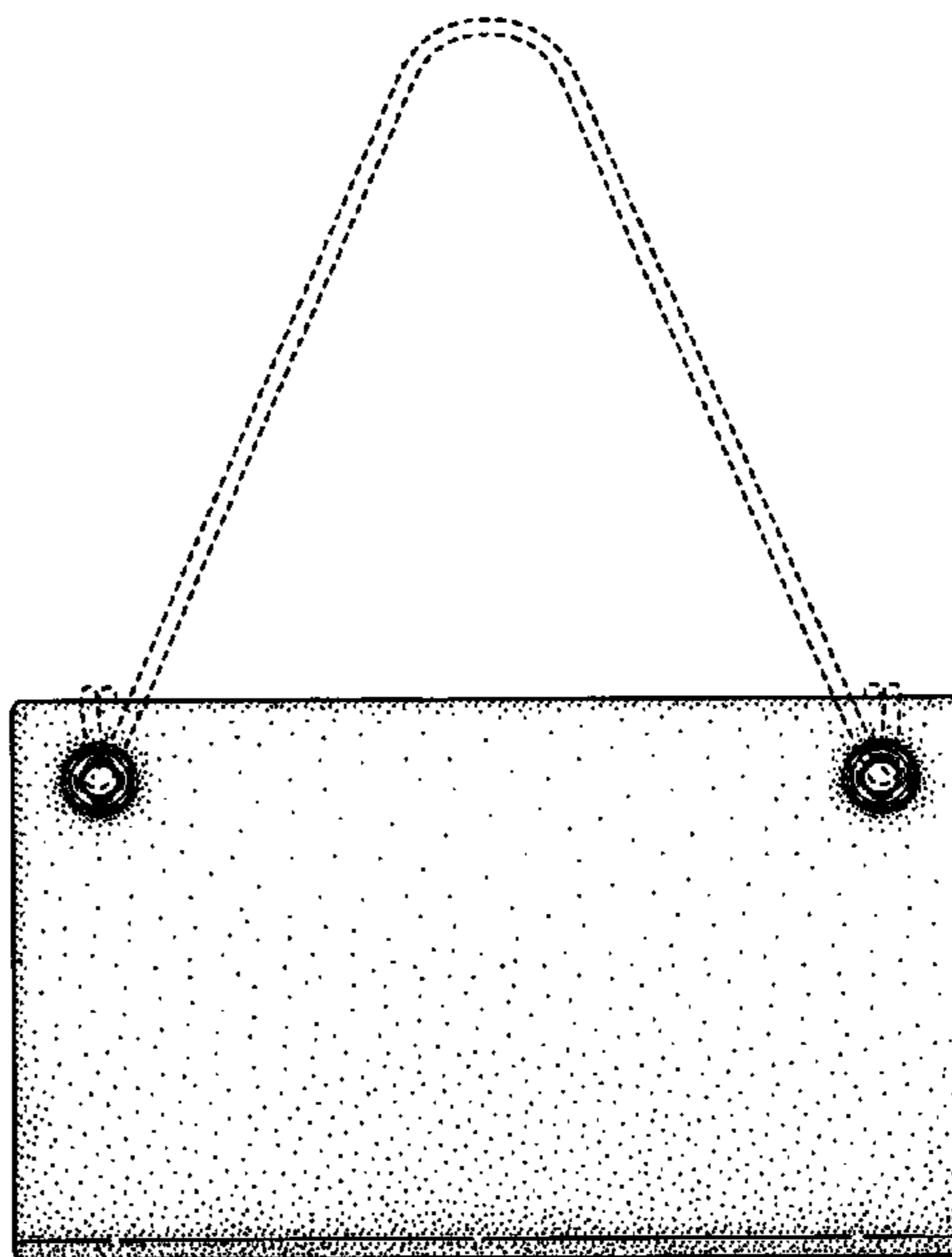
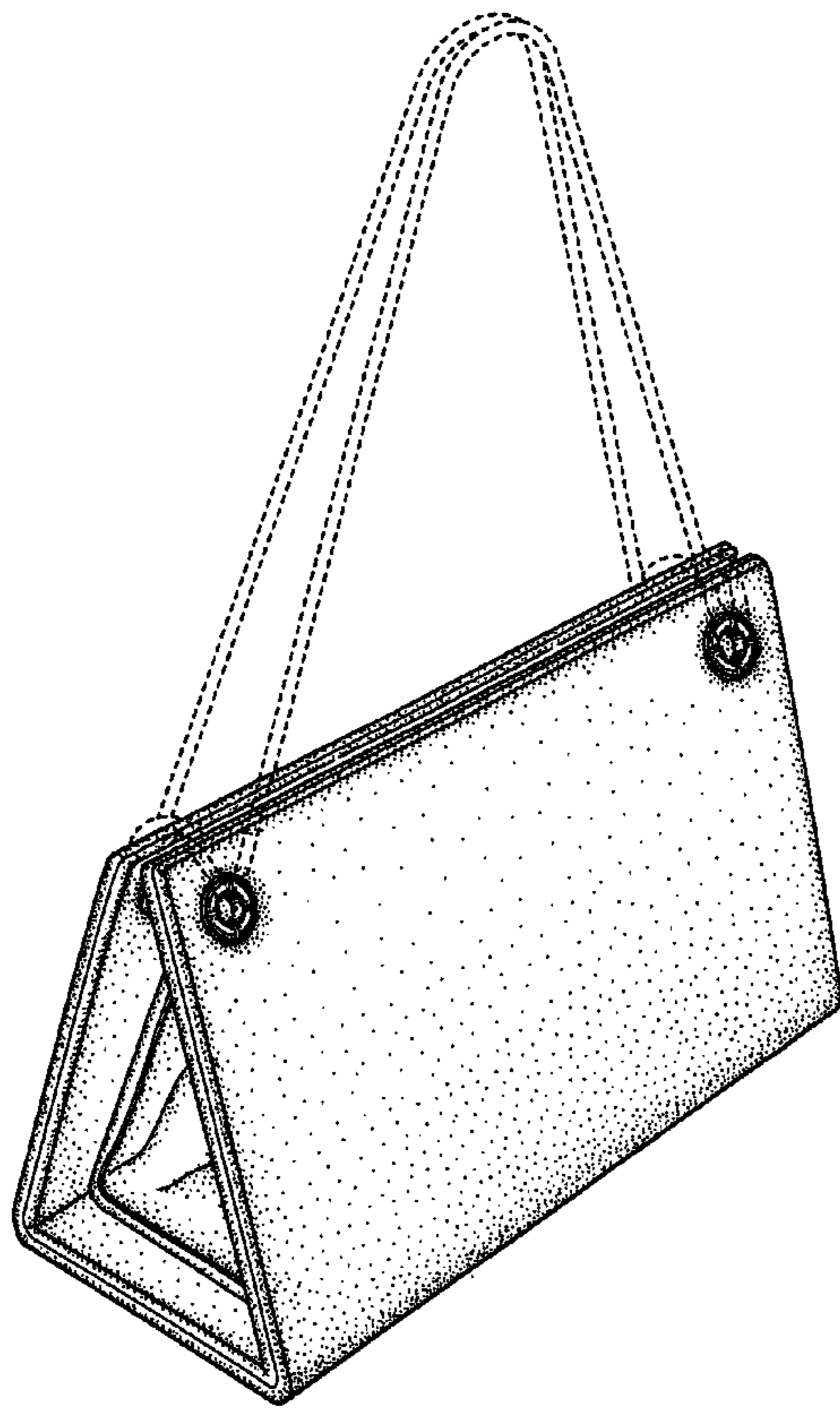

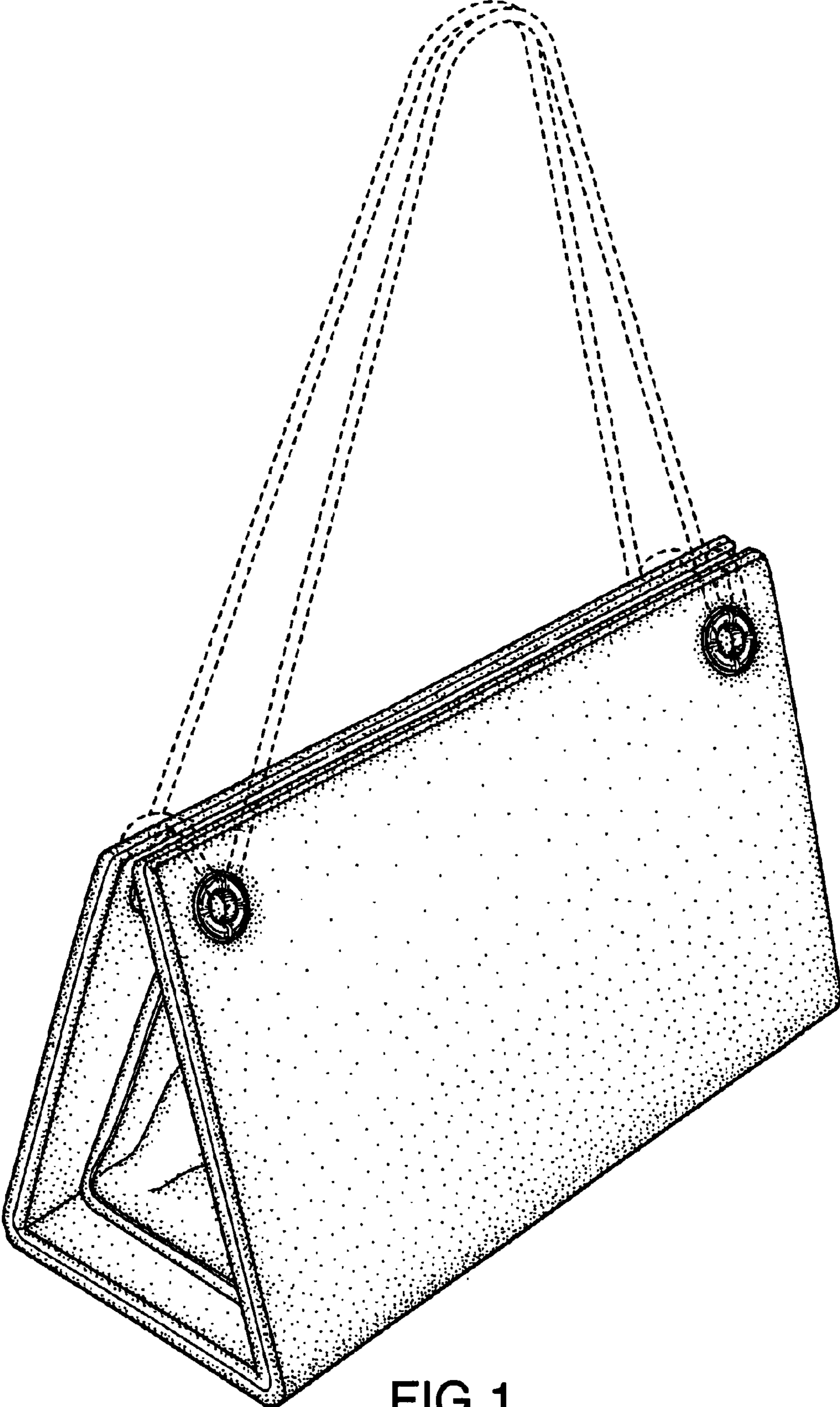

FIG.1

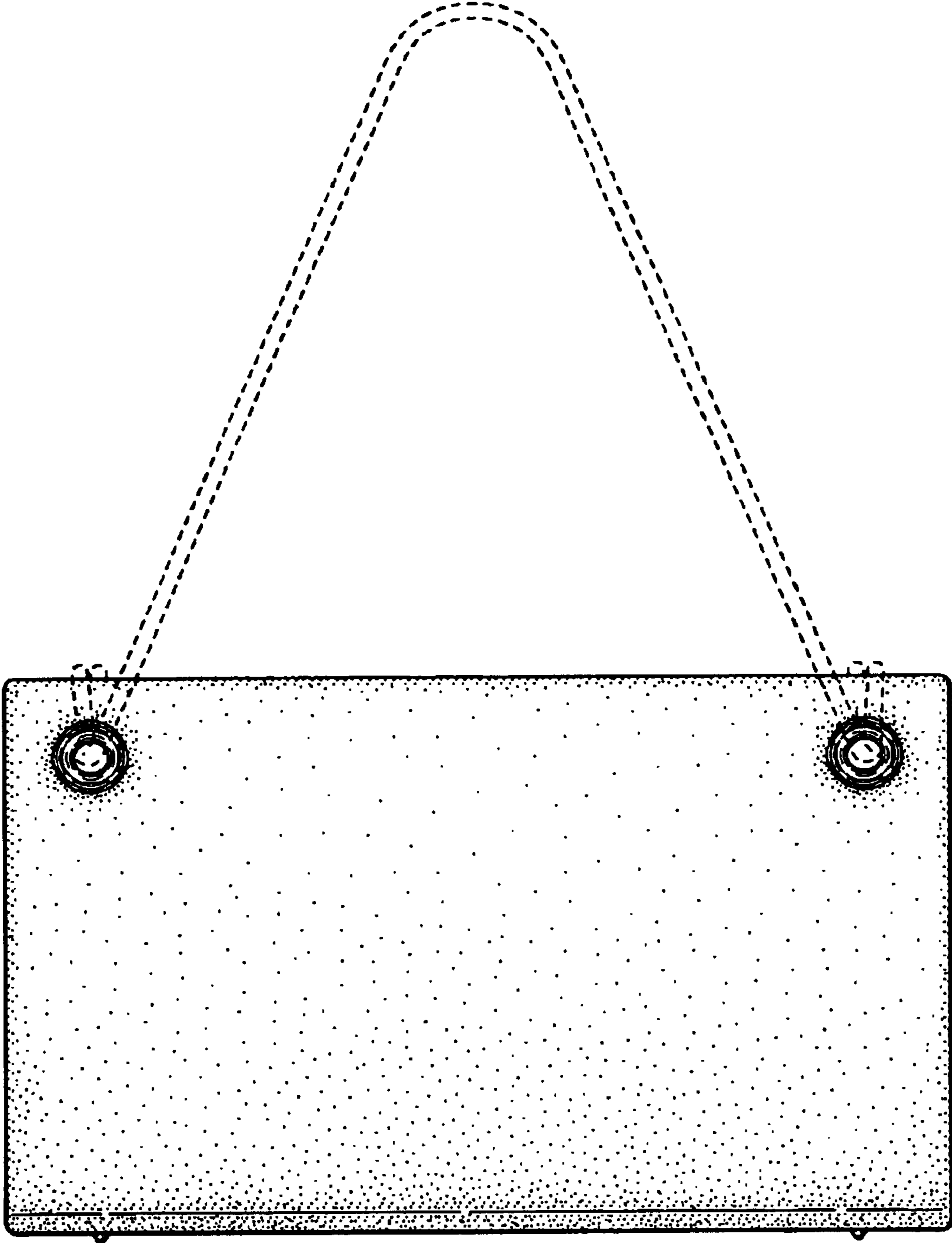

FIG. 2

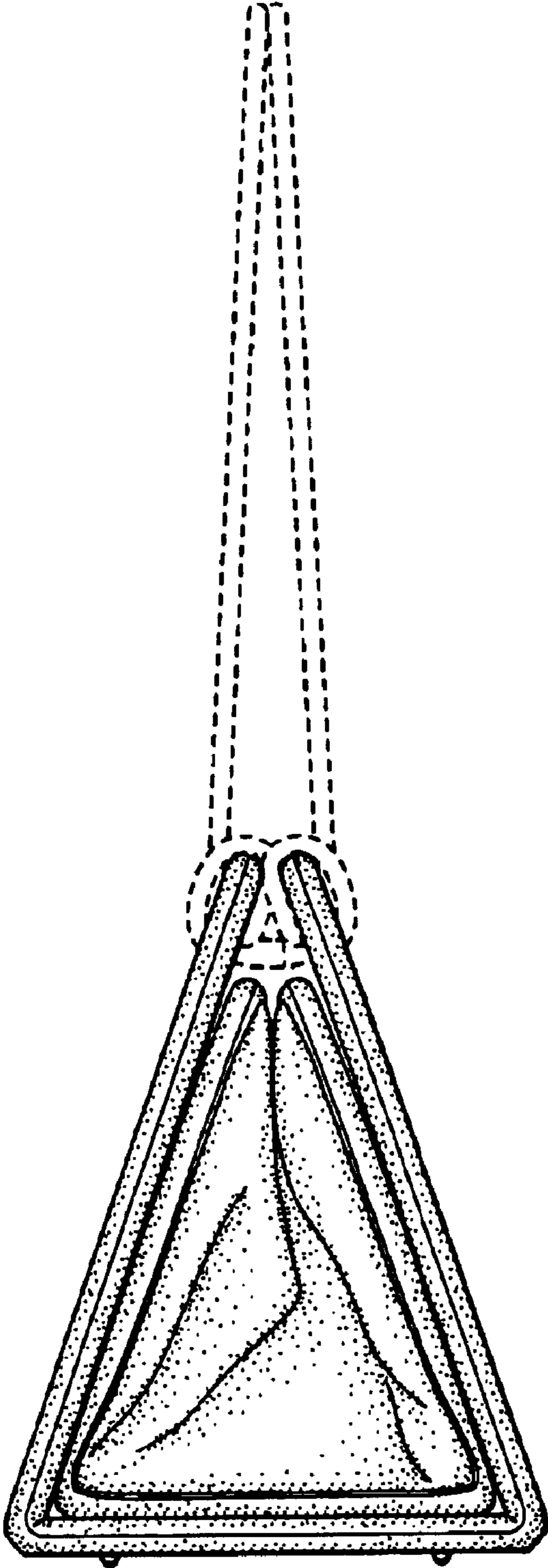

FIG.3

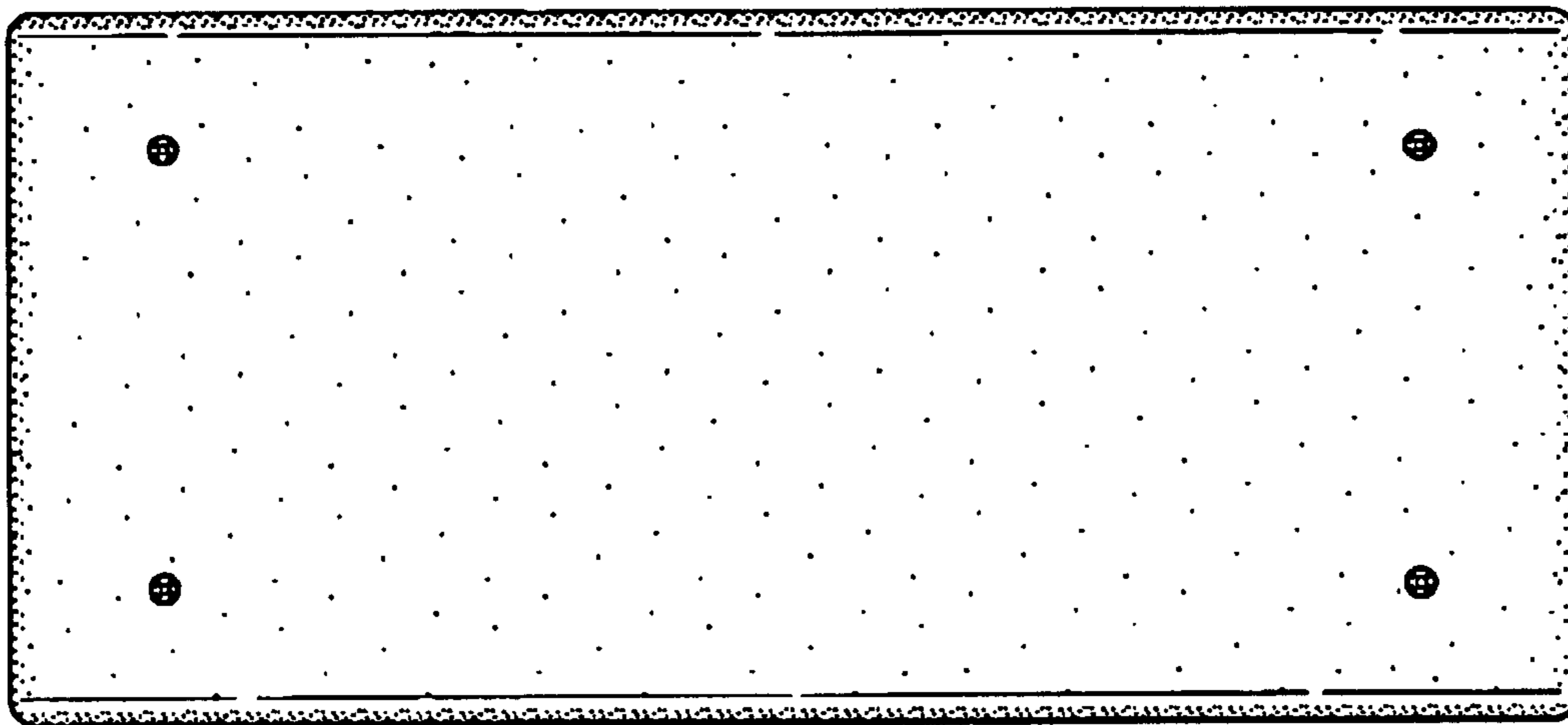

FIG.4

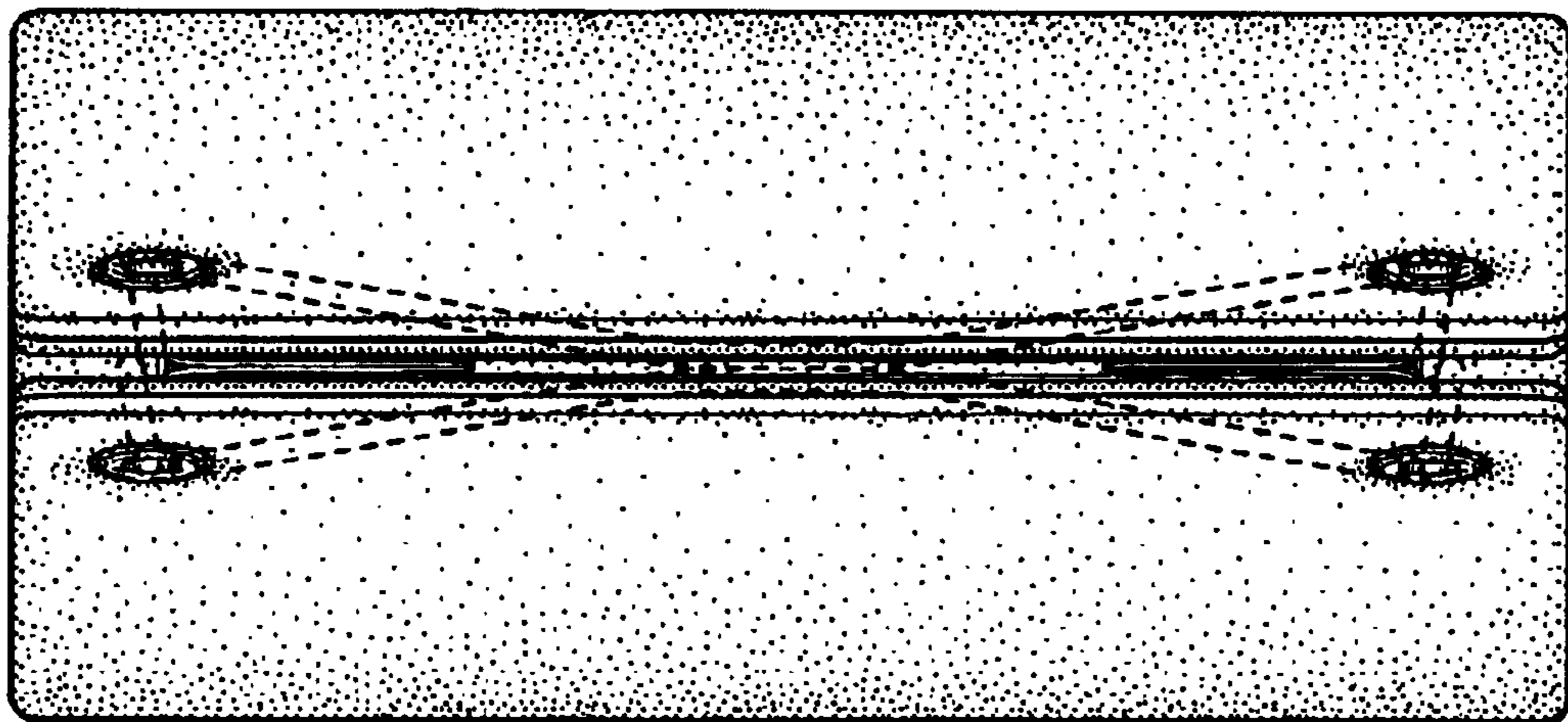

FIG.5

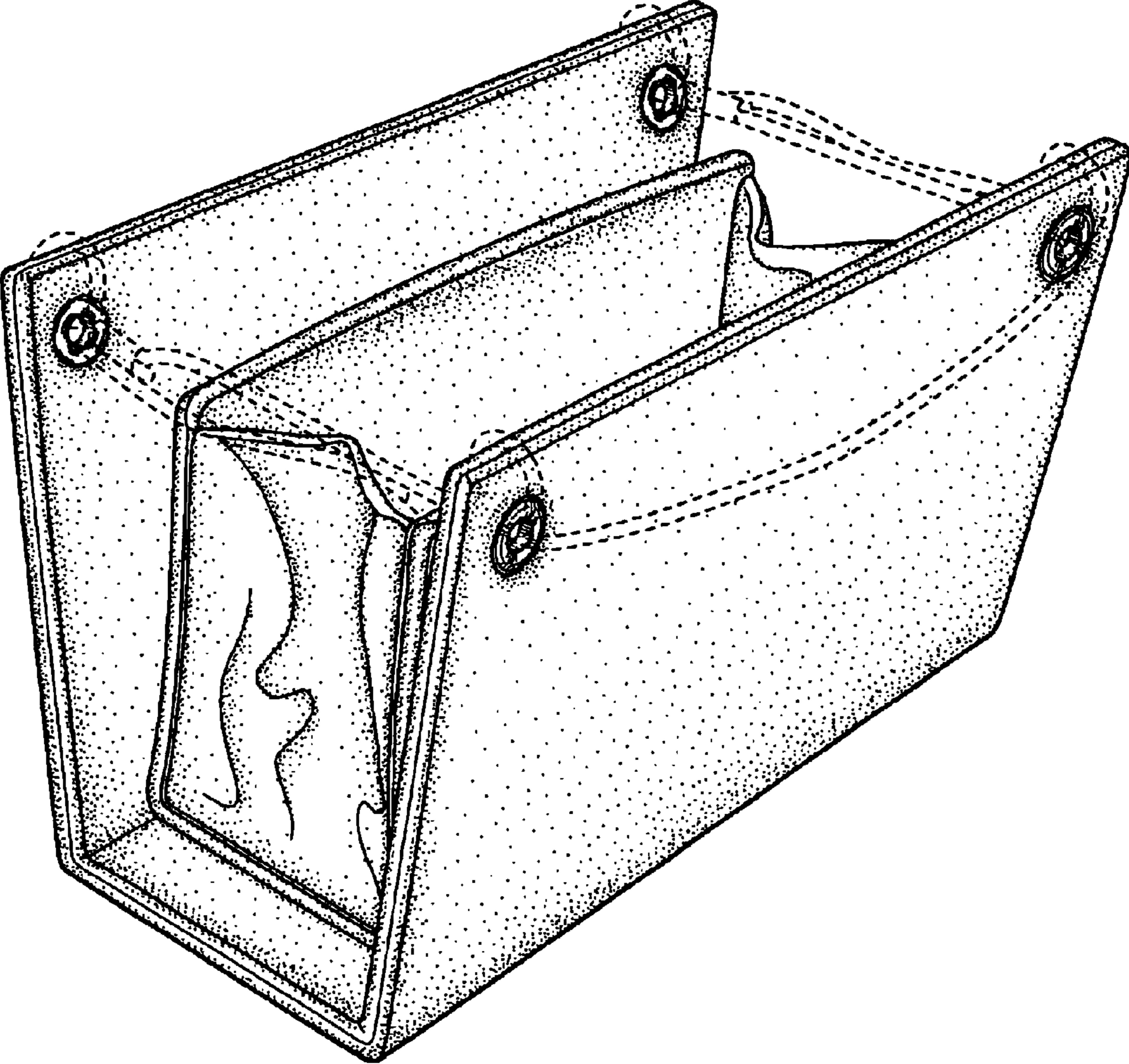

FIG.6