



US00D495727S1

(12) **United States Design Patent**  
**Dow et al.**

(10) **Patent No.:** **US D495,727 S**  
(45) **Date of Patent:** **\*\* Sep. 7, 2004**

(54) **CAMERA**

(75) Inventors: **James C. Dow**, Fort Collins, CO (US);  
**Eduardo Martres**, Greeley, CO (US);  
**Shelley I. Moore**, Fort Collins, CO  
(US); **Lin-Yun Wu**, Toufen (TW)

(73) Assignee: **Hewlett-Packard Development  
Company, L.P.**, Houston, TX (US)

(\*\*) Term: **14 Years**

(21) Appl. No.: **29/193,013**

(22) Filed: **Oct. 31, 2003**

(51) **LOC (7) Cl.** ..... **16-01**

(52) **U.S. Cl.** ..... **D16/202**

(58) **Field of Search** ..... D16/200-204,  
D16/208, 209, 218; 348/373-376; 358/909.1;  
396/535-541

(56) **References Cited**

**U.S. PATENT DOCUMENTS**

5,555,052 A	*	9/1996	Pearson	.....	396/538
D445,440 S	*	7/2001	Chen	.....	D16/202
D475,384 S	*	6/2003	Tanaka	.....	D16/202
D481,405 S	*	10/2003	Sakaguchi	.....	D16/202
D482,053 S	*	11/2003	Ip et al.	.....	D16/202
D482,054 S	*	11/2003	Nasu	.....	D16/202

D487,283 S \* 3/2004 Watanabe ..... D16/202

\* cited by examiner

*Primary Examiner*—Adir Aronovich

(57) **CLAIM**

The ornamental design for a camera, as shown and described.

**DESCRIPTION**

FIG. 1 is a perspective view of camera showing the front, left, and top sides of our design;  
FIG. 2 is an elevation view showing the front side of our design;  
FIG. 3 is an elevation view showing the right side of our design;  
FIG. 4 is an elevation view showing the left side of our design;  
FIG. 5 is an elevation view showing the rear side of our design;  
FIG. 6 is a plan view showing the top side of our design; and,  
FIG. 7 is a plan view showing the bottom side of our design.  
It should be understood that the labels used herein for describing orientation (e.g., front, rear, top, bottom, right and left) are merely for reference, and the design may be disposed in any manner and still be within the scope of the present invention.

**1 Claim, 3 Drawing Sheets**

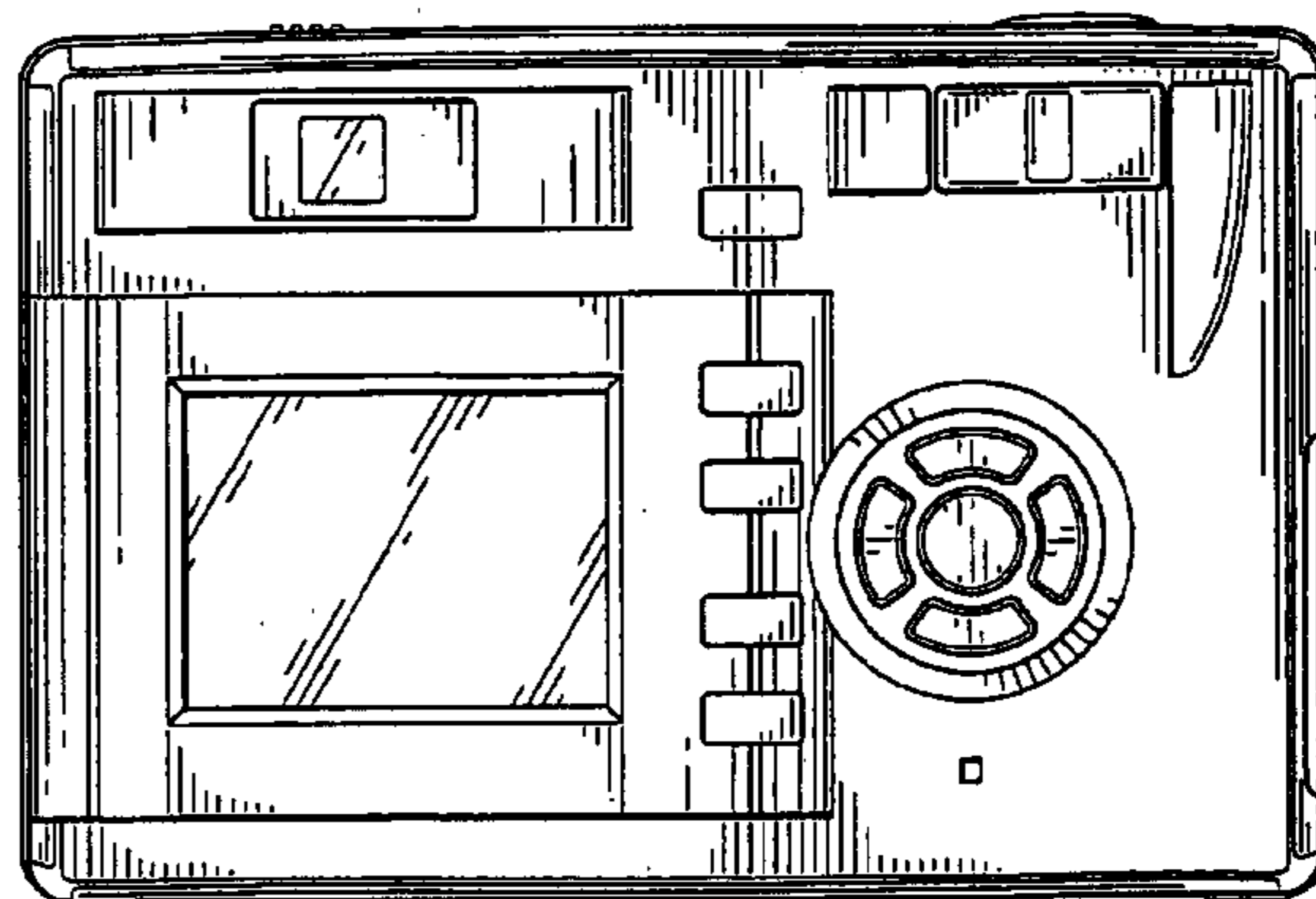
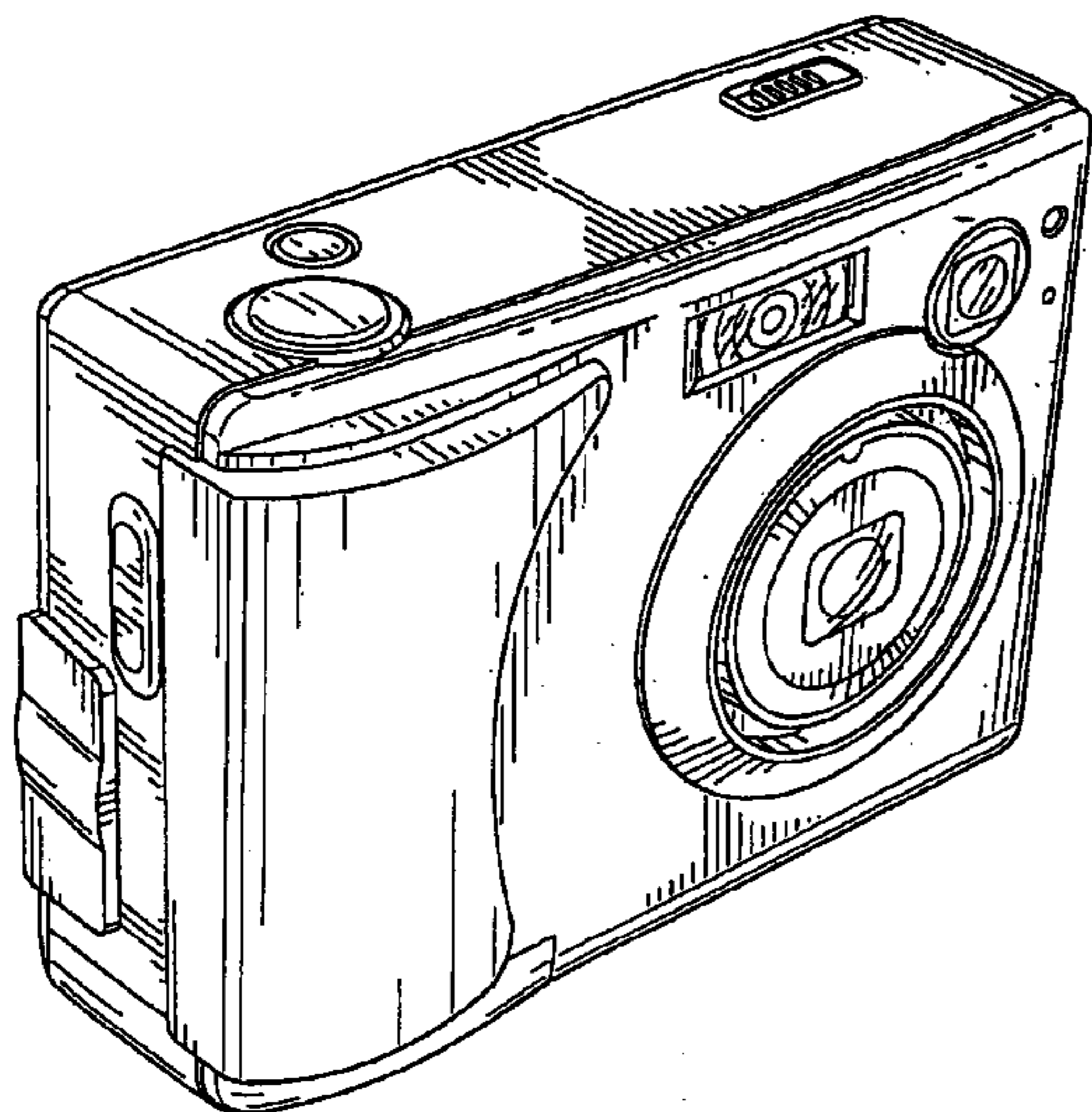

FIG. 1

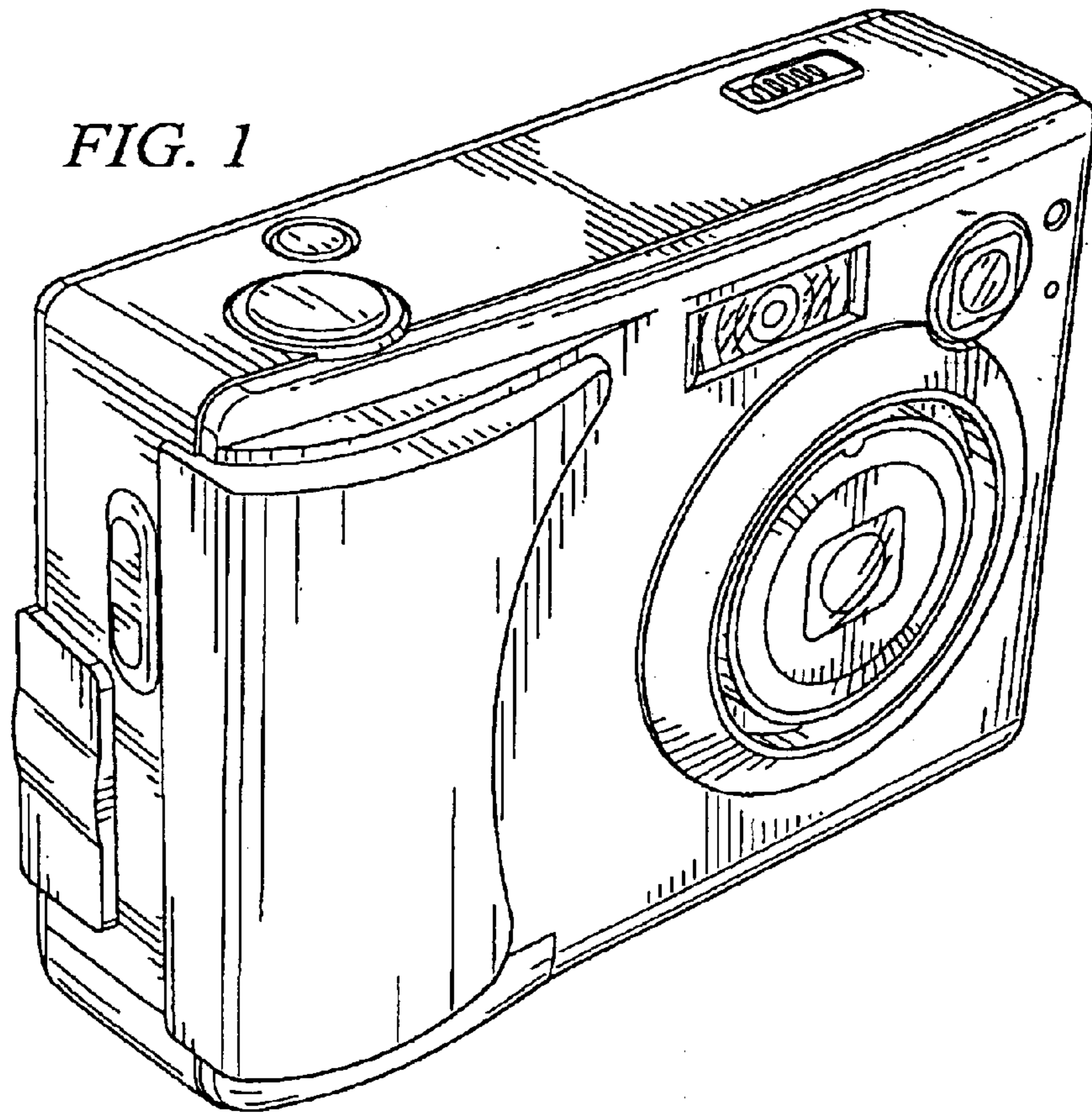

FIG. 2

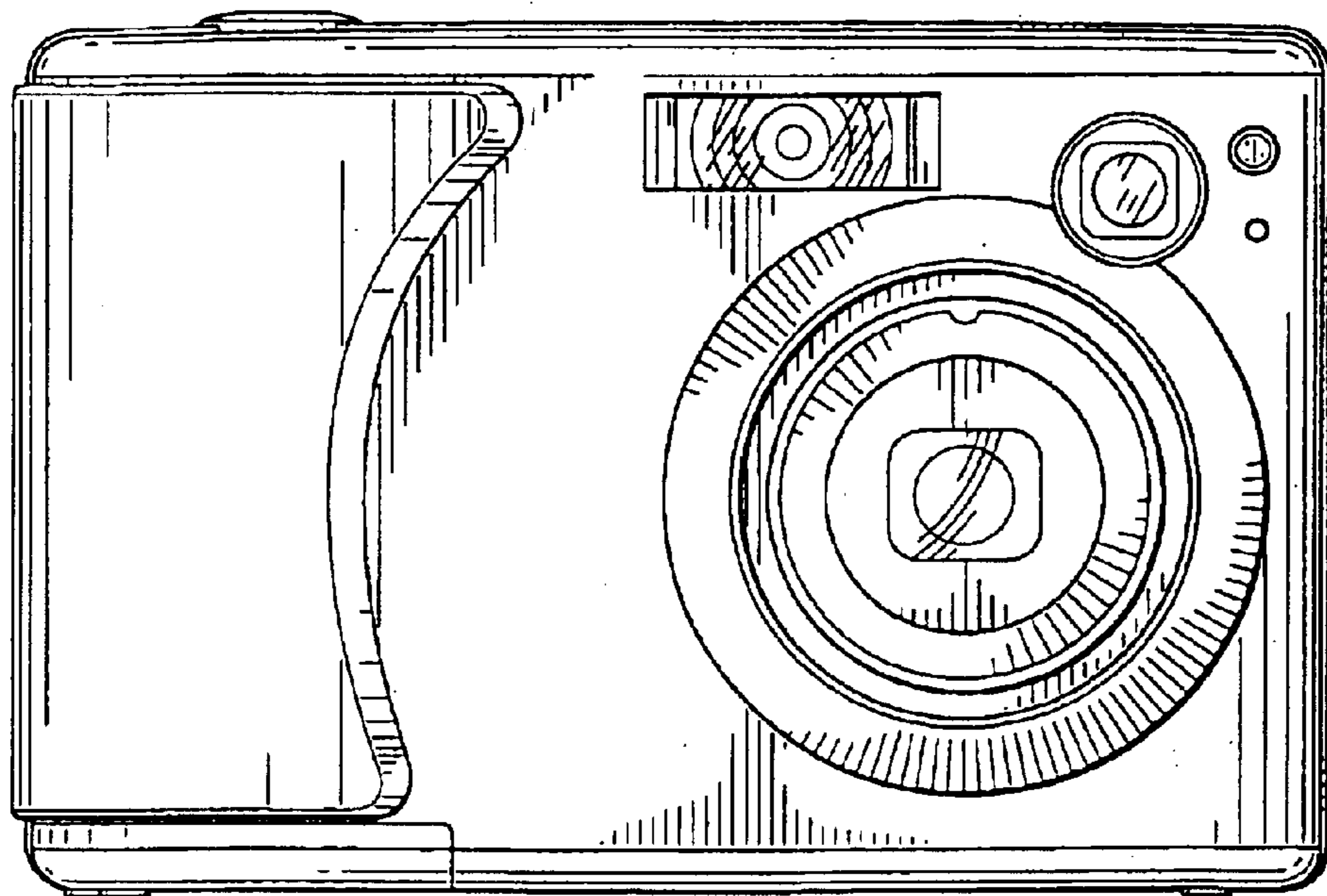

FIG. 3

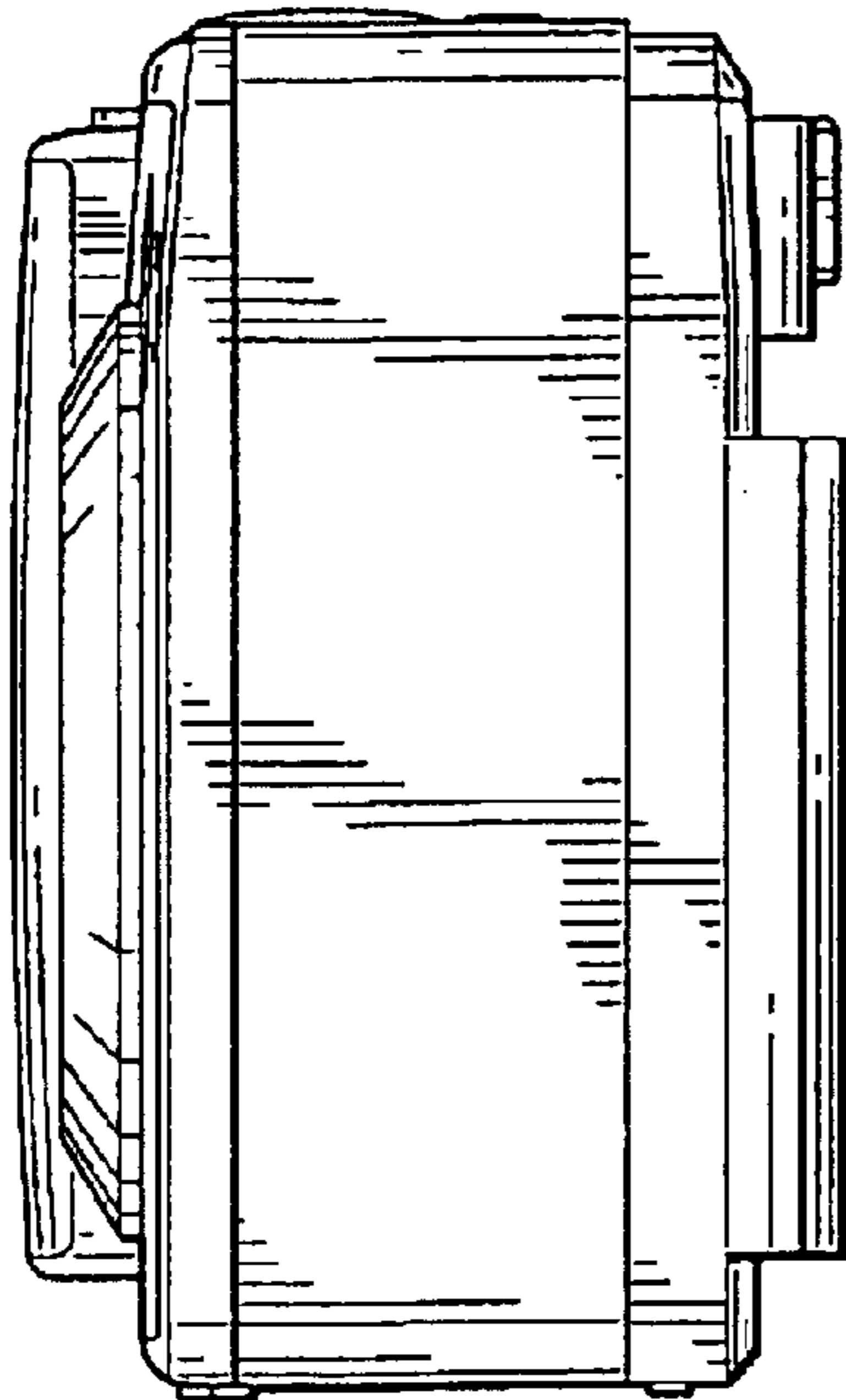

FIG. 4

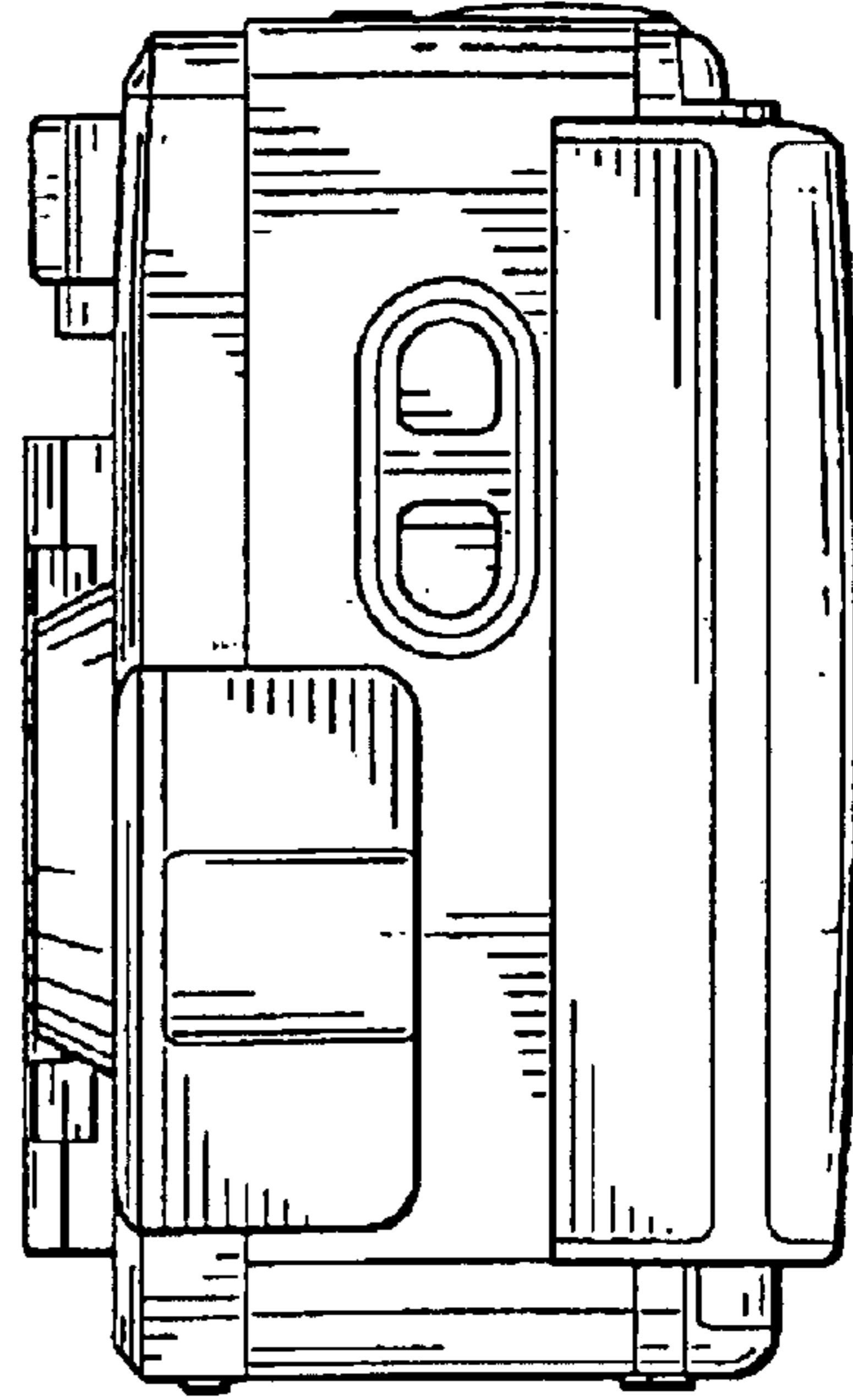

FIG. 5

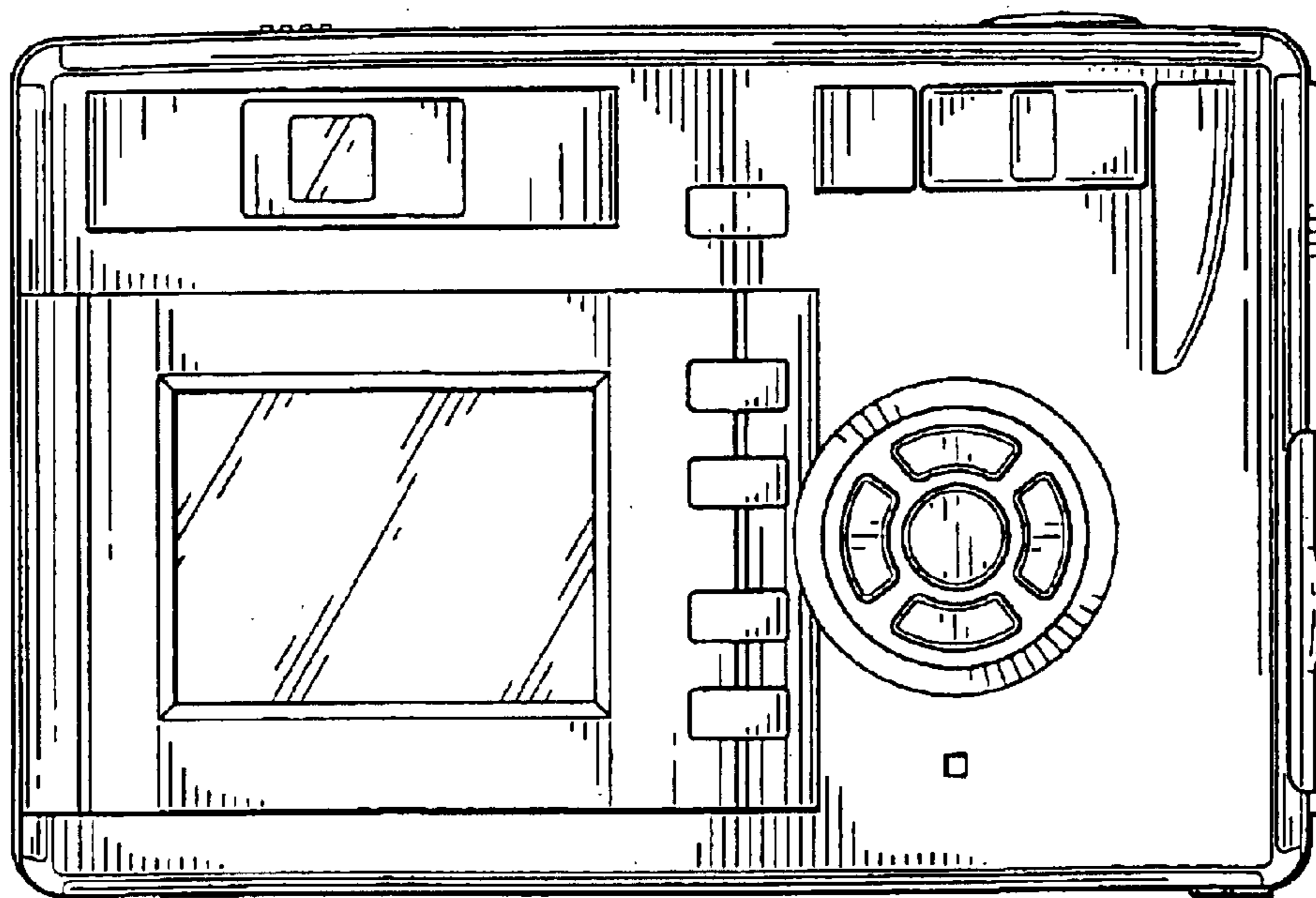



FIG. 6

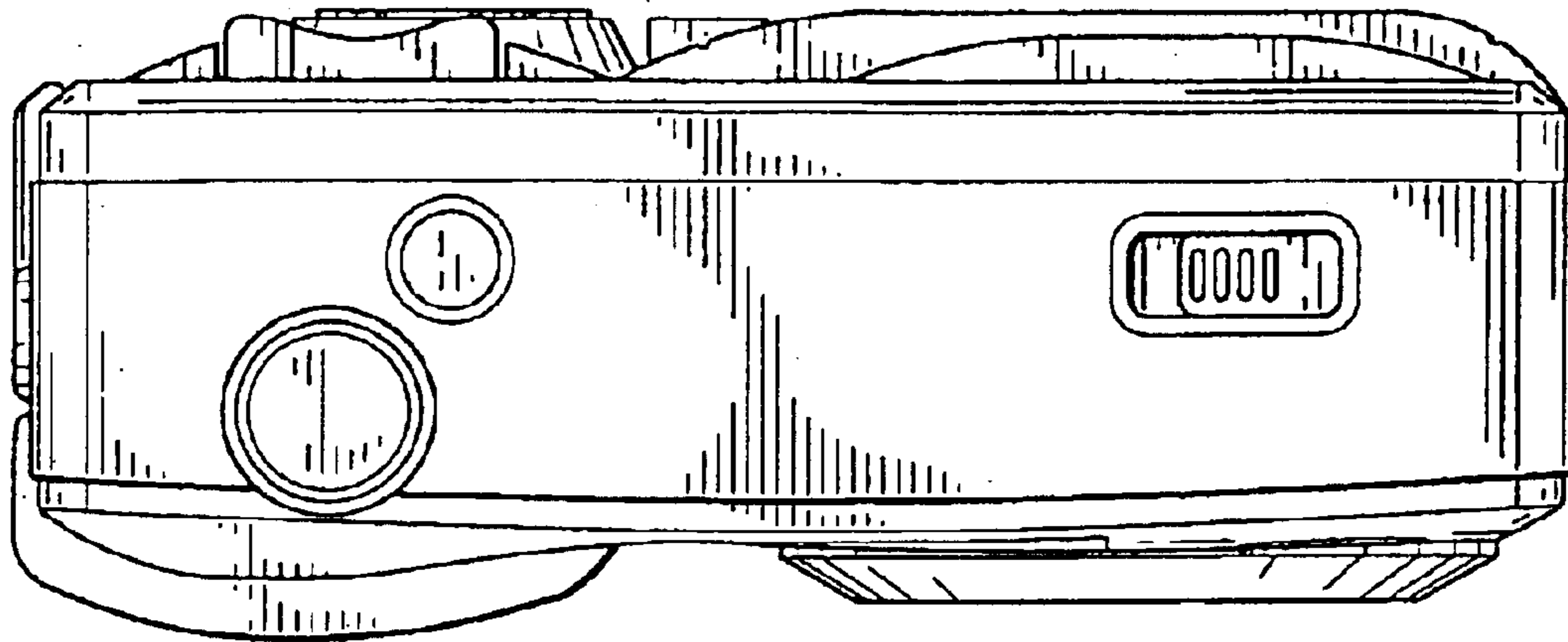

FIG. 7

