

US00D495622S1

(12) **United States Design Patent**  
**Uehara**

(10) **Patent No.:** **US D495,622 S**  
(45) **Date of Patent:** **\*\* Sep. 7, 2004**

(54) **BUCKLE**

(75) **Inventor:** **Ryoichiro Uehara, Tokyo (JP)**

(73) **Assignee:** **YKK Corporation (JP)**

(\*\*) **Term:** **14 Years**

(21) **Appl. No.:** **29/181,650**

(22) **Filed:** **May 15, 2003**

(30) **Foreign Application Priority Data**

Nov. 15, 2002 (JP) ..... 2002-031472  
Nov. 15, 2002 (JP) ..... 2002-031473

(51) **LOC (7) Cl.** ..... **02-07**

(52) **U.S. Cl.** ..... **D11/216**

(58) **Field of Search** ..... D11/1-2, 26-29,  
D11/89-92; 63/26-28, 32

(56) **References Cited**

**U.S. PATENT DOCUMENTS**

D379,161 S \* 5/1997 Matoba ..... D11/216  
D467,521 S \* 12/2002 Yoshiguchi ..... D11/216  
D475,654 S \* 6/2003 Yoshiguchi ..... D11/216

\* cited by examiner

*Primary Examiner*—Ralf Seifert

(74) *Attorney, Agent, or Firm*—Finnegan, Henderson,  
Farabow, Garrett & Dunner, L.L.P.

(57) **CLAIM**

The ornamental design for a buckle, as shown and described.

**DESCRIPTION**

FIG. 1 is a perspective view of the buckle showing a first embodiment of my new design;

FIG. 2 is a front-elevational view of the embodiment of FIG. 1;

FIG. 3 is a rear view of the embodiment of FIG. 1;

FIG. 4 is a top-plan view of the embodiment of FIG. 1;

FIG. 5 is a bottom-plan view of the embodiment of FIG. 1;

FIG. 6 is a right-side view of the embodiment of FIG. 1, the left side view being a mirror image thereof;

FIG. 7 is a cross-sectional view of the embodiment of FIG. 1 taken along the line 7—7 in FIG. 2;

FIG. 8 is a front view of a male member of the embodiment of FIG. 1;

FIG. 9 is a rear view of the male member of FIG. 8;

FIG. 10 is a right-side view of the male member of FIG. 8, the left-side view being a mirror image thereof;

FIG. 11 is a top-plan view of the male member of FIG. 8;

FIG. 12 is a bottom-plan view of the male member of FIG. 8.

FIG. 13 is a front-elevational view of a female member of the embodiment of FIG. 1;

FIG. 14 is a rear view of the female member of FIG. 13;

FIG. 15 is a right-side view of the female member of FIG. 13, the left-side view being a mirror image thereof;

FIG. 16 is a top-plan view of the female member of FIG. 13; and,

FIG. 17 is a bottom-plan view of the female member of FIG. 13.

**1 Claim, 3 Drawing Sheets**

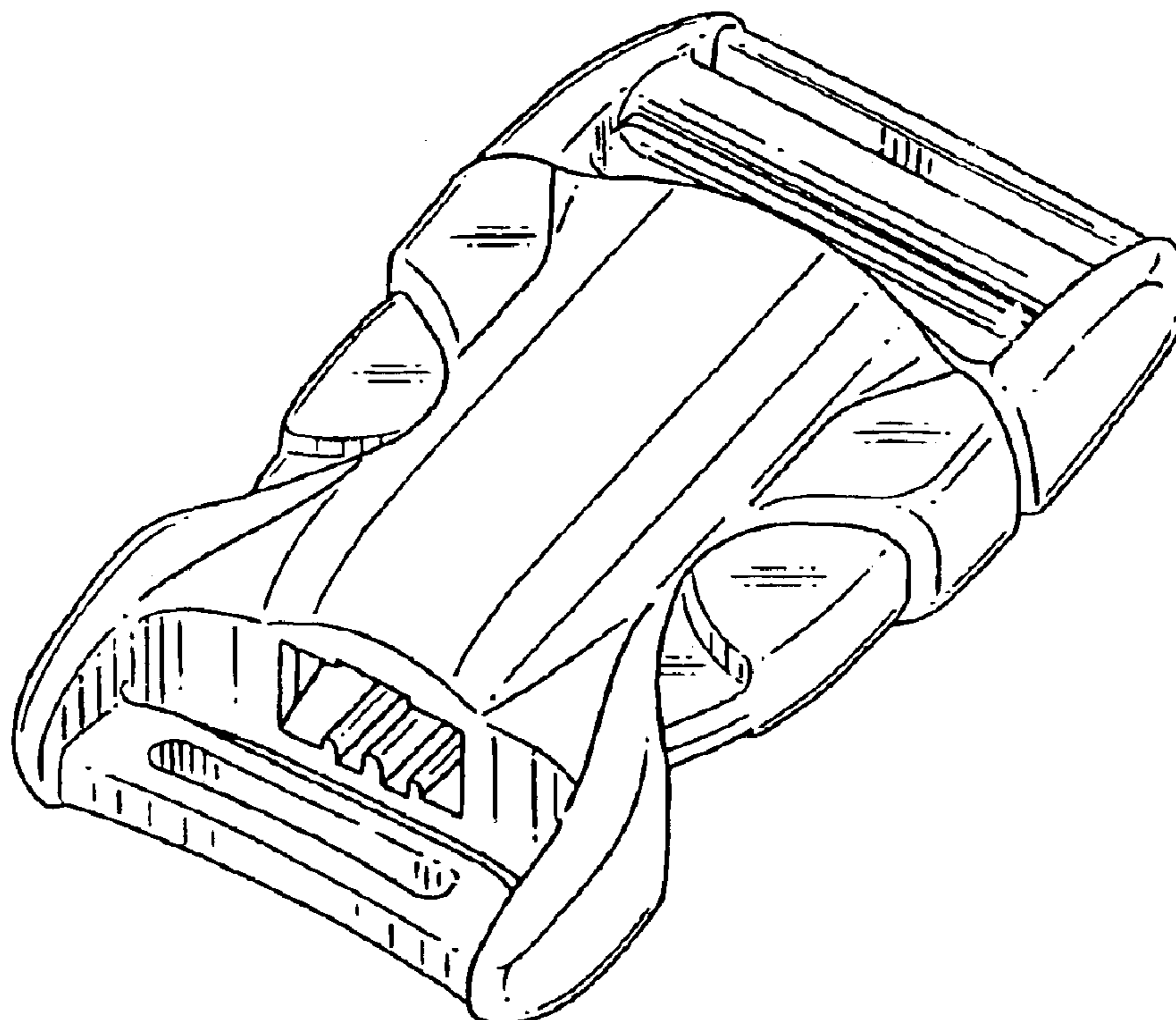

FIG. 1

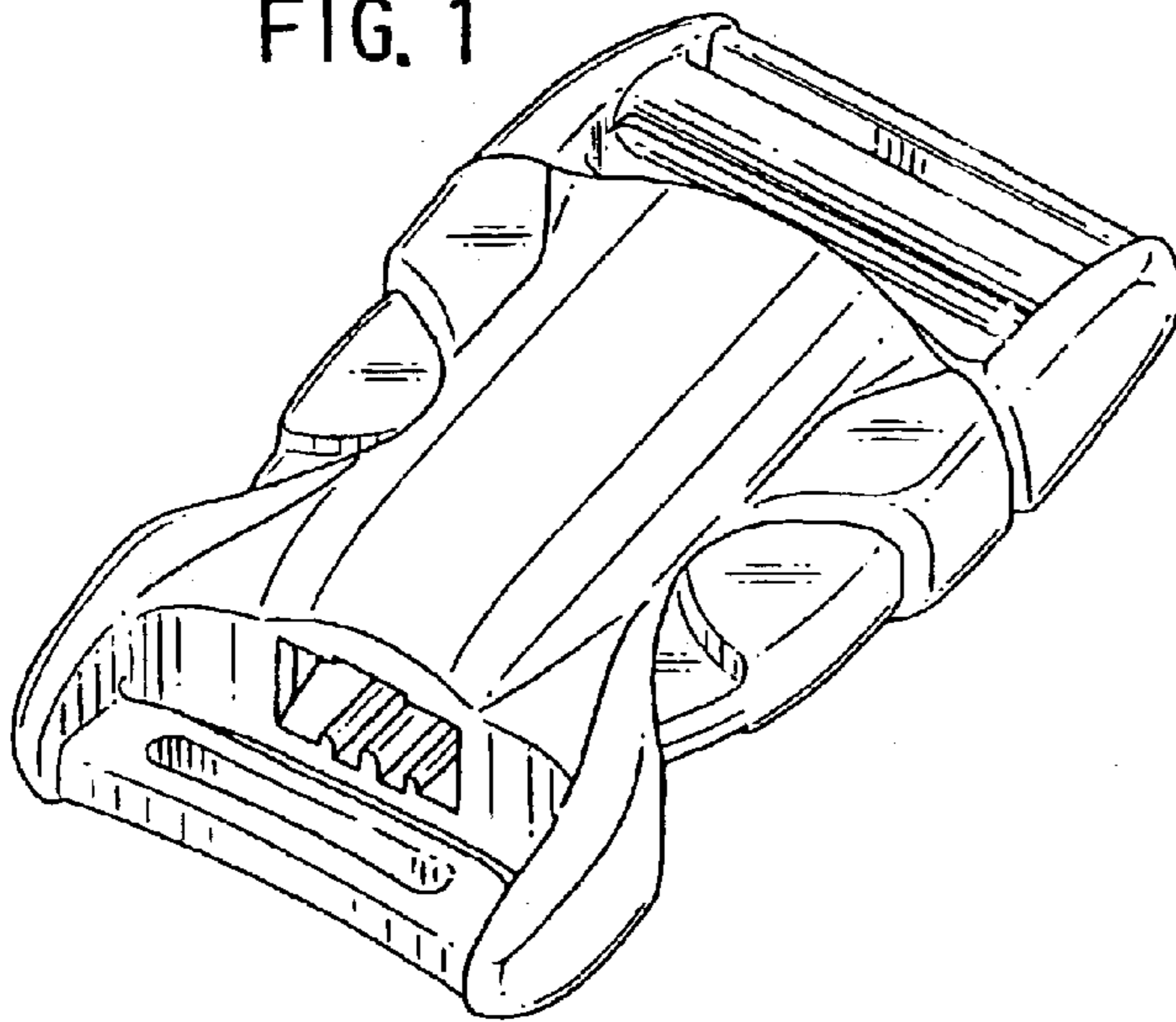

FIG. 6

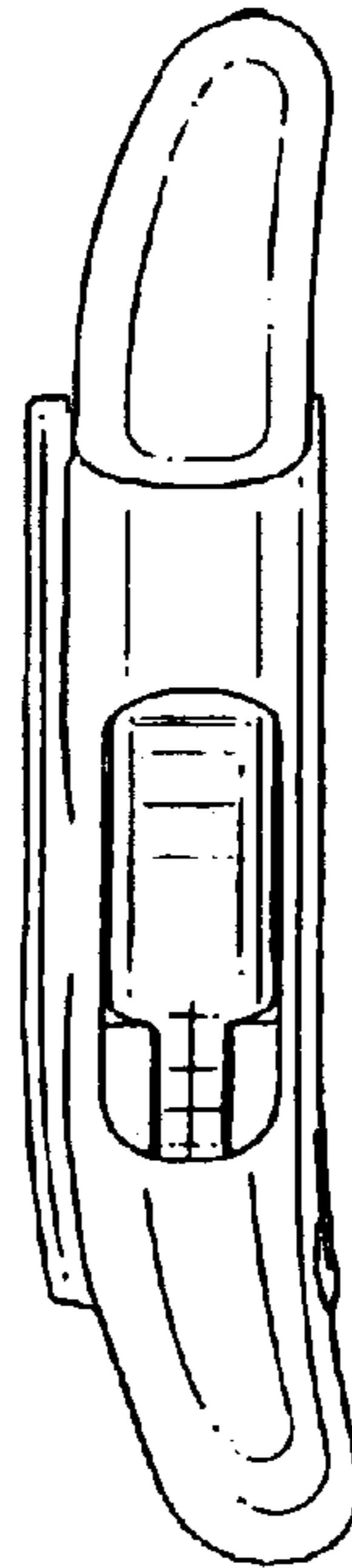

FIG. 7

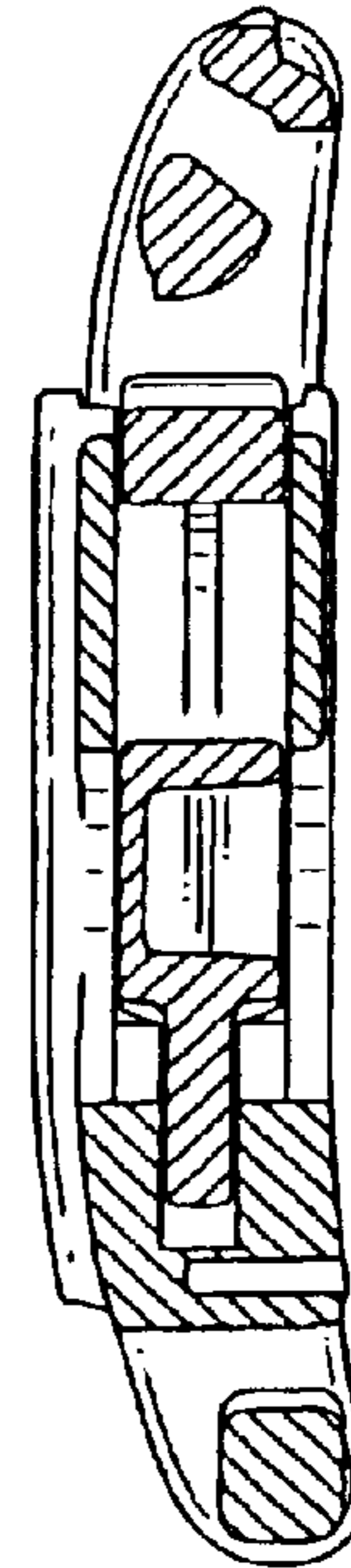

FIG. 2

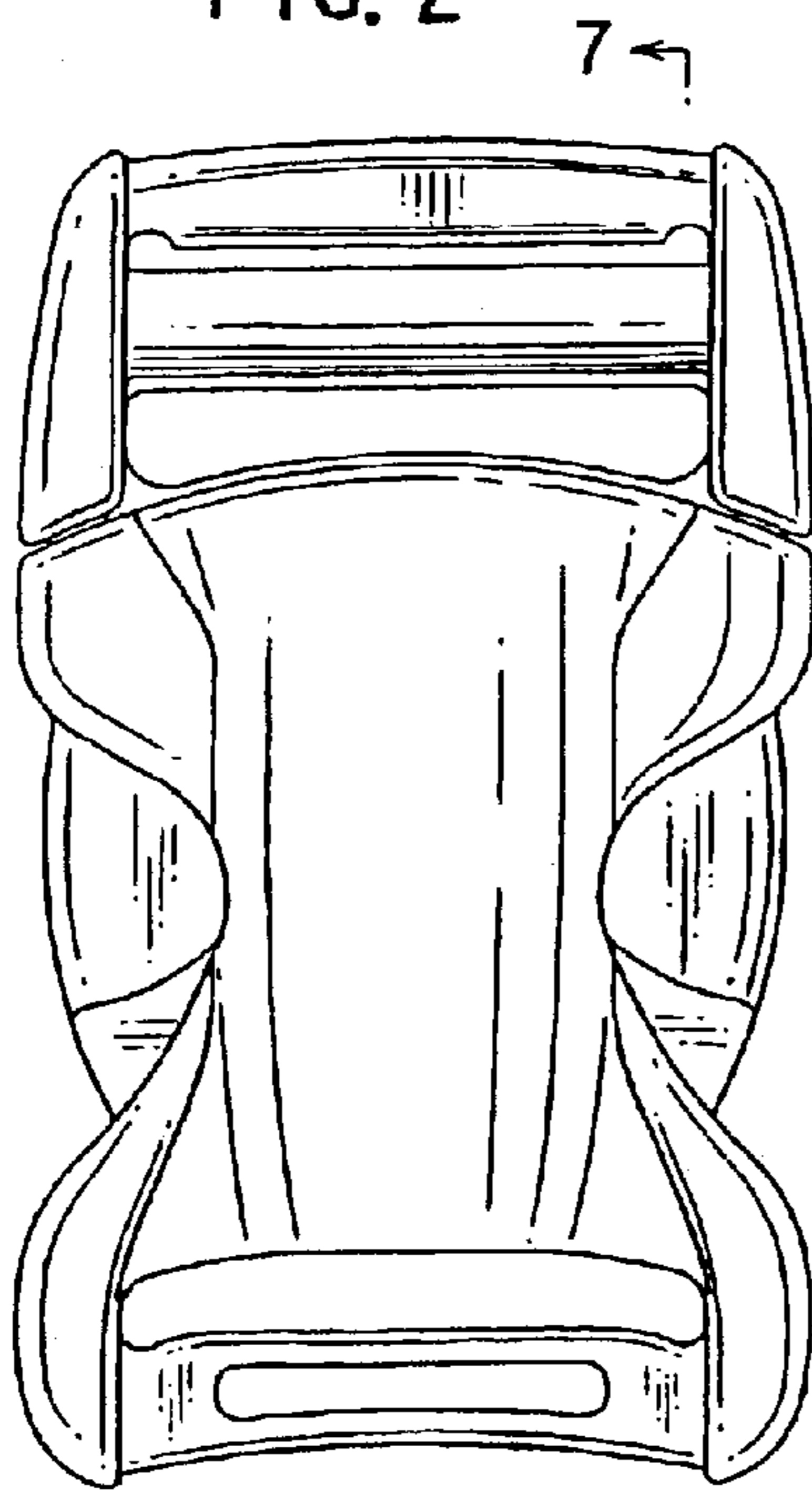

FIG. 3

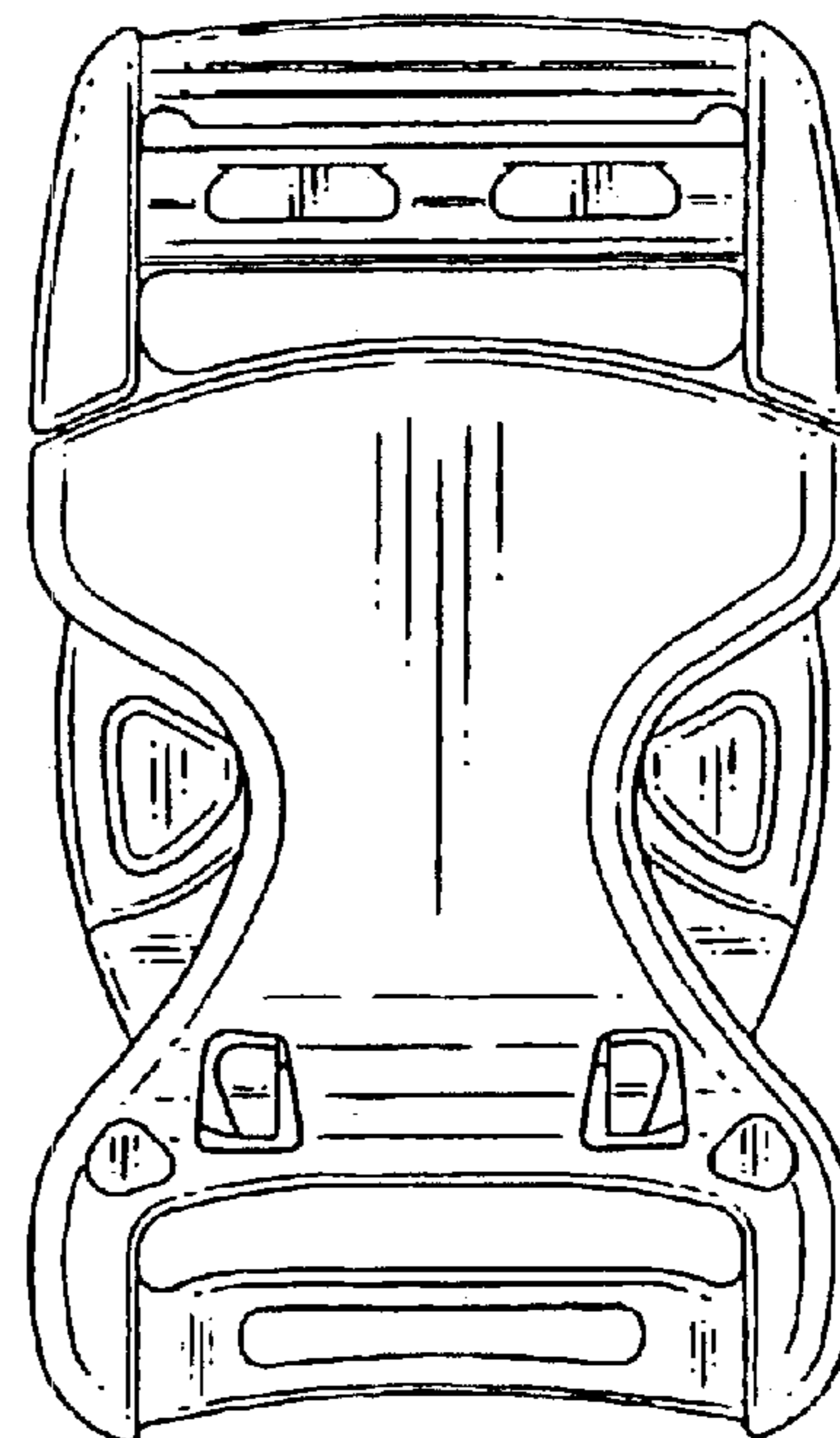

FIG. 4

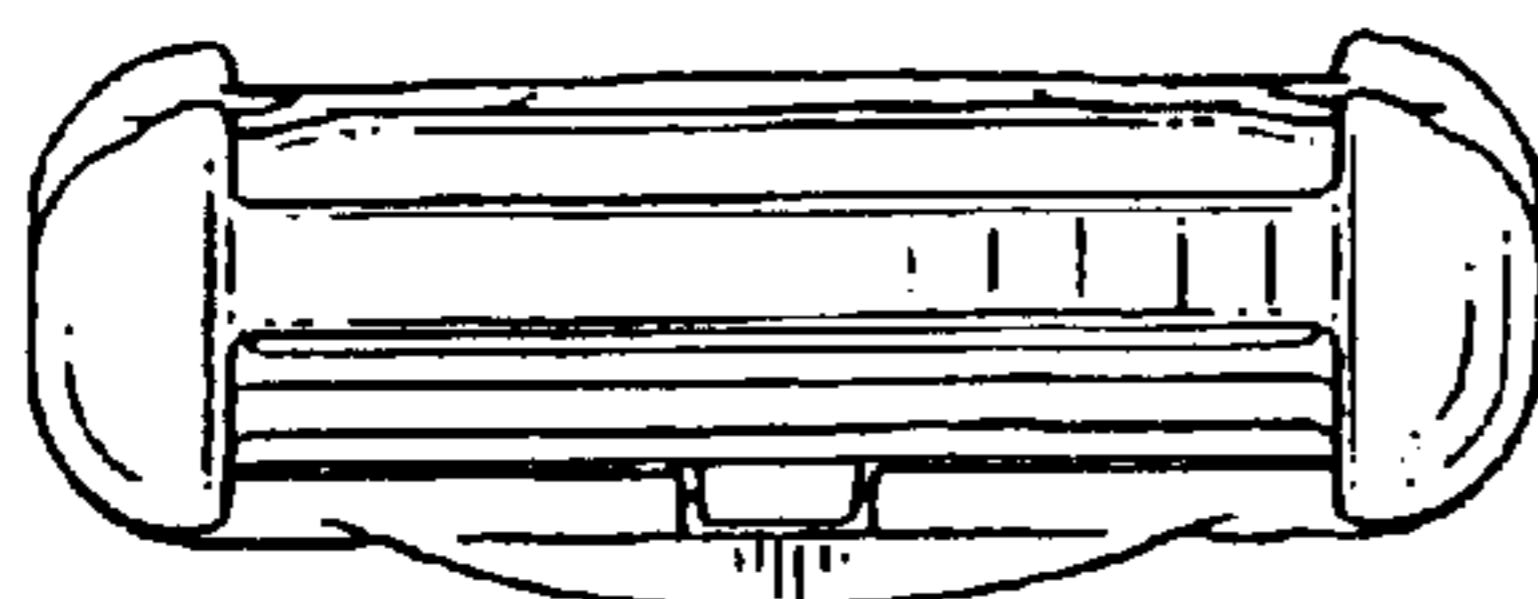

FIG. 5

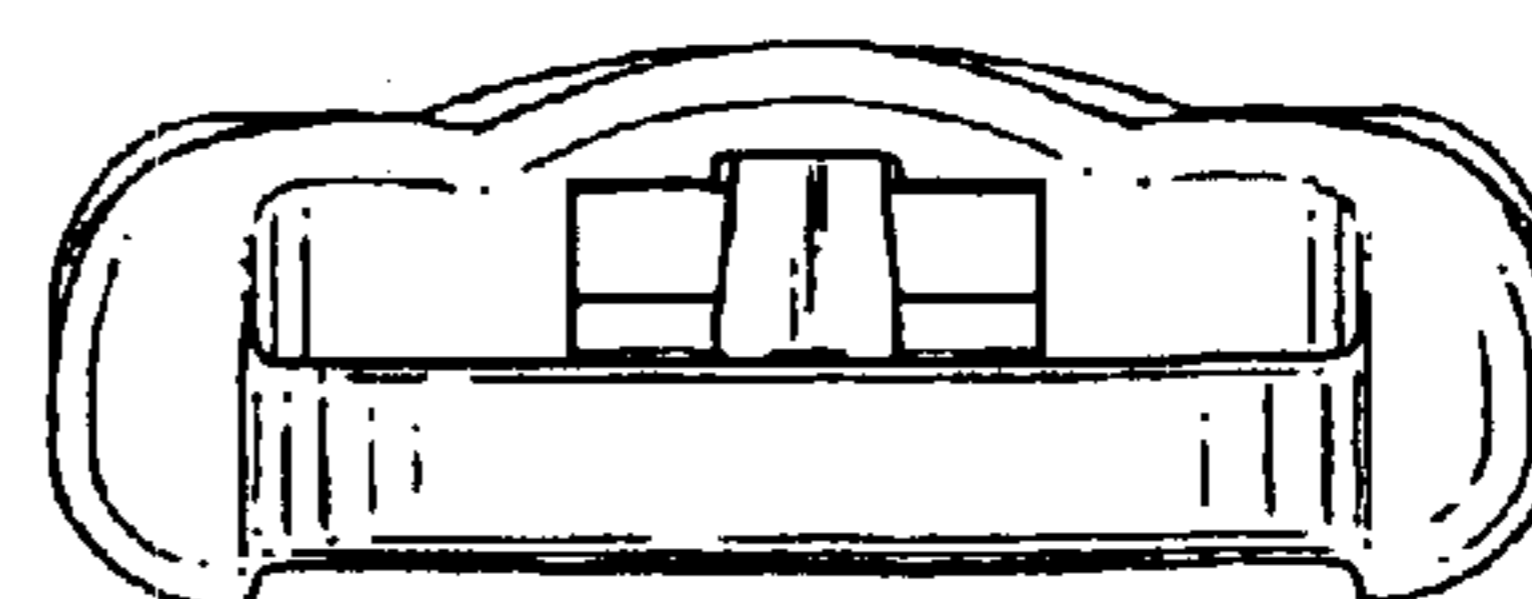

FIG. 8

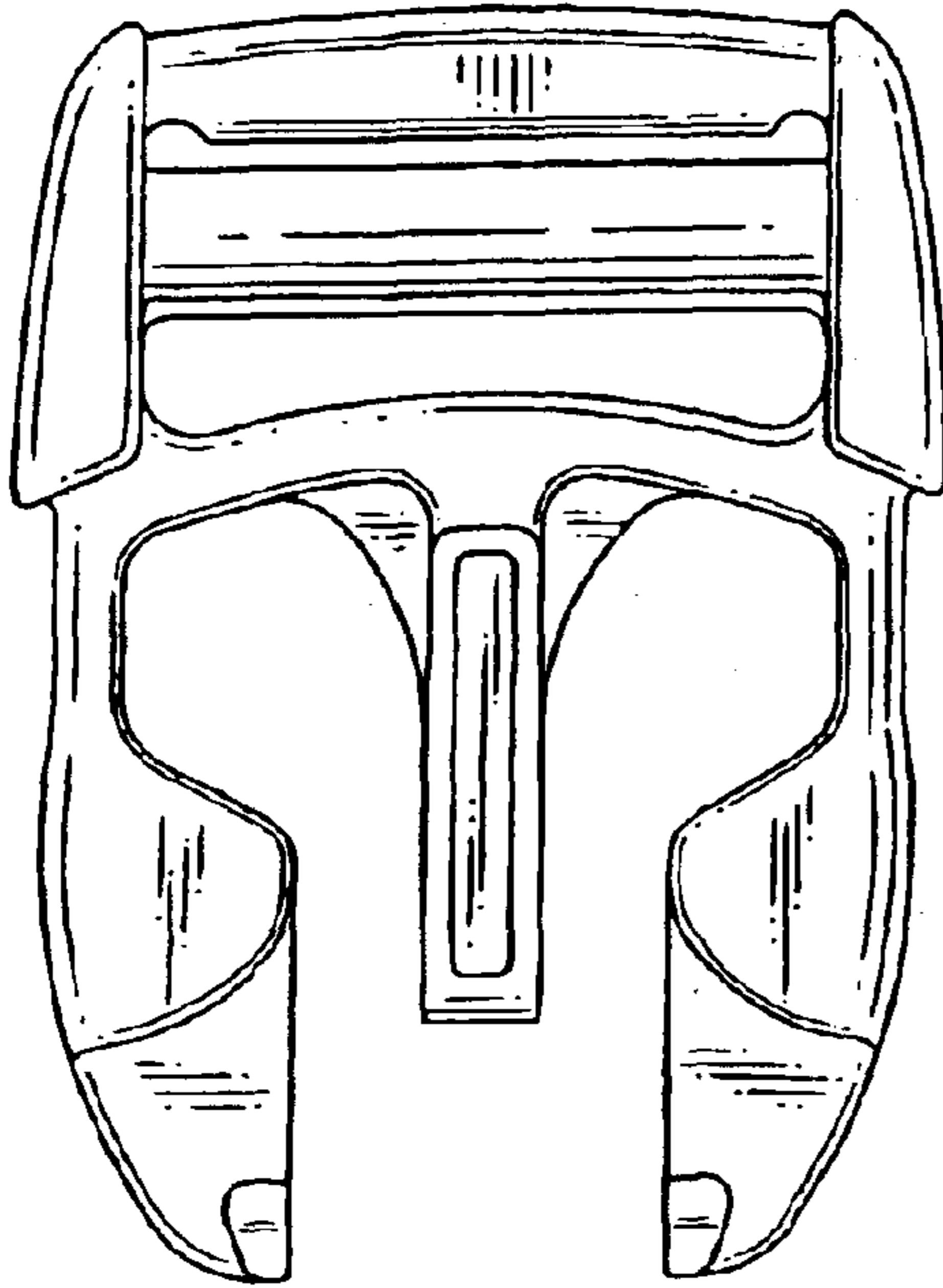

FIG. 9

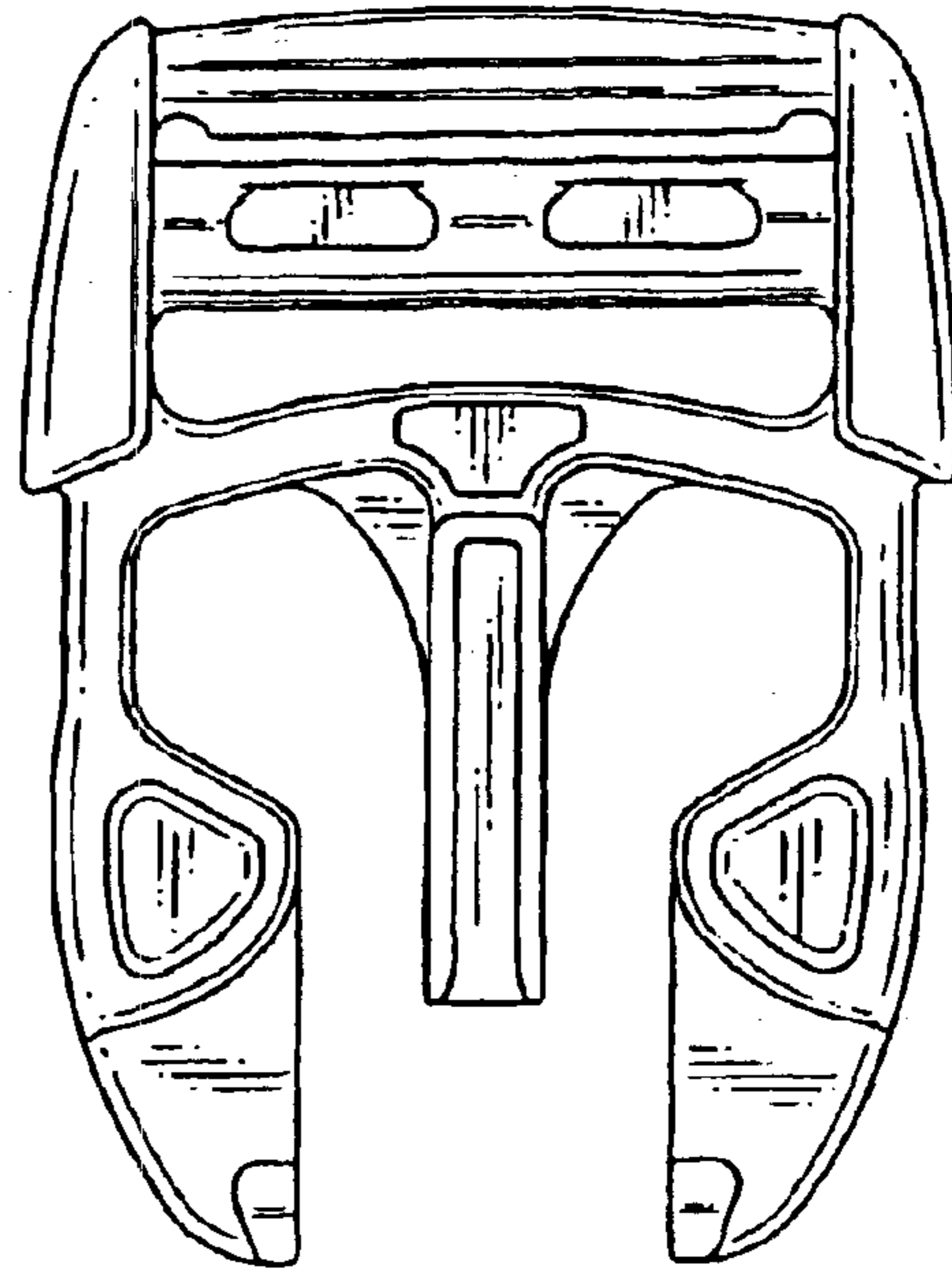

FIG. 10

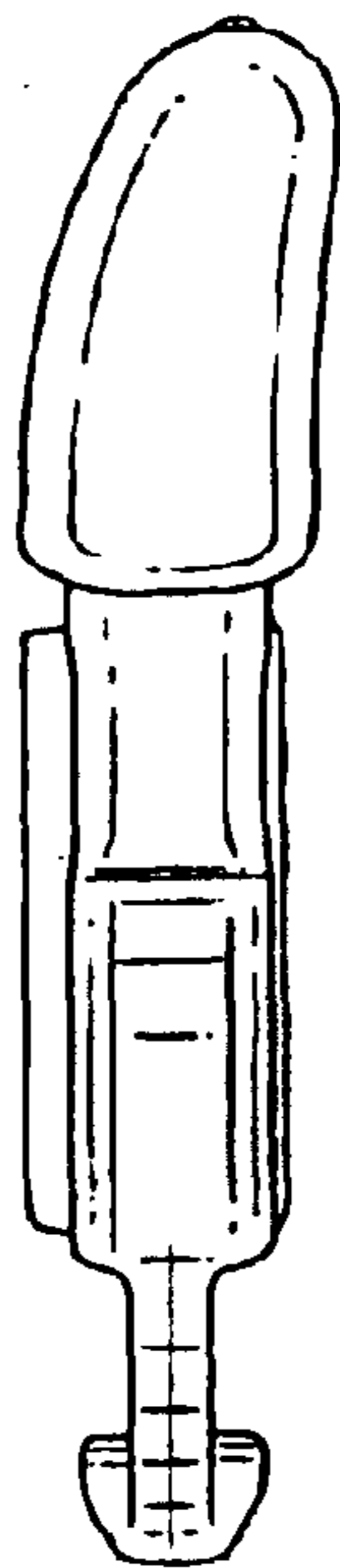

FIG. 11

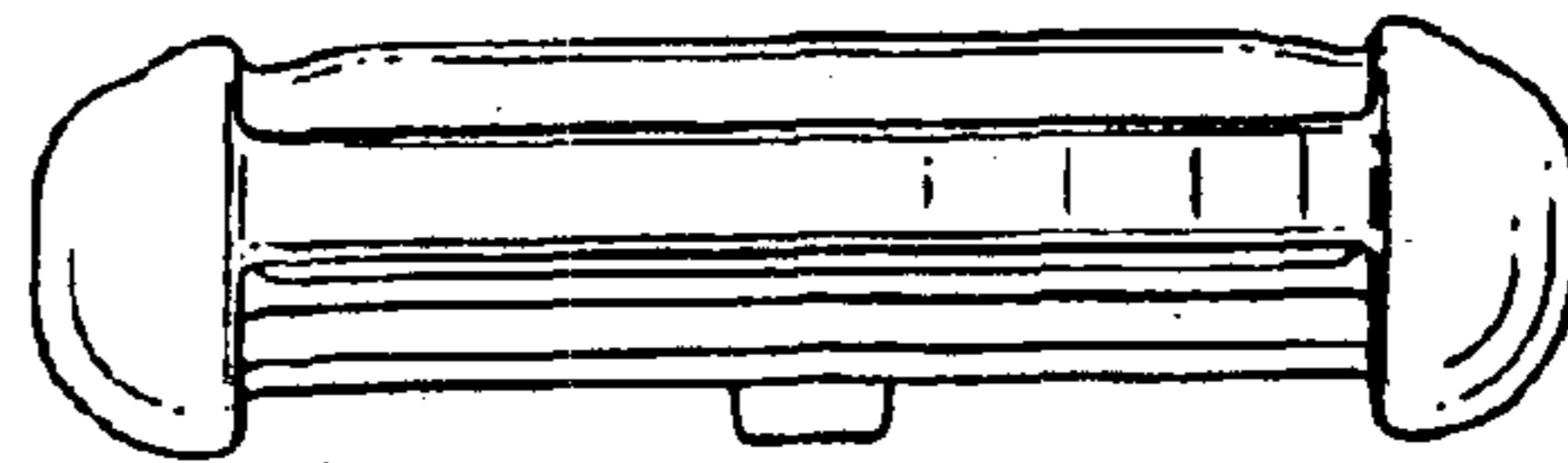

FIG. 12

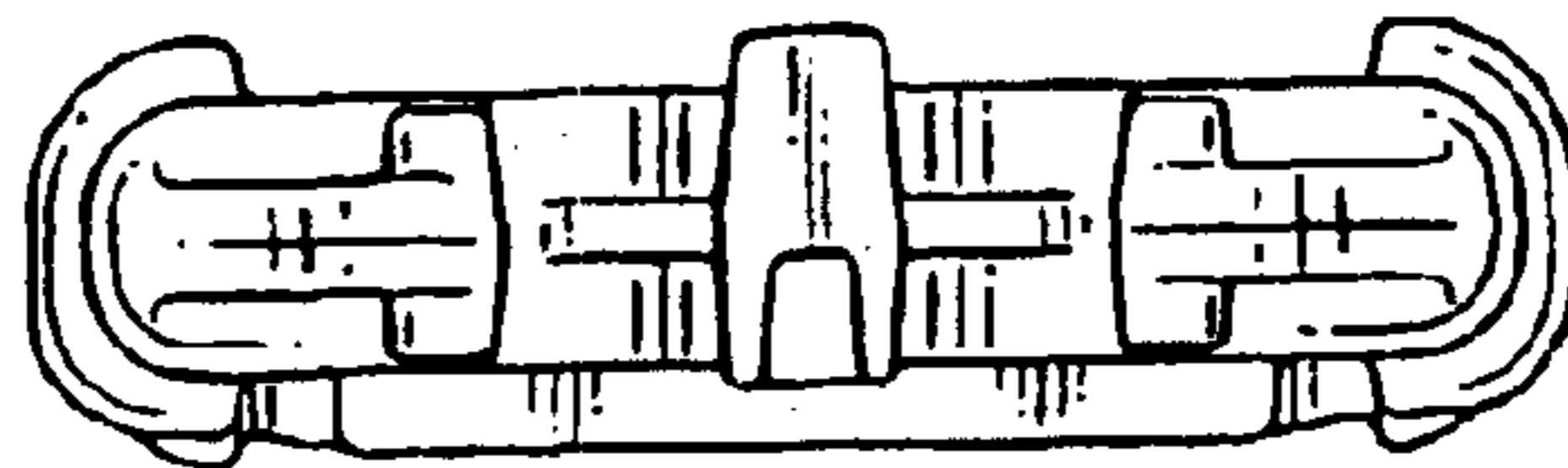

FIG. 13

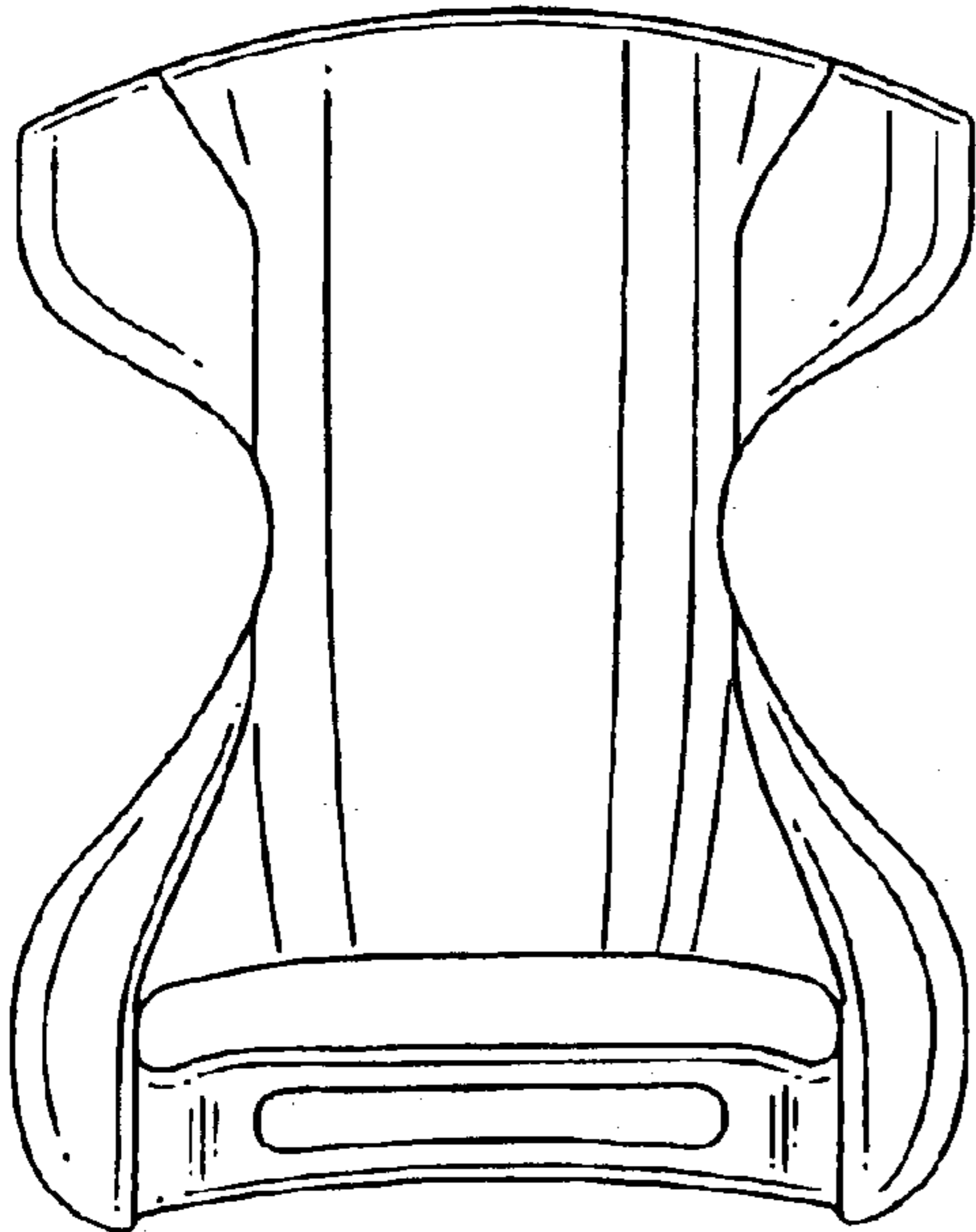

FIG. 14

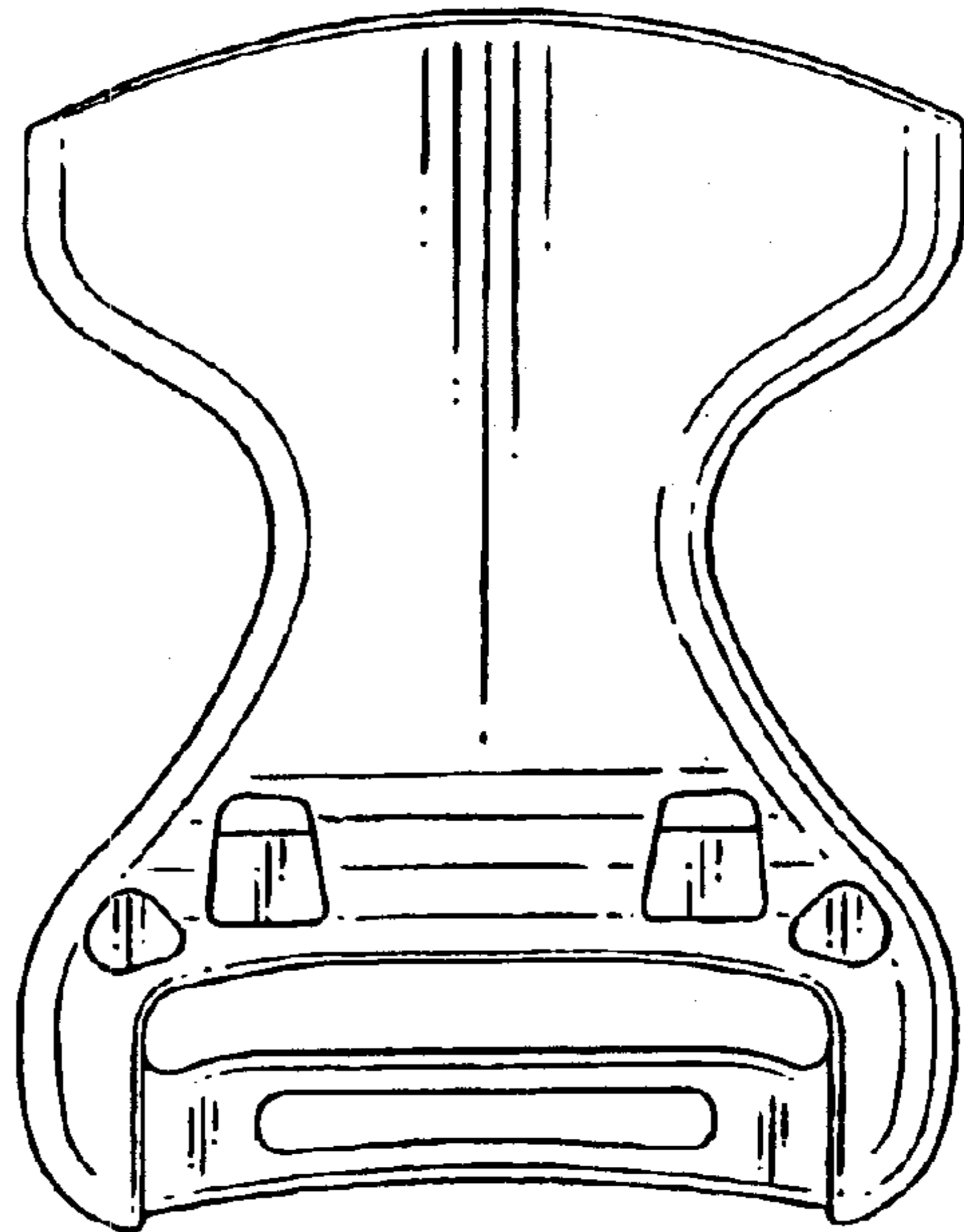

FIG. 15

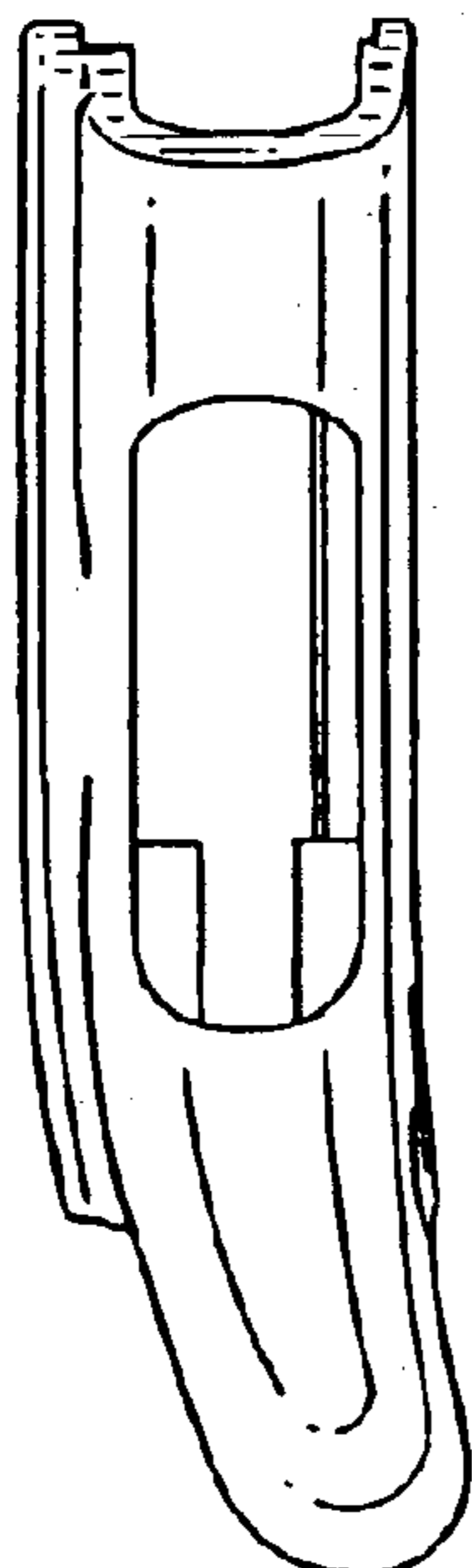

FIG. 16

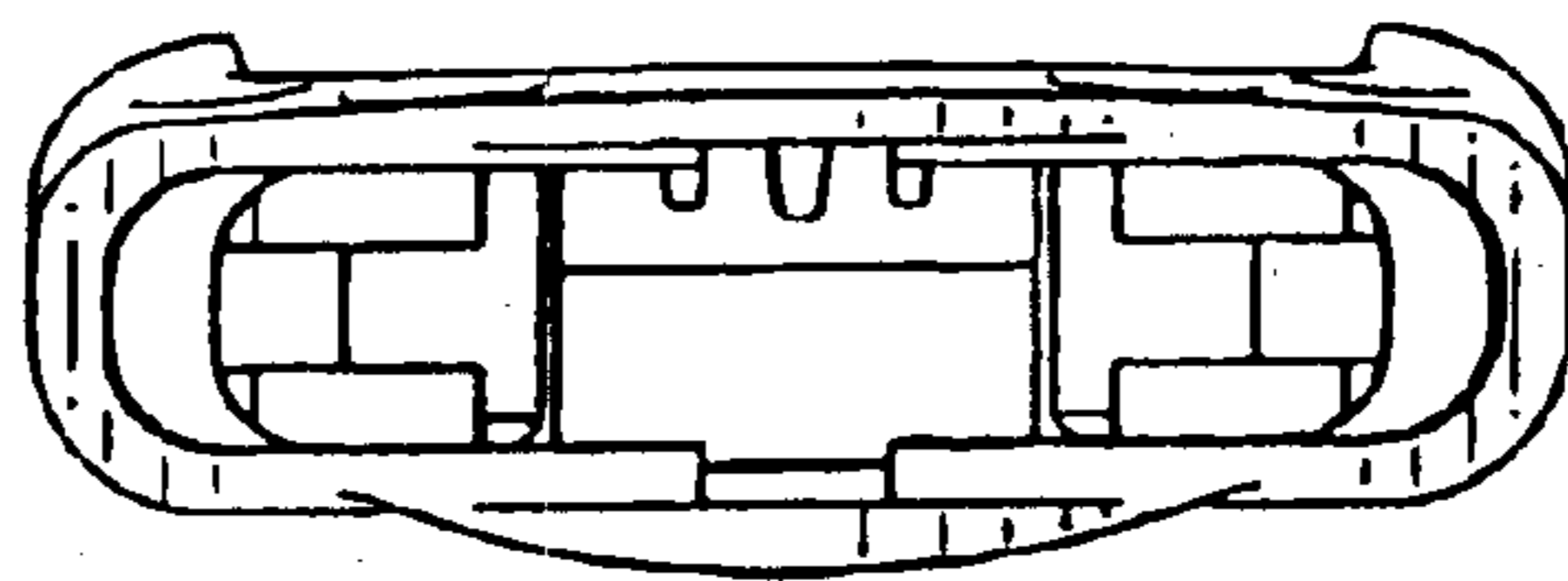

FIG. 17

