

US00D495445S1

(12) **United States Design Patent** (10) **Patent No.:** **US D495,445 S**
Cooper et al. (45) **Date of Patent:** **** Aug. 31, 2004**

(54) **LIGHT POLE**

(75) Inventors: **Alexander Cooper**, Englewood, NJ (US); **E. Keith Orlesky**, Maplewood, NJ (US); **Michel Dionne**, Roxbury, NY (US)

(73) Assignee: **Alliance for Downtown, New York, Inc.**, New York, NY (US)

(**) Term: **14 Years**

(21) Appl. No.: **29/182,576**

(22) Filed: **May 27, 2003**

(51) **LOC (7) Cl.** **26-05**

(52) **U.S. Cl.** **D26/67**

(58) **Field of Search** D26/24, 67-73, D26/84-92; D10/114; D25/128, 129; 362/145, 147, 153, 153.1, 186, 257, 276, 312, 330, 351, 354, 358, 361-363, 431-433, 806

(56) **References Cited**

U.S. PATENT DOCUMENTS

D42,283 S	*	3/1912	Grelle	D26/69
D69,100 S	*	12/1925	Victor	D26/68
D92,291 S	*	5/1934	Clarke	D26/68
D153,196 S	*	3/1949	Winters	D26/68
D200,593 S	*	3/1965	Petengill	D26/145
3,270,480 A	*	9/1966	Beecker	362/431
3,671,738 A	*	6/1972	Beachley	362/431
3,686,498 A	*	8/1972	Meyer	362/431
3,837,752 A	*	9/1974	Shewchuk	403/2
3,847,334 A	*	11/1974	Forsberg et al.	248/158
3,977,641 A	*	8/1976	Garchinsky	248/274.1
D426,012 S	*	5/2000	Giese et al.	D26/68
D488,084 S	*	4/2004	Cooper et al.	D25/128

OTHER PUBLICATIONS

Downtown New York Streetscape Plan, Jan. 1999.
Picture, S (Street) Pole Prototype, Jun. 2001.
Picture, P (Pedestrian) Pole Prototype, Jun. 2001.

* cited by examiner

Primary Examiner—Clare E Heflin

(74) *Attorney, Agent, or Firm*—Milbank, Tweed, Hadley & McCloy LLP

(57) **CLAIM**

The ornamental design for a light pole, as shown and described.

DESCRIPTION

FIG. 1 is a right side elevation view of a light pole showing our new design;
FIG. 2 is a top plan view thereof;
FIG. 3 is a bottom plan view thereof;
FIG. 4 is a cross-sectional view thereof, as indicated in the section line 4—4 in FIG. 1;
FIG. 5 is a cross-sectional view thereof, as indicated in the section line 5—5 in FIG. 1;
FIG. 6 is a cross-sectional view thereof, as indicated in the section line 6—6 in FIG. 1;
FIG. 7 is a cross-sectional view thereof, as indicated in the section line 7—7 in FIG. 1;
FIG. 8 is a cross-sectional view thereof, as indicated in the section line 8—8 in FIG. 1; and,
FIG. 9 is an enlarged view thereof as illustrated in FIG. 2. The left side elevation view, the front side elevation view and the back side elevation view are images of the right side elevation view in FIG. 1.

1 Claim, 2 Drawing Sheets

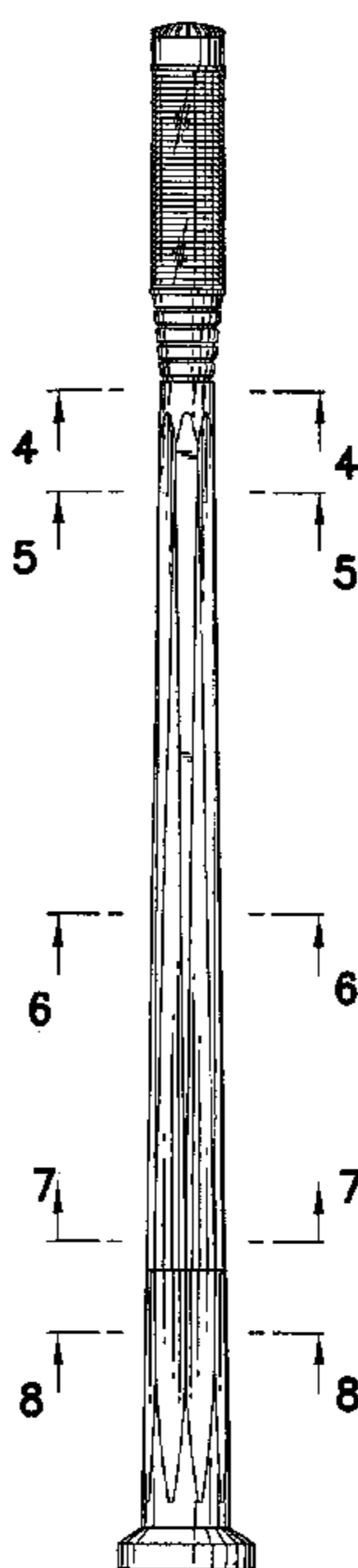

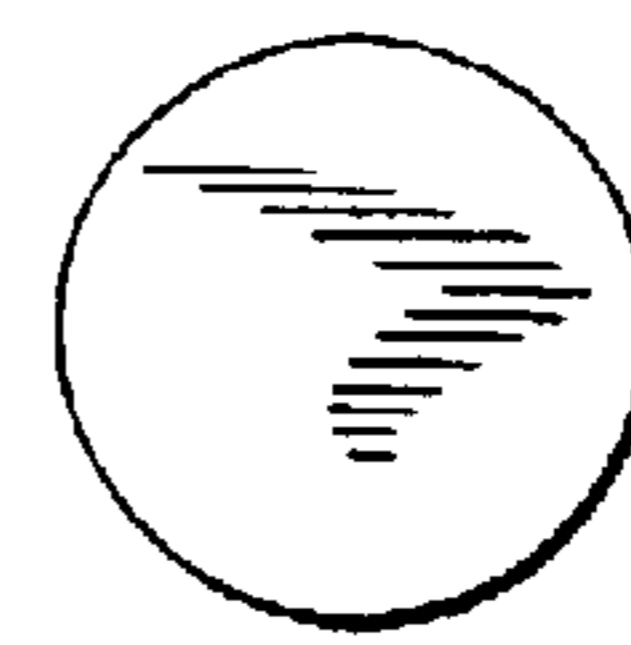
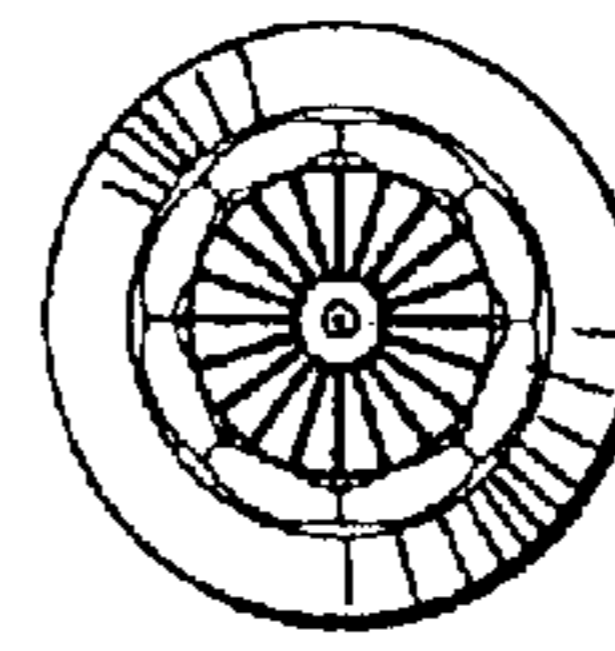
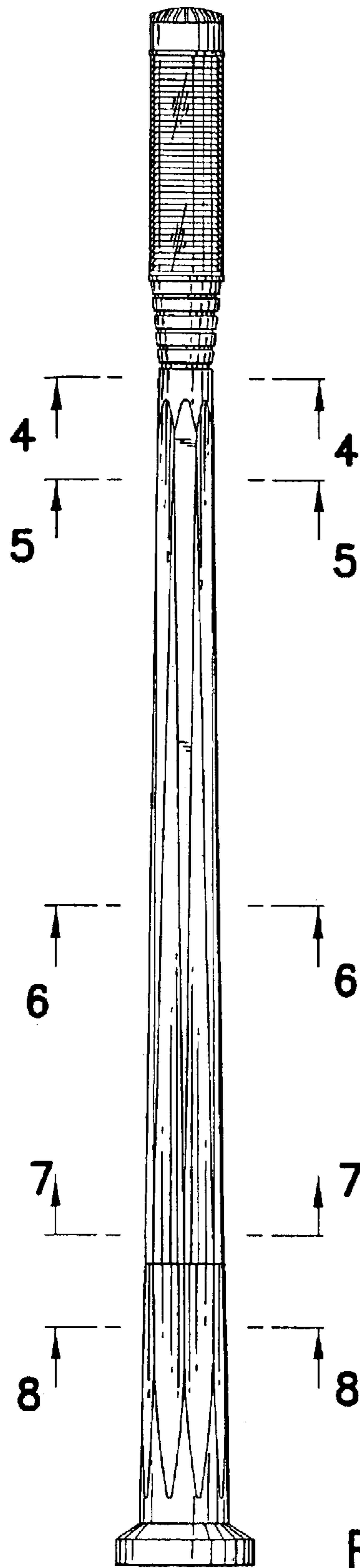

FIG.4

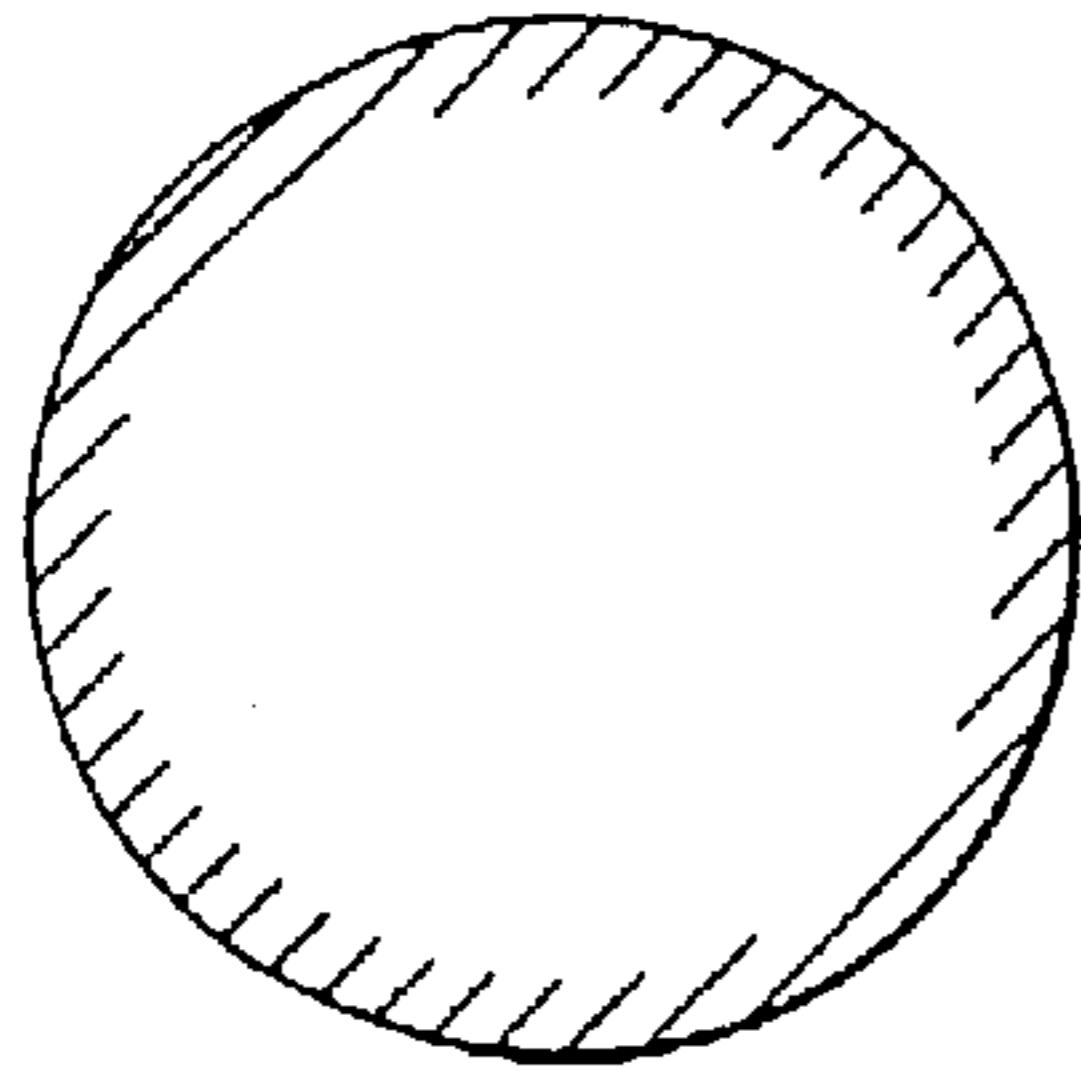

FIG.5

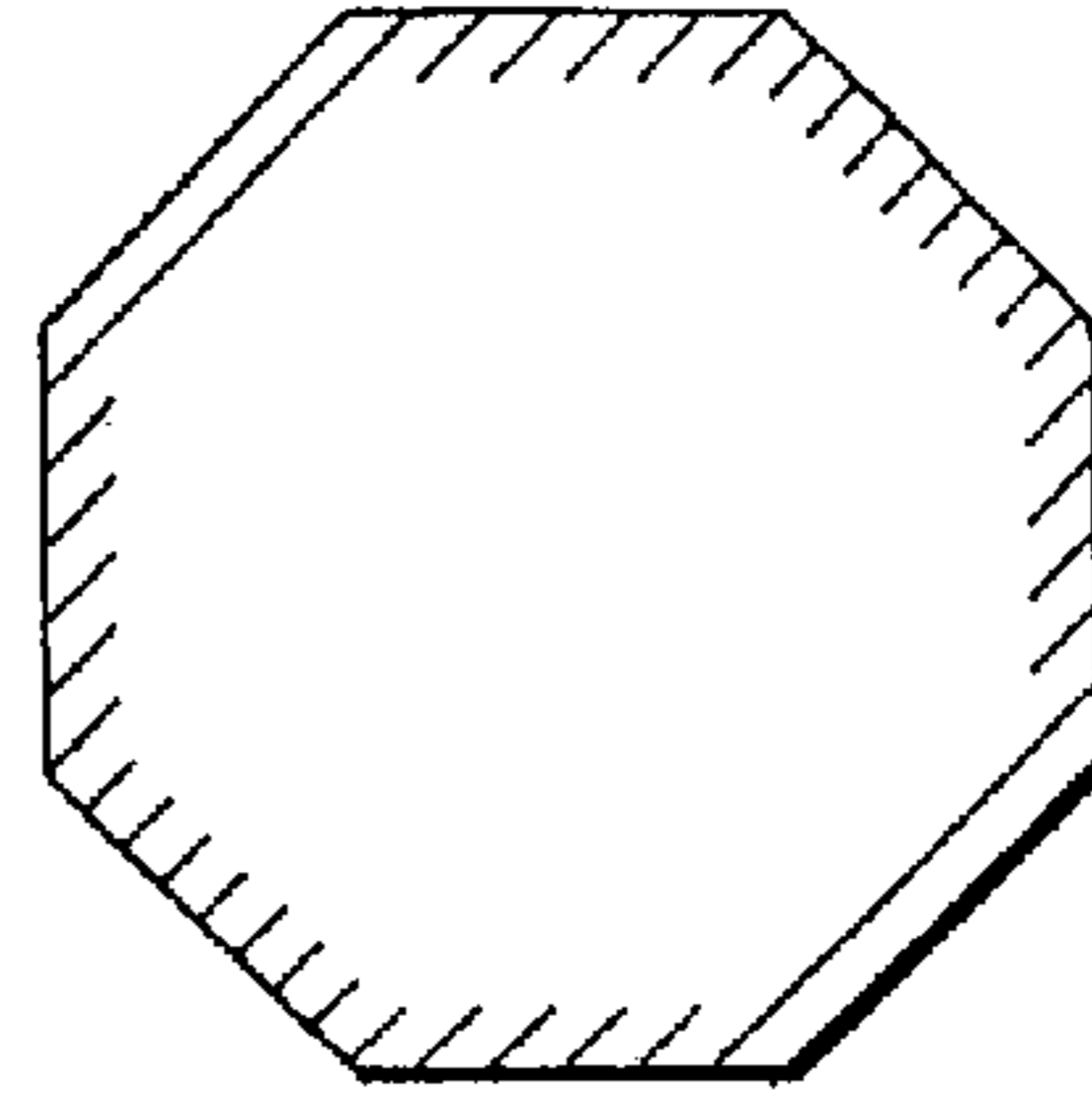

FIG.6

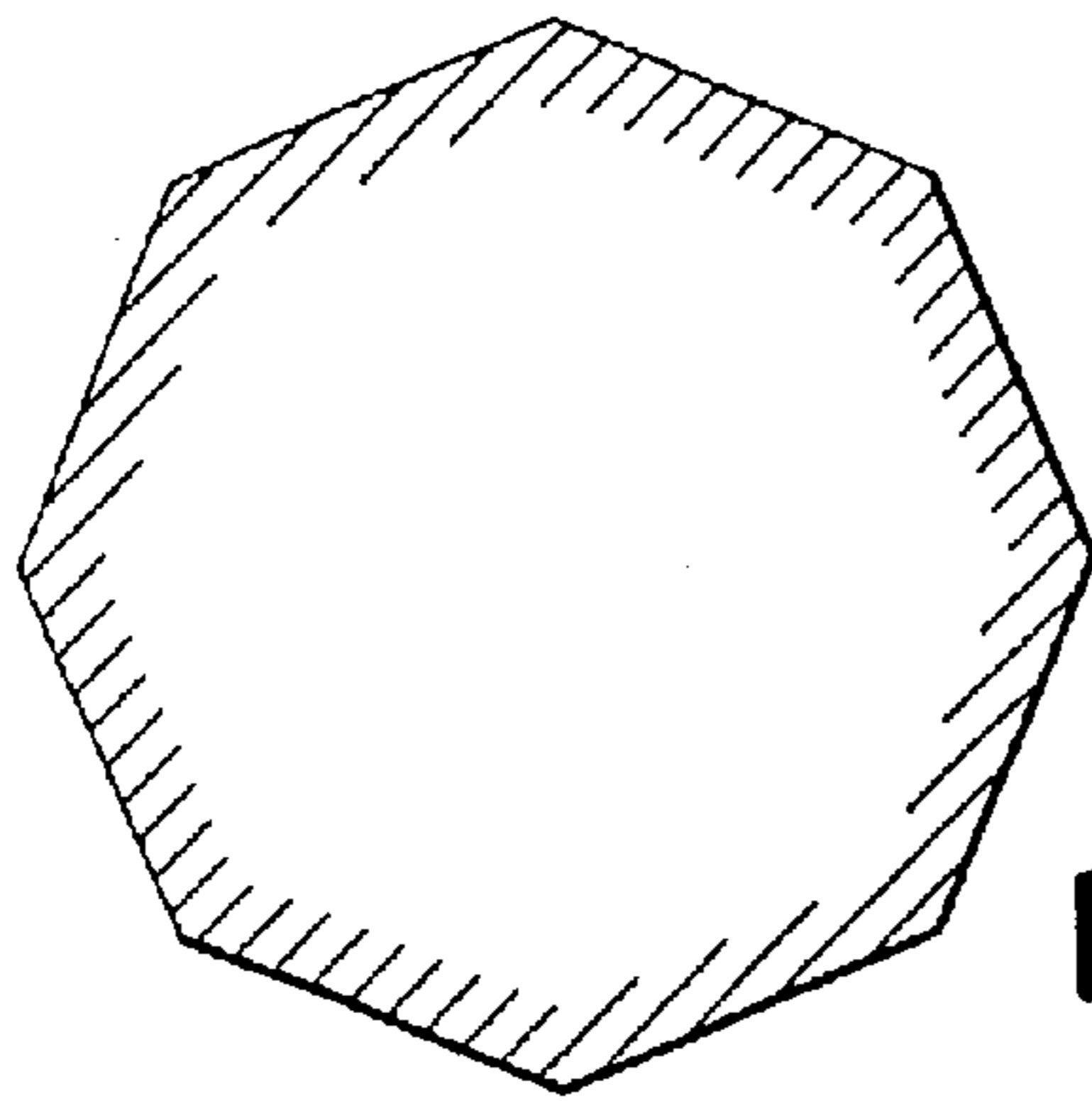
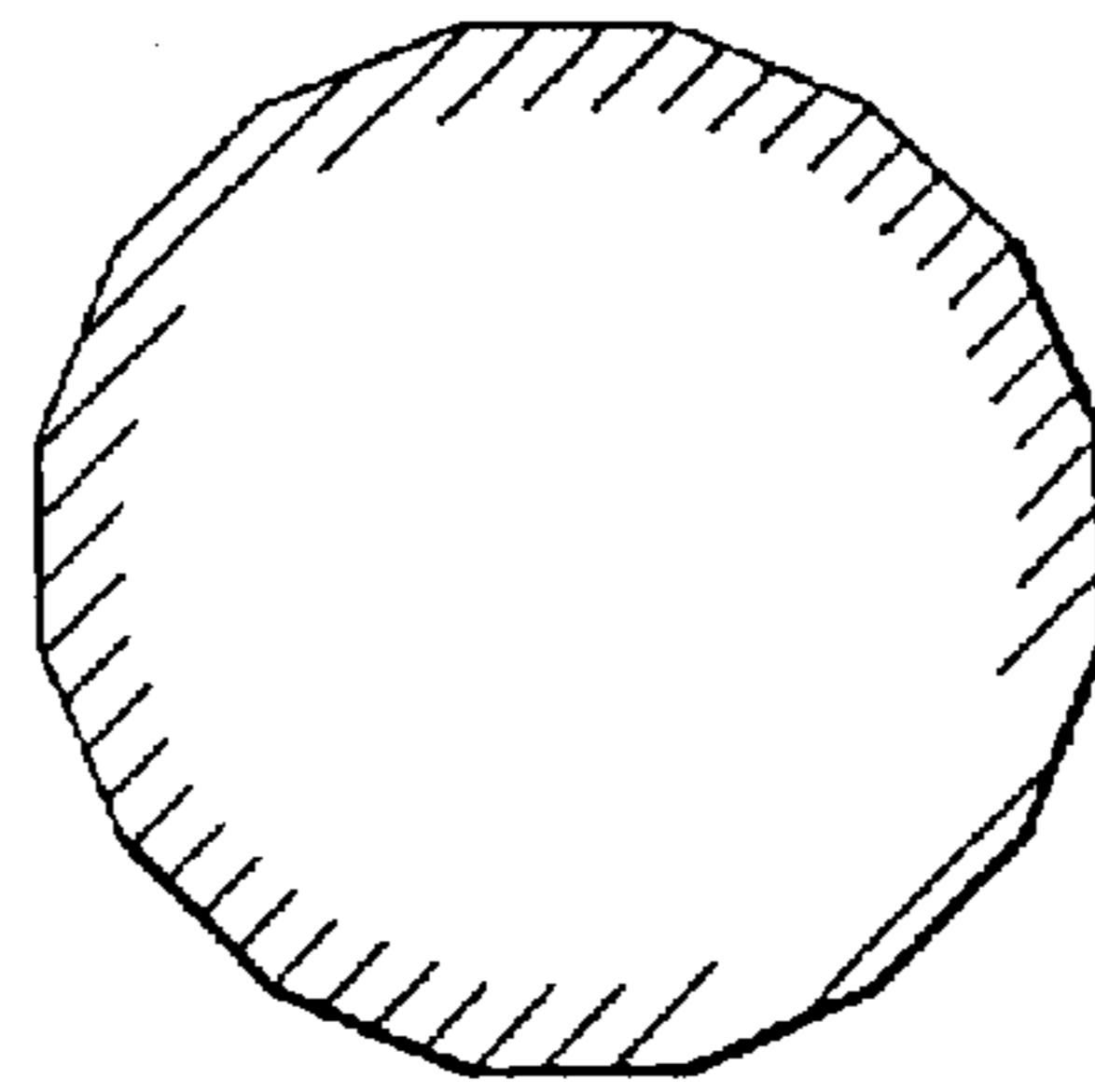

FIG.7

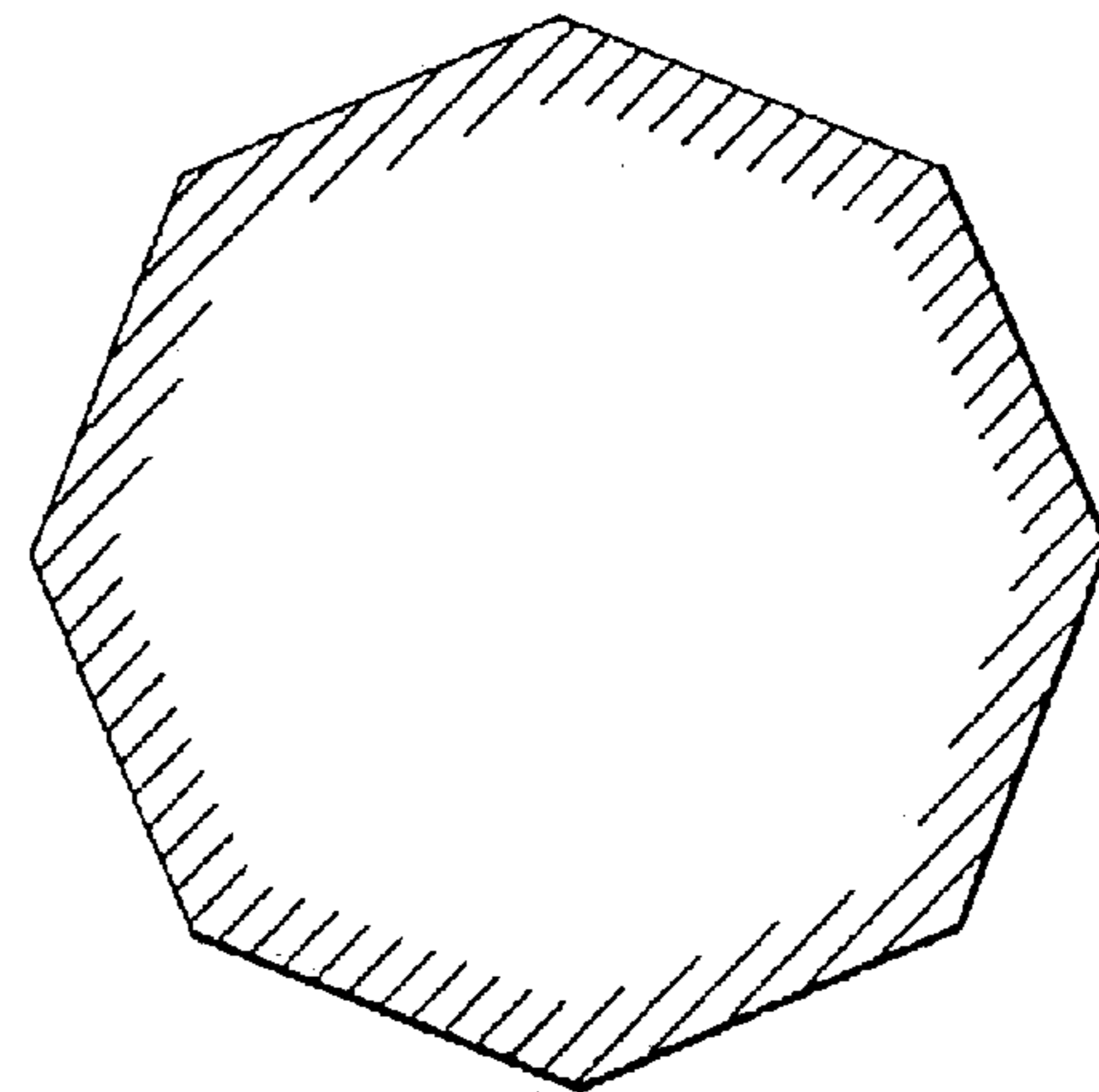

FIG.8

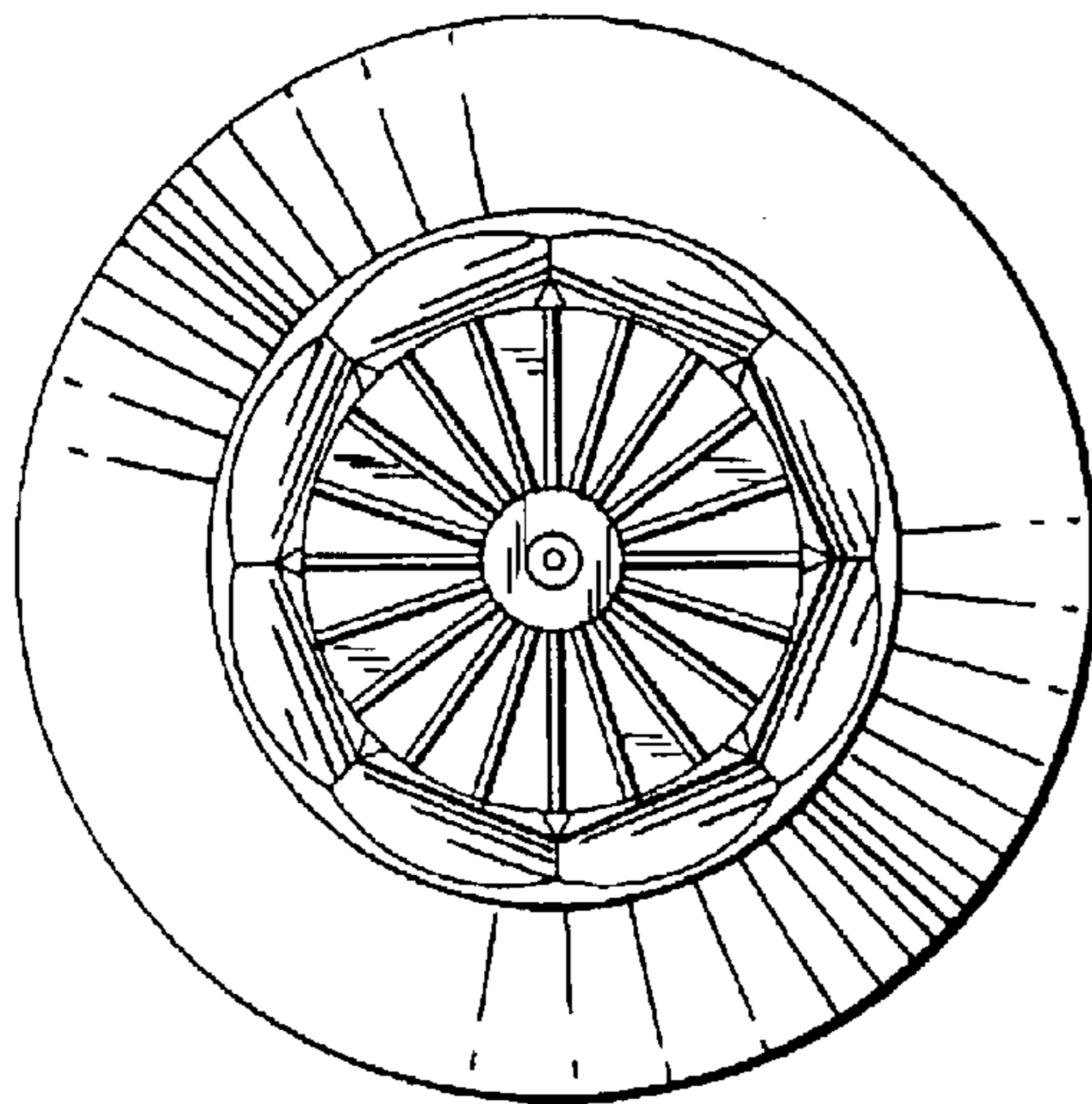

FIG.9