

US00D495368S1

(12) **United States Design Patent** (10) **Patent No.:** **US D495,368 S**  
**Hardy** (45) **Date of Patent:** **\*\* Aug. 31, 2004**

(54) **PORTION OF AN ORGANIZER CUP**

(75) **Inventor:** **Christopher Hardy**, Springfield, IL (US)

(73) **Assignee:** **Design Ideas, Ltd.**, Springfield, IL (US)

(\*\*) **Term:** **14 Years**

(21) **Appl. No.:** **29/173,224**

(22) **Filed:** **Dec. 23, 2002**

(51) **LOC (7) Cl.** ..... **19-06**

(52) **U.S. Cl.** ..... **D19/77; D19/85; D19/75; D7/641**

(58) **Field of Search** ..... **D19/65, 75, 77, D19/78, 81-85, 95, 99, 100; 206/214, 224, 371; 211/69.1-69.9, 13.1; D7/641; D3/206, 306; D11/155; 40/720**

(56) **References Cited**

**U.S. PATENT DOCUMENTS**

3,716,936	A	*	2/1973	Miller	.....	40/720
3,771,246	A	*	11/1973	Ebner	.....	40/720
D234,530	S	*	3/1975	Waltzman	.....	D11/155
4,195,729	A	*	4/1980	Macken	.....	40/720 X
D326,113	S	*	5/1992	Galante	.....	D19/78
D329,663	S	*	9/1992	Galante	.....	D19/78
5,487,466	A	*	1/1996	Robson	.....	206/214
5,816,416	A	*	10/1998	Tsai	.....	211/69.1
D431,907	S	*	10/2000	Andujar et al.	.....	D3/306
D436,626	S	*	1/2001	Wang	.....	D19/85
D444,177	S	*	6/2001	Carretta	.....	D19/85

**OTHER PUBLICATIONS**

Staples Catalogue, 2003 line of Expressions Punched Metal and Wood desk set and Mahogany Finish Wood desk set, pp. 1 and 2 in color, Oct. 2002.

\* cited by examiner

*Primary Examiner*—Martie K. Holtje

(74) *Attorney, Agent, or Firm*—SAIDMAN DesignLaw Group

(57) **CLAIM**

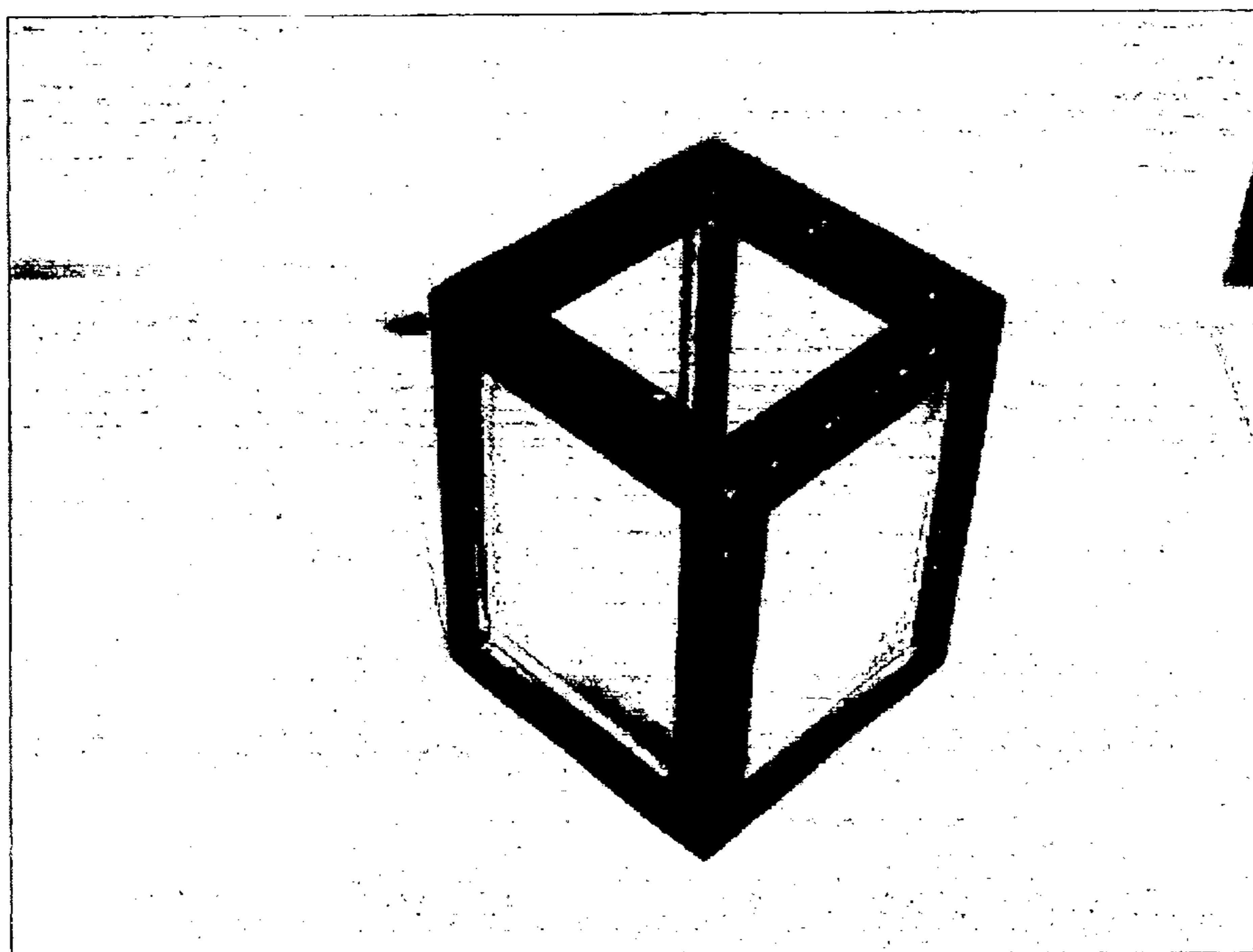
The ornamental design for a portion of an organizer cup, as shown and described.

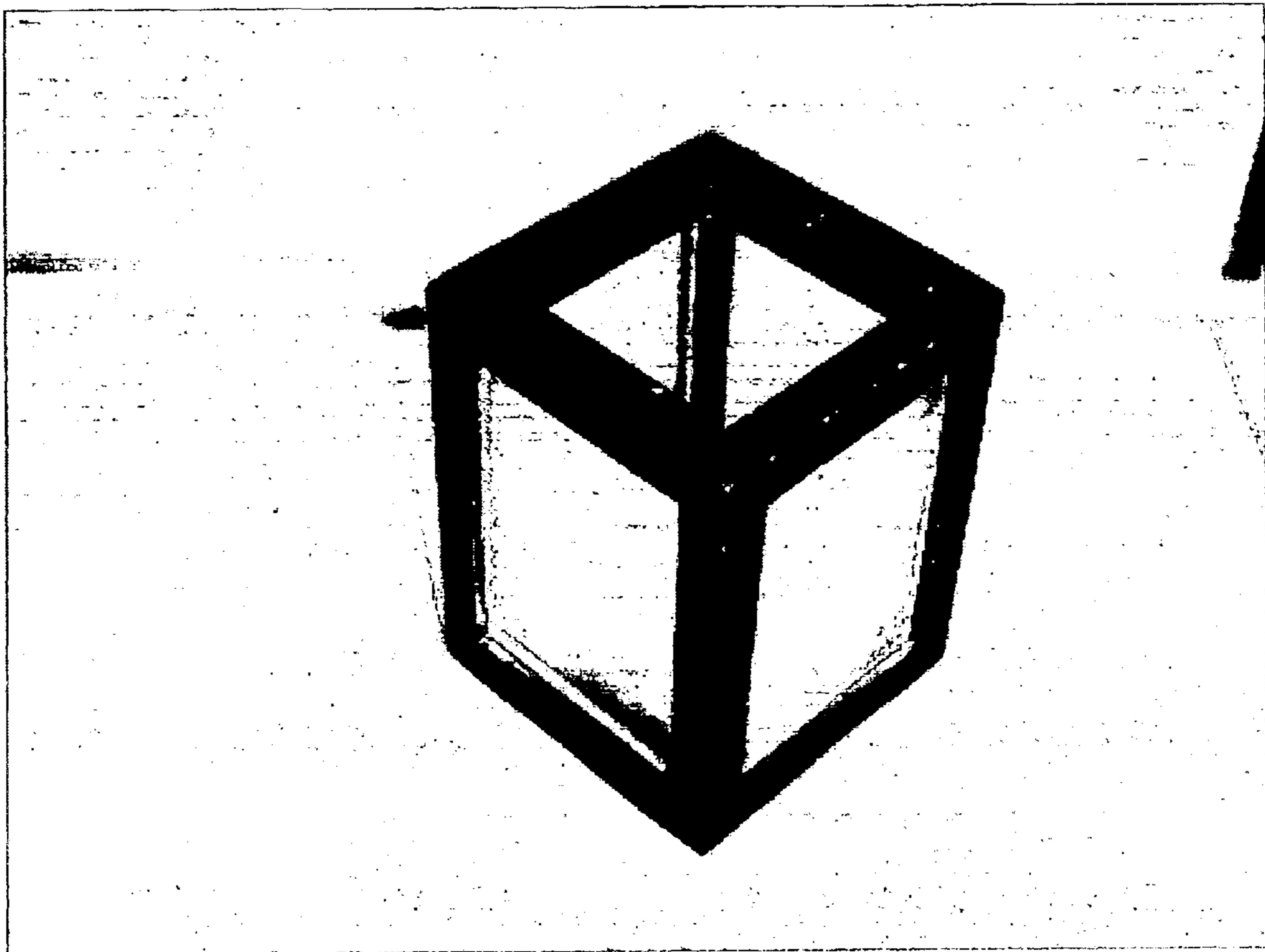
**DESCRIPTION**

FIG. 1 is a top, perspective view of a first embodiment of a portion of an organizer cup showing my new design; FIG. 2 is a bottom, perspective view thereof; FIG. 3 is a side, perspective view thereof, the three remaining side, perspective views being identical; FIG. 4 is a top, perspective view thereof; FIG. 5 is a bottom view thereof; FIG. 6 is a top, perspective view of a second embodiment of a portion of an organizer cup showing my new design; FIG. 7 is a bottom, perspective view thereof; FIG. 8 is a side view thereof, the three remaining side views being duplicates; FIG. 9 is a top, perspective view thereof; and, FIG. 10 is a bottom view thereof.

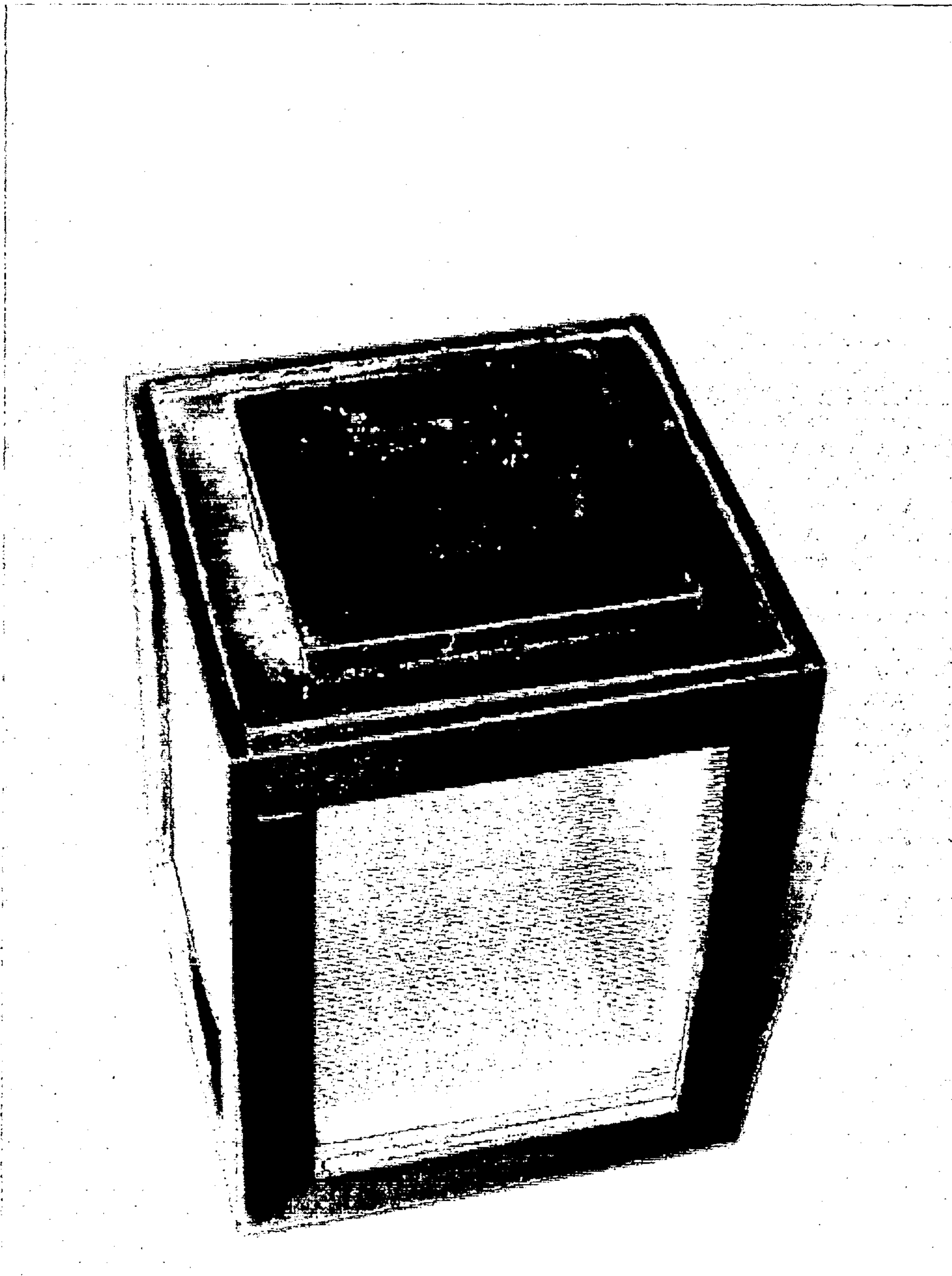
The broken lines in the drawings form no part of the claimed design. The jagged broken lines in the drawings form no part of the claimed design and the subject matter between such jagged lines is broken away to disclose indeterminate length.

**1 Claim, 10 Drawing Sheets**





**FIG. 1**



**FIG. 2**

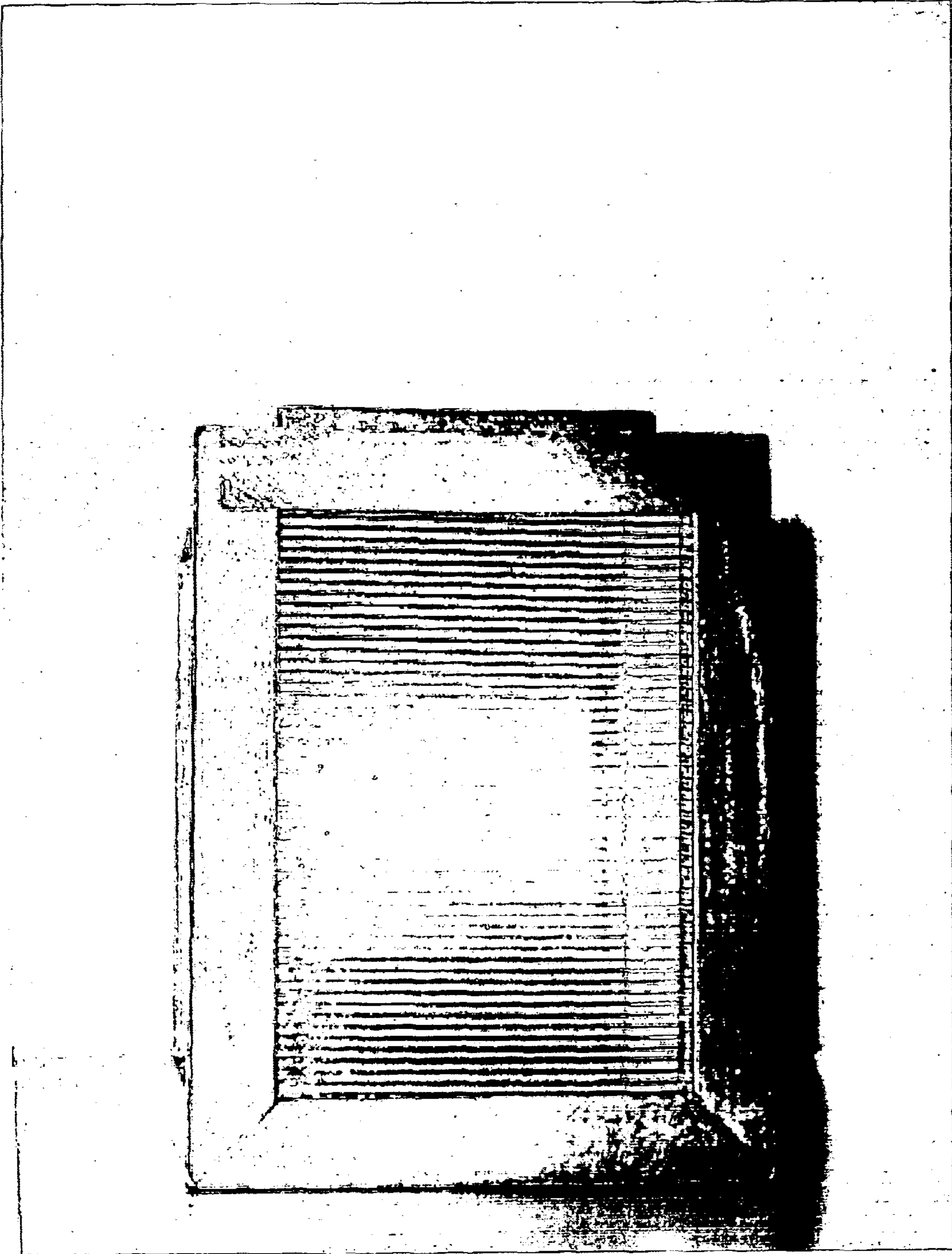
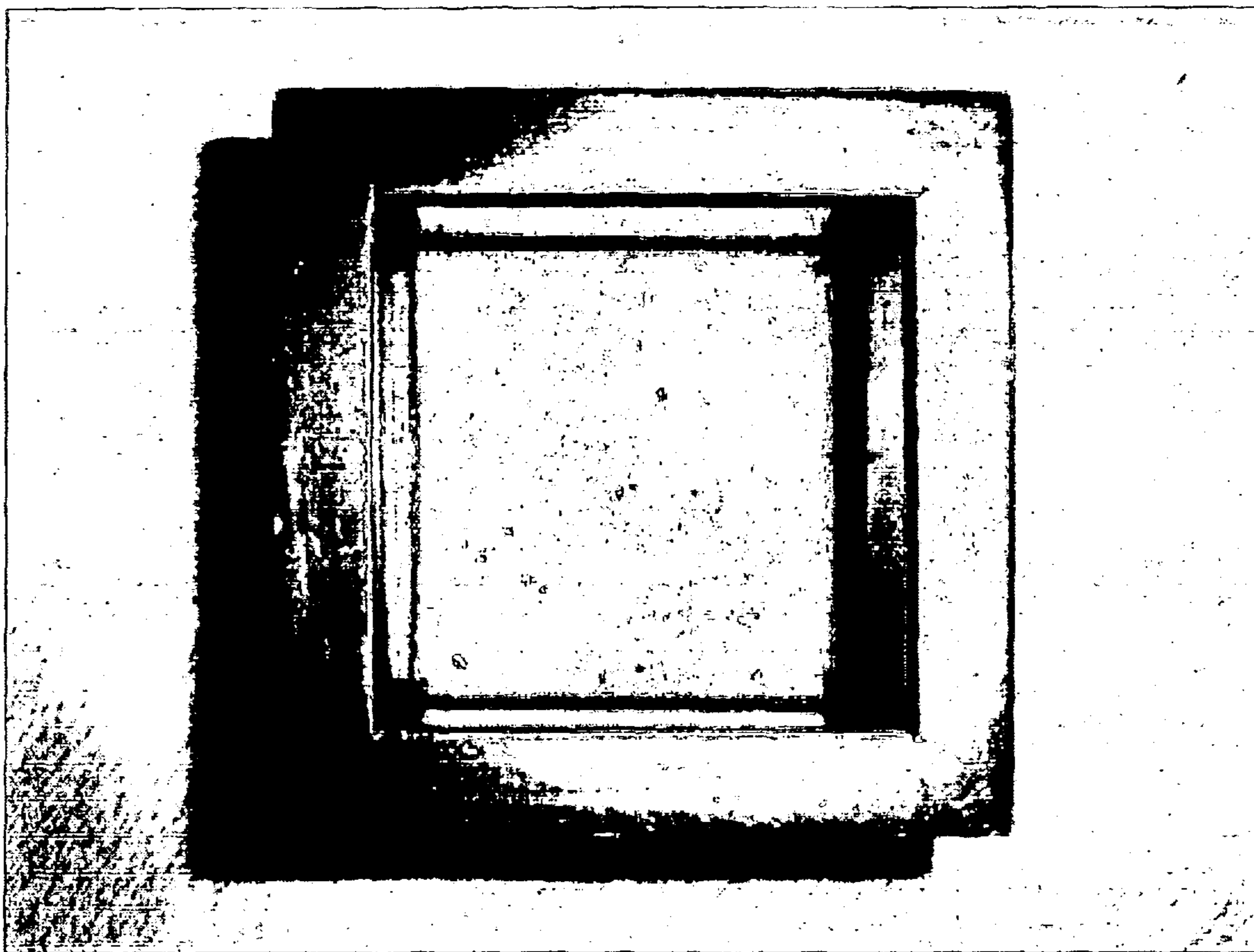
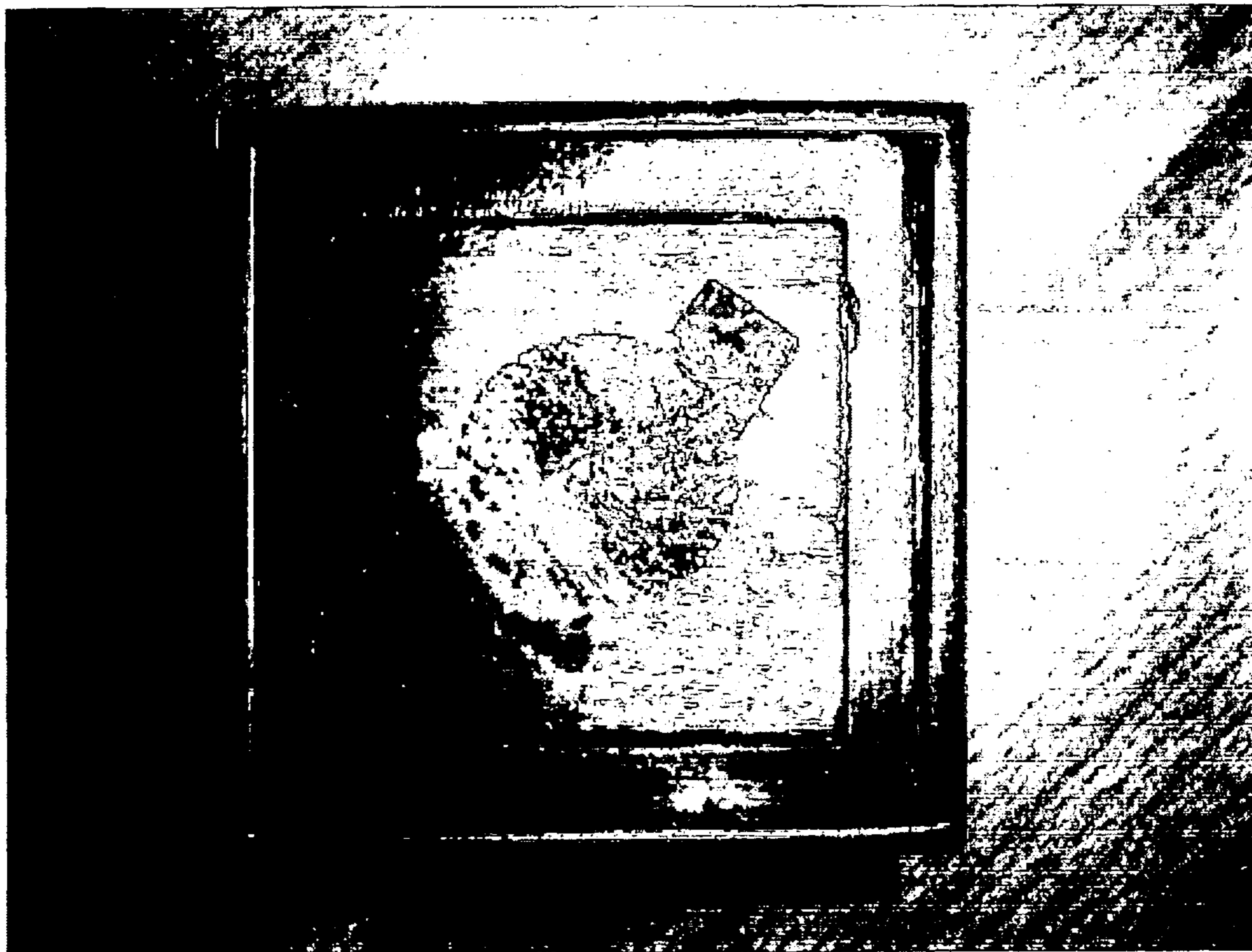


FIG. 3



**FIG. 4**



**FIG. 5**

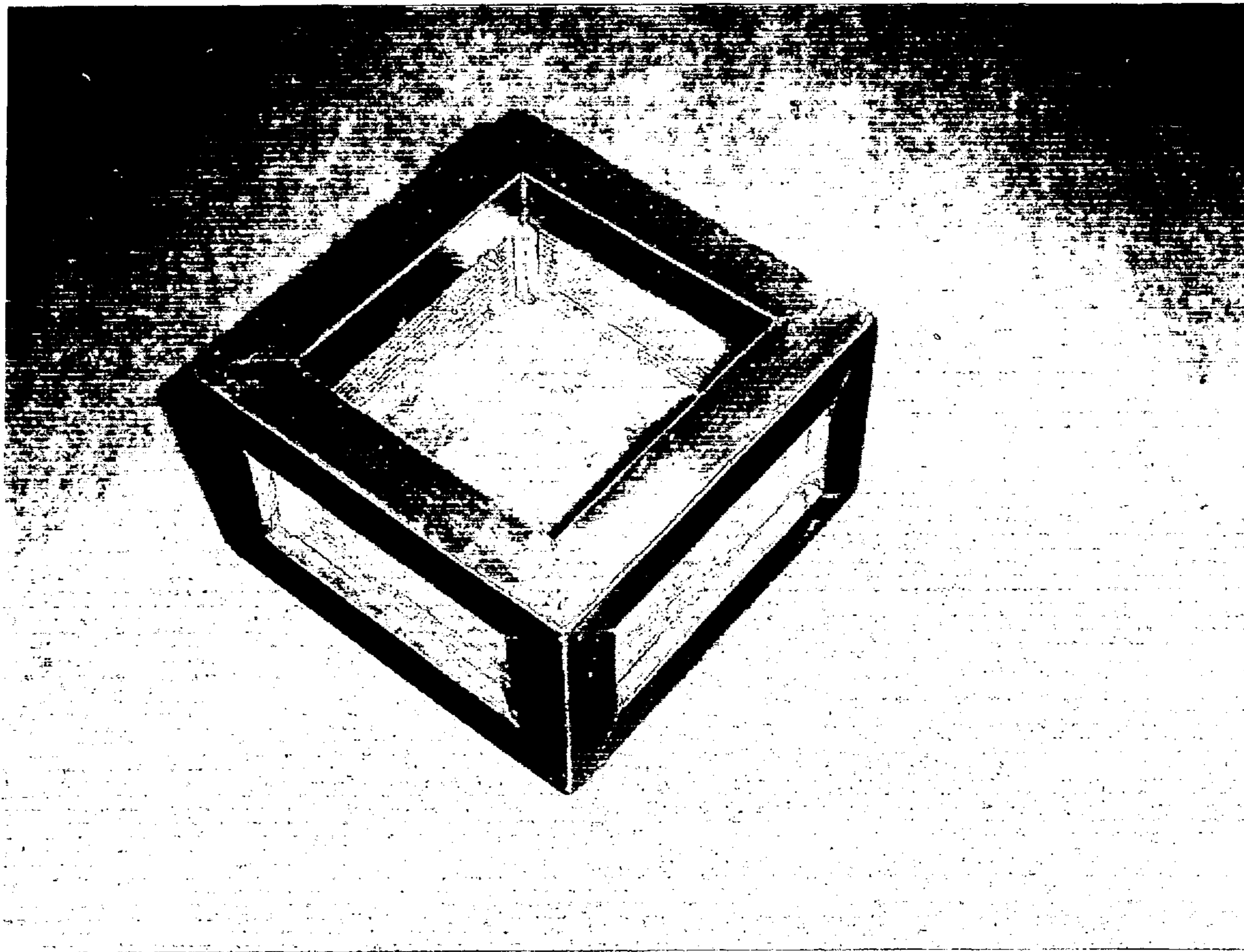


FIG. 6

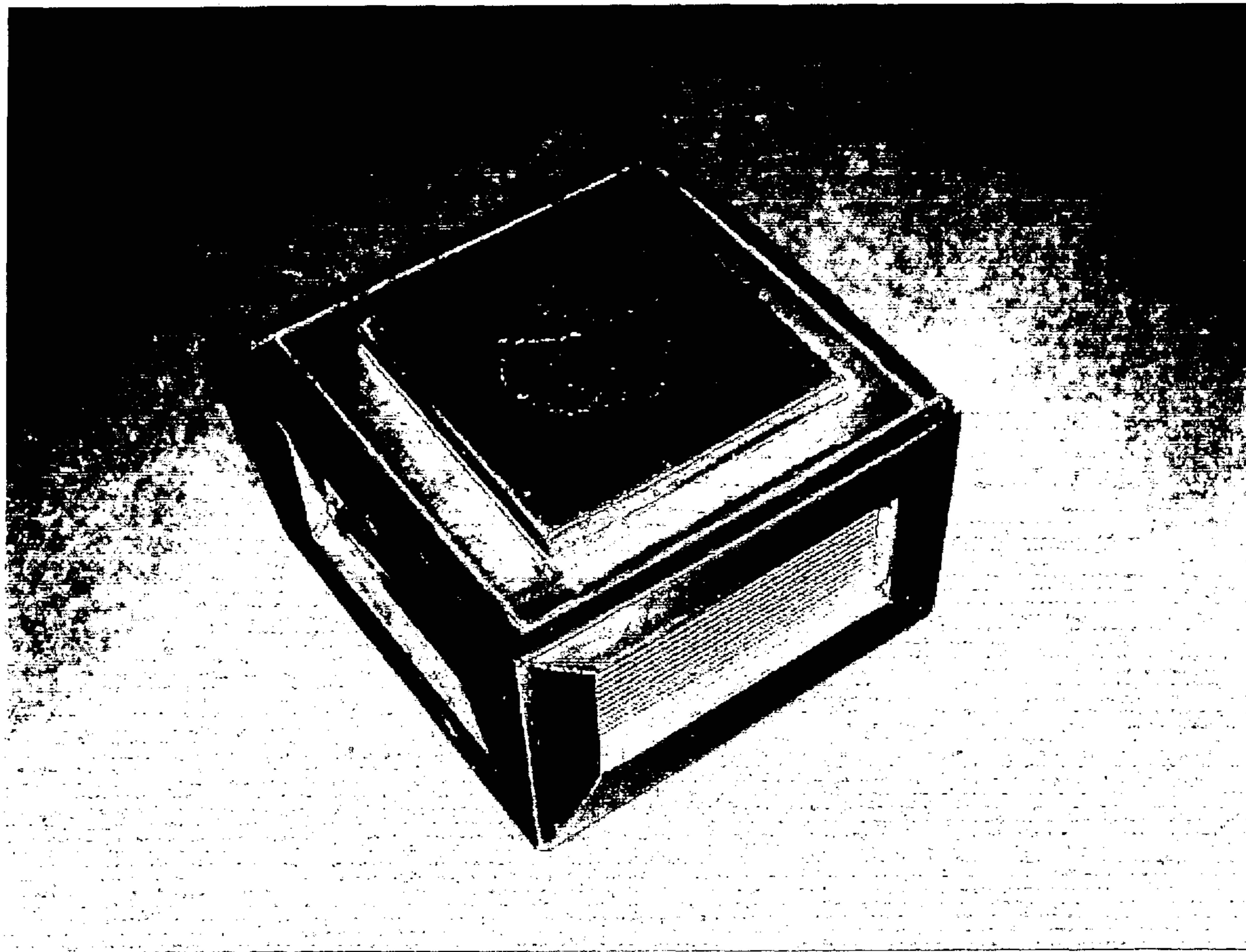


FIG. 7



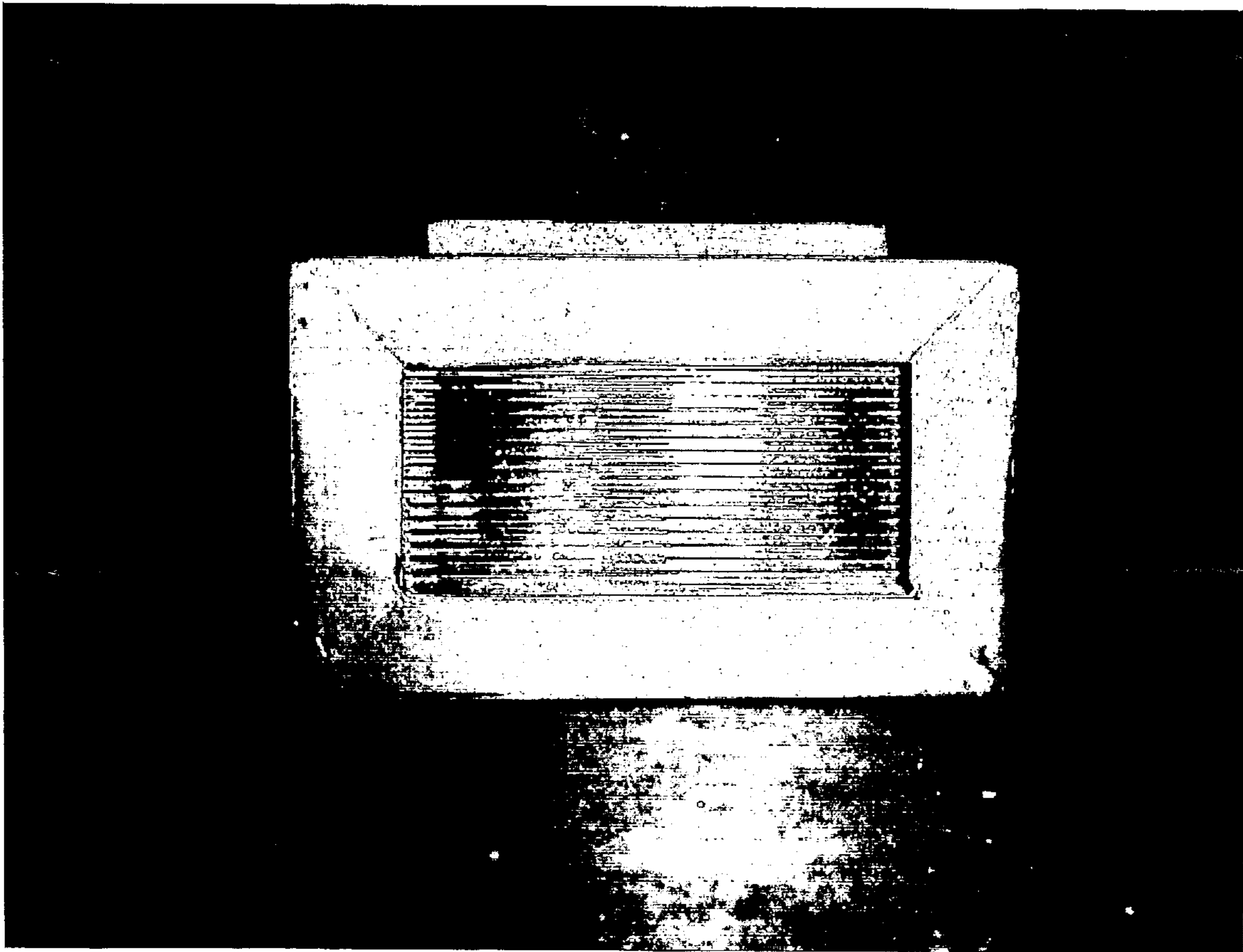


FIG. 8

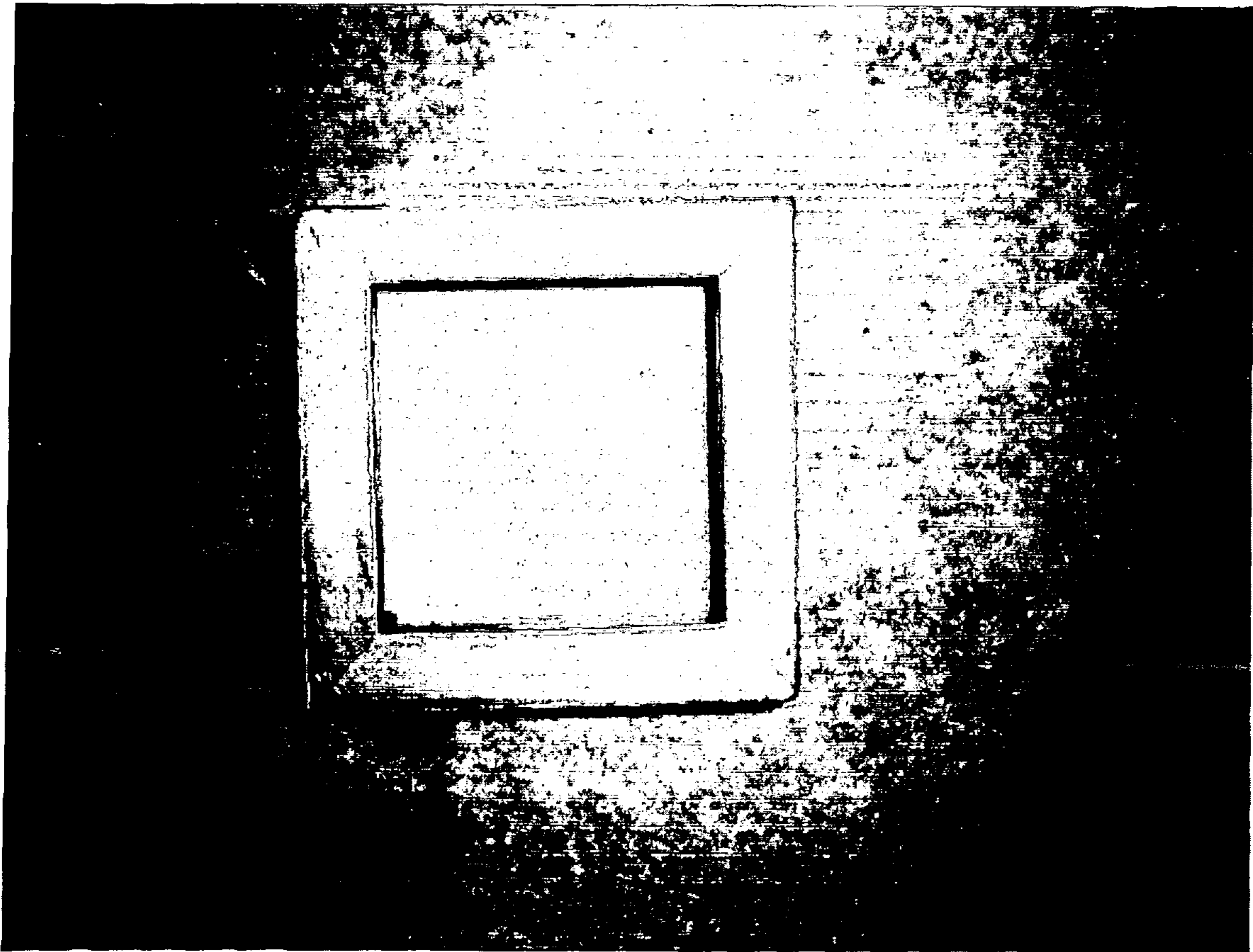


FIG. 9

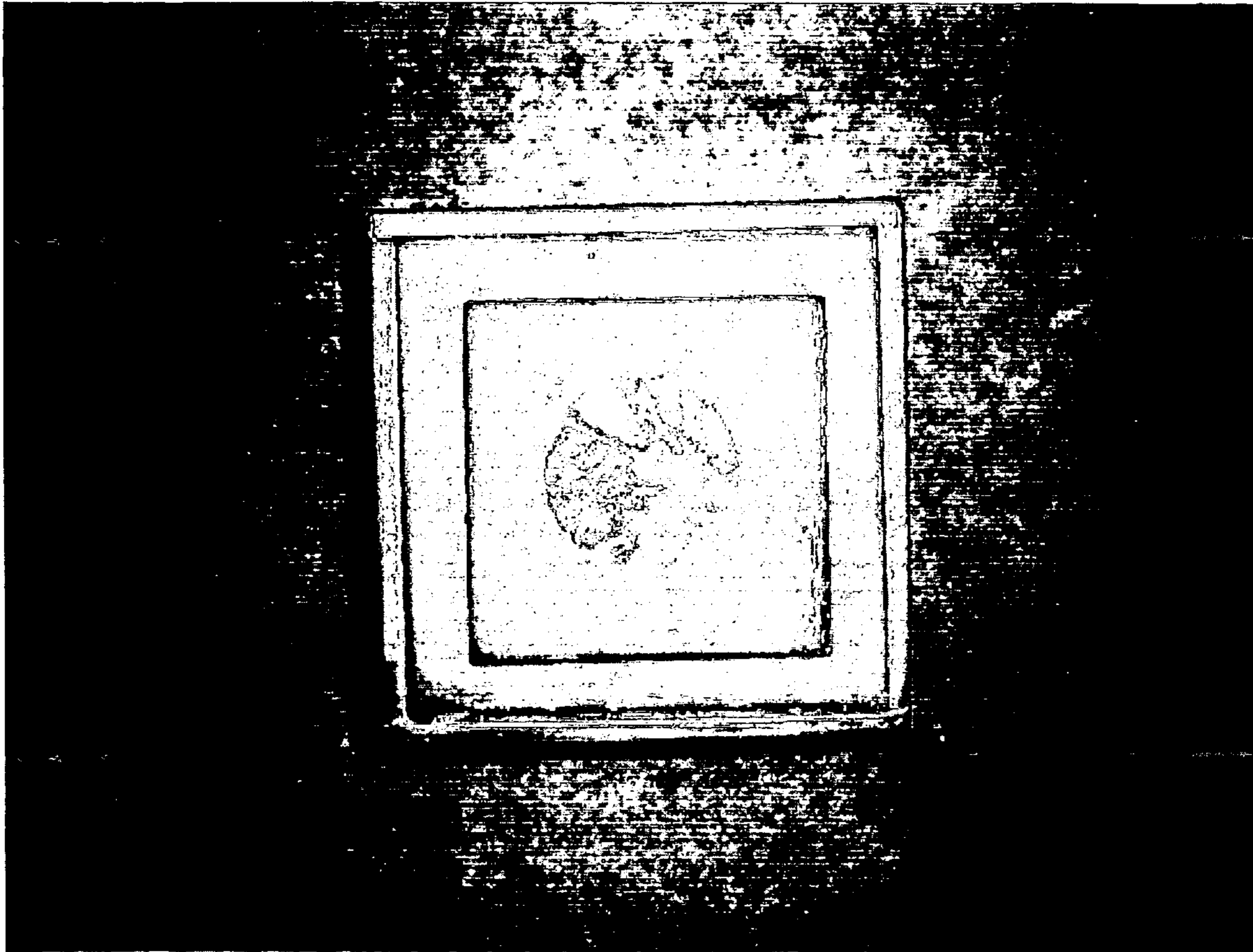


FIG. 10

UNITED STATES PATENT AND TRADEMARK OFFICE  
**CERTIFICATE OF CORRECTION**

PATENT NO. : Des. 495,368 S  
DATED : August 31, 2004  
INVENTOR(S) : Christopher Hardy

Page 1 of 11

It is certified that error appears in the above-identified patent and that said Letters Patent is hereby corrected as shown below:

Delete Drawing Sheets consisting of FIGS. 1-10 and replace with the following attached drawings.

Title page,

Item [56], **References Cited**, OTHER PUBLICATIONS, insert

-- 2000 Design Ideas Catalogue, cover page and Candle Light pages #1 - #3 --.

Signed and Sealed this

Twenty-first Day of February, 2006

A handwritten signature in black ink on a dotted background. The signature reads "Jon W. Dudas" in a cursive style.

JON W. DUDAS

*Director of the United States Patent and Trademark Office*

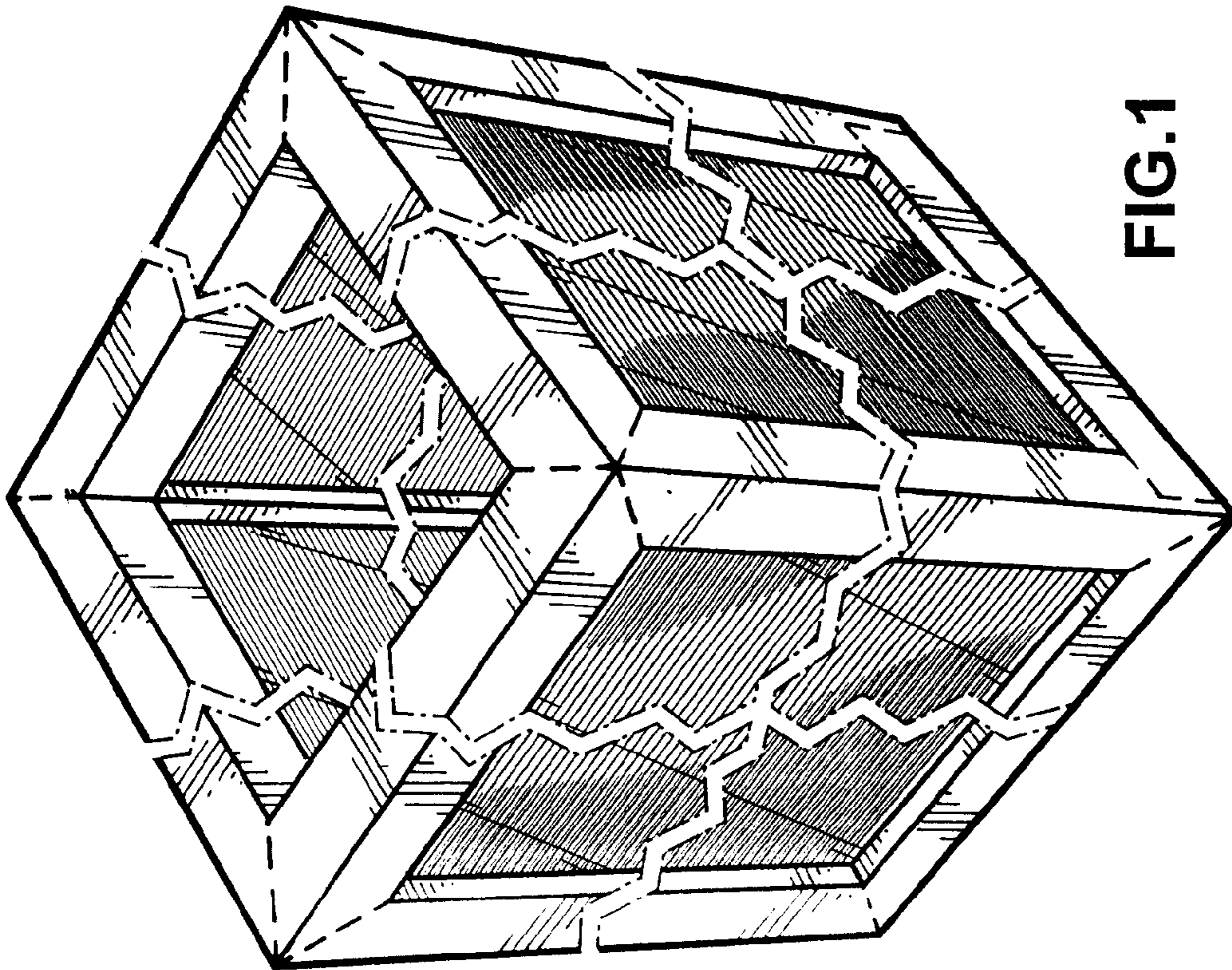
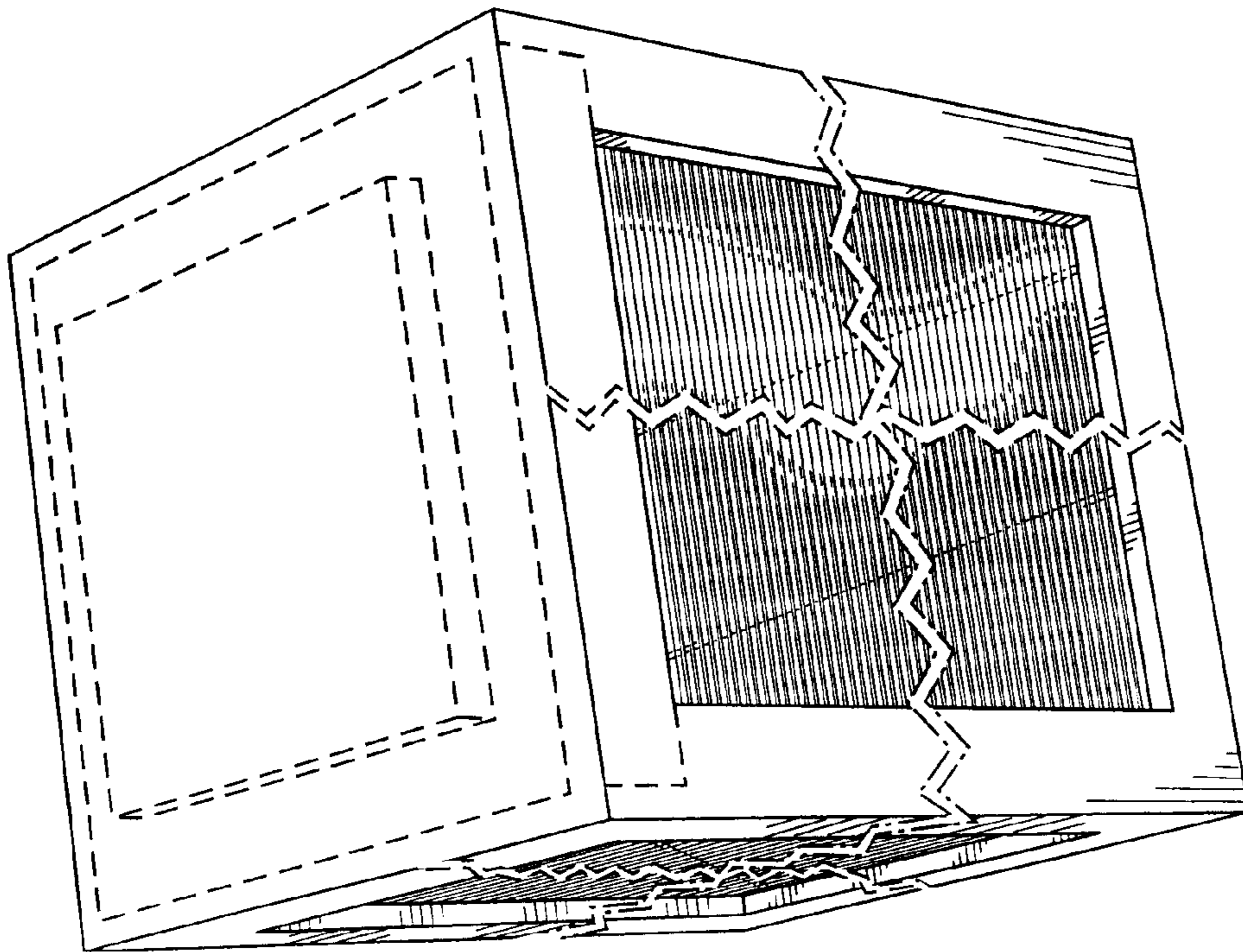
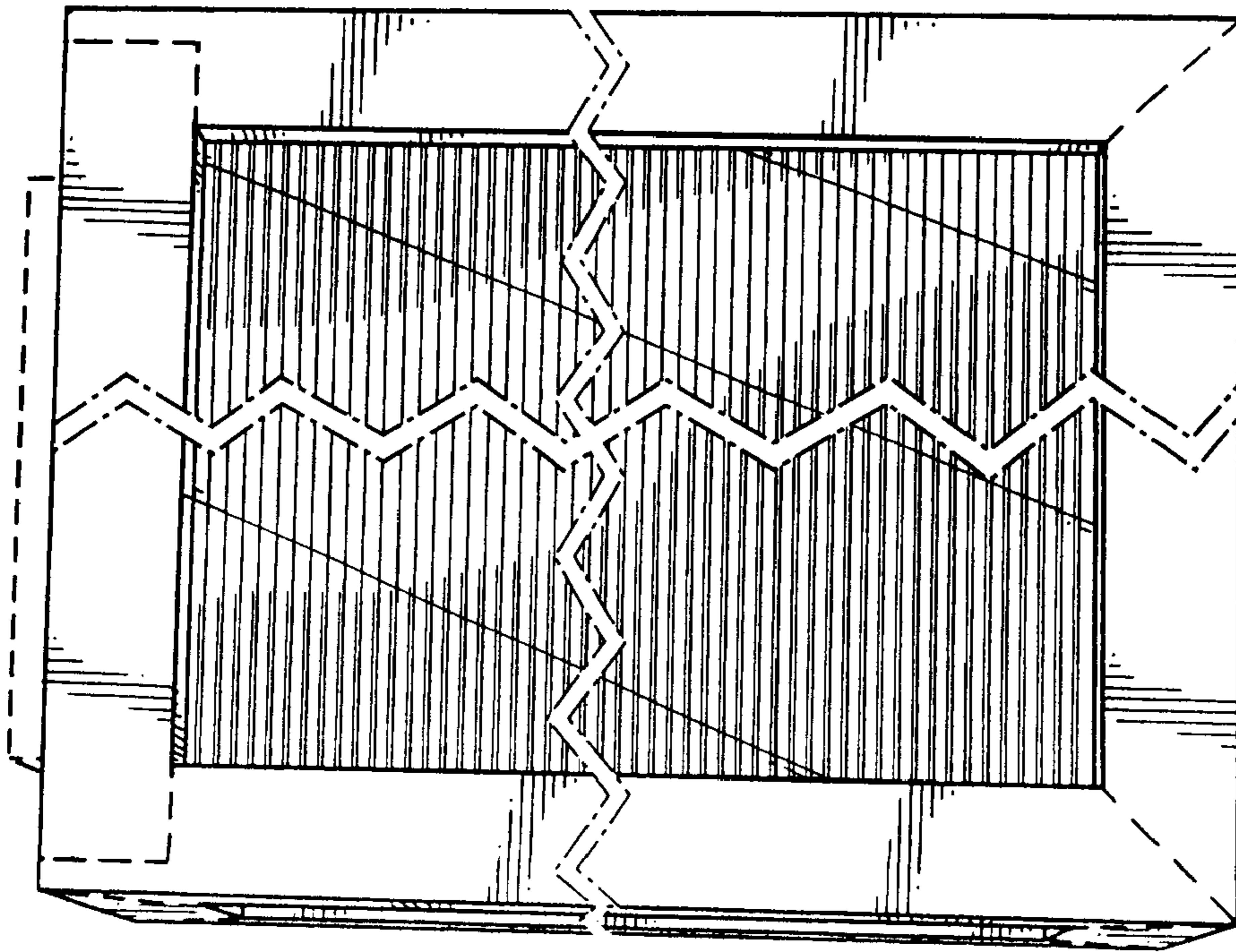


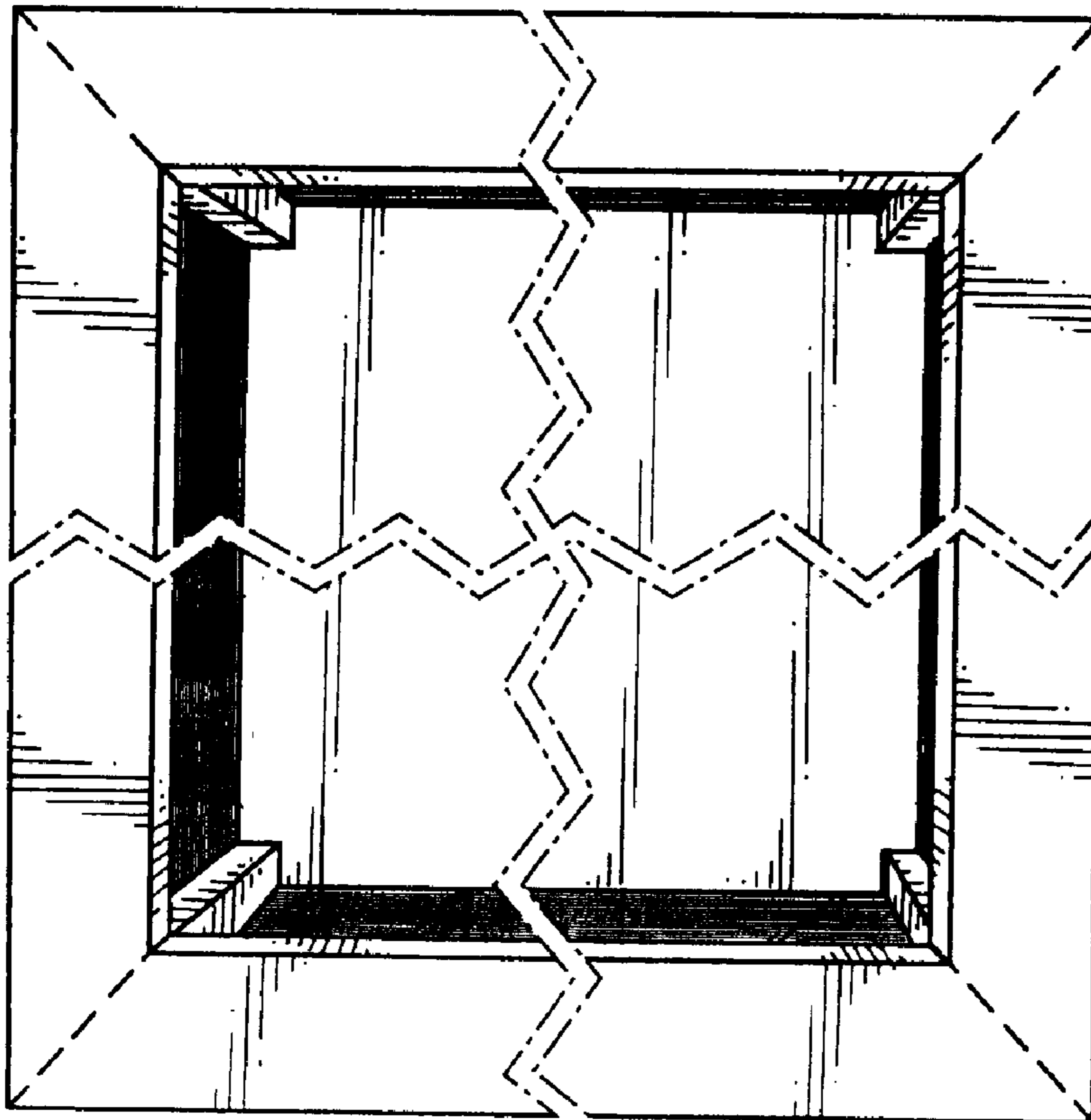
FIG. 1



**FIG.2**

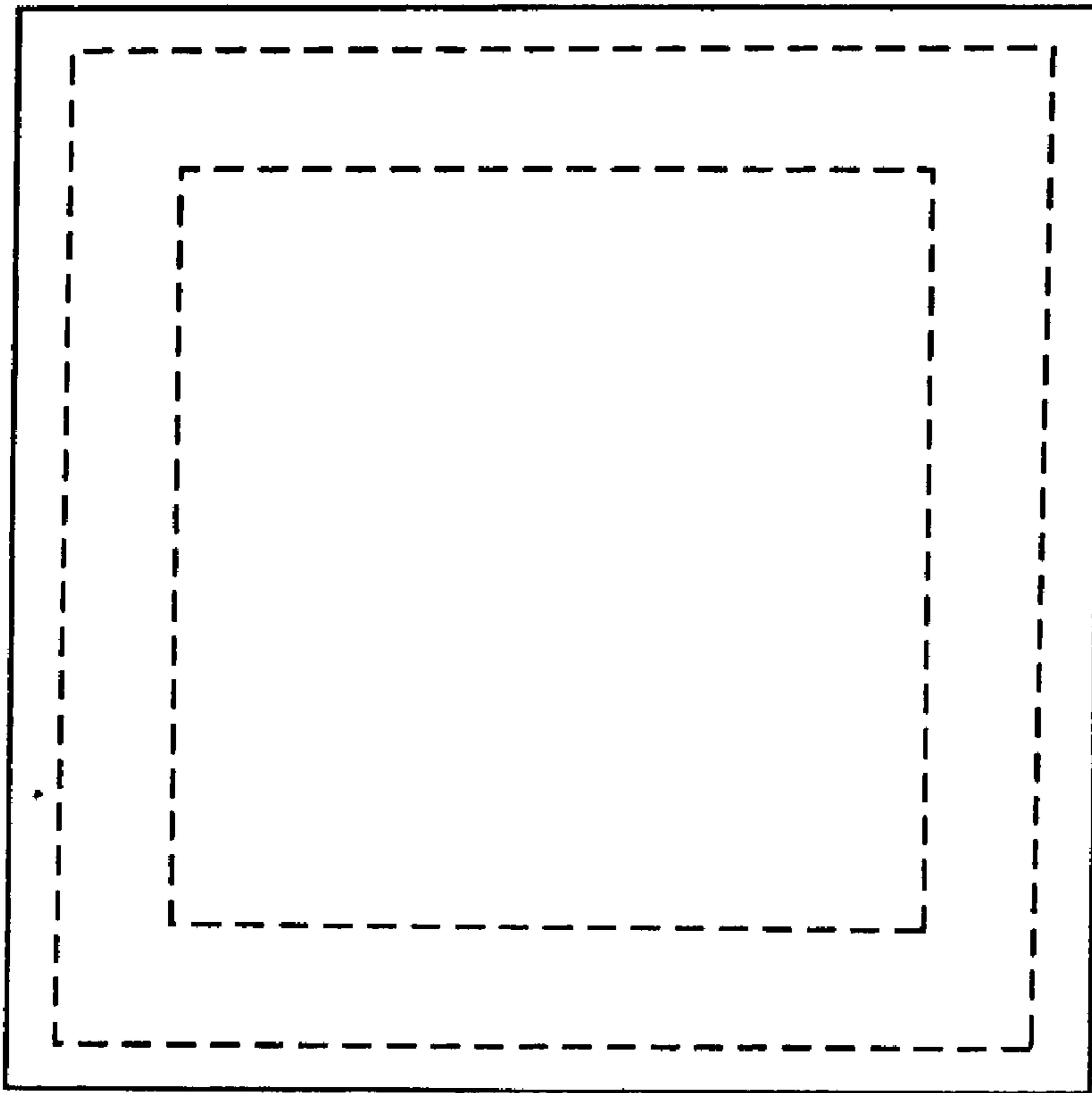


**FIG.3**

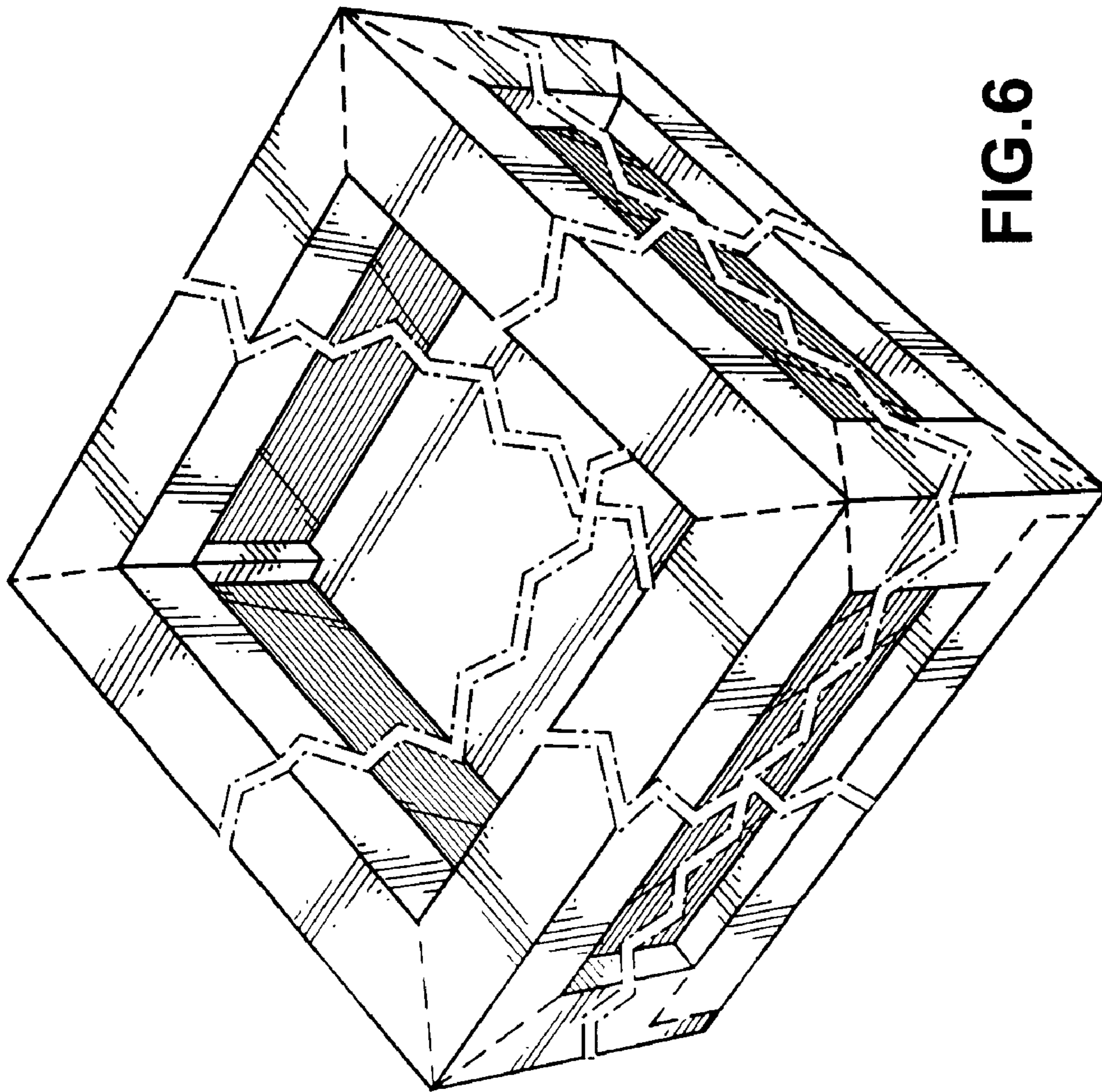


**FIG.4**





**FIG. 5**



**FIG.6**

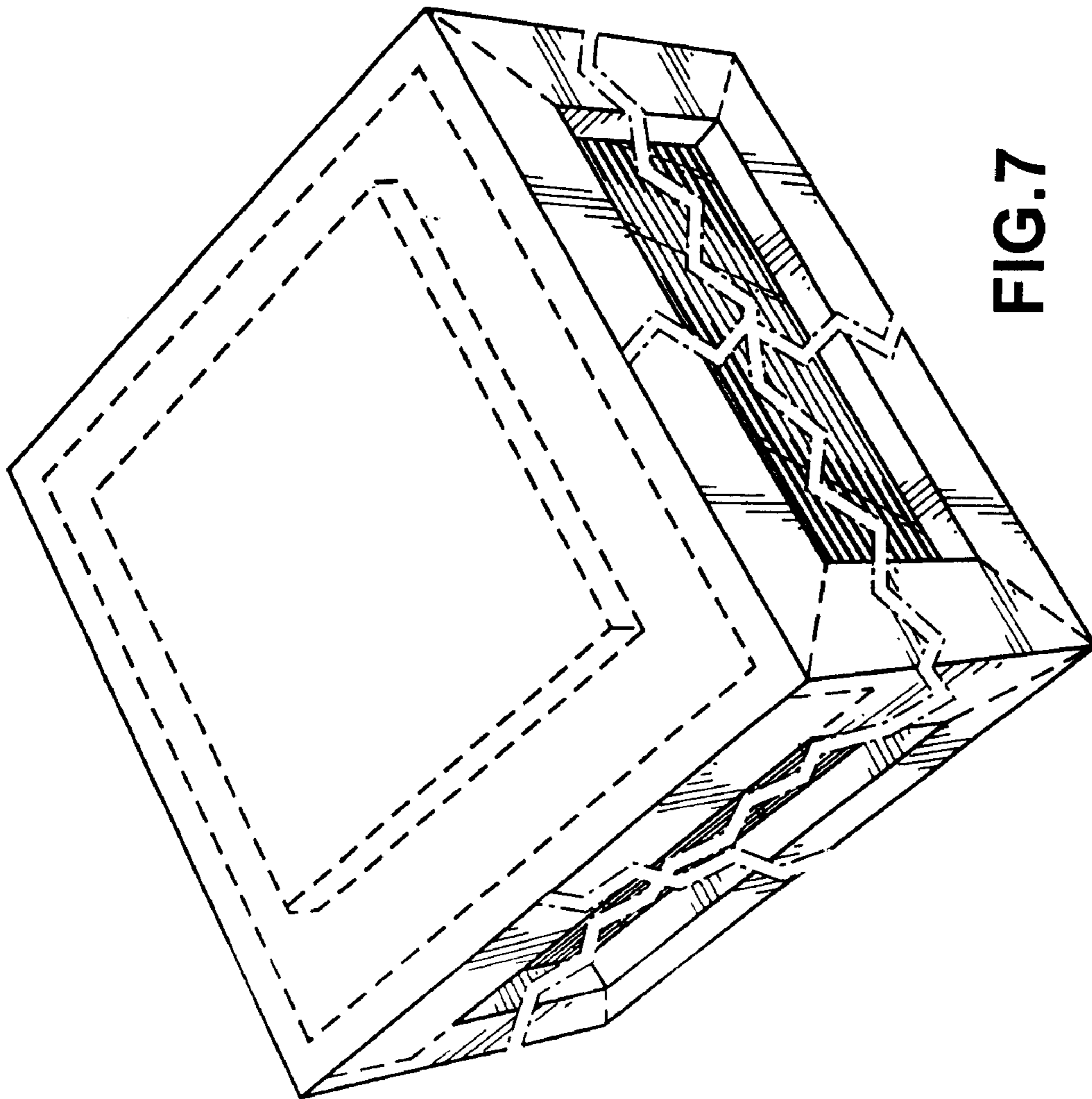
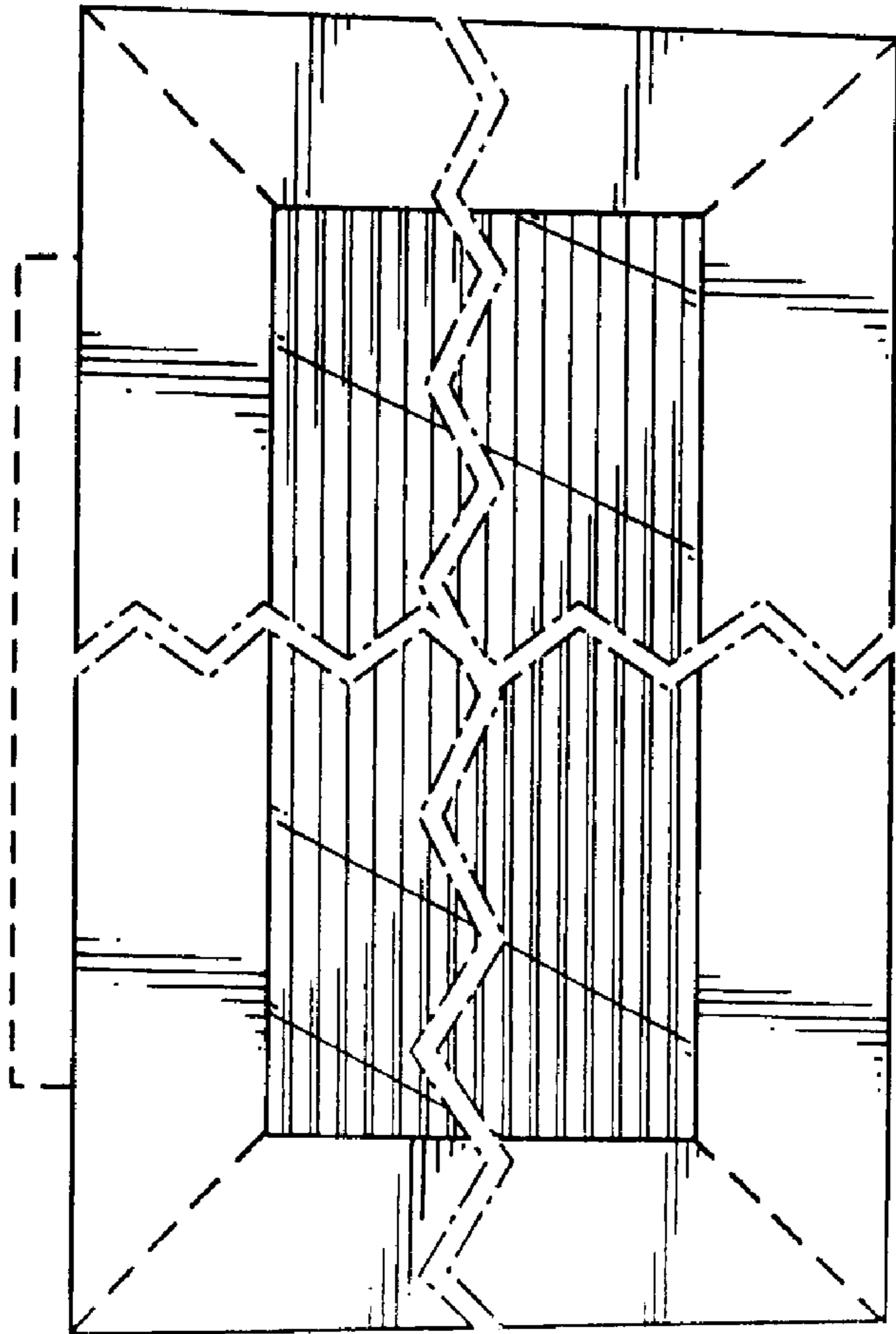
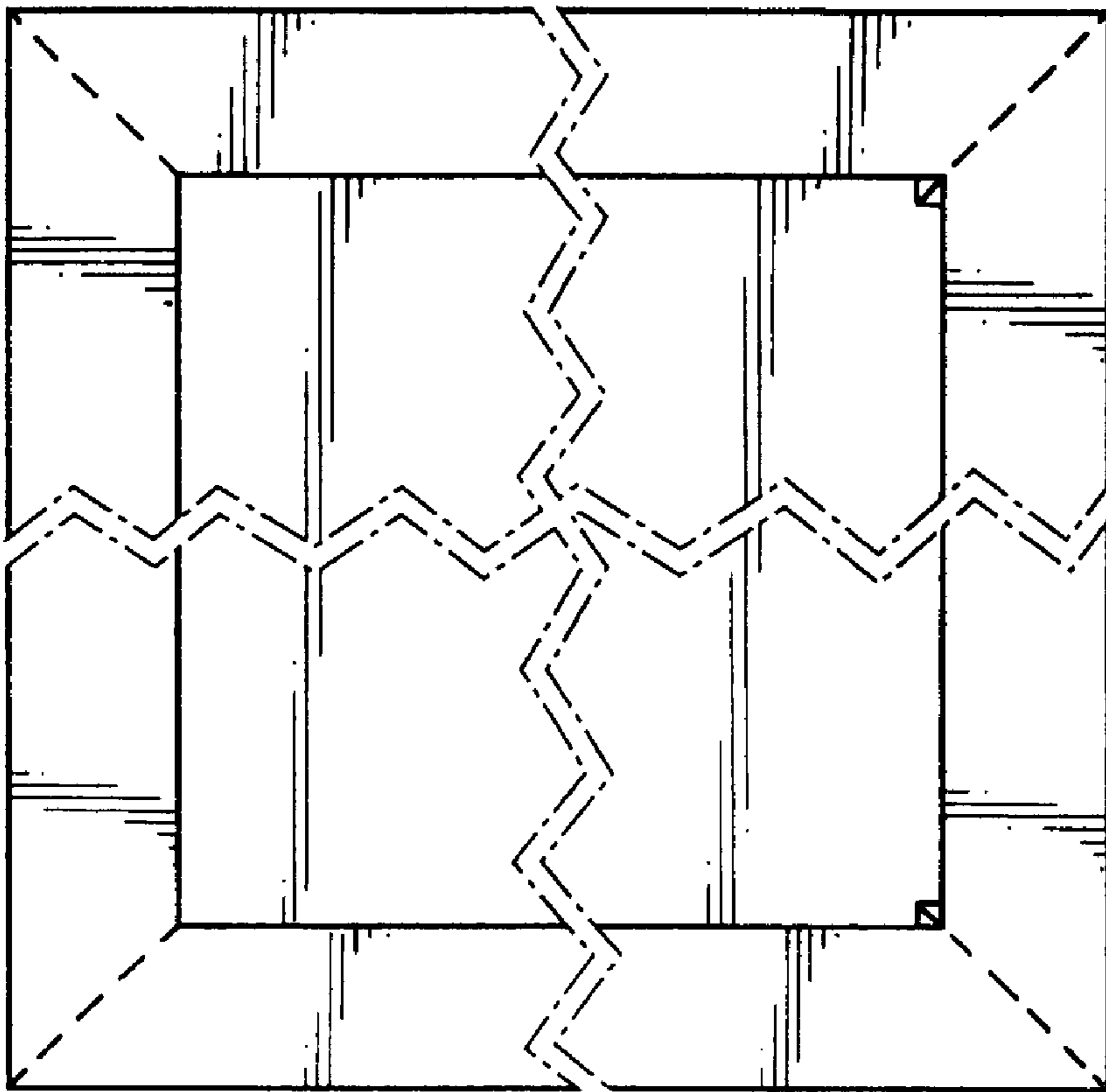


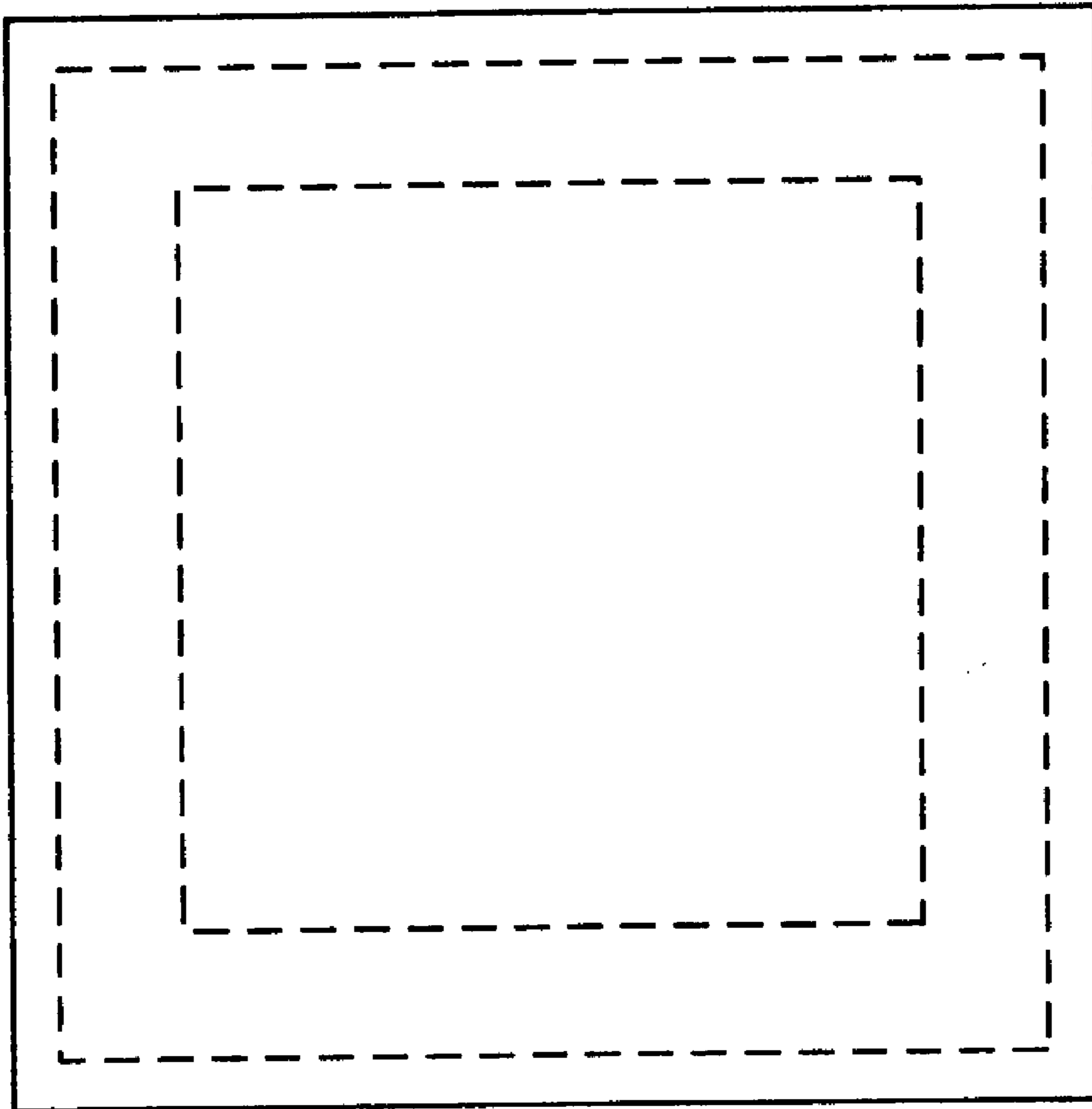
FIG. 7



**FIG.8**



**FIG. 9**



**FIG.10**

UNITED STATES PATENT AND TRADEMARK OFFICE  
**CERTIFICATE OF CORRECTION**

PATENT NO. : Des. 495,368 S  
APPLICATION NO. : 29/173224  
DATED : August 31, 2004  
INVENTOR(S) : Christopher Hardy

Page 1 of 12

It is certified that error appears in the above-identified patent and that said Letters Patent is hereby corrected as shown below:

Delete the title page and replace with the attached title page.

Delete Drawing Sheets consisting of FIGS. 1-10 and replace with the following attached drawings.

Title page,


Item [56], **References Cited**, OTHER PUBLICATIONS, insert

-- 2000 Design Ideas Catalogue, cover page and Candle Light pages #1 - #3 --.

This certificate supersedes Certificate of Correction February 21, 2006.

Signed and Sealed this

Eleventh Day of July, 2006

A handwritten signature in black ink on a light gray dotted background. The signature reads "Jon W. Dudas" in a cursive style.

JON W. DUDAS

*Director of the United States Patent and Trademark Office*

(12) **United States Design Patent** (10) **Patent No.:** **US D495,368 S**  
**Hardy** (45) **Date of Patent:** **\*\* Aug. 31, 2004**

(54) **PORTION OF AN ORGANIZER CUP**

(75) **Inventor:** **Christopher Hardy**, Springfield, IL (US)

(73) **Assignee:** **Design Ideas, Ltd.**, Springfield, IL (US)

(\*\*) **Term:** **14 Years**

(21) **Appl. No.:** **29/173,224**

(22) **Filed:** **Dec. 23, 2002**

(51) **LOC (7) Cl.** ..... **19-06**

(52) **U.S. Cl.** ..... **D19/77; D19/85; D19/75; D7/641**

(58) **Field of Search** ..... **D19/65, 75, 77, D19/78, 81-85, 95, 99, 100; 206/214, 224, 371; 211/69.1-69.9, 13.1; D7/641; D3/206, 306; D11/155; 40/720**

(56) **References Cited**

**U.S. PATENT DOCUMENTS**

3,716,936 A	*	2/1973	Miller	40/720
3,771,246 A	*	11/1973	Ebner	40/720
D234,530 S	*	3/1975	Waltzman	D11/155
4,195,729 A	*	4/1980	Macken	40/720 X
D326,113 S	*	5/1992	Galante	D19/78
D329,663 S	*	9/1992	Galante	D19/78
5,487,466 A	*	1/1996	Robson	206/214
5,816,416 A	*	10/1998	Tsai	211/69.1
D431,907 S	*	10/2000	Andujar et al.	D3/306
D436,626 S	*	1/2001	Wang	D19/85
D444,177 S	*	6/2001	Carretta	D19/85

**OTHER PUBLICATIONS**

Staples Catalogue, 2003 line of Expressions Punched Metal and Wood desk set and Mahogany Finish Wood desk set, pp. 1 and 2 in color, Oct. 2002.

\* cited by examiner

*Primary Examiner*—Martie K. Holtje

(74) *Attorney, Agent, or Firm*—SAIDMAN DesignLaw Group

(57) **CLAIM**

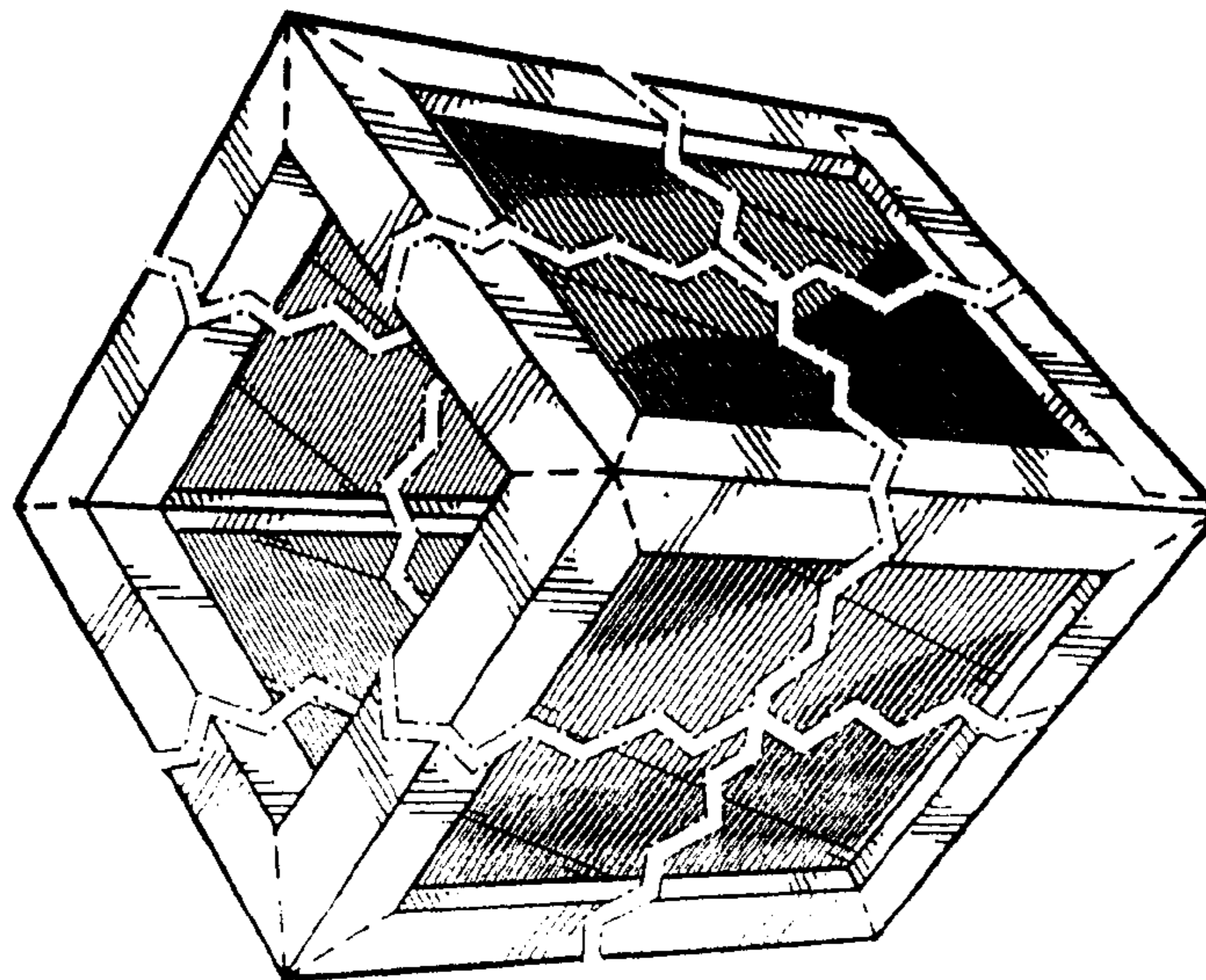
The ornamental design for a portion of an organizer cup, as shown and described.

**DESCRIPTION**

FIG. 1 is a top, perspective view of a first embodiment of a portion of an organizer cup showing my new design; FIG. 2 is a bottom, perspective view thereof; FIG. 3 is a side, perspective view thereof, the three remaining side, perspective views being identical; FIG. 4 is a top, perspective view thereof; FIG. 5 is a bottom view thereof; FIG. 6 is a top, perspective view of a second embodiment of a portion of an organizer cup showing my new design; FIG. 7 is a bottom, perspective view thereof; FIG. 8 is a side view thereof, the three remaining side views being duplicates; FIG. 9 is a top, perspective view thereof; and, FIG. 10 is a bottom view thereof.

The broken lines in the drawings form no part of the claimed design. The jagged broken lines in the drawings form no part of the claimed design and the subject matter between such jagged lines is broken away to disclose indeterminate length.

**1 Claim, 10 Drawing Sheets**





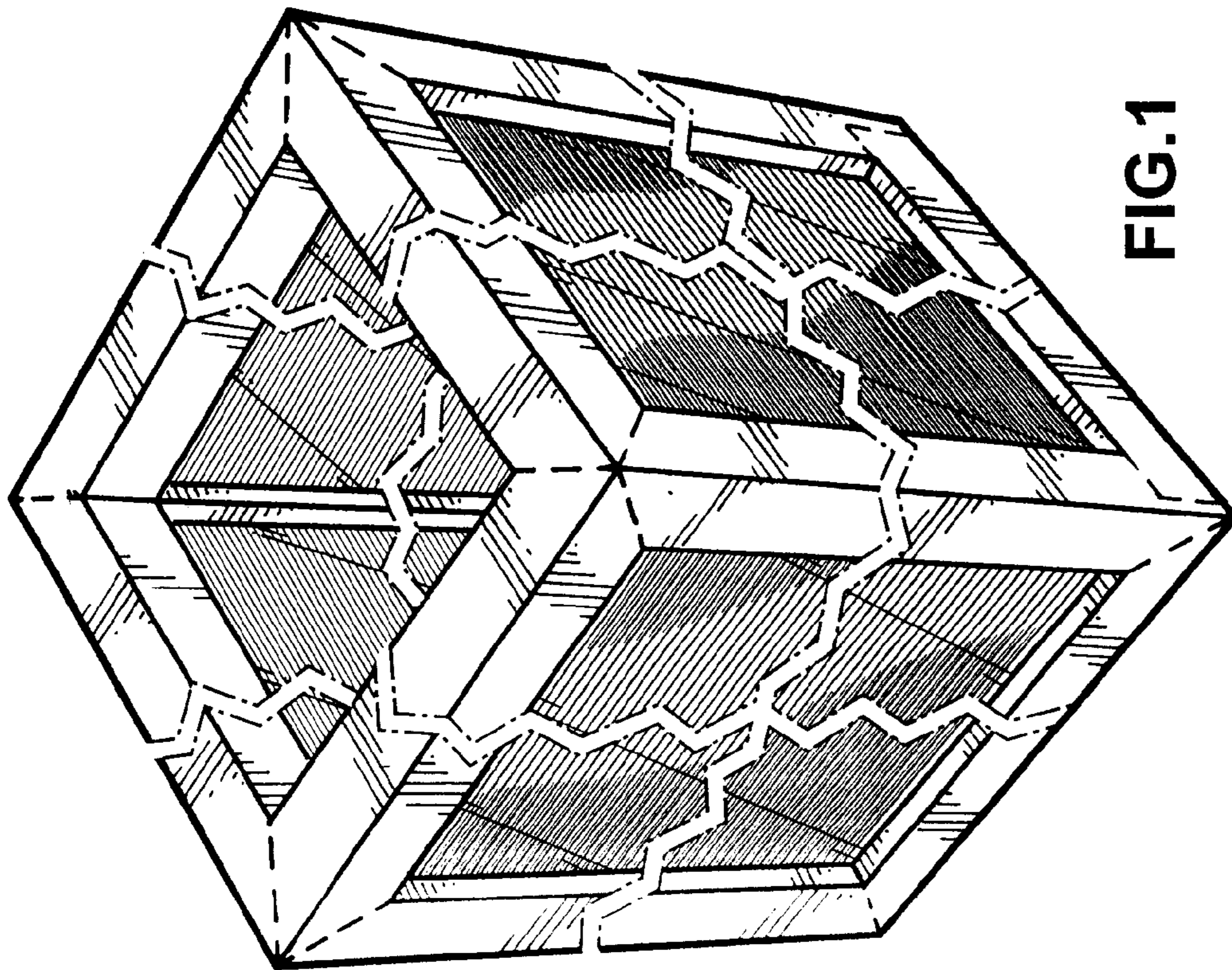


FIG. 1

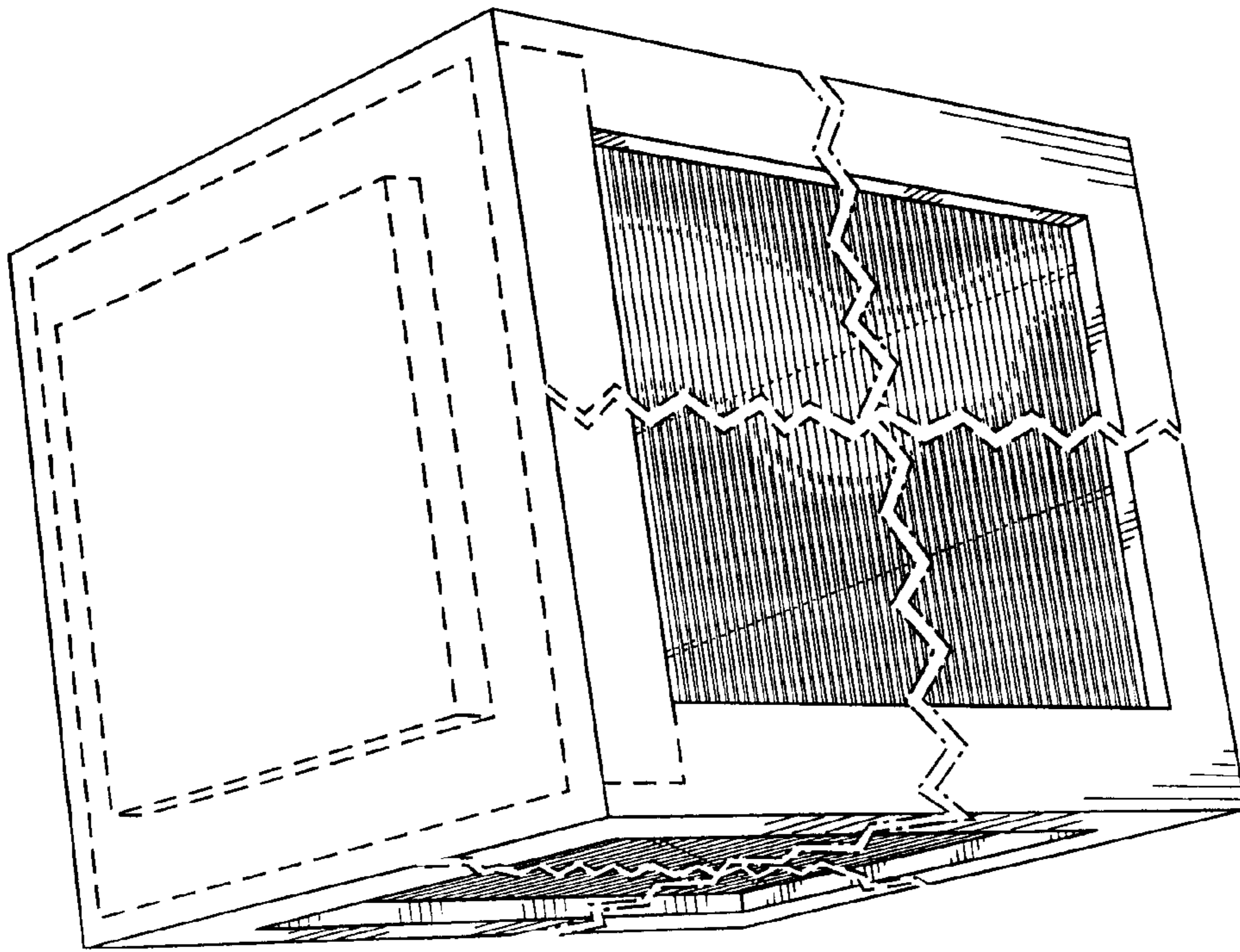
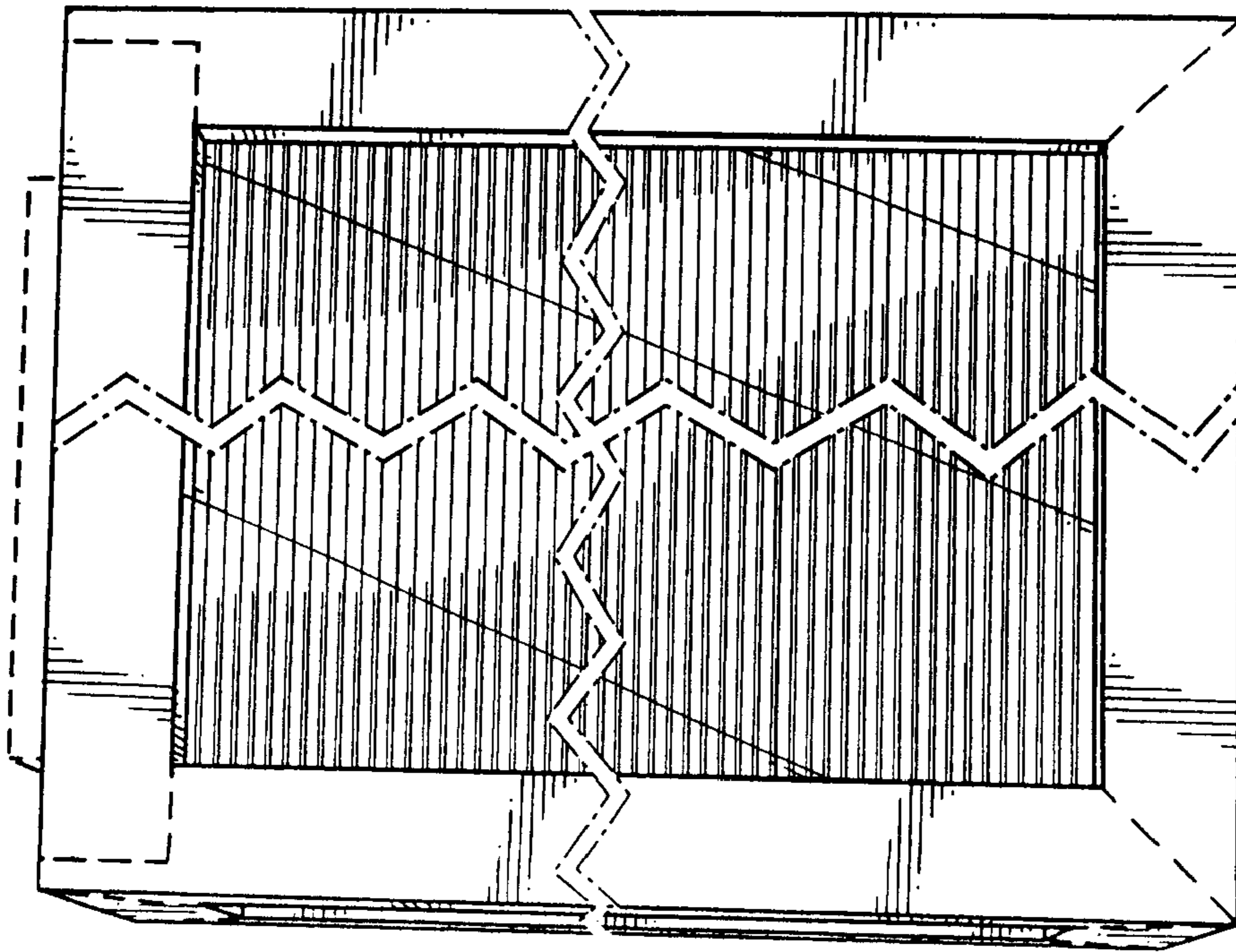
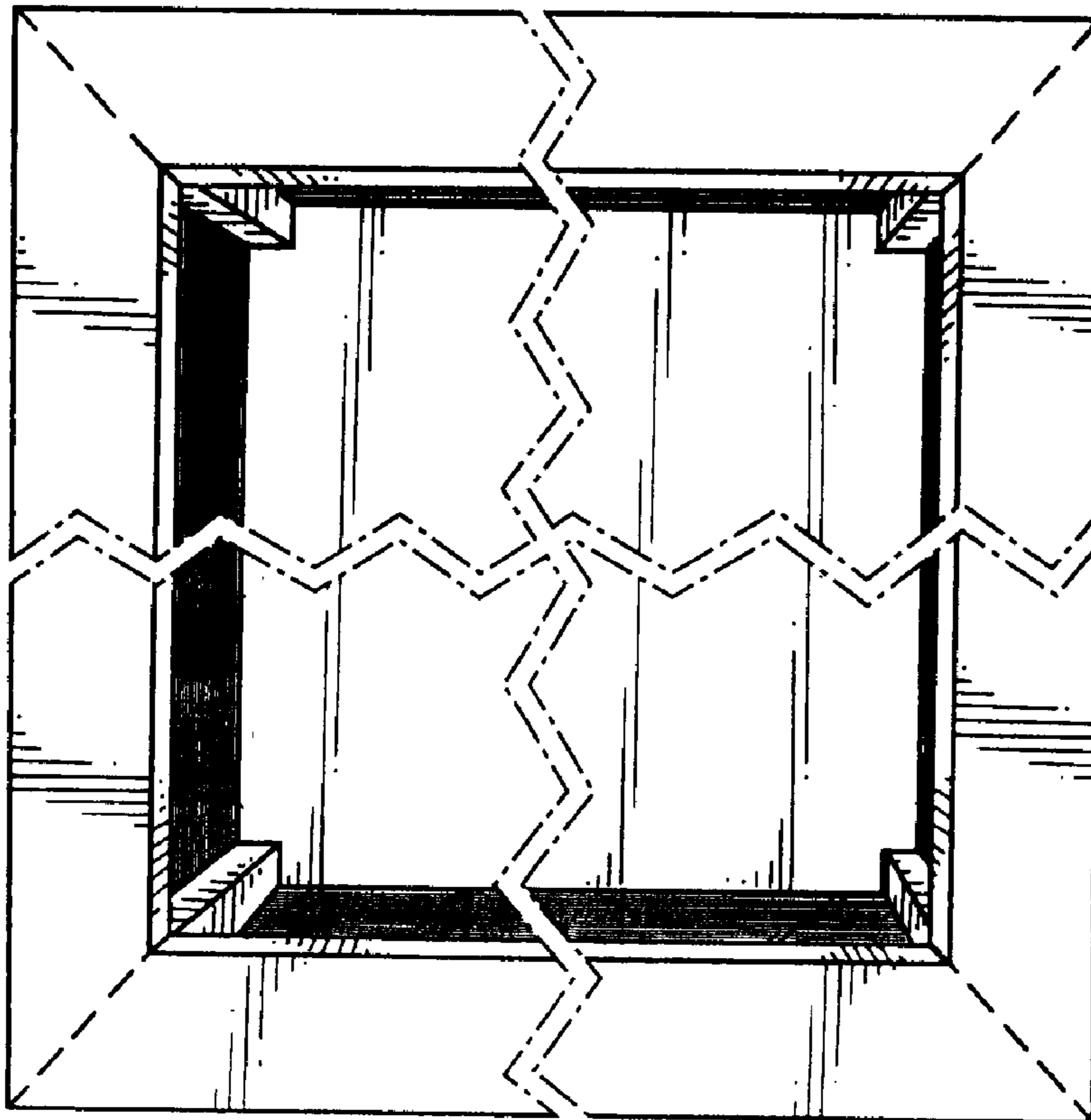


FIG.2



**FIG.3**



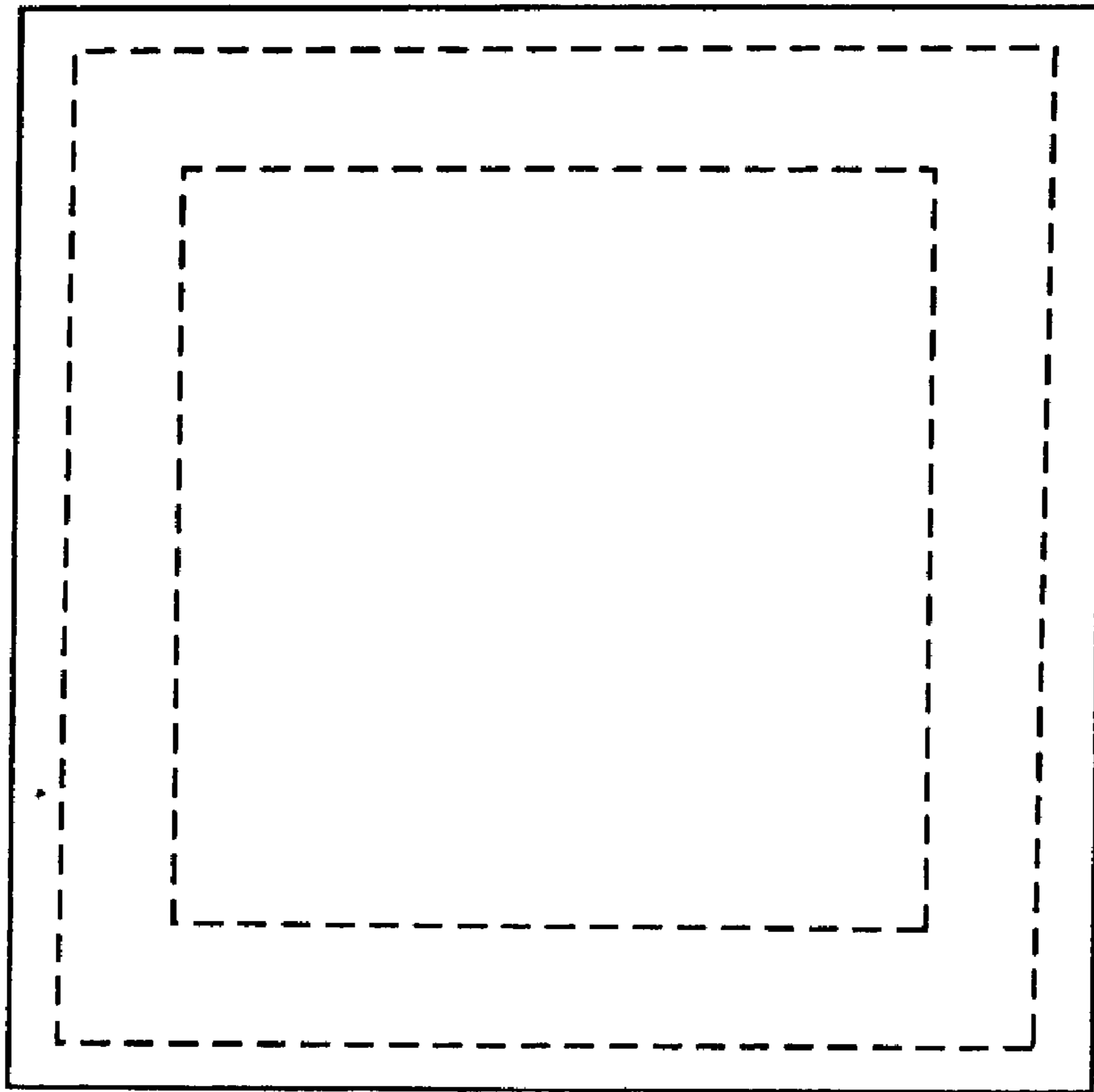
**FIG.4**

**U.S. Patent**

**Aug. 31, 2004**

**Sheet 5 of 10**

**D495,368 S**



**FIG. 5**

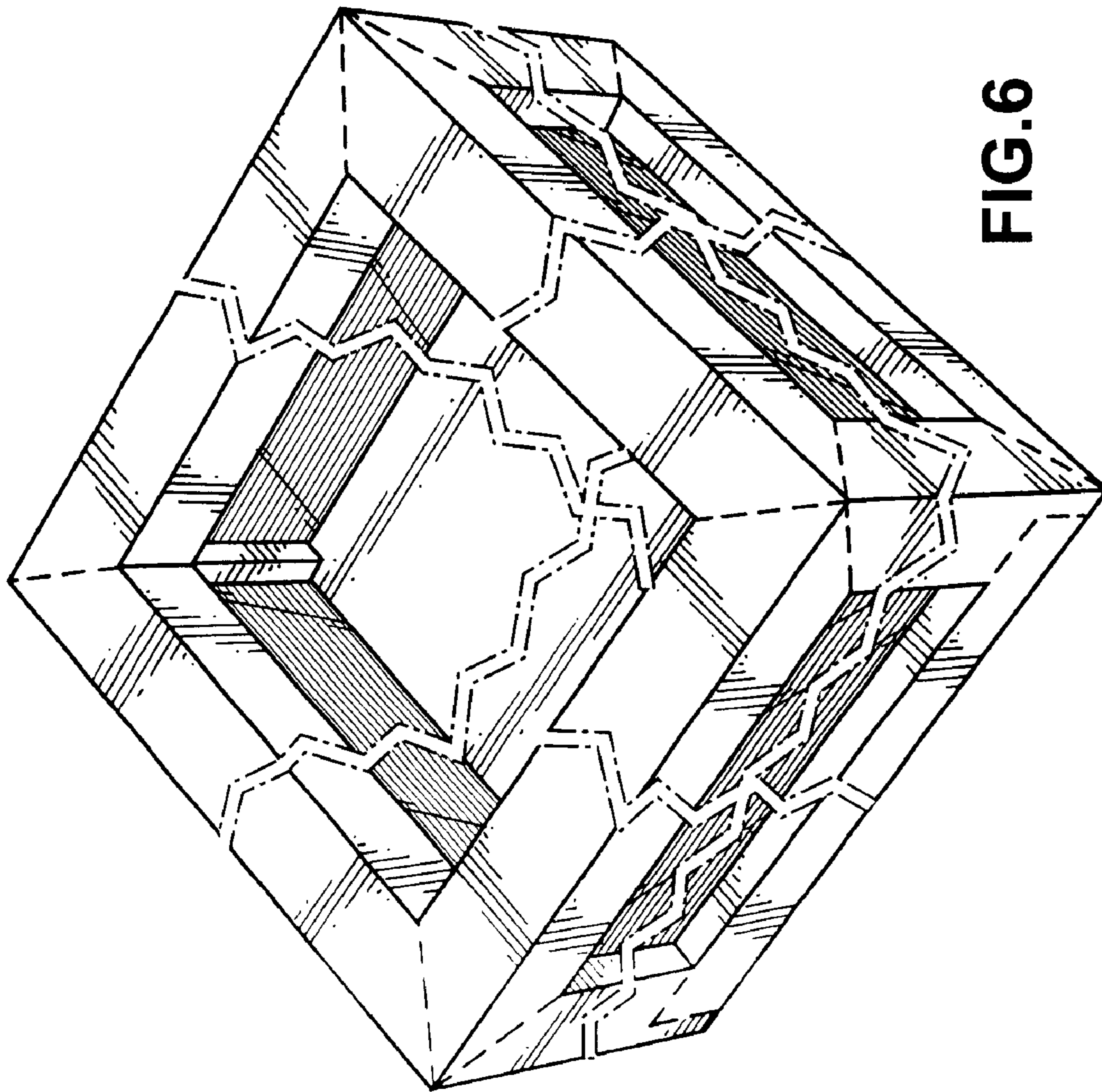


FIG. 6

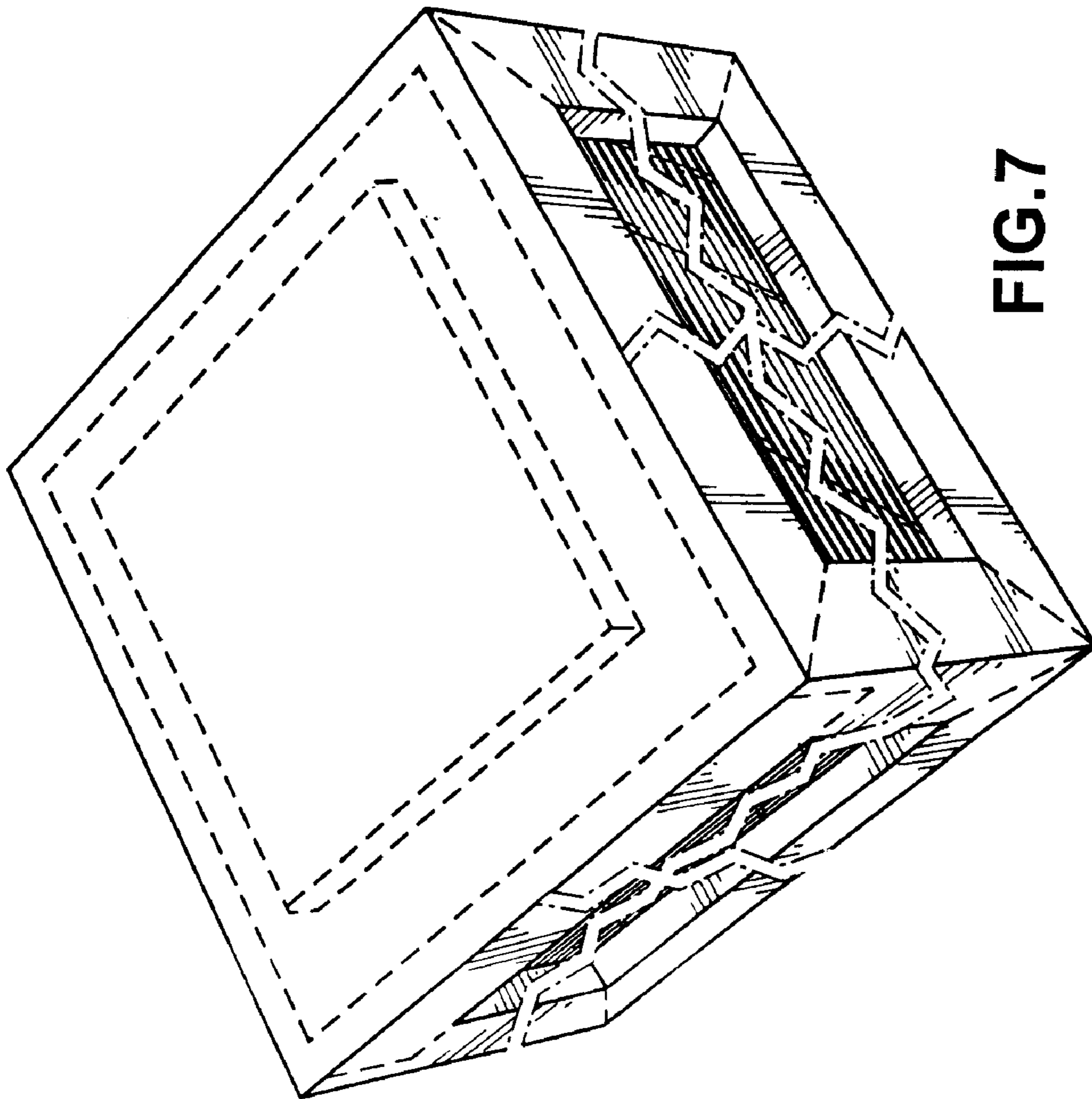


FIG.7

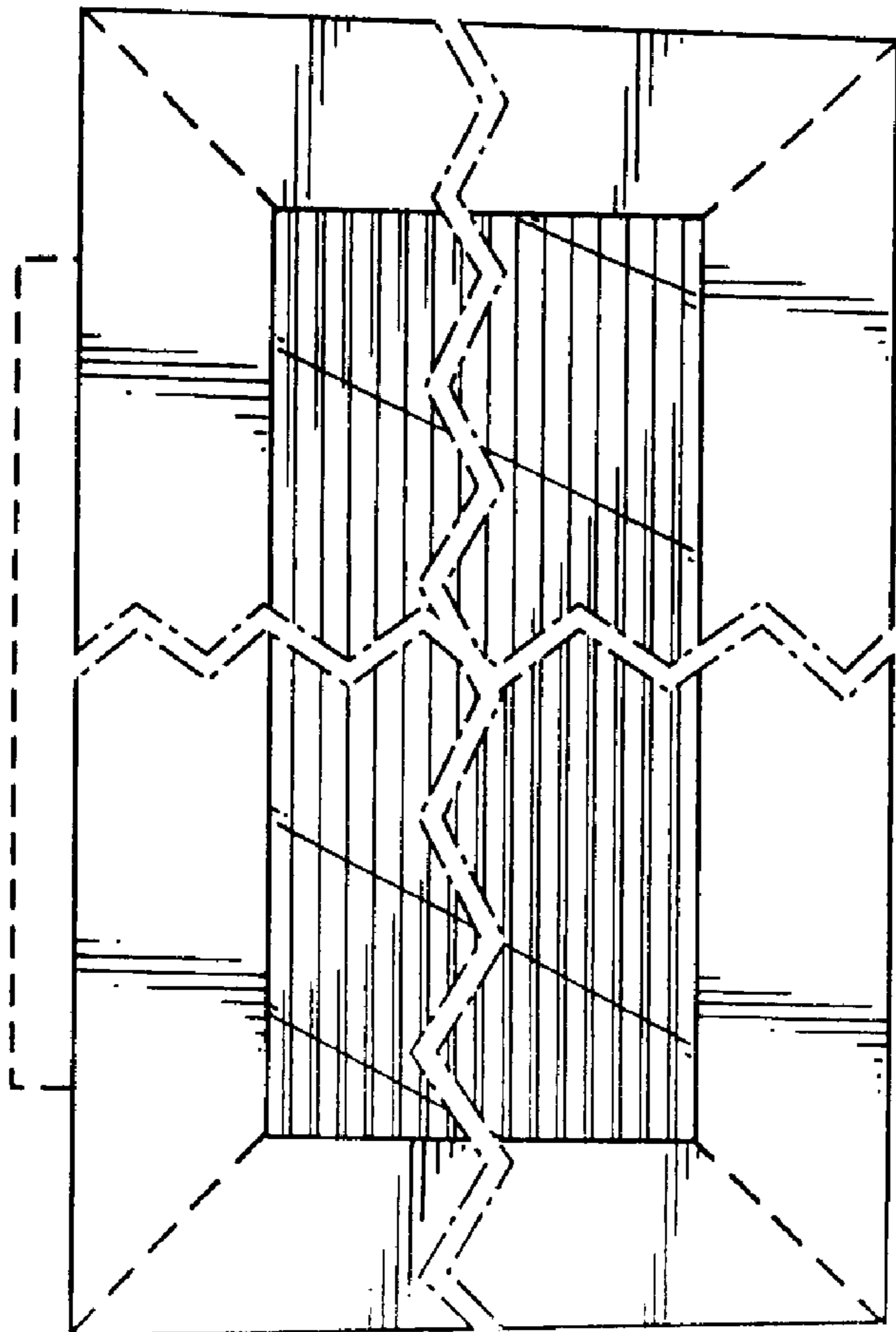
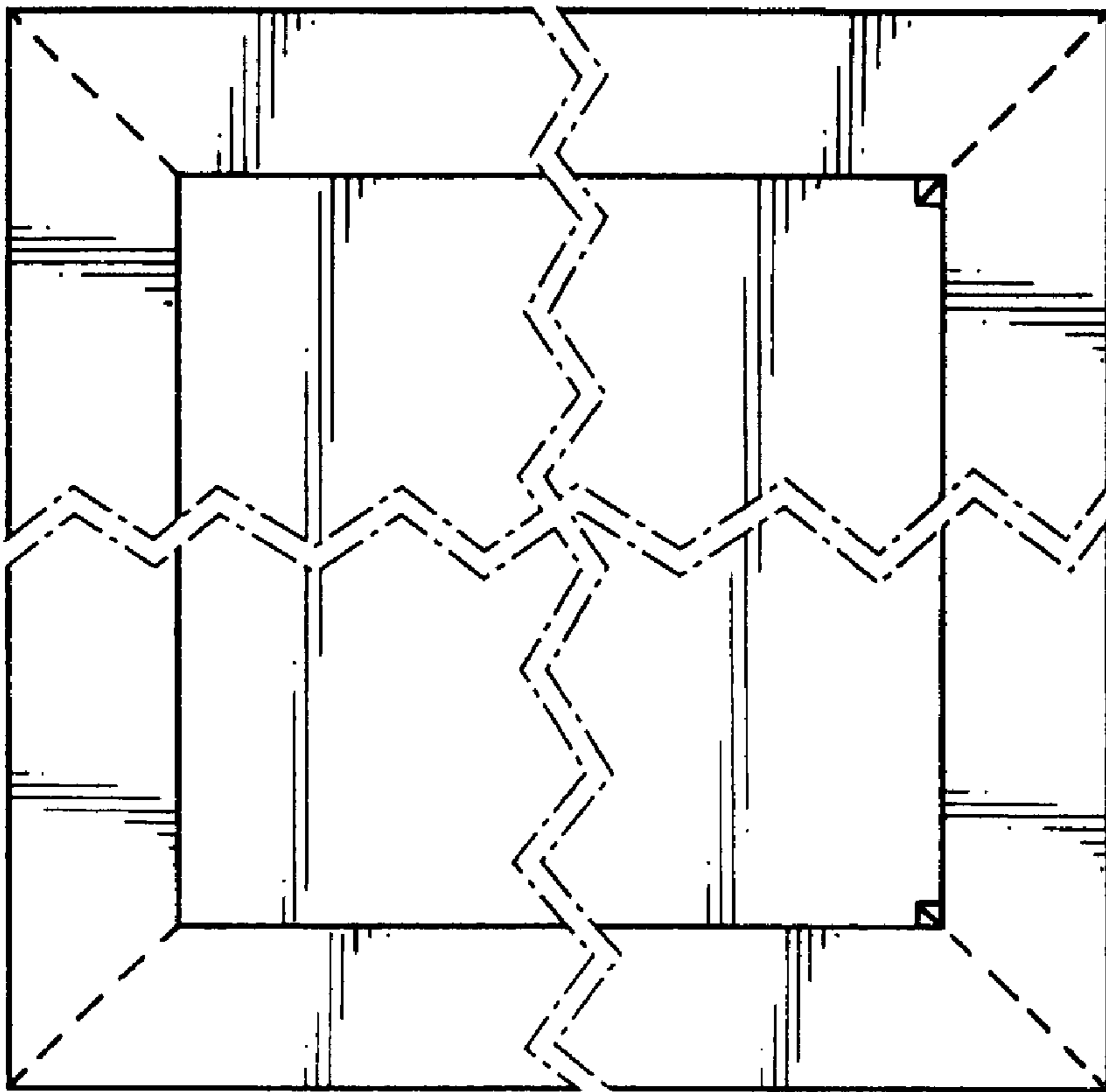
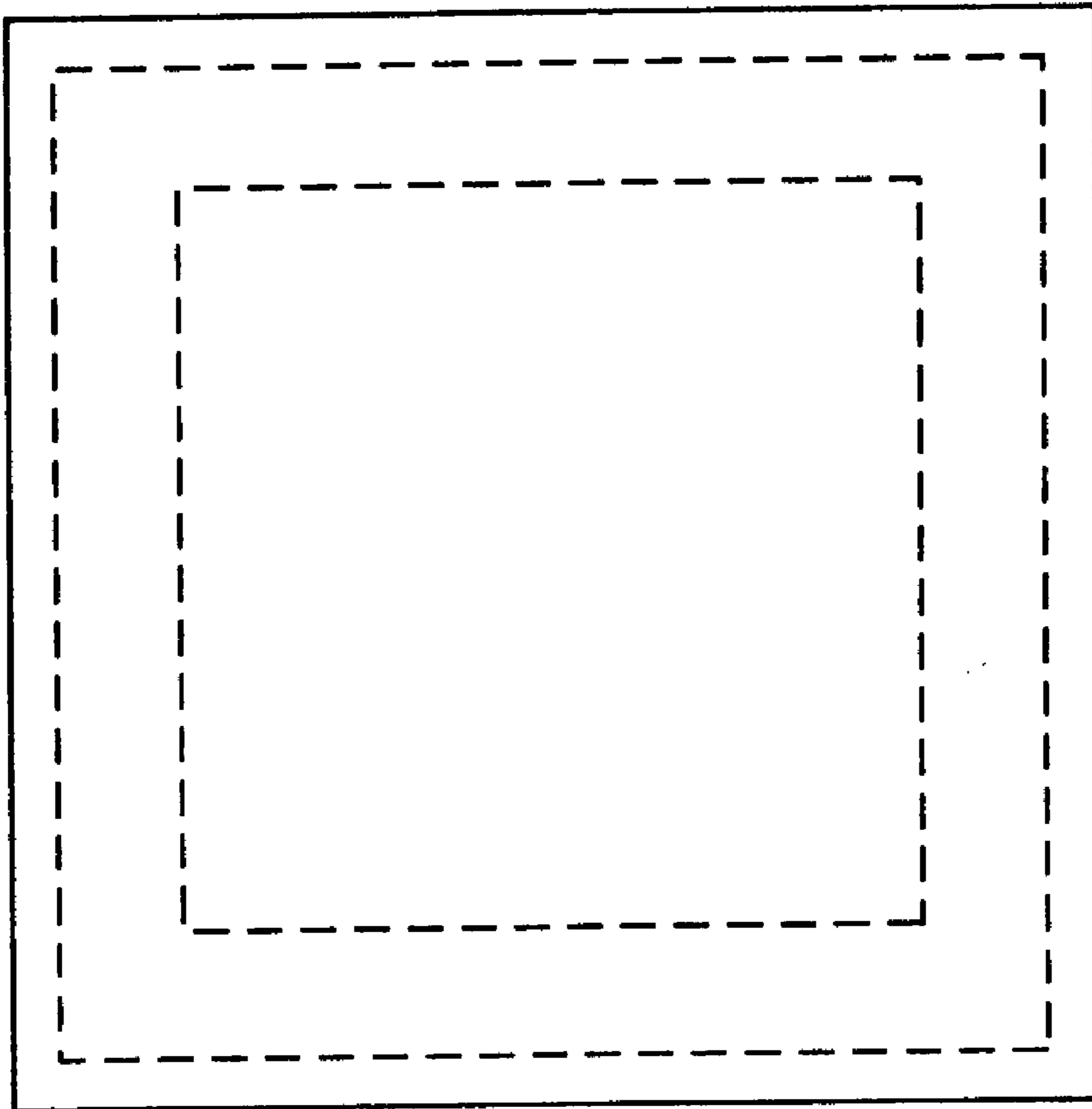


FIG.8





**FIG. 9**



**FIG.10**