



US00D495349S1

(12) **United States Design Patent** (10) **Patent No.:** **US D495,349 S**
Zilka et al. (45) **Date of Patent:** **** Aug. 31, 2004**

(54) **CONTAINER FOR METAL COIL**

(76) Inventors: **Michael G. Zilka**, 283 Beacon Rd.,
Renfrew, PA (US) 15063; **Mitchel S.**
Rea, 390 Glendale Rd., Beaver Falls,
PA (US) 15010

(**) Term: **14 Years**

(21) Appl. No.: **29/188,304**

(22) Filed: **Aug. 15, 2003**

(51) **LOC (7) Cl.** **15-99**

(52) **U.S. Cl.** **D15/199**

(58) **Field of Search** D15/199; 206/397,
206/402, 303, 407-409, 394; 24/299, 370;
53/436, 526

(56) **References Cited**

U.S. PATENT DOCUMENTS

1,564,472 A	12/1925	Daly et al.
1,665,238 A	4/1928	Turan
1,826,084 A	10/1931	Mohr
2,352,192 A	6/1944	Gasche
3,043,354 A	7/1962	Fitzgerald
3,128,002 A	4/1964	Buchanan
3,485,408 A	12/1969	Benesch
3,515,269 A	6/1970	Furtado
3,693,784 A	9/1972	Holmes

(List continued on next page.)

Primary Examiner—Antoine D. Davis

(74) *Attorney, Agent, or Firm*—Kirkpatrick & Lockhart
LLP

(57) **CLAIM**

The ornamental design for a container for metal coil, as
shown and described.

DESCRIPTION

FIG. 1 is a perspective view of a container for metal coil
showing our new design;

FIG. 2 is a front view of the container for metal coil;
 FIG. 3 is a rear view of the container for metal coil;
 FIG. 4 is a top elevational view of the container for metal
 coil;
 FIG. 5 is a bottom view of the container for metal coil;
 FIG. 6 is a left side view of the container for metal coil;
 FIG. 7 is a right side view of the container for metal coil;
 FIG. 8 is a perspective view of a second embodiment of a
 container for metal coil;
 FIG. 9 is a front view of the second embodiment of a
 container for metal coil;
 FIG. 10 is a rear view of the second embodiment of a
 container for metal coil;
 FIG. 11 is a top elevational view of the second embodiment
 of a container for metal coil;
 FIG. 12 is a bottom view of the second embodiment of a
 container for metal coil;
 FIG. 13 is a left side view of the second embodiment of a
 container for metal coil;
 FIG. 14 is a right side view of the second embodiment of a
 container for metal coil;
 FIG. 15 is a top elevational view of one interior configura-
 tion of the open container for metal coil shown in FIGS.
 8-14;
 FIG. 16 is a top elevational view of another interior con-
 figuration of the open container for metal coil shown in
 FIGS. 8-14;
 FIG. 17 is a top elevational view of yet another interior
 configuration of the open container for metal coil shown in
 FIGS. 8-14; and,
 FIG. 18 is a top elevational view of a further interior
 configuration of the open container for metal coil shown in
 FIGS. 8-14.

1 Claim, 10 Drawing Sheets

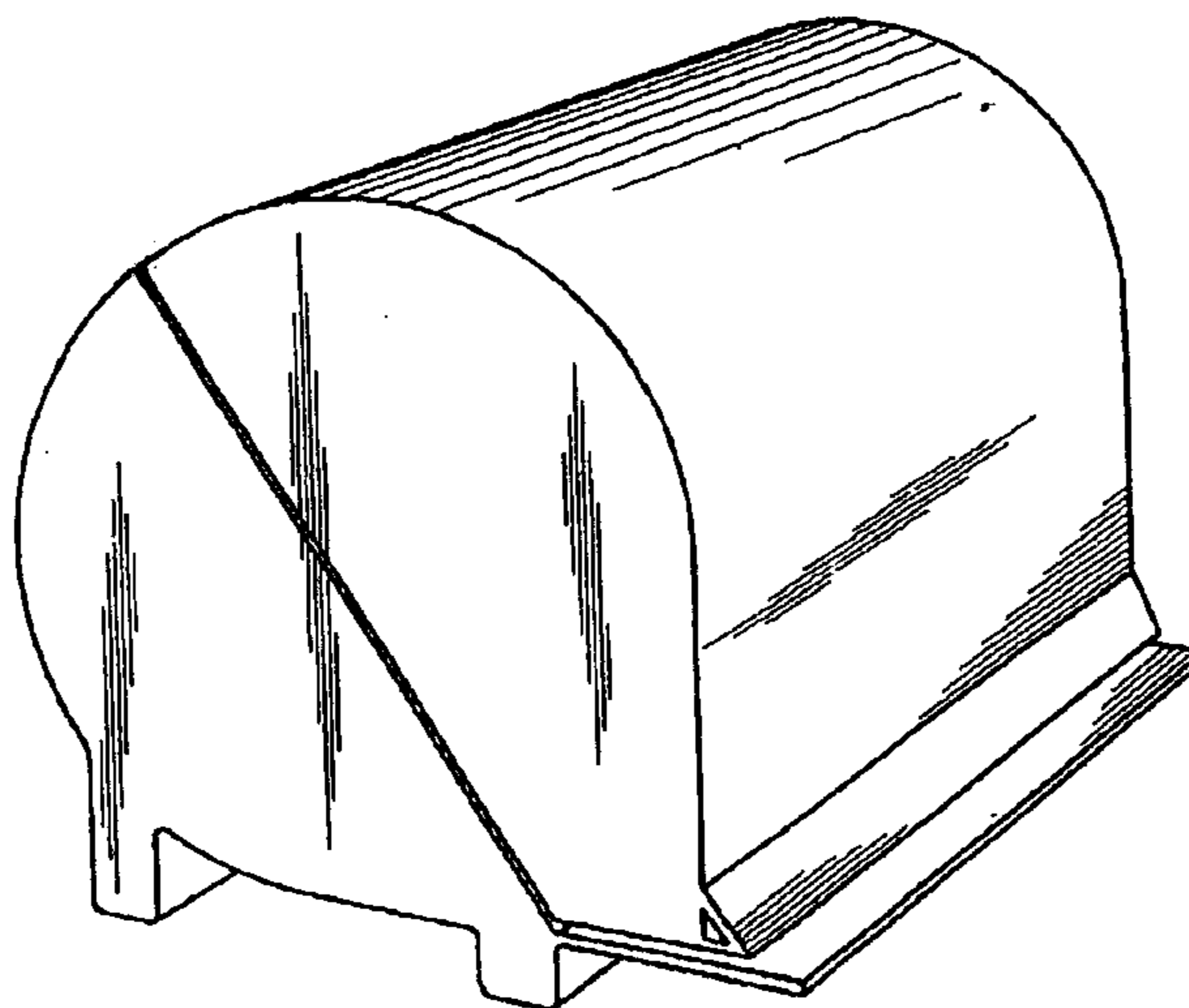

U.S. PATENT DOCUMENTS					
			4,901,855 A	2/1990	Furukawa
			5,053,811 A	10/1991	Watabe et al.
3,695,481 A	10/1972	Fostor et al.	5,111,950 A	5/1992	Wylenzek
3,782,592 A	1/1974	Bergh et al.	5,184,743 A	2/1993	Suzuki et al.
3,828,969 A	8/1974	Schurman	5,295,578 A *	3/1994	Neidospial et al. 206/408
3,843,071 A	10/1974	Graham	5,509,561 A	4/1996	Kanterovitch
4,168,778 A	9/1979	Buxton	5,593,035 A	1/1997	Taylor et al.
4,257,523 A	3/1981	Blasio	5,819,935 A	10/1998	Lawson
4,274,573 A	6/1981	Finkelstein	5,941,476 A	8/1999	Copas
4,410,084 A	10/1983	Ladner	5,979,812 A	11/1999	Kotzur et al.
4,444,313 A	4/1984	Tyson	6,003,668 A	12/1999	Joyce
4,445,645 A	5/1984	Byer	6,016,911 A	1/2000	Chen
4,659,028 A	4/1987	Wren	6,276,623 B1	8/2001	Williams
4,732,528 A	3/1988	Good	6,446,808 B1 *	9/2002	Paul et al. 206/494
4,735,342 A *	4/1988	Goldstein 221/25	6,575,397 B1 *	6/2003	Tramontina et al. 242/593
4,805,794 A	2/1989	Tsuchiya et al.			
4,811,998 A *	3/1989	Rankin 312/229			

* cited by examiner

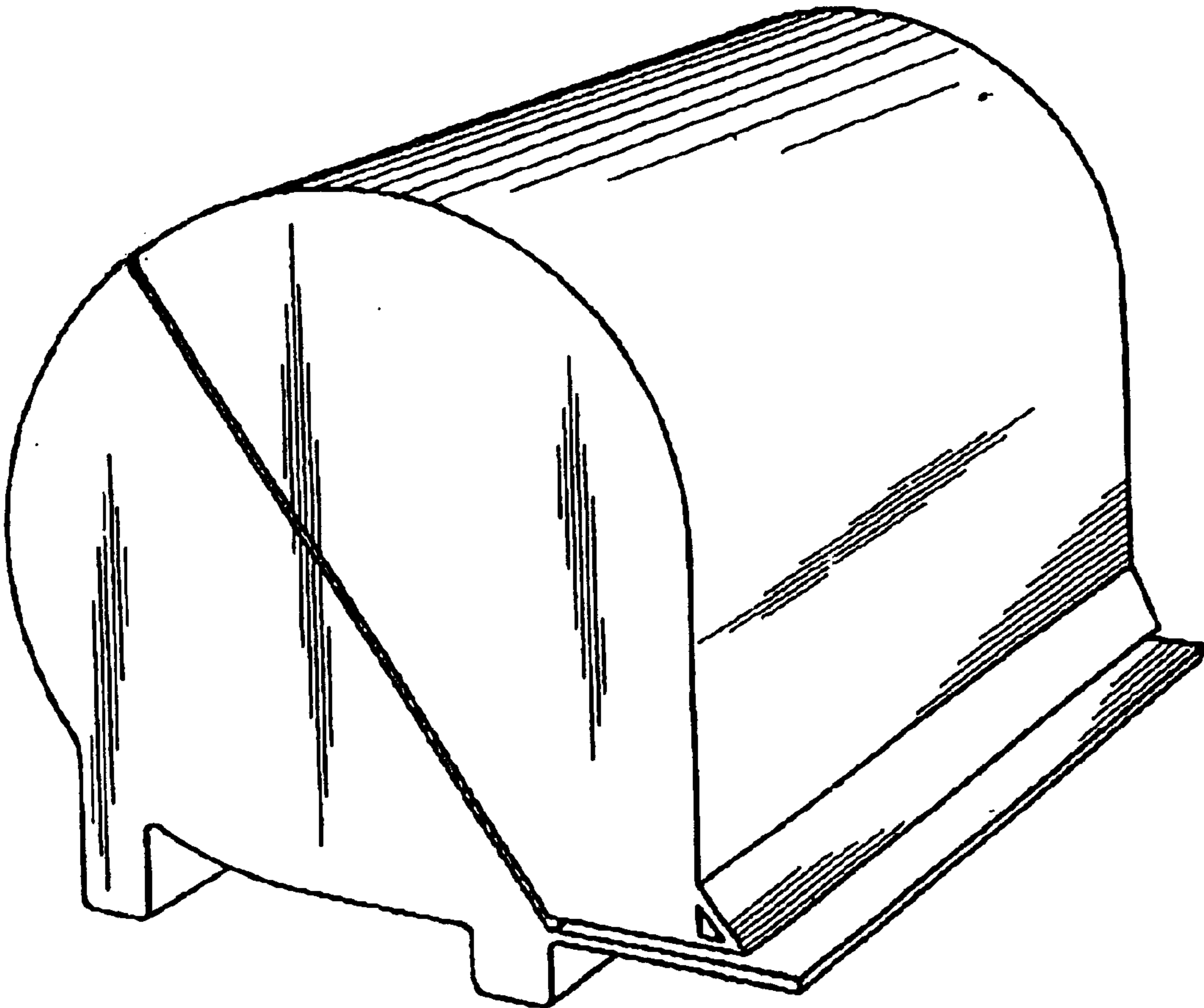

Fig.1

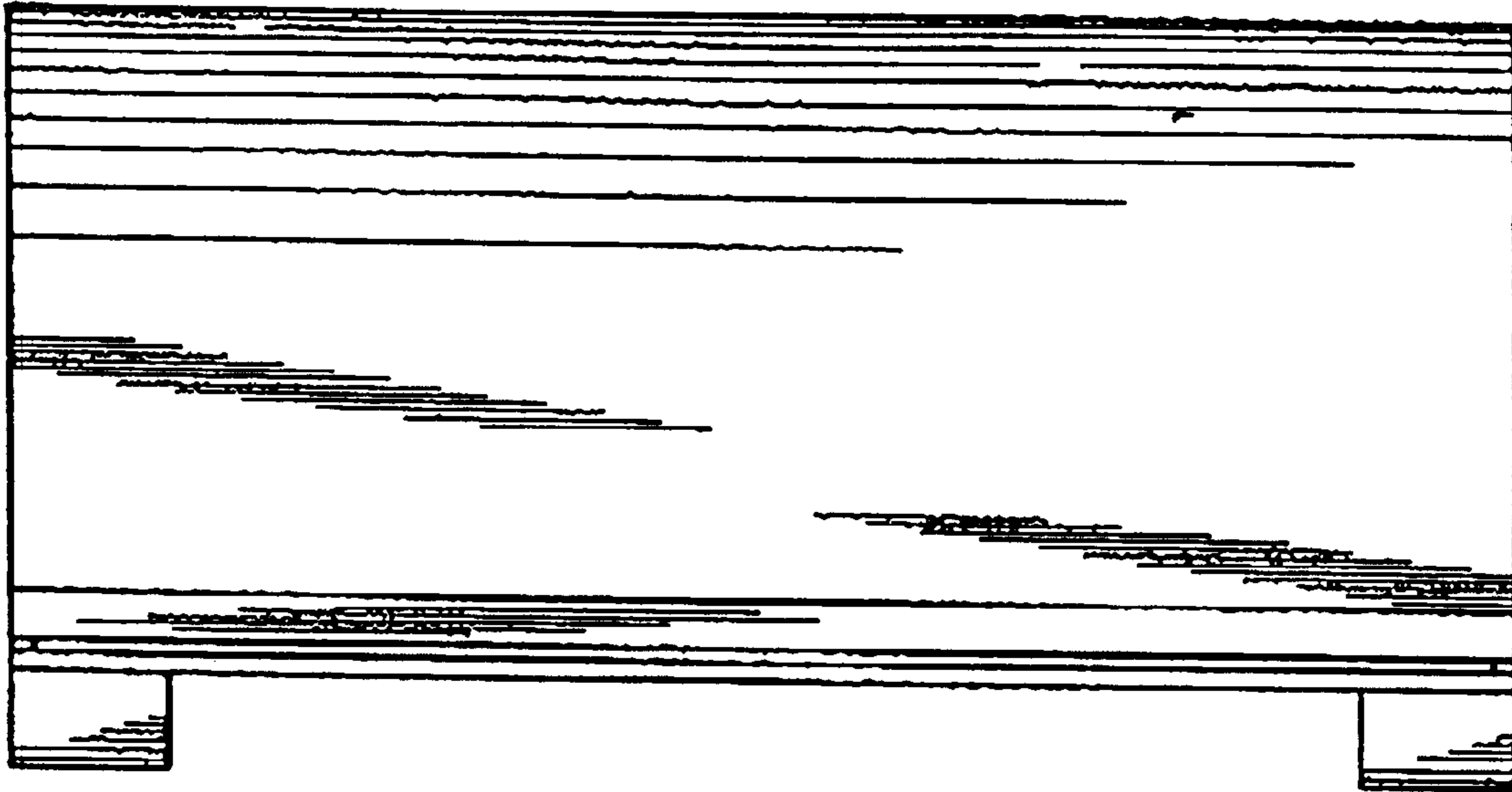

Fig. 2

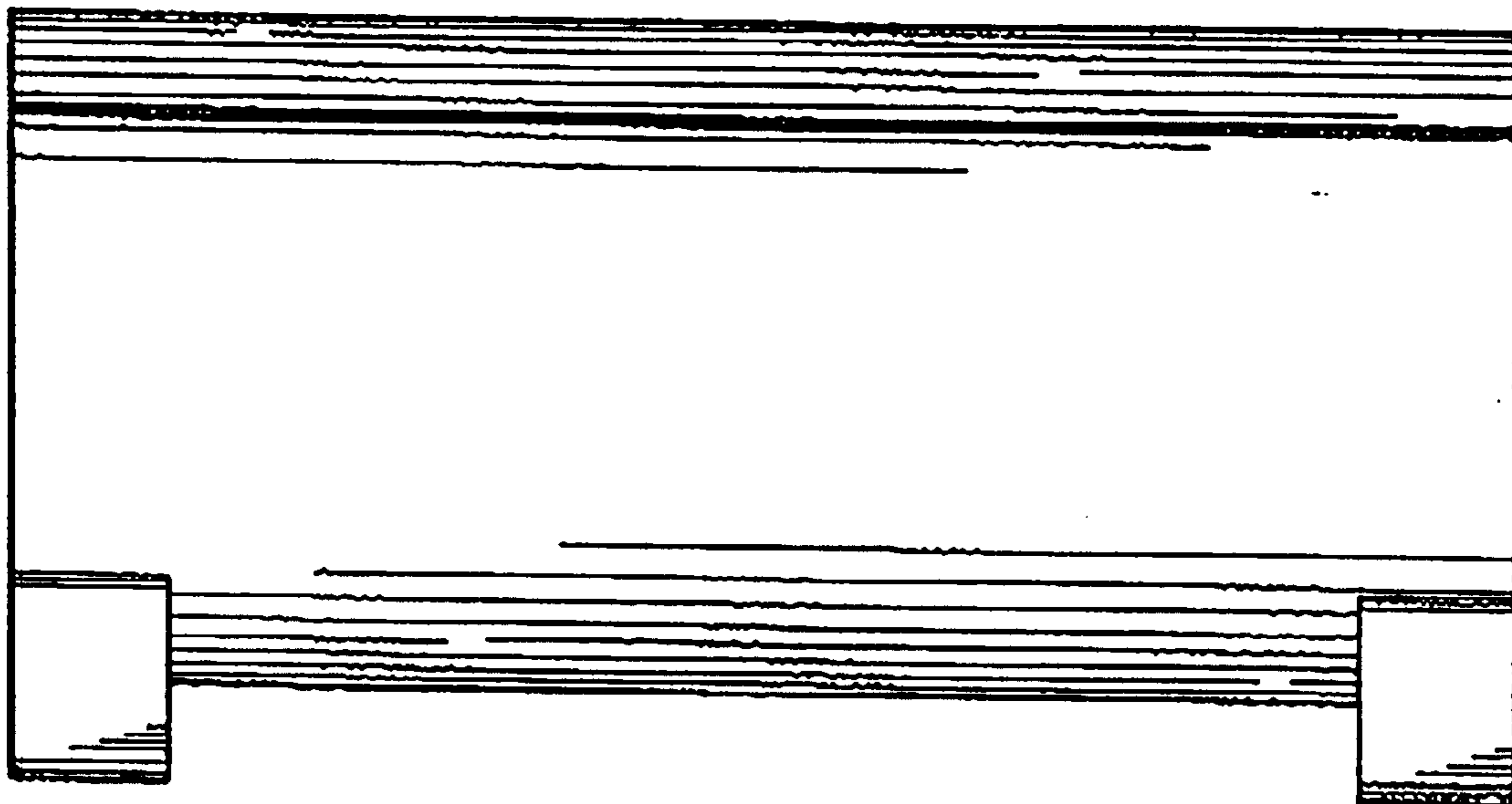

Fig. 3

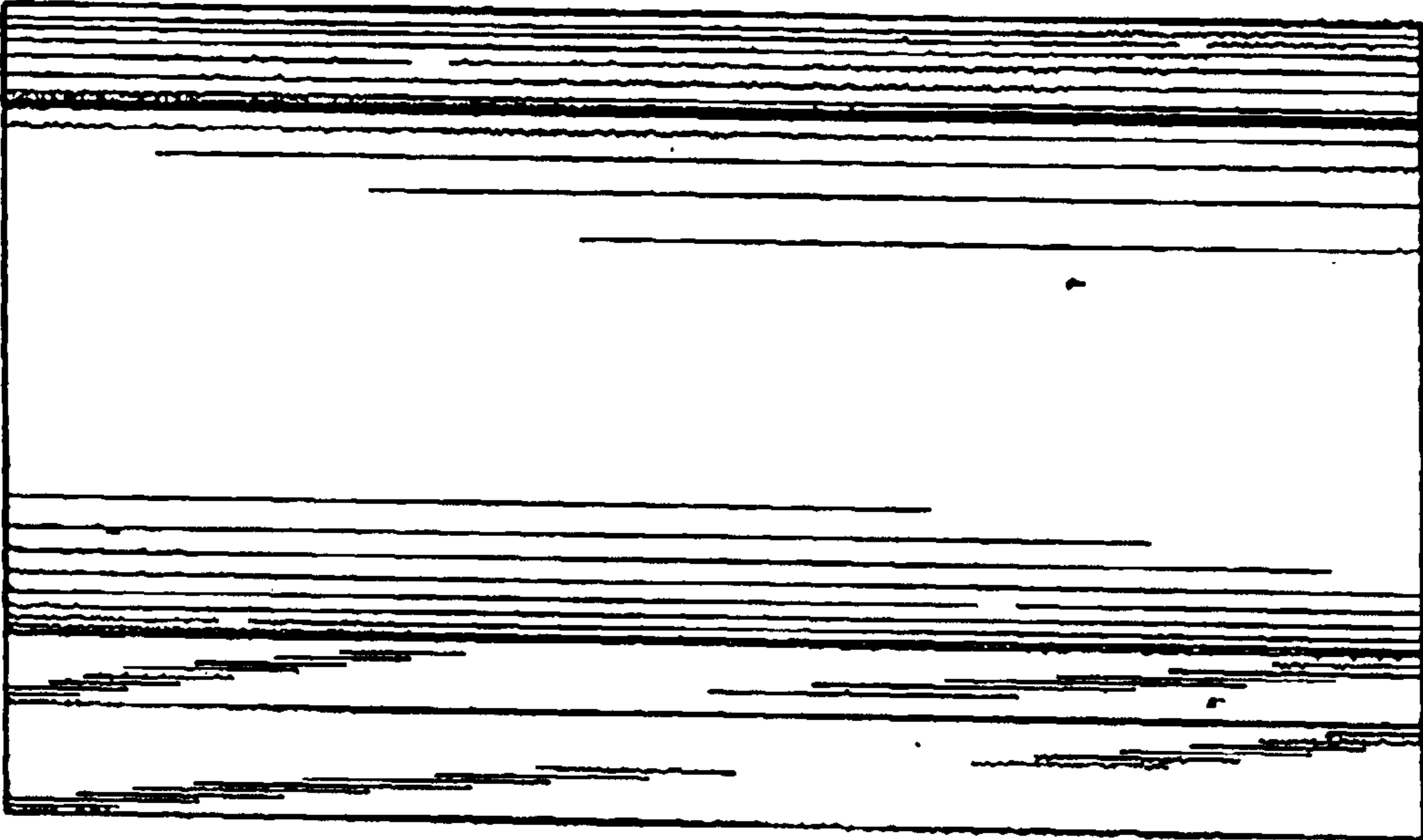

Fig. 4

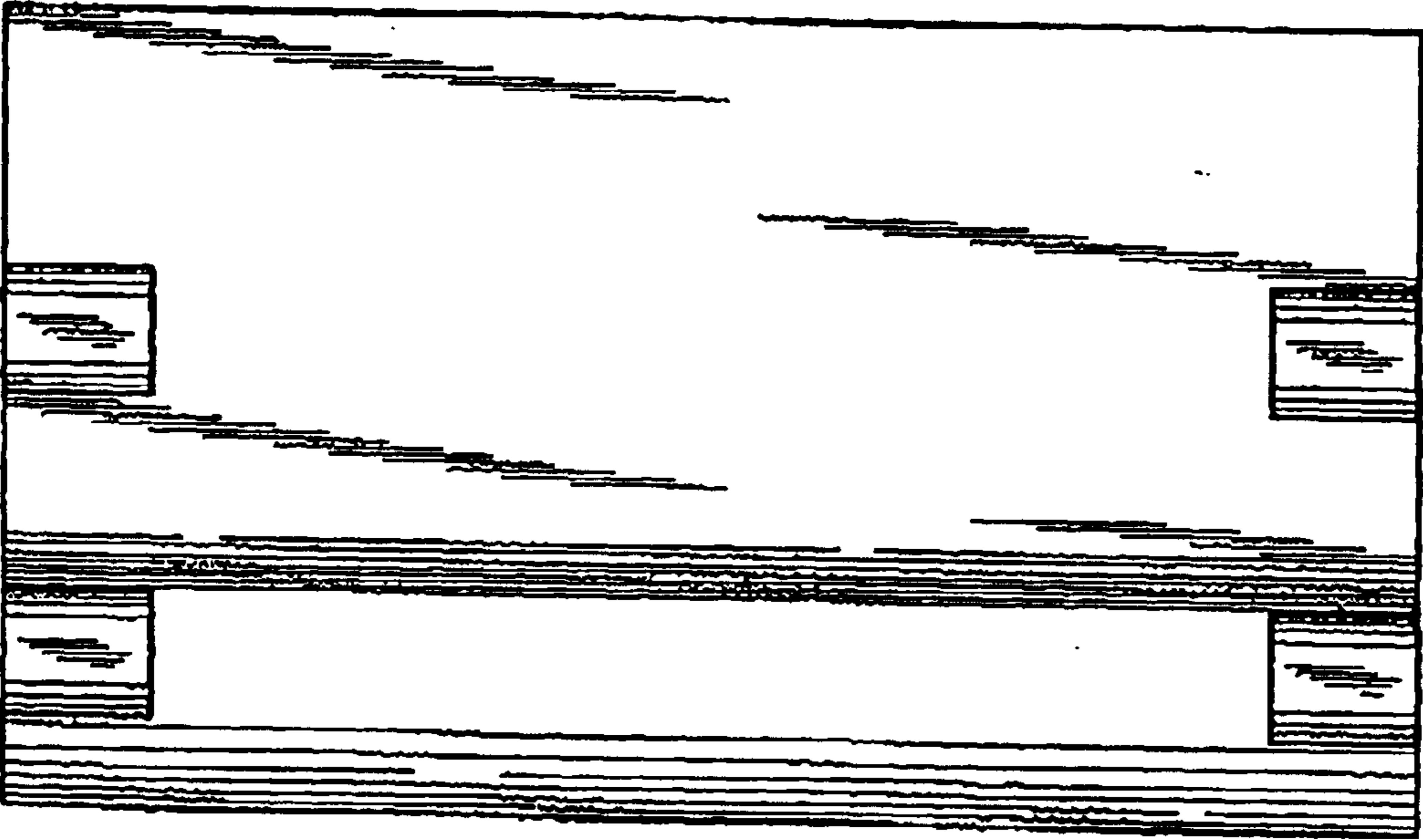

Fig. 5

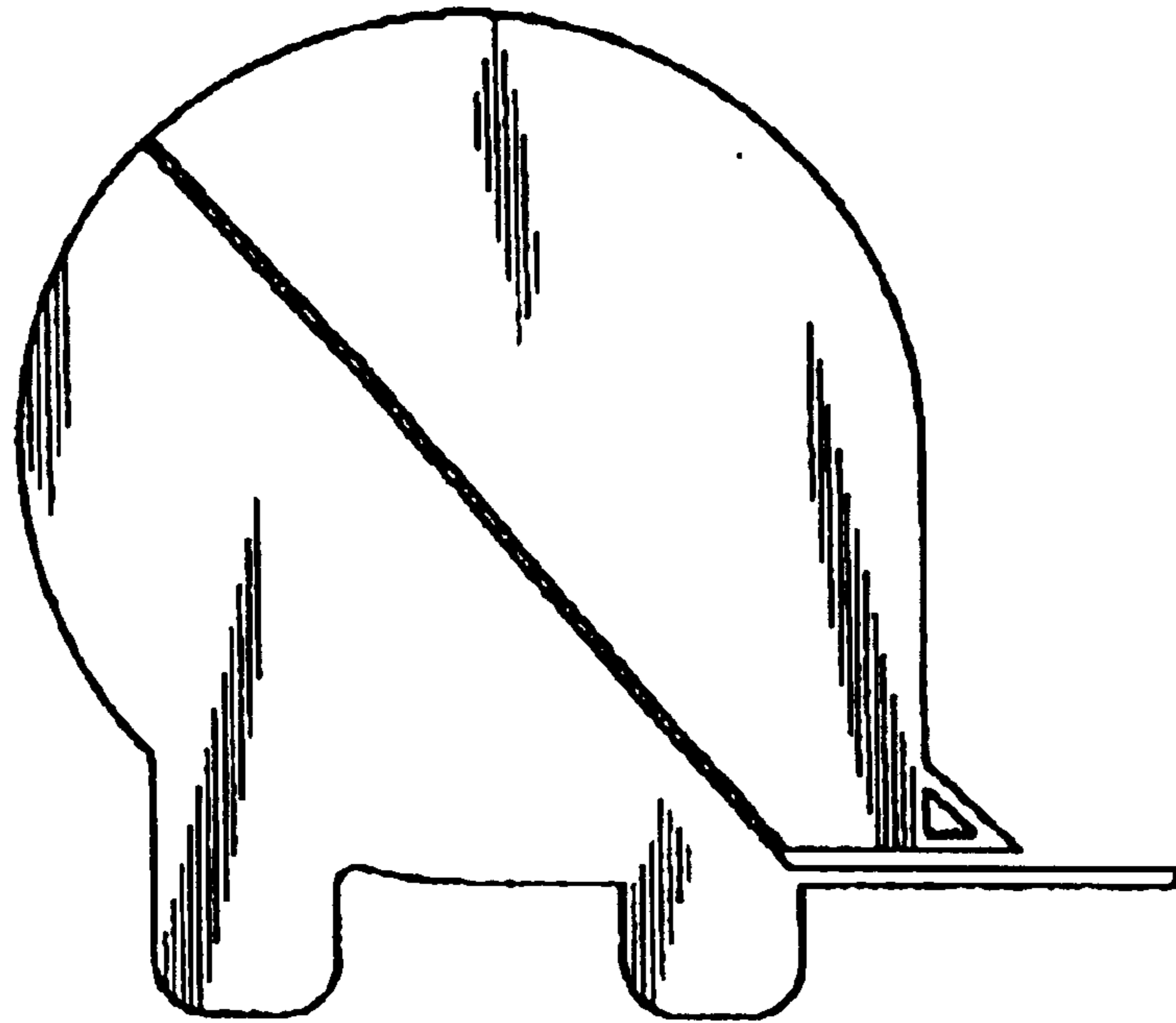

Fig. 6

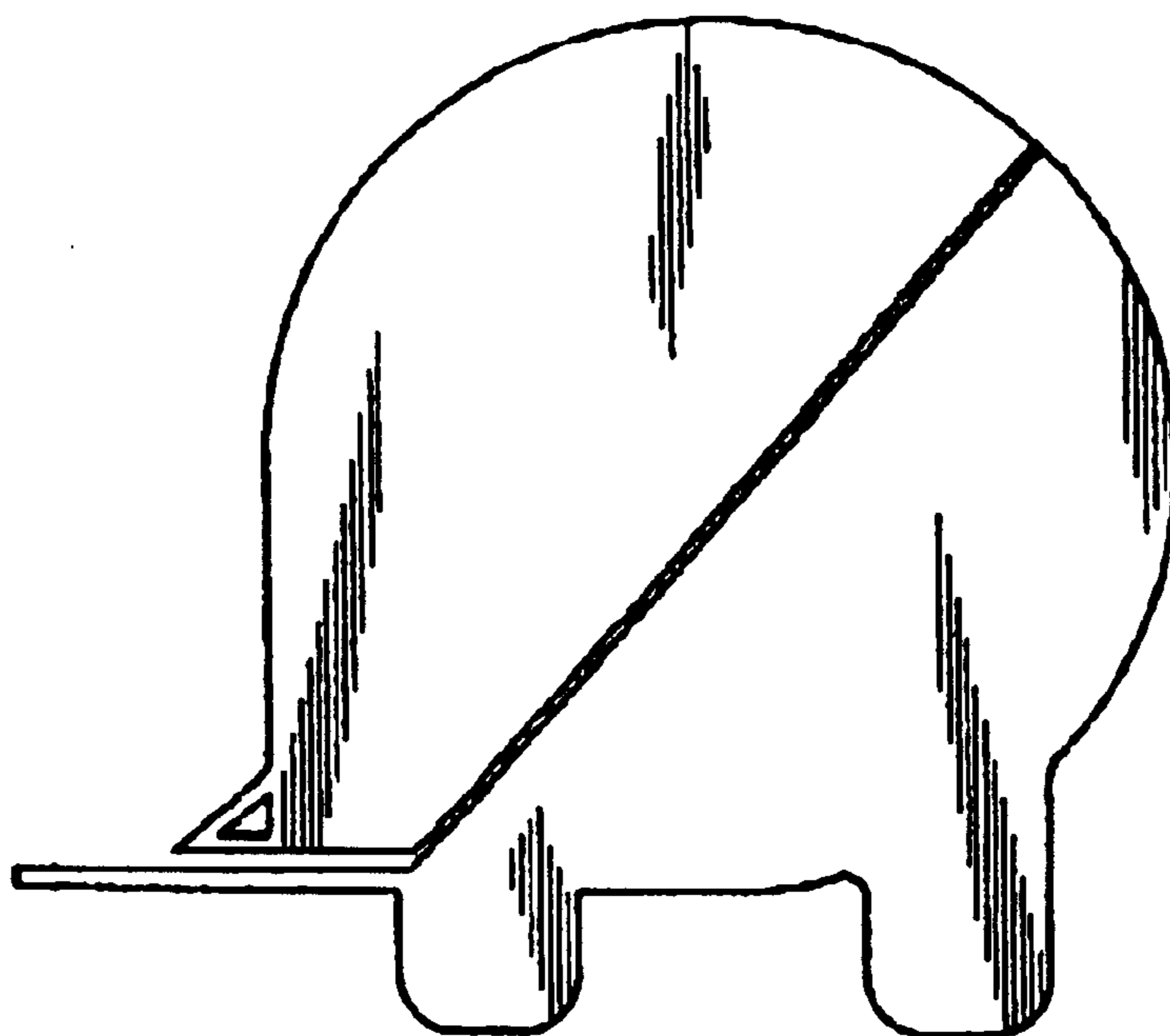

Fig. 7

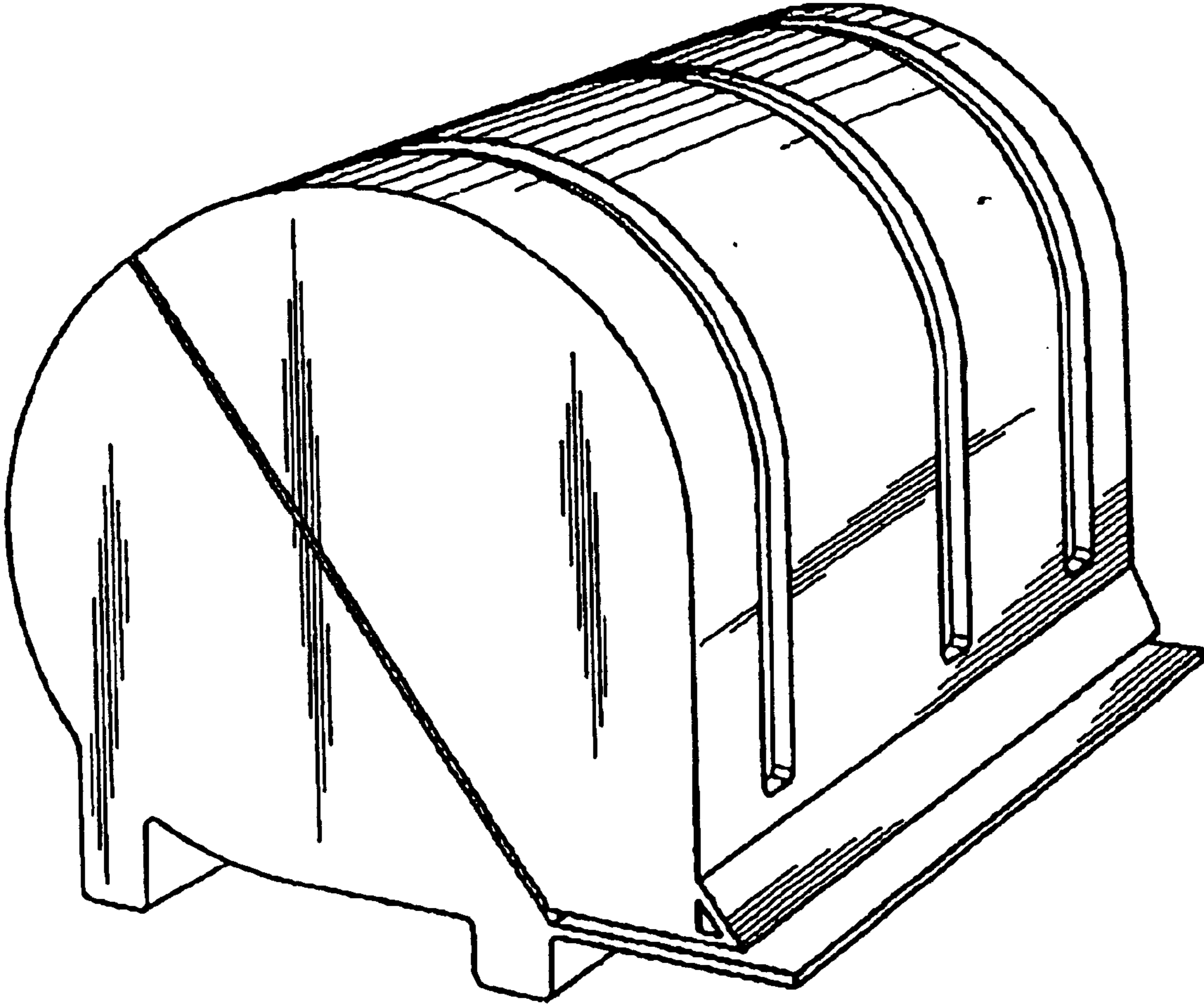

Fig. 8

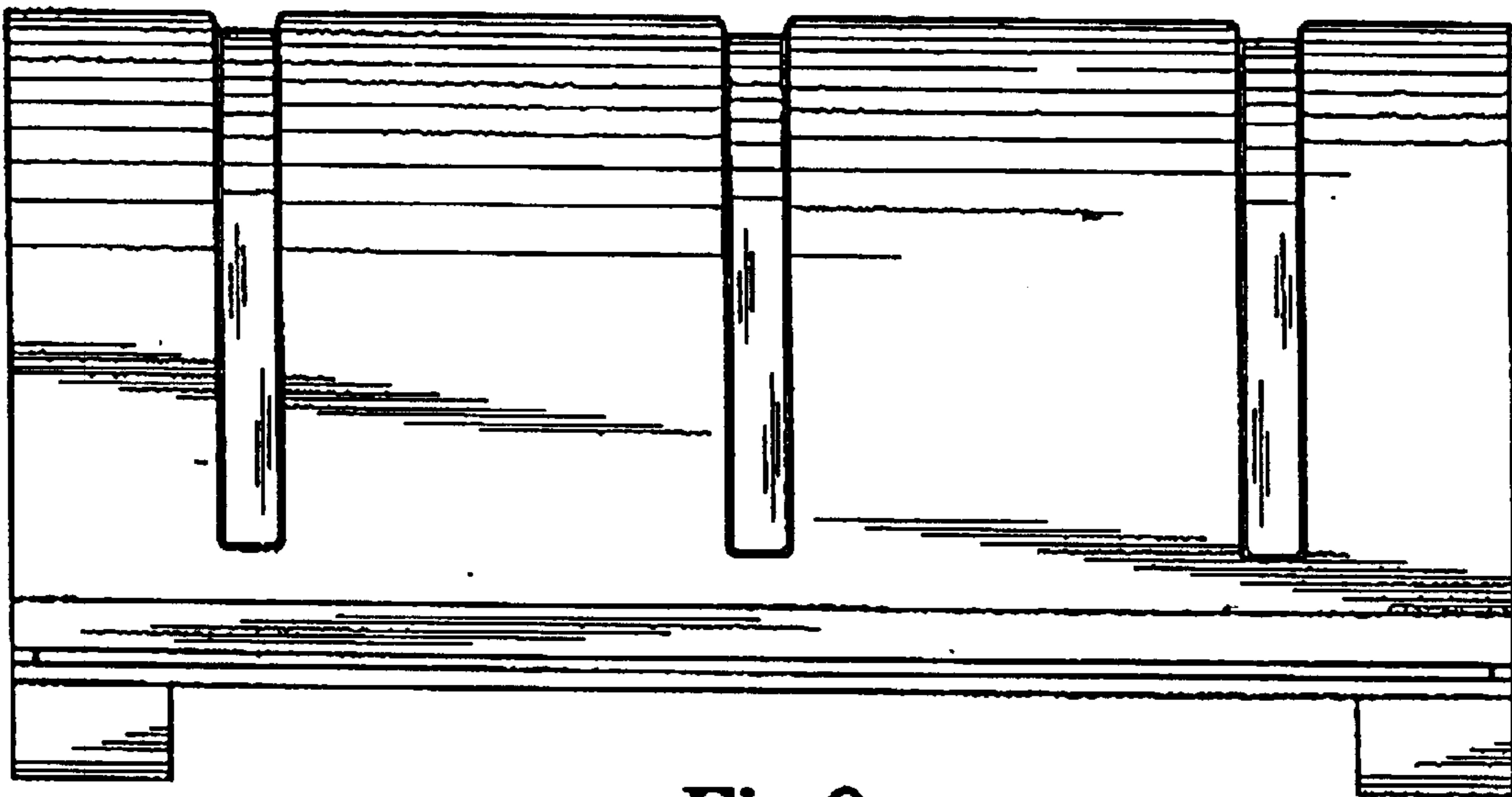

Fig. 9

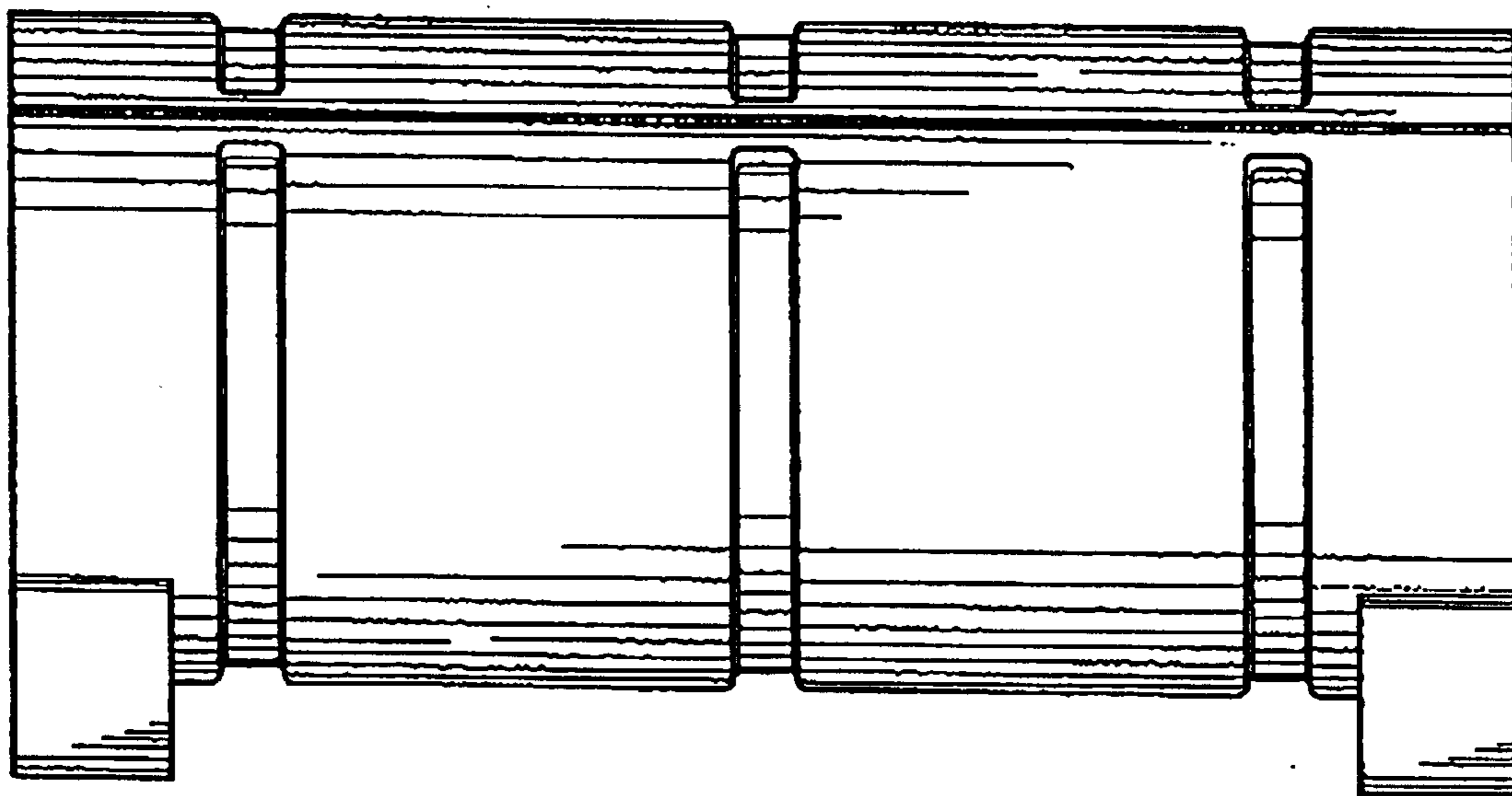

Fig. 10

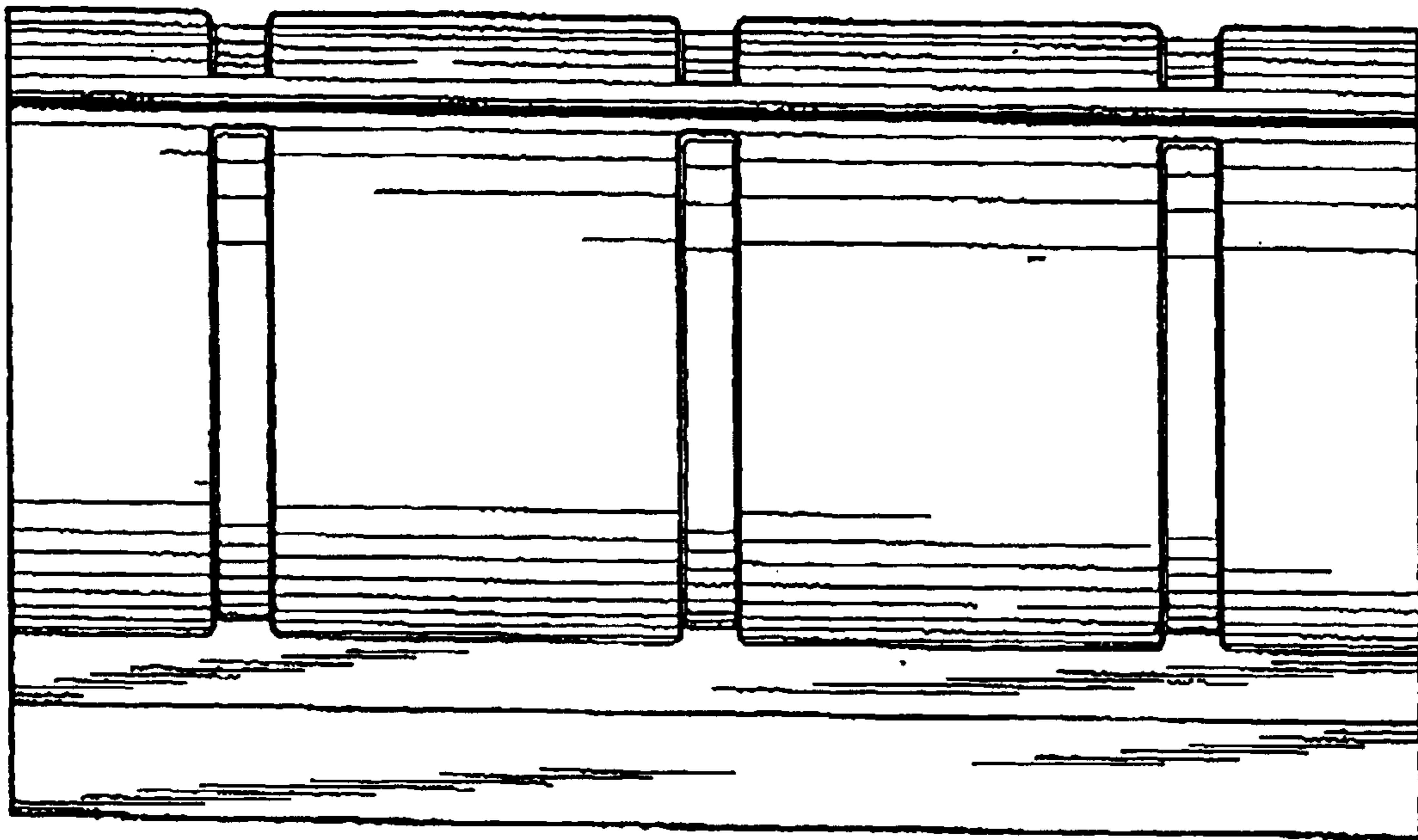

Fig. 11

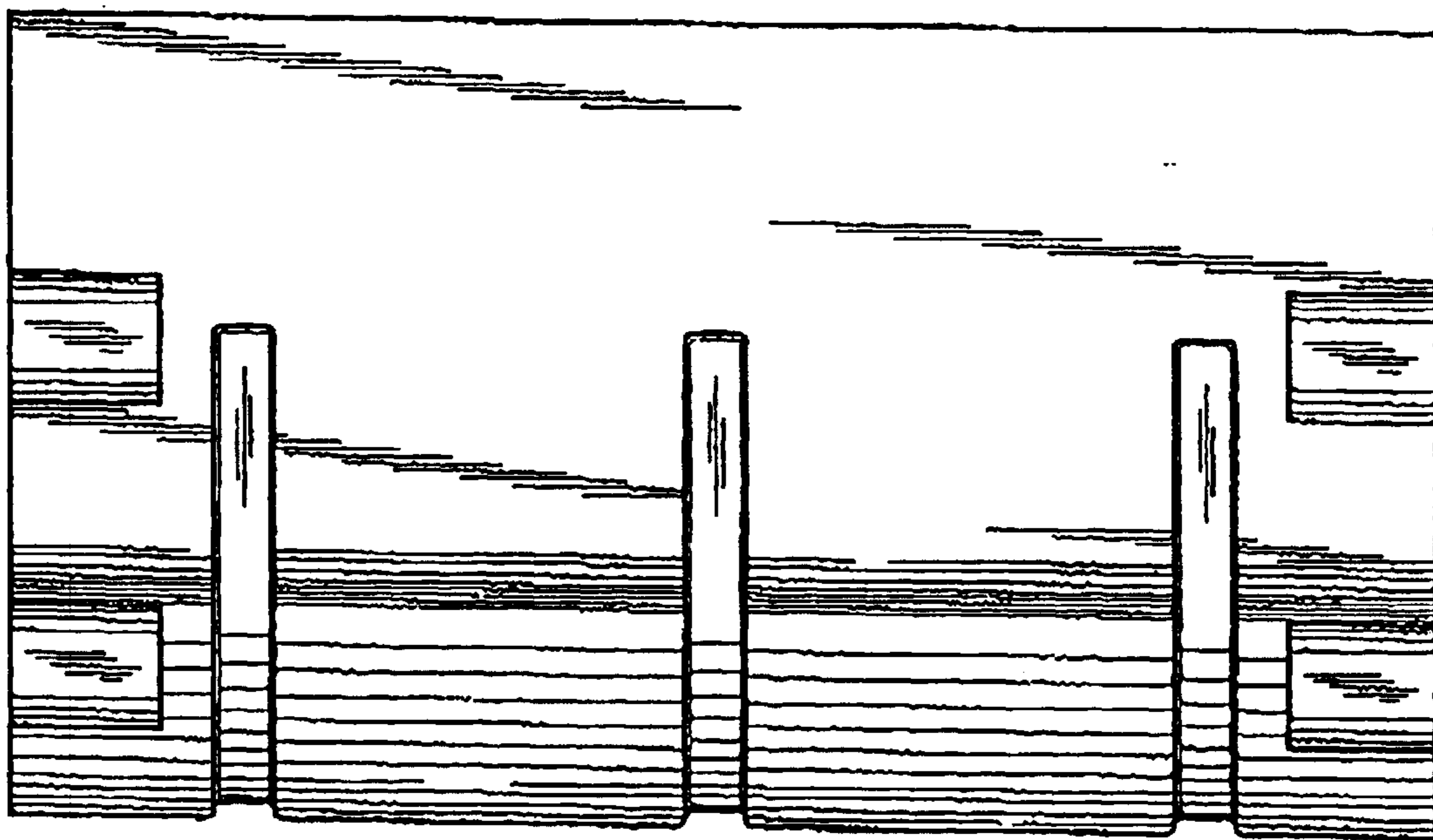

Fig. 12

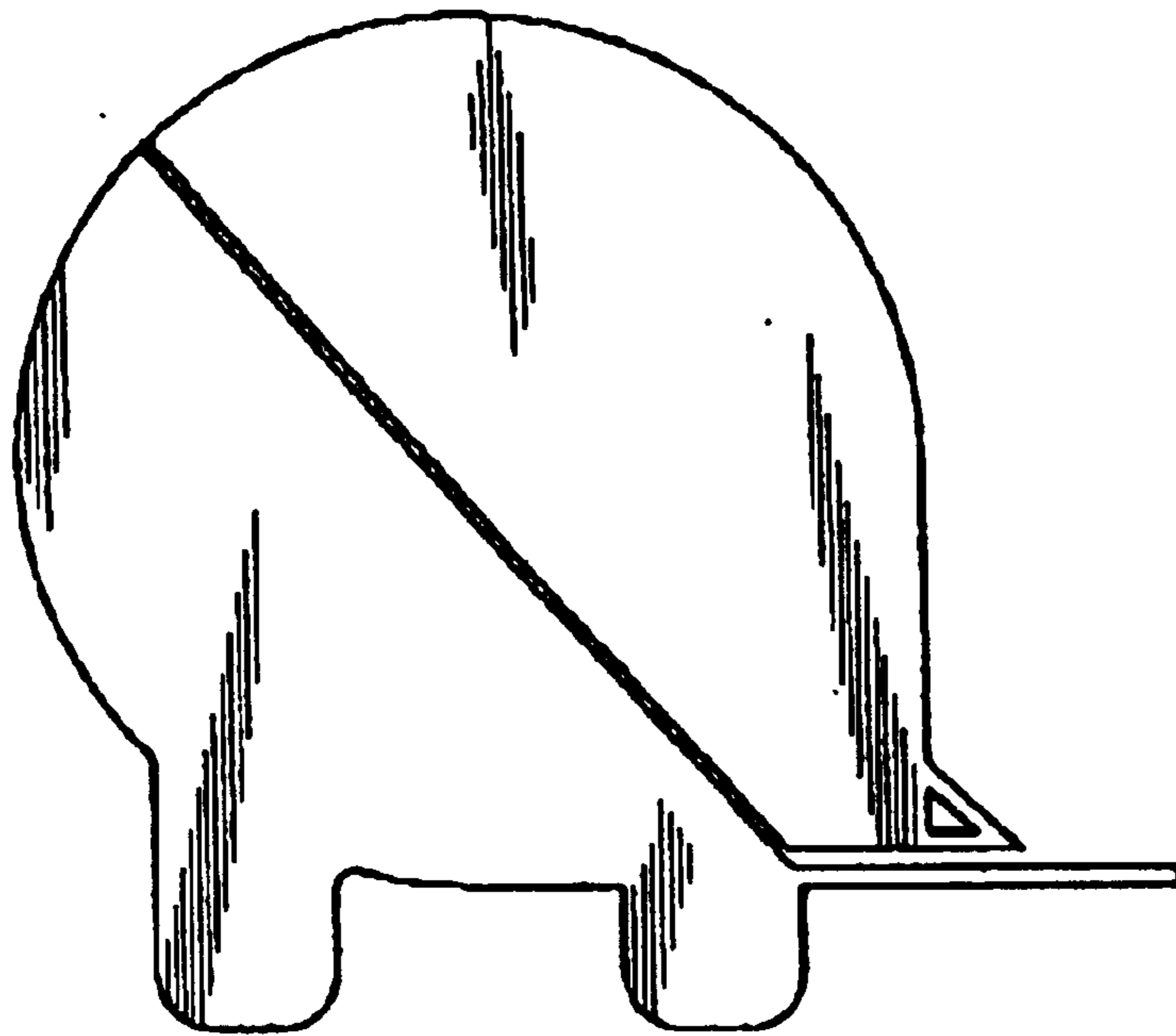

Fig.13

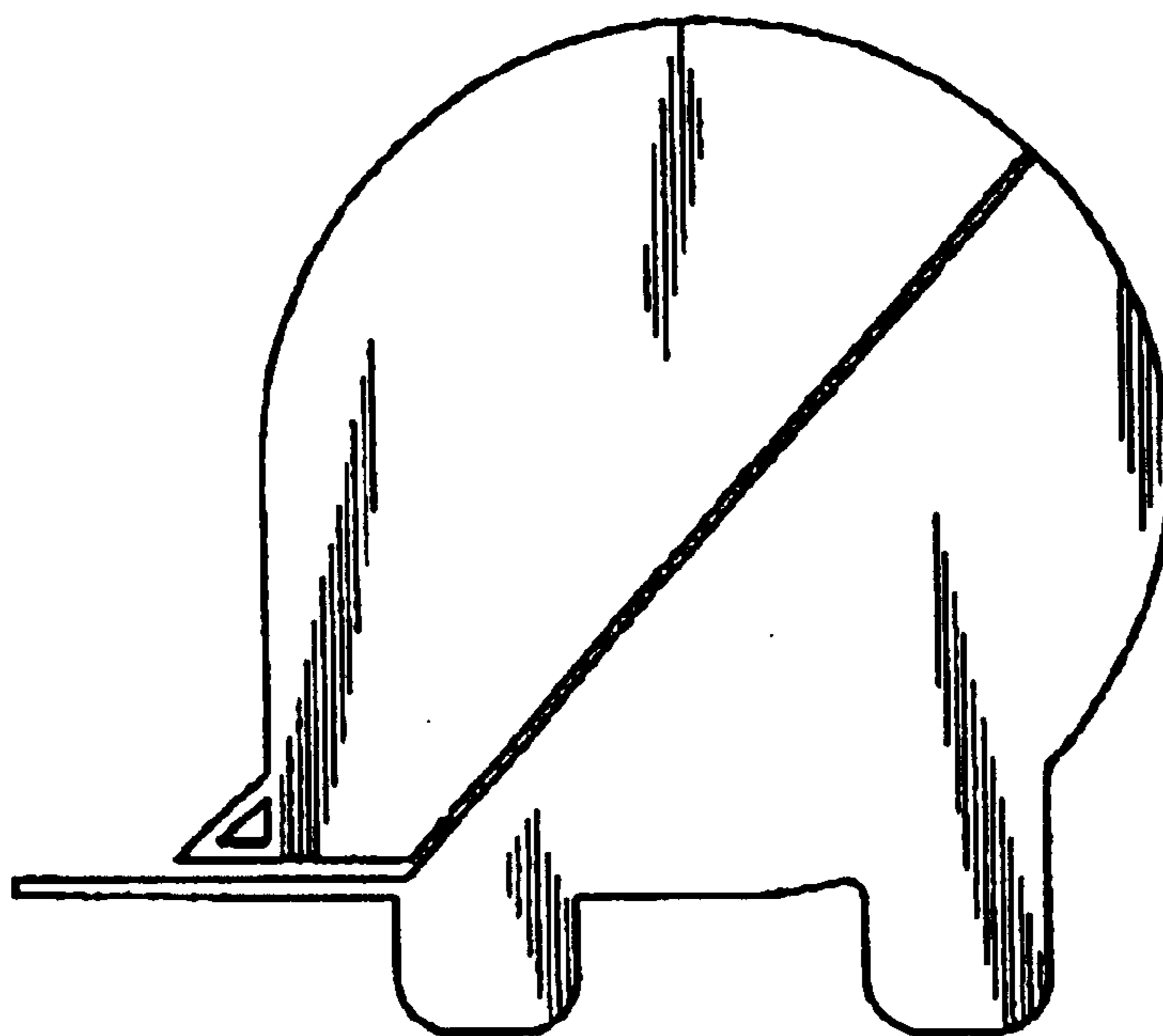

Fig.14

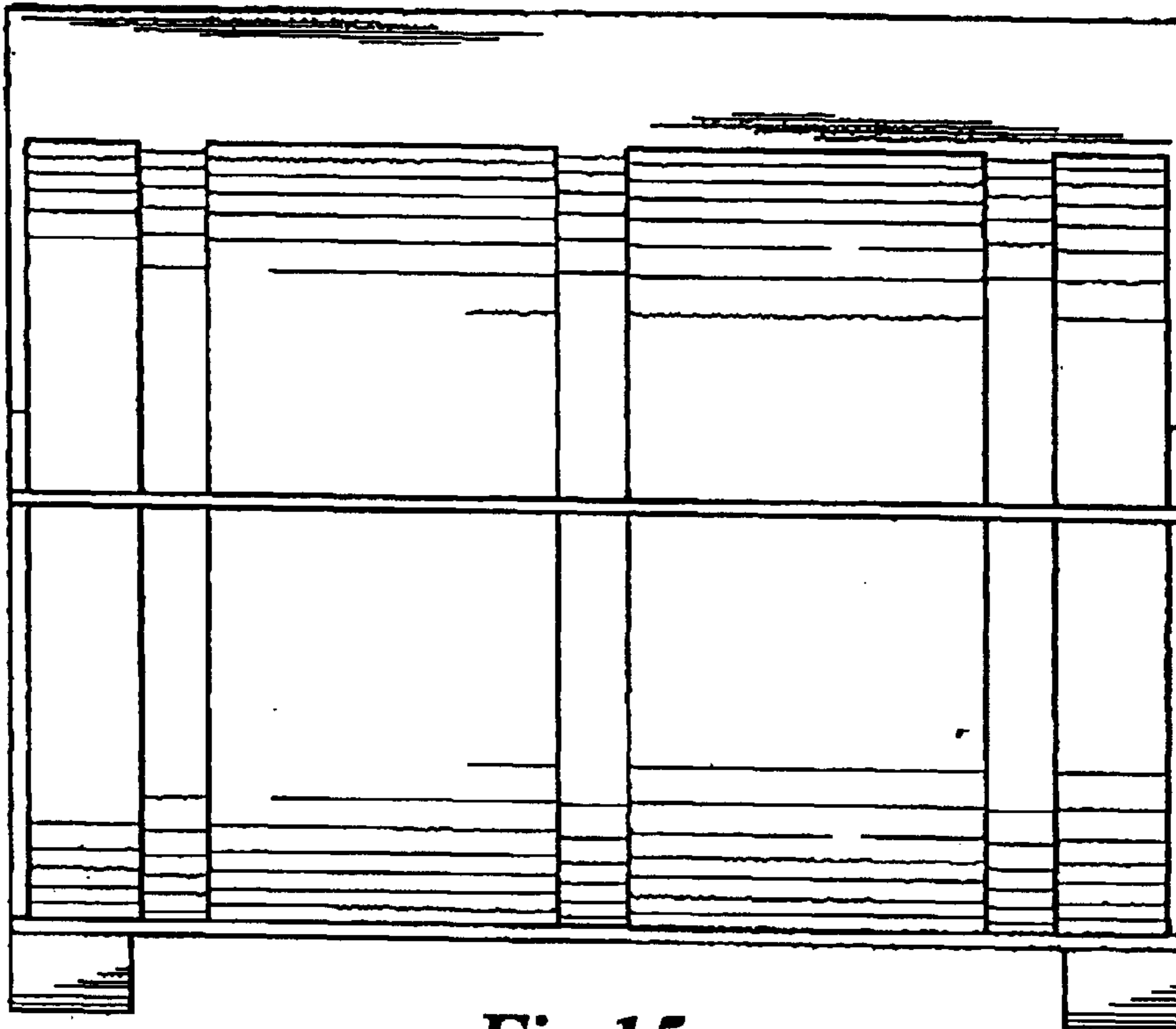

Fig.15

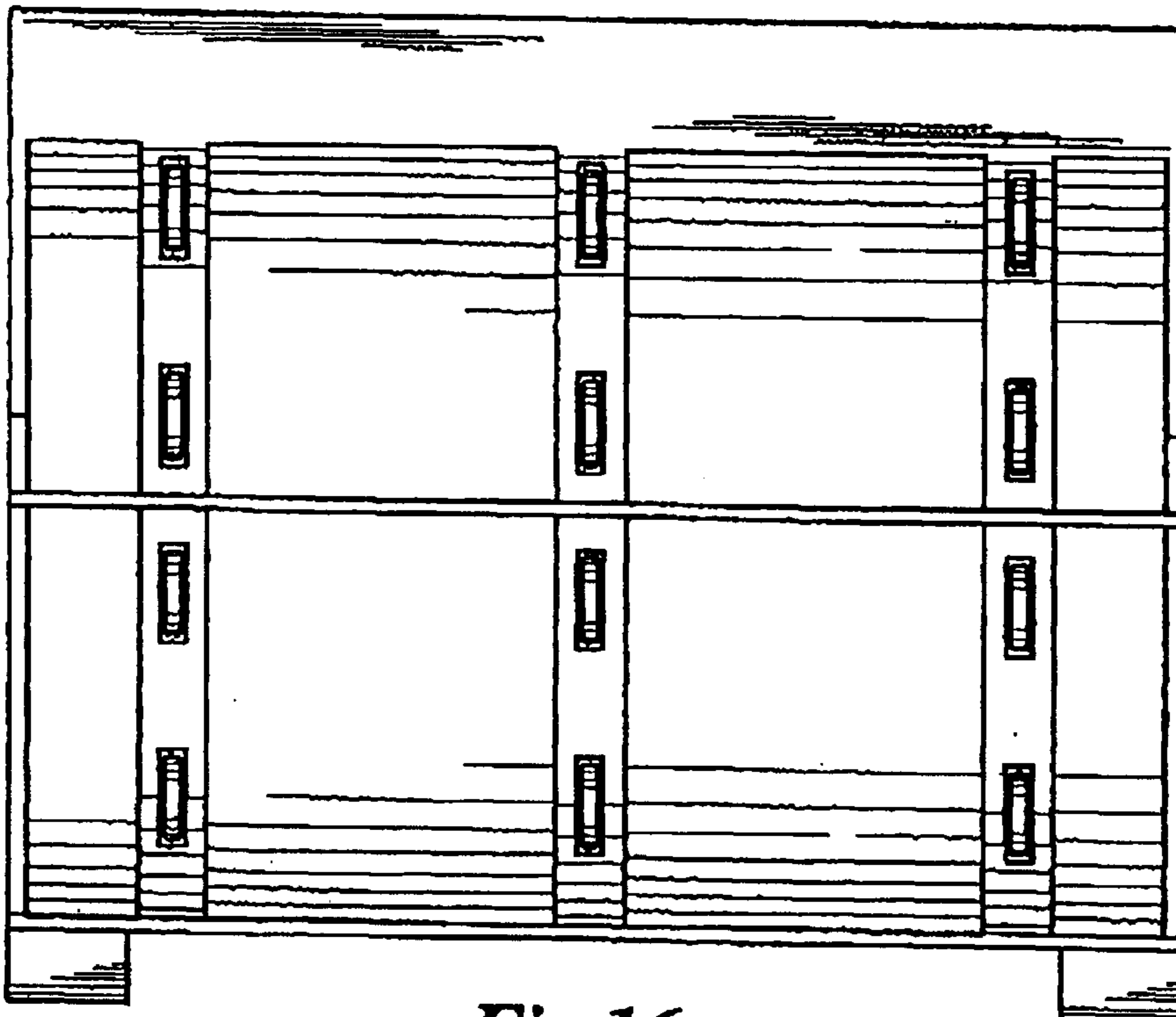

Fig.16

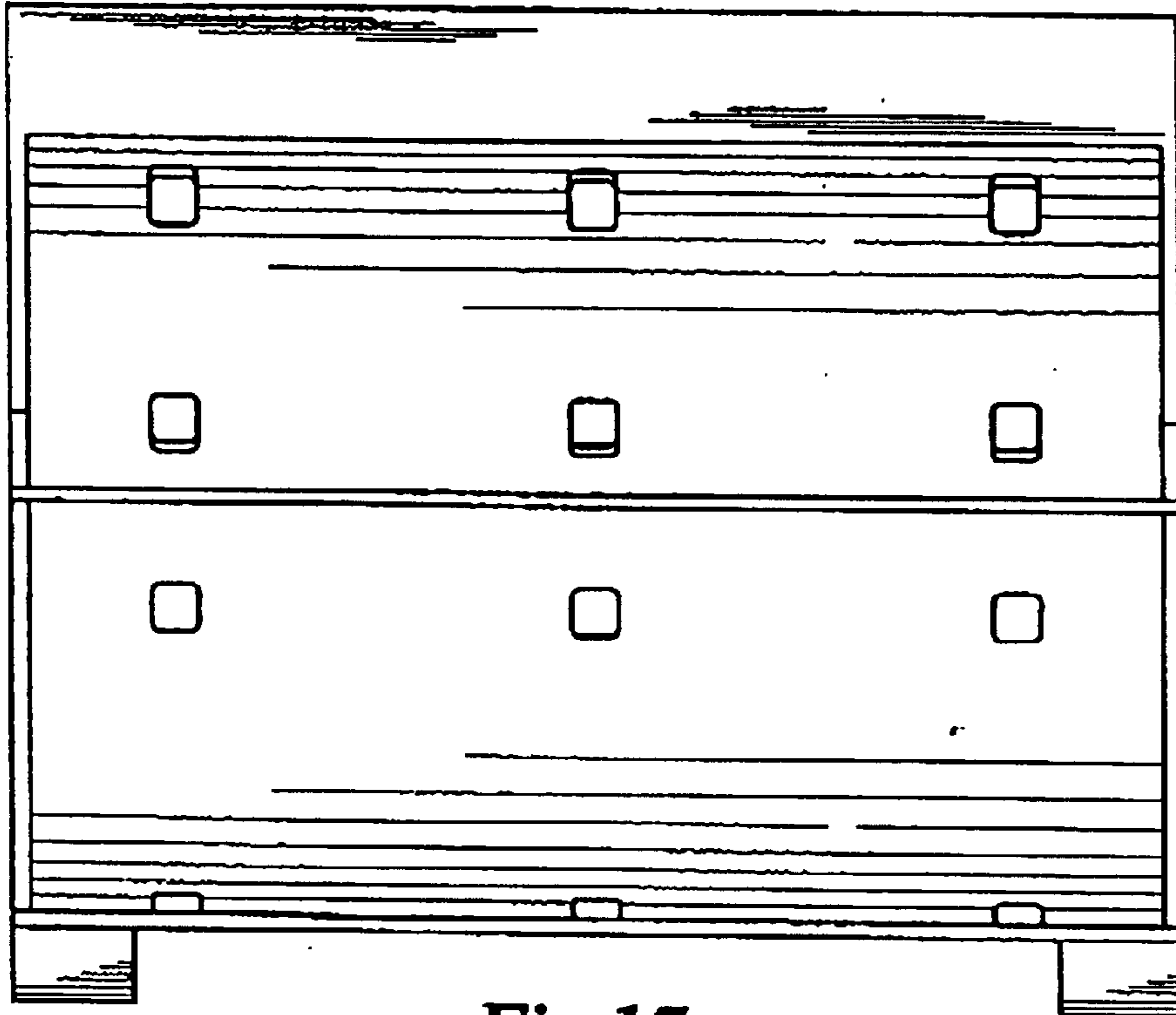

Fig.17

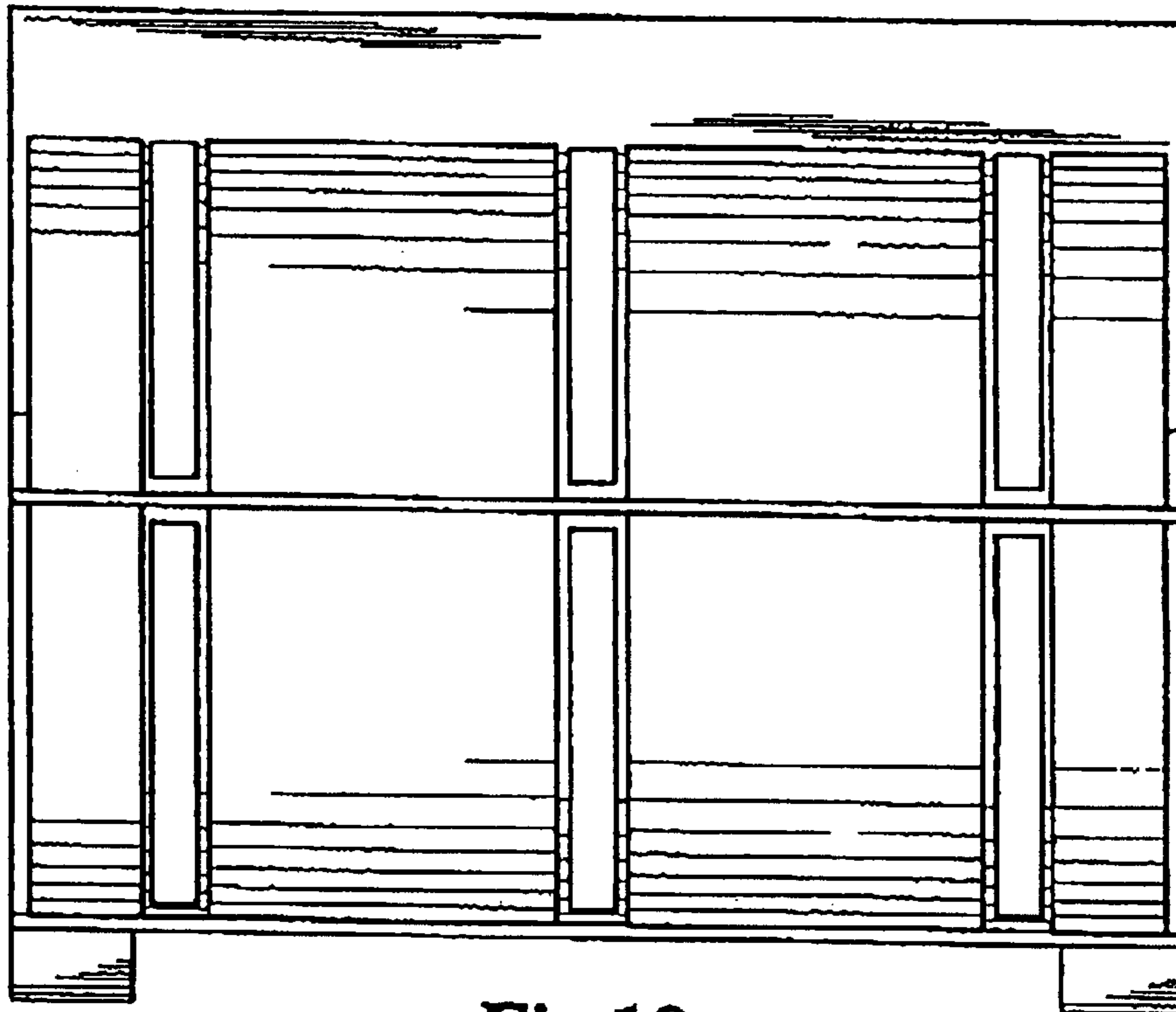

Fig.18