

US00D495179S1

(12) **United States Design Patent** (10) **Patent No.:** **US D495,179 S**
Bunnell et al. (45) **Date of Patent:** **** Aug. 31, 2004**

(54) **SHAVING SYSTEM CADDY**

(75) Inventors: **Jay Bunnell**, Orange, CT (US);
Christine Ciccone, New Haven, CT
(US); **Sean Lukan**, Milford, CT (US);
Paul Dansreau, Shelton, CT (US);
Mark Peyser, Easton, CT (US); **David**
Dombrowski, Madison, CT (US)

(73) Assignee: **Eveready Battery Company, Inc.**, St.
Louis, MO (US)

(**) Term: **14 Years**

(21) Appl. No.: **29/177,078**

(22) Filed: **Mar. 4, 2003**

(51) **LOC (7) Cl.** **28-03**

(52) **U.S. Cl.** **D6/526**

(58) **Field of Search** D6/526; 206/349,
206/351-360, 208-210; 211/13.1, 70.6,
86.01, 87.01, 88.01; 248/309.1

(56) **References Cited**

U.S. PATENT DOCUMENTS

3,945,499 A * 3/1976 Brownson 211/88.01
D335,599 S * 5/1993 Novak D6/526

5,228,580 A * 7/1993 Grange 211/70.6
D342,853 S * 1/1994 Grange D6/526
D364,060 S * 11/1995 Lai D6/526
D370,375 S * 6/1996 Murgida et al. D6/526
D423,845 S * 5/2000 Coffin et al. D6/526
D464,222 S * 10/2002 Coffin et al. D6/526

* cited by examiner

Primary Examiner—Brian N Vinson

(74) *Attorney, Agent, or Firm*—McCormick, Paulding & Huber LLP

(57) **CLAIM**

A new, original, and ornamental design for a shaving system caddy, as shown and described.

DESCRIPTION

FIG. 1 is a perspective view showing our new design;
FIG. 2 is a front view thereof;
FIG. 3 is a right side view thereof;
FIG. 4 is a left side view thereof;
FIG. 5 is a top view thereof; and,
FIG. 6 is a bottom view thereof.

The portions shown in broken lines on the drawings represent environment only, and form no part of the claimed design.

1 Claim, 2 Drawing Sheets

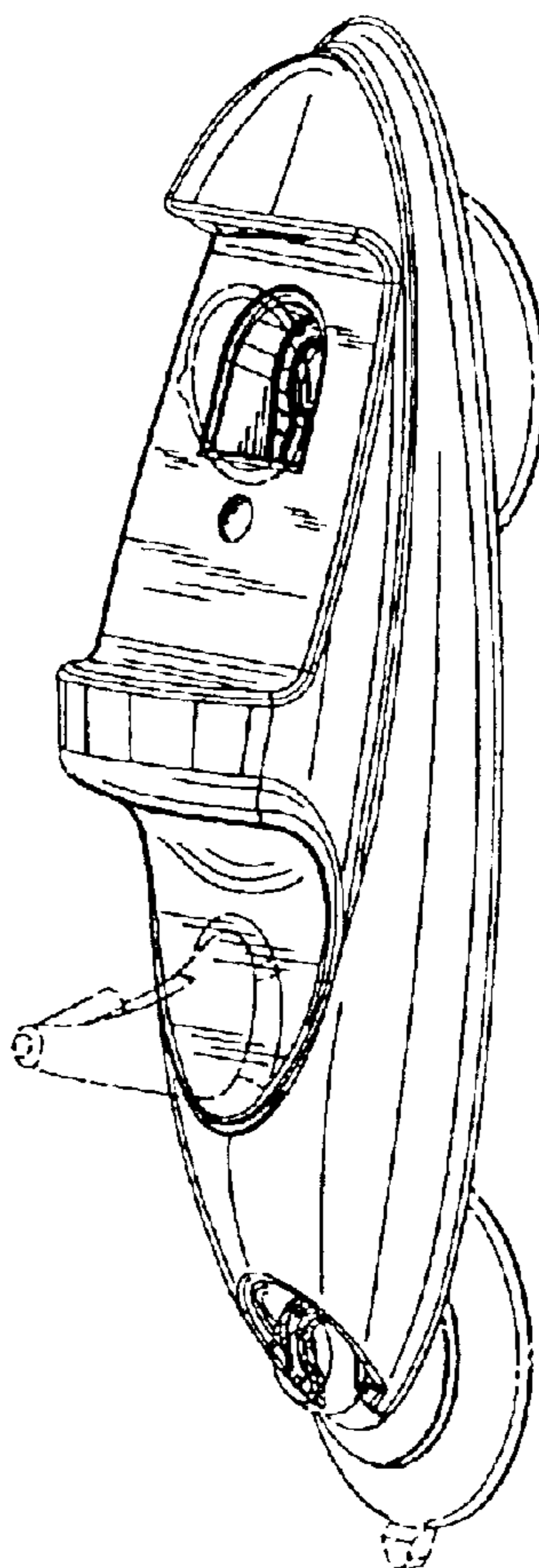

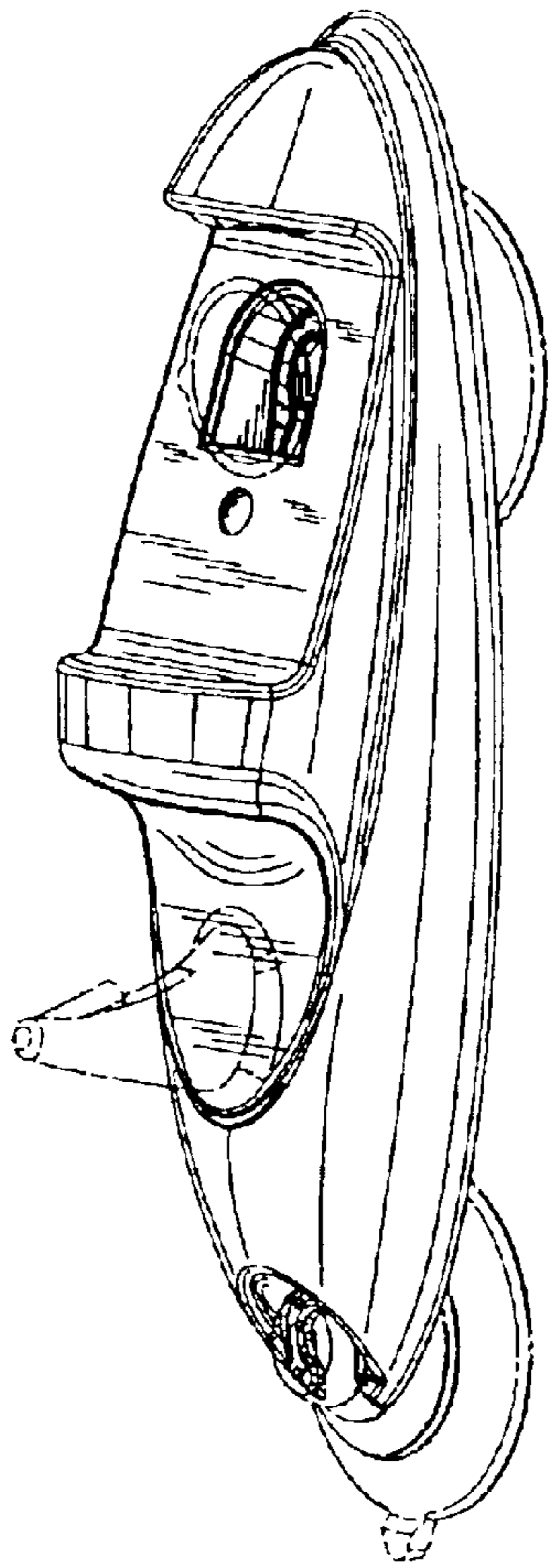

FIG. 1

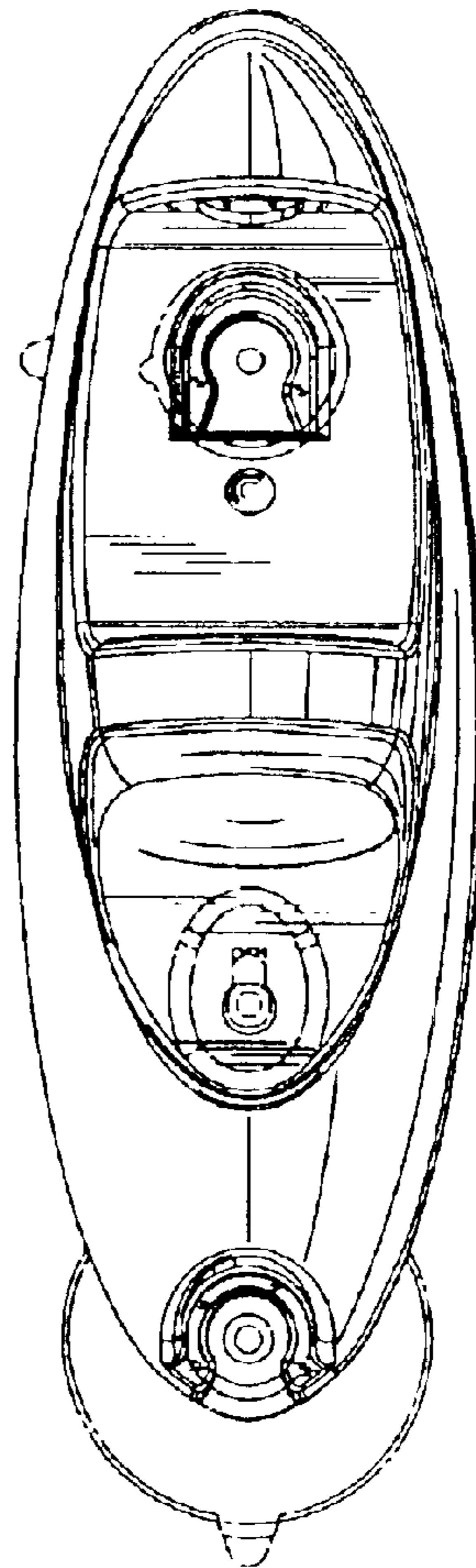

FIG. 2

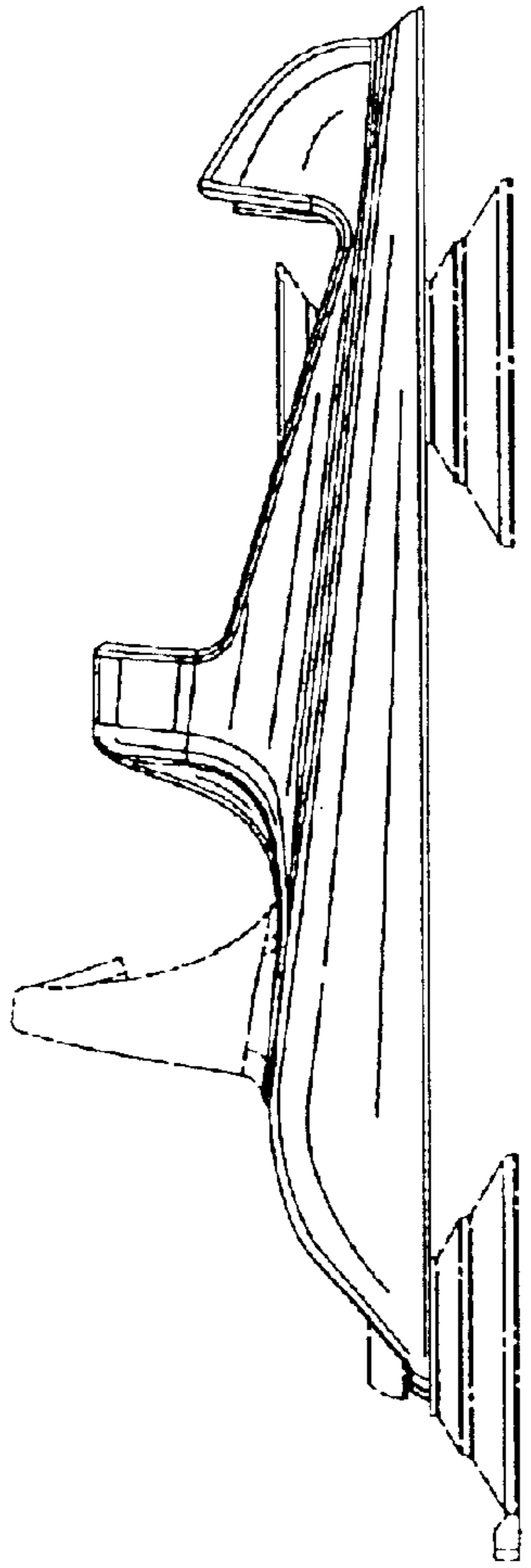

FIG. 3

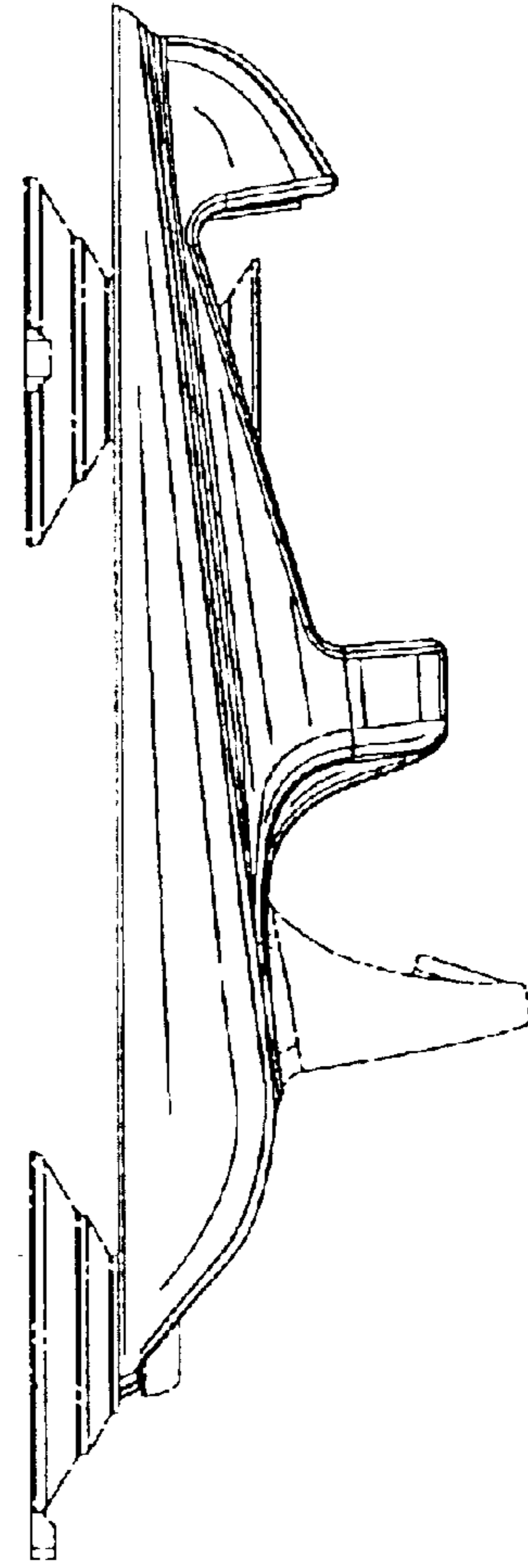

FIG. 4

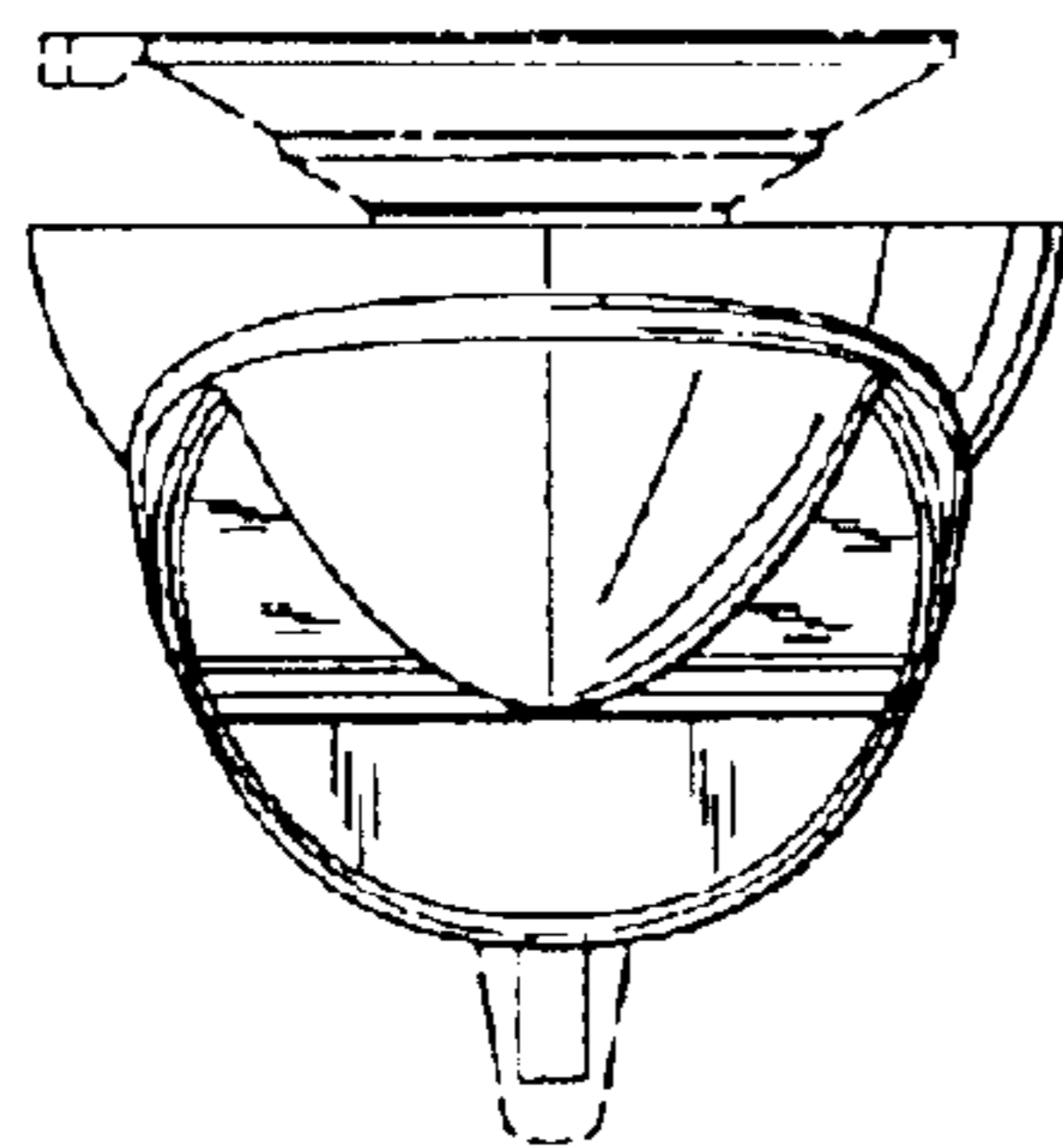

FIG. 5

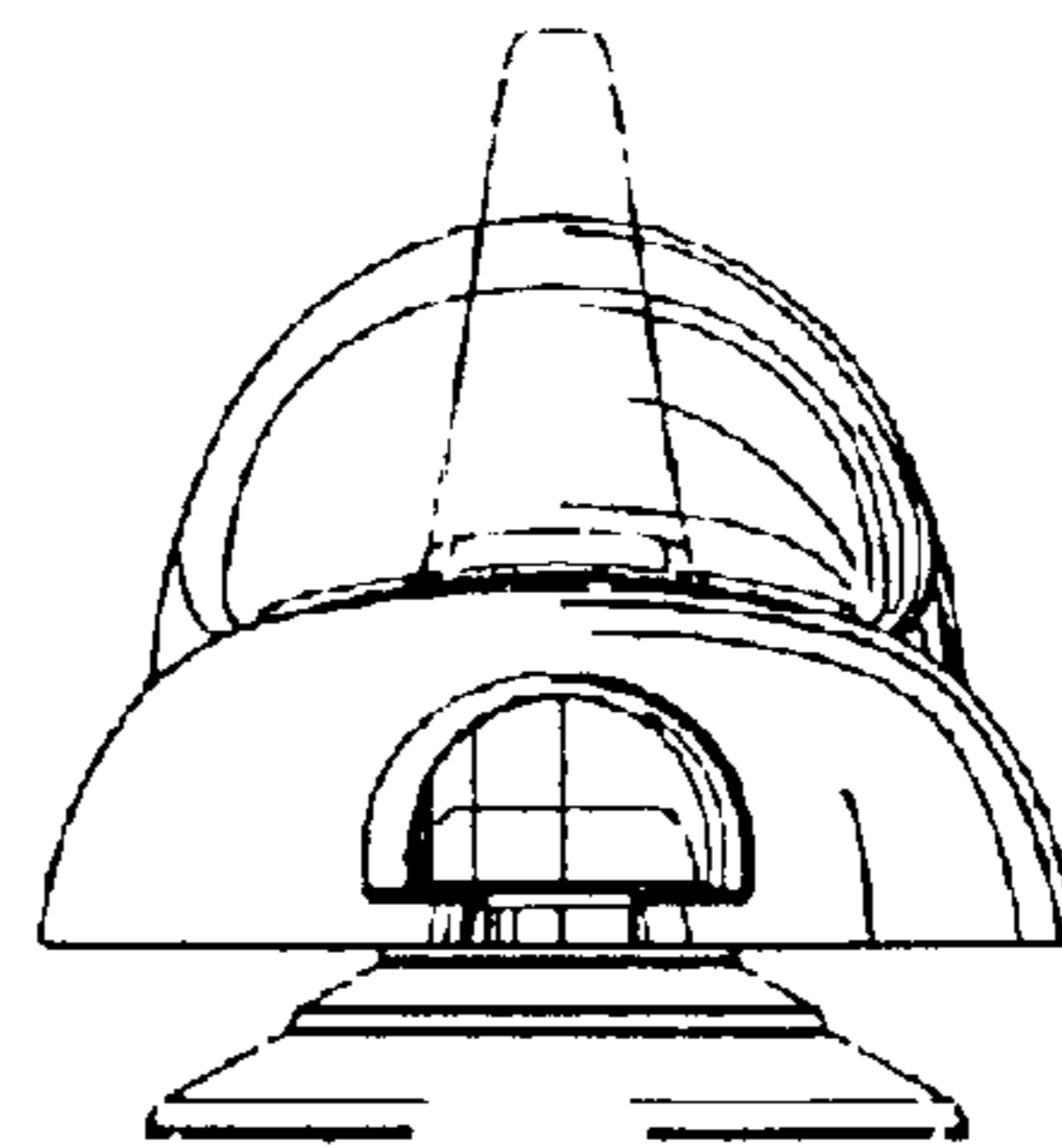

FIG. 6