



US00D495159S1

(12) **United States Design Patent** (10) **Patent No.:** **US D495,159 S**
Ricci (45) **Date of Patent:** **** Aug. 31, 2004**

(54) **SEAT**
(75) **Inventor:** **Luca Ricci, Forli (IT)**
(73) **Assignee:** **De Coro Ltd., Fanling (HK)**
(**) **Term:** **14 Years**

(21) **Appl. No.:** **29/196,875**
(22) **Filed:** **Jan. 7, 2004**

(51) **LOC (7) Cl. 06-01**
(52) **U.S. Cl. D6/381; D6/334**
(58) **Field of Search D6/334, 335, 336,**
D6/364, 371, 381, 500, 501, 502; 5/12.1;
297/232

(56) **References Cited**

U.S. PATENT DOCUMENTS

D385,121 S	*	10/1997	Natuzzi et al.	D6/381
D388,260 S		12/1997	Natuzzi et al.	
D393,759 S	*	4/1998	Natuzzi et al.	D6/381
D399,361 S		10/1998	Natuzzi et al.	
D399,362 S		10/1998	Natuzzi et al.	
D399,363 S		10/1998	Natuzzi et al.	
D399,364 S		10/1998	Natuzzi et al.	
D423,236 S		4/2000	Palumbo	
D430,411 S		9/2000	Zaidman	
D440,067 S	*	4/2001	Corella	D6/381
D468,927 S		1/2003	Denton	
D469,264 S	*	1/2003	Natuzzi et al.	D6/334
D470,327 S		2/2003	Ricci	
D470,676 S		2/2003	Ricci	
D474,910 S		5/2003	Ricci	
D474,912 S		5/2003	Ricci	
D476,501 S		7/2003	Ricci	
D482,893 S	*	12/2003	Ricci	D6/381

OTHER PUBLICATIONS

De Coro Ltd. Sofa Model No. 104, Apr. 1998, at the International Home Furnishings Market in High Point N.C.
De Coro Ltd. Sofa Model No. 108, Apr. 1998, at the International Home Furnishings Market in High Point N.C.
De Coro Ltd. Sofa Model No. 128, Apr. 1998, at the International Home Furnishings Market in High Point N.C.

De Coro Ltd. Sofa Model No. 166, Apr. 1998, at the International Home Furnishings Market in High Point N.C.
De Coro Ltd. Sofa Model No. 285, Apr. 1999, at the International Home Furnishings Market in High Point N.C.
De Coro Ltd. Sofa Model No. 2052, Apr. 2000, at the International Home Furnishings Market in High Point N.C.
De Coro Ltd. Sofa Model No. 2138, Oct. 2001, at the International Home Furnishings Market in High Point N.C.
De Coro Ltd. Sofa Model No. 2162, Oct. 2001, at the International Home Furnishings Market in High Point N.C.

(List continued on next page.)

Primary Examiner—Gary D. Watson
(74) *Attorney, Agent, or Firm*—Luce, Forward, Hamilton & Scripps, LLP

(57) **CLAIM**

The ornamental design for a seat, as shown and described.

DESCRIPTION

FIG. 1 is a front perspective view of one embodiment of my new seat design in the form of a sofa;
FIG. 2 is an enlarged front perspective view of a portion of the embodiment of FIG. 1;
FIG. 3 is a front elevation view of the embodiment of FIG. 1;
FIG. 4 is a left, side elevation view of the embodiment of FIG. 1, with the right side elevational view being a mirror image thereof;
FIG. 5 is a rear elevation view of the embodiment of FIG. 1;
FIG. 6 is a front perspective view of a second embodiment of my new seat design in the form of a chair;
FIG. 7 is a front elevation view of the embodiment of FIG. 6; and,
FIG. 8 is a rear elevation view of the embodiment of FIG. 6.

The side elevation views of FIGS. 6, 7, and 8 are like that shown in FIG. 4.

The broken line disclosure is for illustrative purposes only and forms no part of the claimed design.

1 Claim, 4 Drawing Sheets

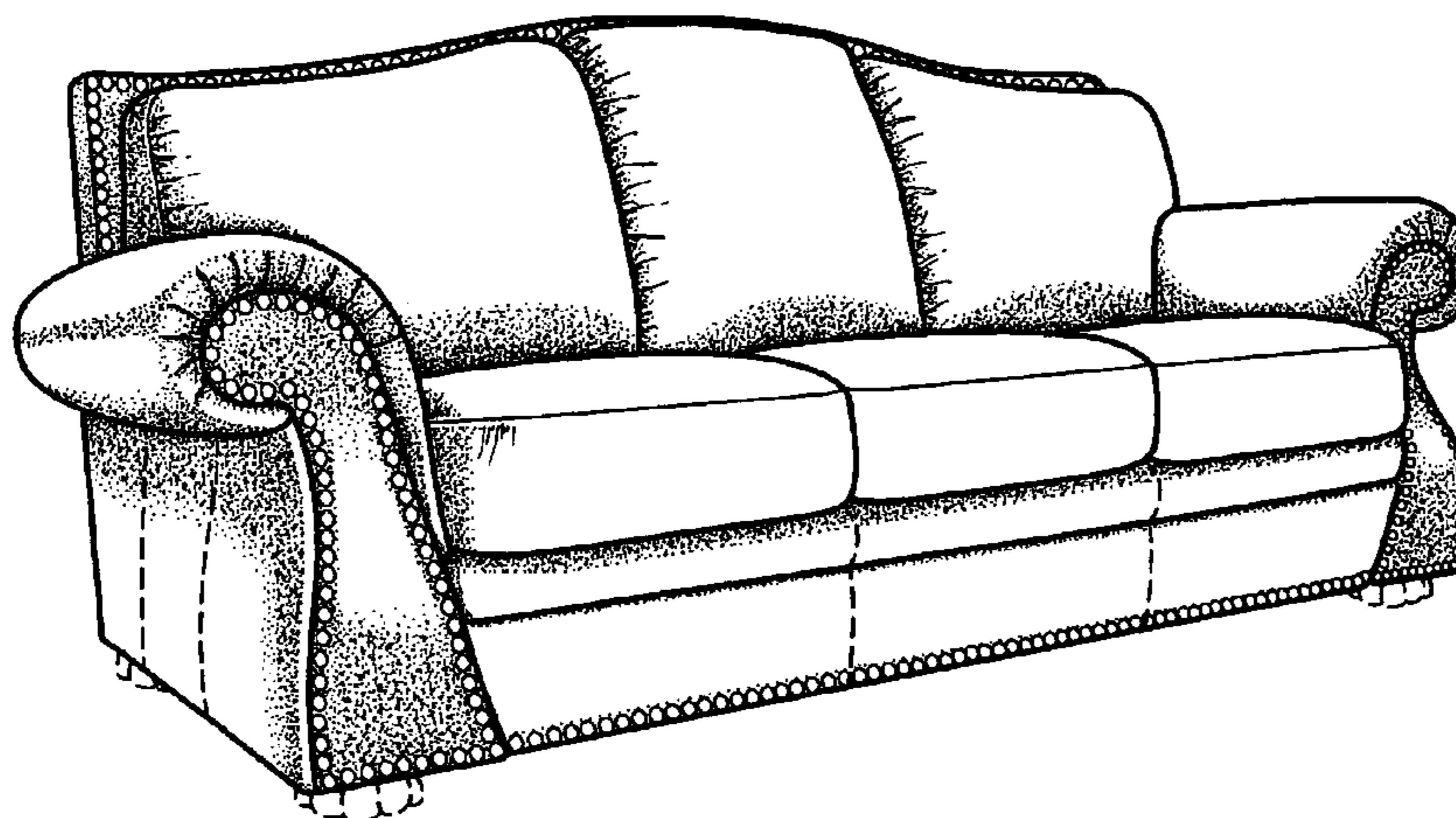

OTHER PUBLICATIONS

De Coro Ltd. Sofa Model No. 2163, Oct. 2001, at the International Home Furnishings Market in High Point N.C.
De Coro Ltd. Sofa Model No. 2167, Oct. 2001, at the International Home Furnishings Market in High Point N.C.
De Coro Ltd. Sofa Model No. 2172, Apr. 2002, at the International Home Furnishings Market in High Point N.C.
De Coro Ltd. Sofa Model No. 2196, Apr. 2002, at the International Home Furnishings Market in High Point N.C.
De Coro Ltd. Sofa Model No. 2203, Apr. 2002, at the International Home Furnishings Market in High Point N.C.
De Coro Ltd. Sofa Model No. 2207, Apr. 2002, at the International Home Furnishings Market in High Point N.C.
De Coro Ltd. Sofa Model No. 2208, Apr. 2002, at the International Home Furnishings Market in High Point N.C.
De Coro Ltd. Sofa Model No. 2213, Apr. 2002, at the International Home Furnishings Market in High Point N.C.
De Coro Ltd. Sofa Model No. 2214, Apr. 2002, at the International Home Furnishings Market in High Point N.C.
De Coro Ltd. Sofa Model No. 2222, Apr. 2002, at the International Home Furnishings Market in High Point N.C.
De Coro Ltd. Sofa Model No. 2229, Apr. 2002, at the International Home Furnishings Market in High Point N.C.
De Coro Ltd. Sofa Model No. 2241, Oct. 2002, at the International Home Furnishings Market in High Point N.C.

De Coro Ltd. Sofa Model No. 2242, Oct. 2002, at the International Home Furnishings Market in High Point N.C.
De Coro Ltd. Sofa Model No. 2260, Oct. 2002, at the International Home Furnishings Market in High Point N.C.
De Coro Ltd. Sofa Model No. 2264, Oct. 2002, at the International Home Furnishings Market in High Point N.C.
De Coro Ltd. Sofa Model No. 2279, Oct. 2002, at the International Home Furnishings Market in High Point N.C.
De Coro Ltd. Sofa Model No. 2281, Oct. 2002, at the International Home Furnishings Market in High Point N.C.
De Coro Ltd. Sofa Model No. 2287, Oct. 2002, at the International Home Furnishings Market in High Point N.C.
De Coro Ltd. Sofa Model No. 2288, Oct. 2002, at the International Home Furnishings Market in High Point N.C.
De Coro Ltd. Chair Model No. 2289, Oct. 2002, at the International Home Furnishings Market in High Point N.C.
De Coro Ltd. Sofa Model No. 2309, Oct. 2002, at the International Home Furnishings Market in High Point N.C.
De Coro Ltd. Sofa Model No. 2282, Oct. 2002, at the International Home Furnishings Market in High Point N.C.
De Coro Ltd. Sofa Model No. 2285, Oct. 2002, at the International Home Furnishings Market in High Point N.C.
De Coro Ltd. Sofa Model No. 2303, Oct. 2002, at the International Home Furnishings Market in High Point N.C.

* cited by examiner

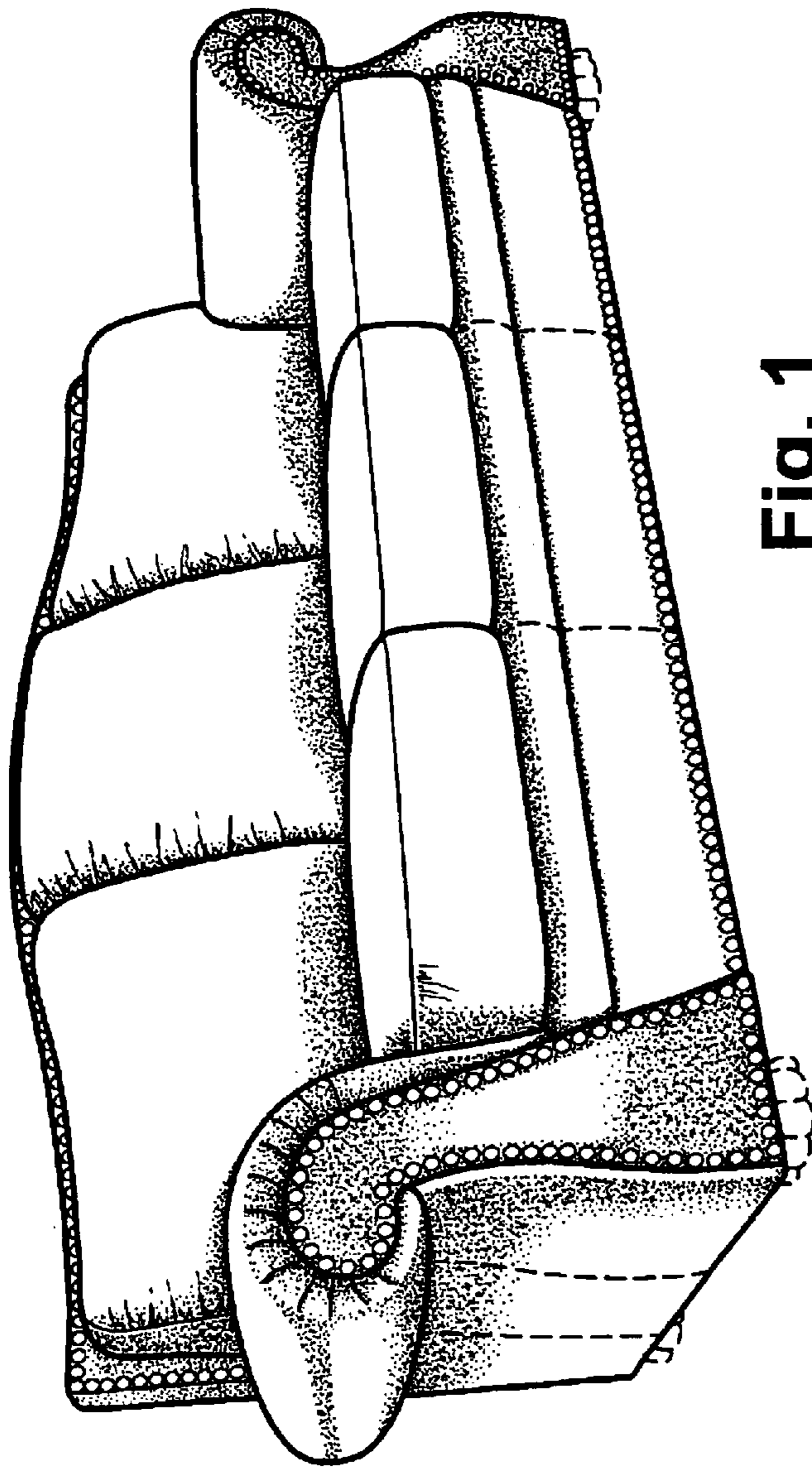

Fig. 1

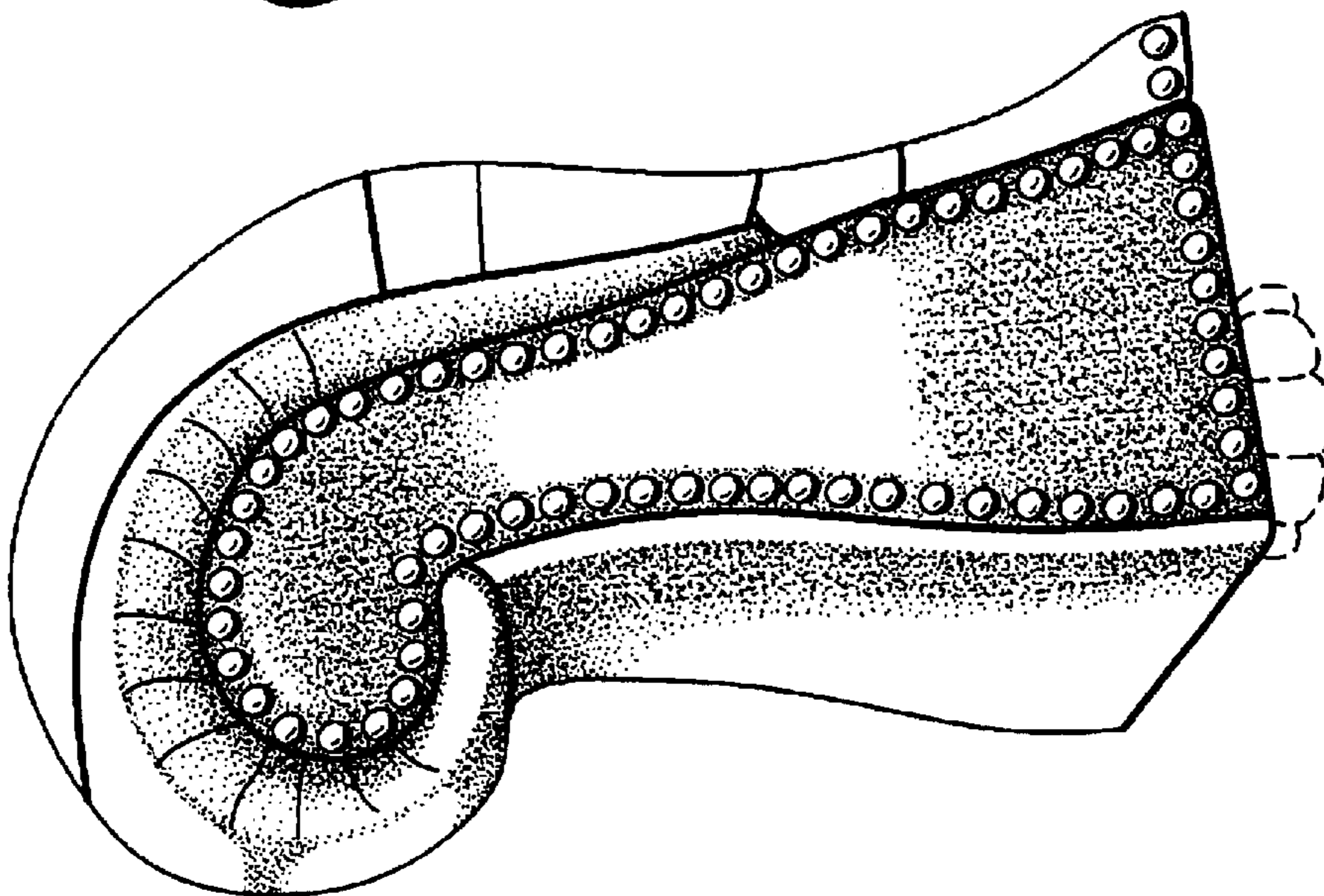

Fig. 2

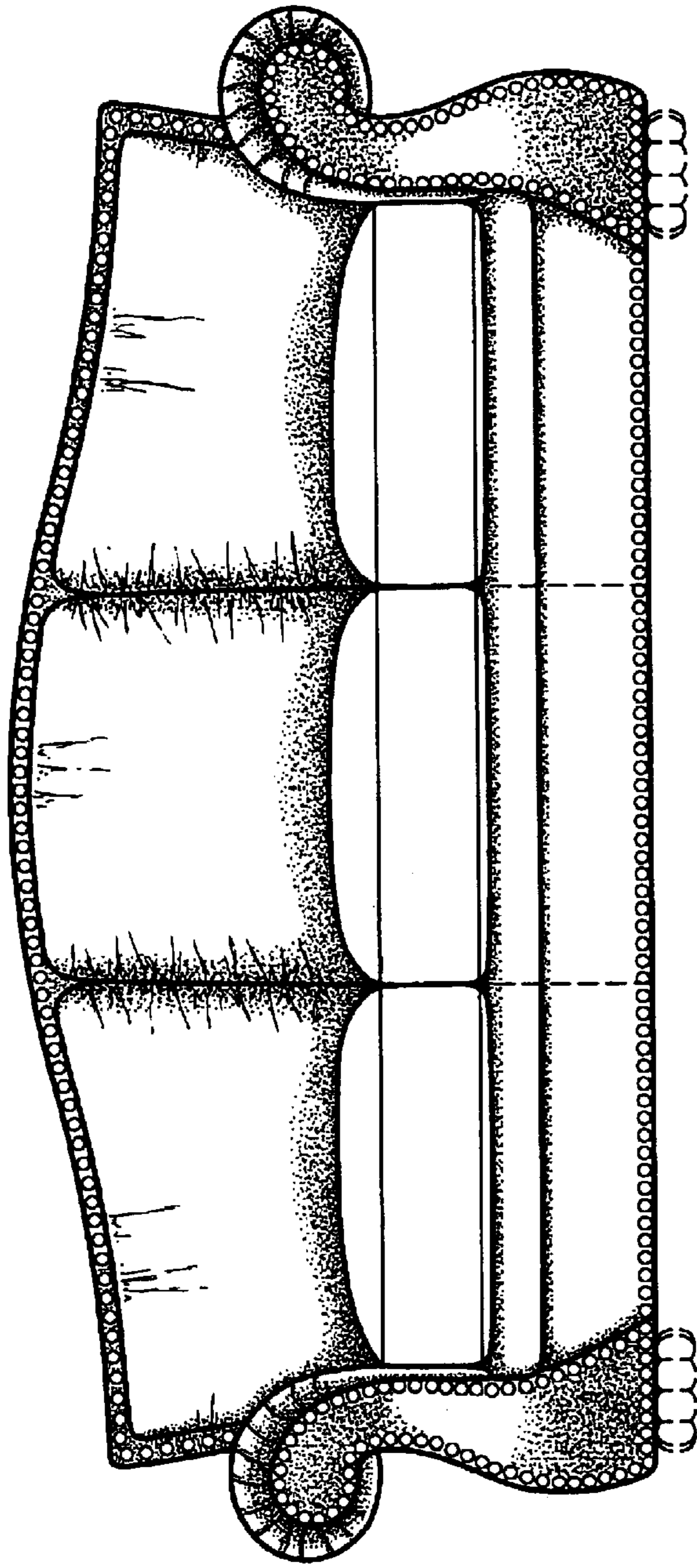

Fig. 3

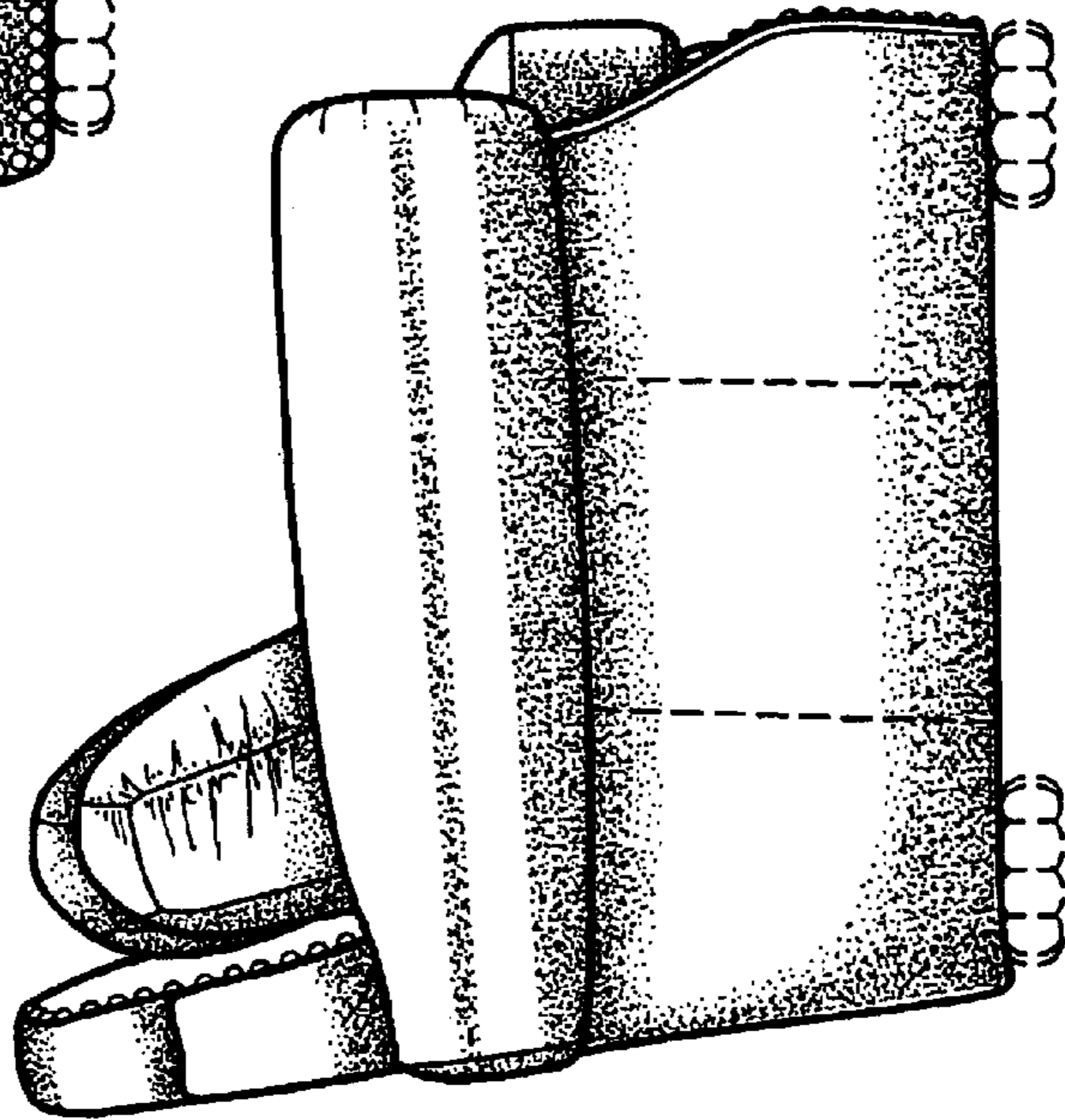

Fig. 4

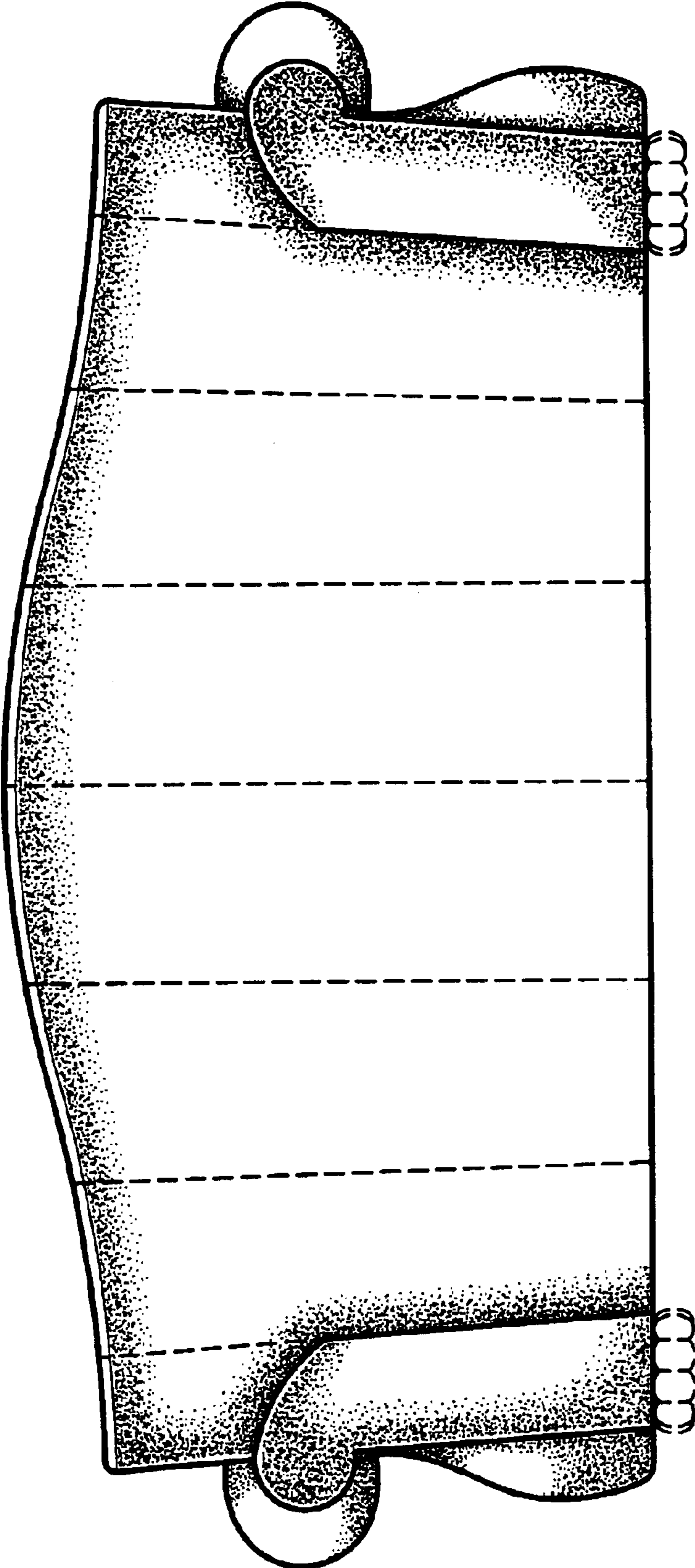

Fig. 5

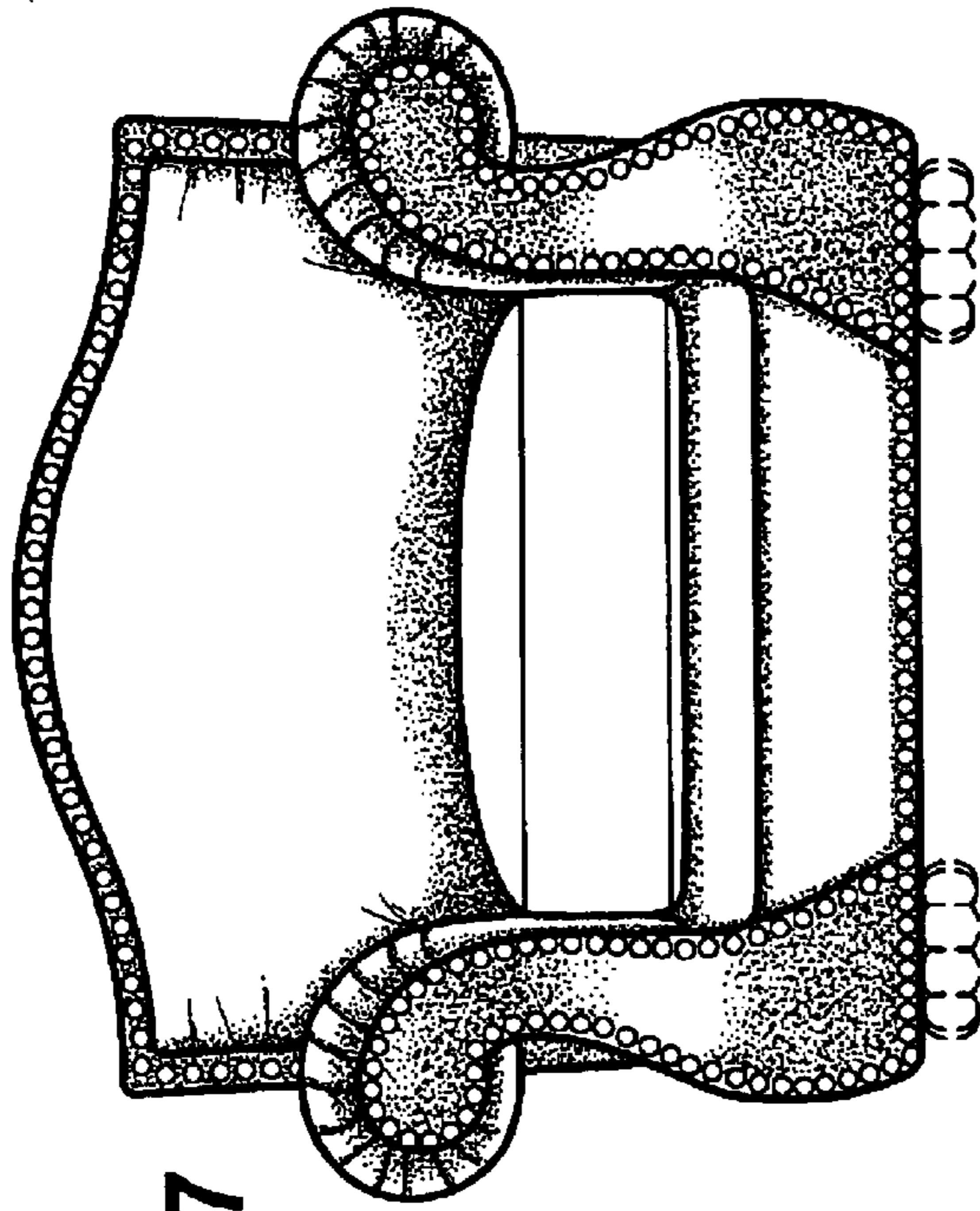

Fig. 7

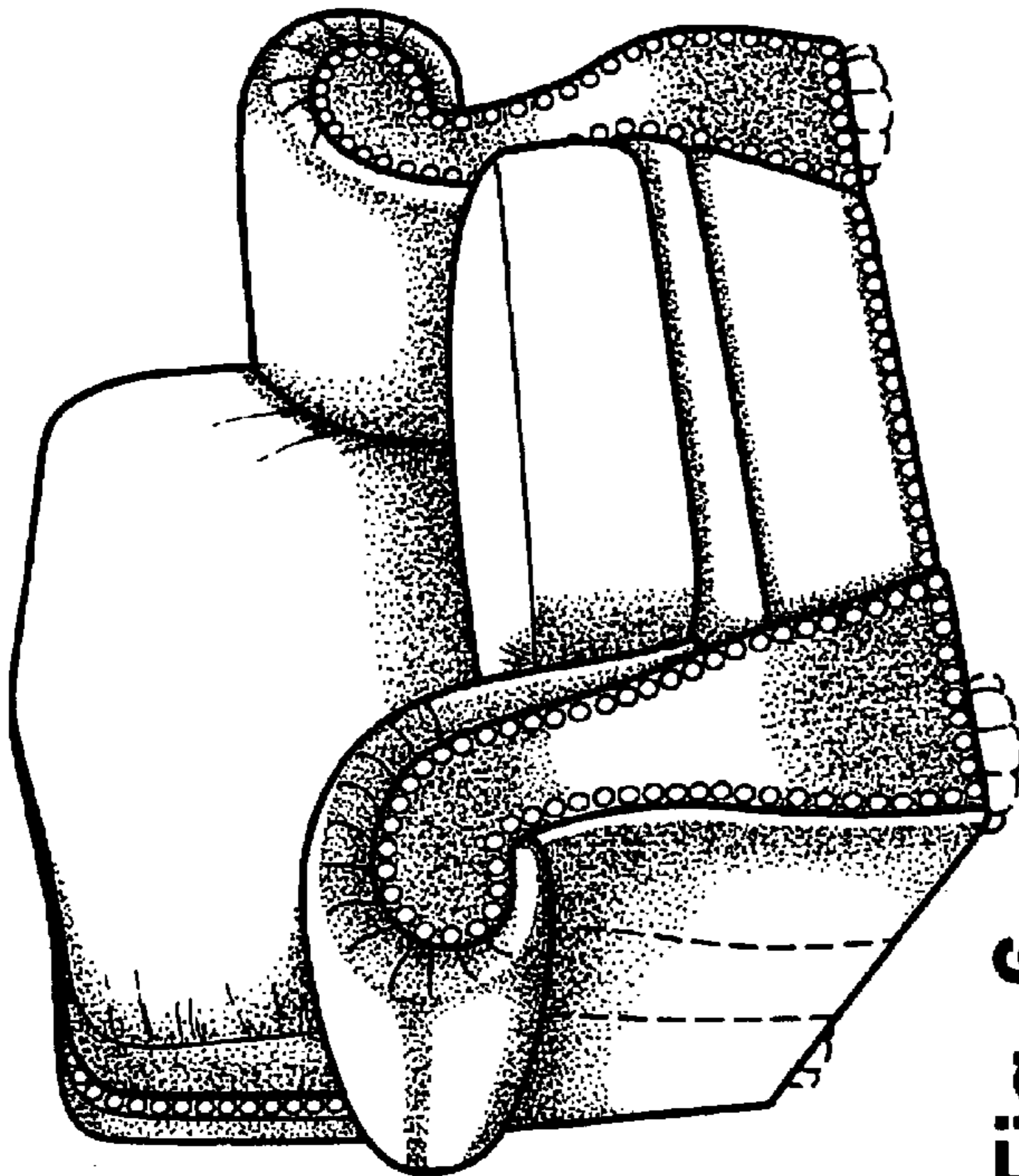

Fig. 6

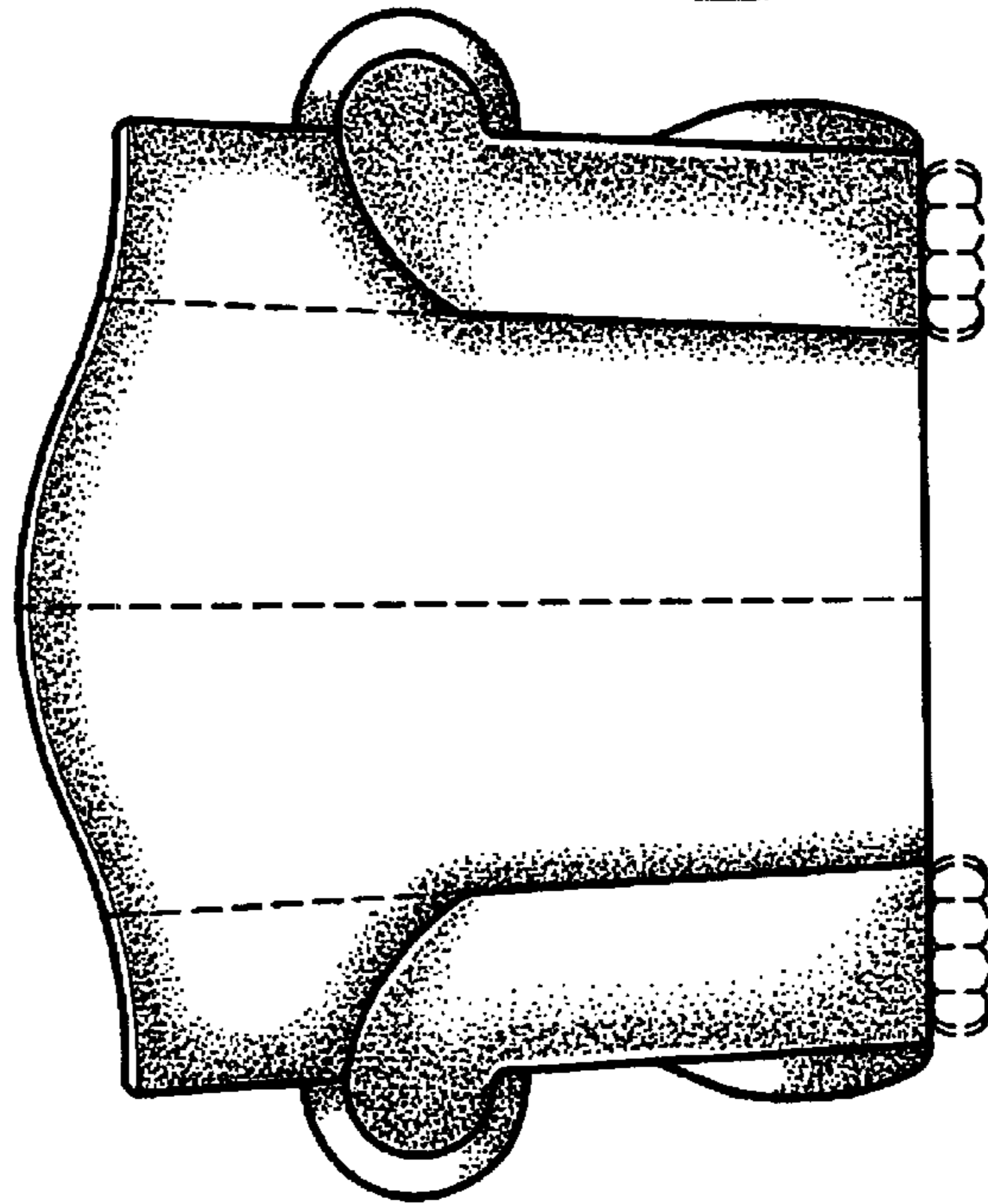

Fig. 8