

US00D495137S1

(12) **United States Design Patent** (10) **Patent No.:** **US D495,137 S**  
**Lee** (45) **Date of Patent:** **\*\* Aug. 31, 2004**

(54) **TOOTHBRUSH HOLDER** 5,095,924 A 3/1992 Stanfield  
 D328,816 S \* 8/1992 Cook et al. .... D3/300  
 (76) Inventor: **Xiong Lee**, 954 Audubon La., Aurora, IL (US) 60506 5,375,711 A \* 12/1994 Bree et al. .... 206/362.2  
 D389,686 S 1/1998 Drage  
 D408,186 S 4/1999 Bowers  
 (\*\*) Term: **14 Years** 5,960,801 A \* 10/1999 Vermooten et al. .... 132/308  
 D457,718 S \* 5/2002 McDonald ..... D3/205

(21) Appl. No.: **29/189,161**

\* cited by examiner

(22) Filed: **Aug. 29, 2003**

*Primary Examiner*—Philip S. Hyder

(51) **LOC (7) Cl.** ..... **03-01**

(57) **CLAIM**

(52) **U.S. Cl.** ..... **D3/294; D3/205**

(58) **Field of Search** ..... D3/203, 205, 294;  
D6/534; 206/362.2, 368; 312/206; 132/308

The ornamental design for a toothbrush holder, as shown and described.

(56) **References Cited**

**DESCRIPTION**

**U.S. PATENT DOCUMENTS**

1,618,027 A 2/1927 Vogler  
 D111,410 S 9/1938 Stanton  
 2,608,294 A 8/1952 Ward  
 2,673,641 A \* 3/1954 Estrada ..... 206/362.2  
 2,815,057 A \* 12/1957 Tupper ..... 220/796  
 3,884,635 A 5/1975 Sloan  
 5,076,428 A \* 12/1991 Shaw ..... 206/362.2  
 D323,090 S \* 1/1992 Santarelli et al. .... D6/534  
 D324,792 S \* 3/1992 McElroy ..... D6/528

FIG. 1 is a front elevational view of a toothbrush holder showing my new design;  
 FIG. 2 is a rear elevational view thereof;  
 FIG. 3 is a side view, taken from the left side of FIG. 1, the right side view being a mirror image thereof;  
 FIG. 4 is a top plan view thereof;  
 FIG. 5 is a bottom plan view thereof; and,  
 FIG. 6 is a perspective view thereof.

**1 Claim, 3 Drawing Sheets**

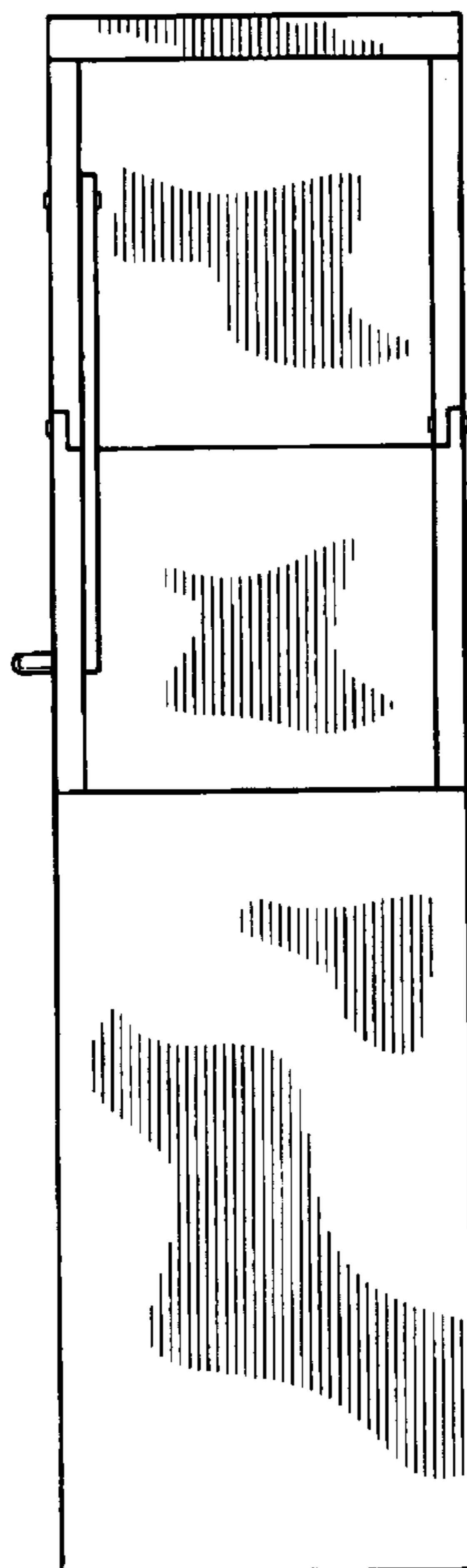

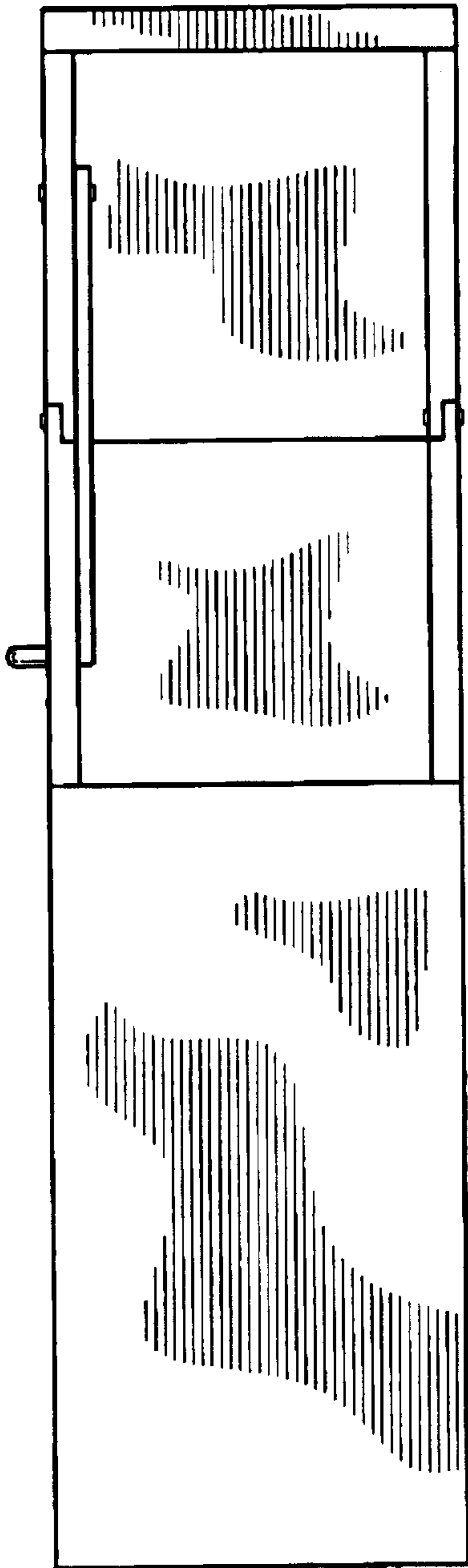

FIG.1

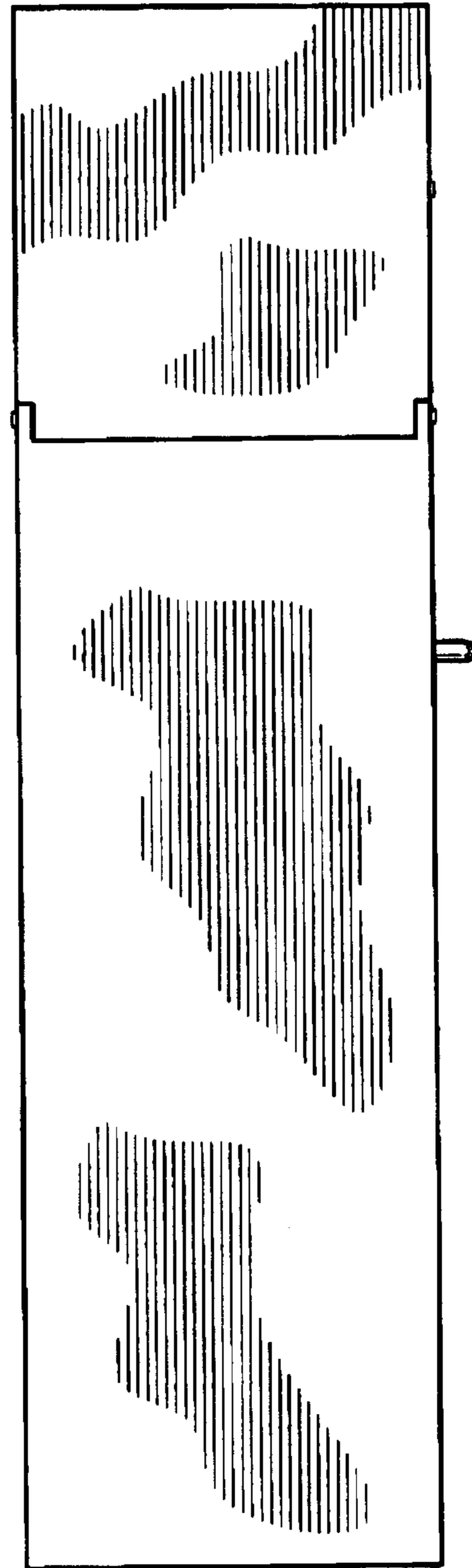

FIG.2

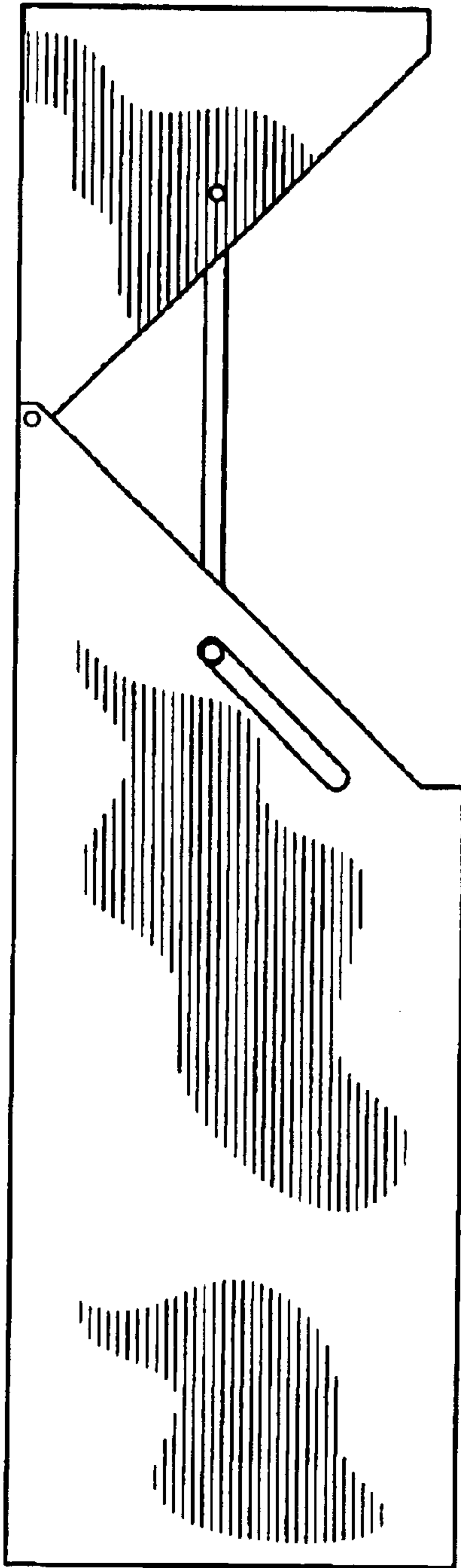

FIG. 3

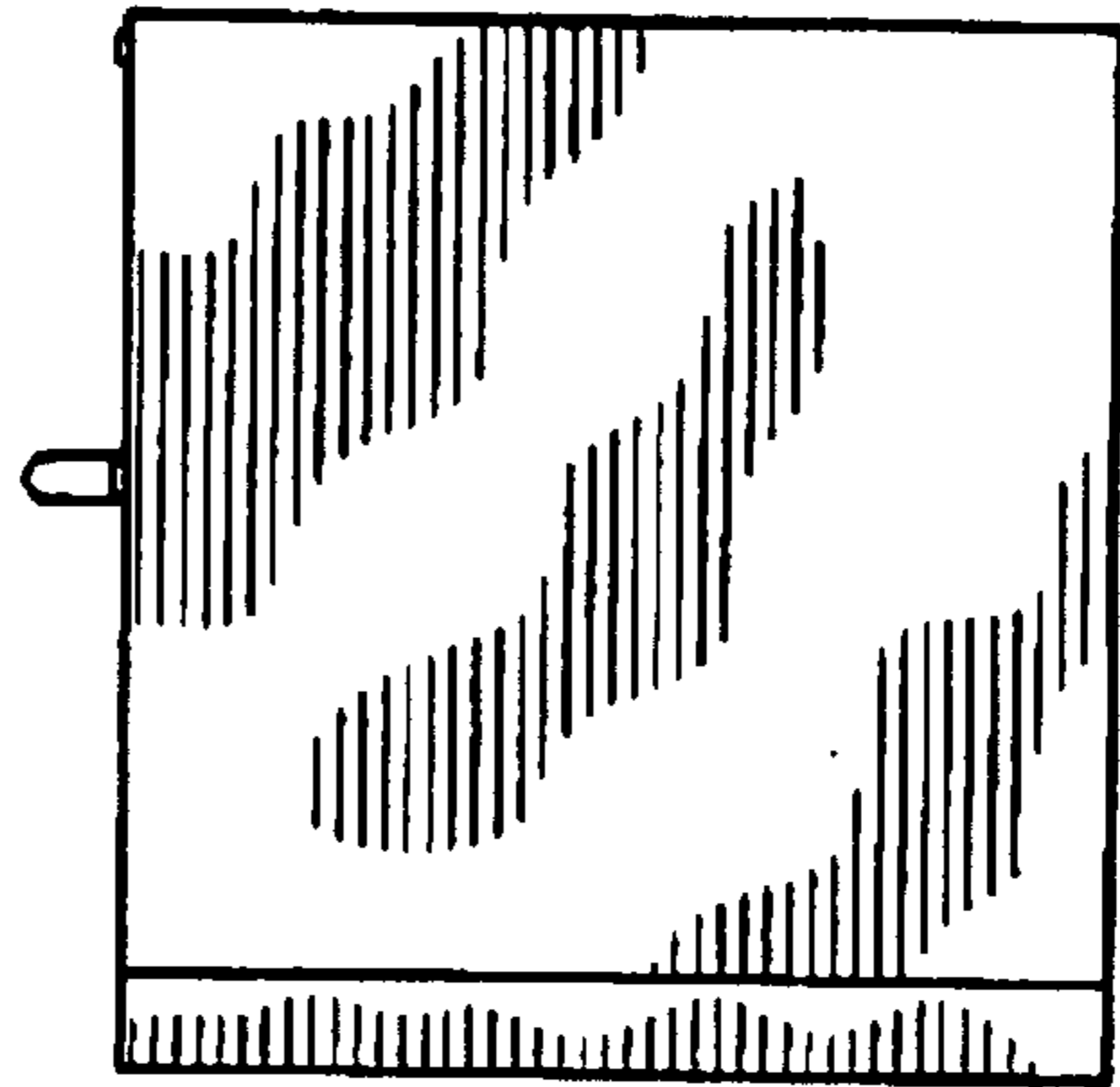

FIG. 4

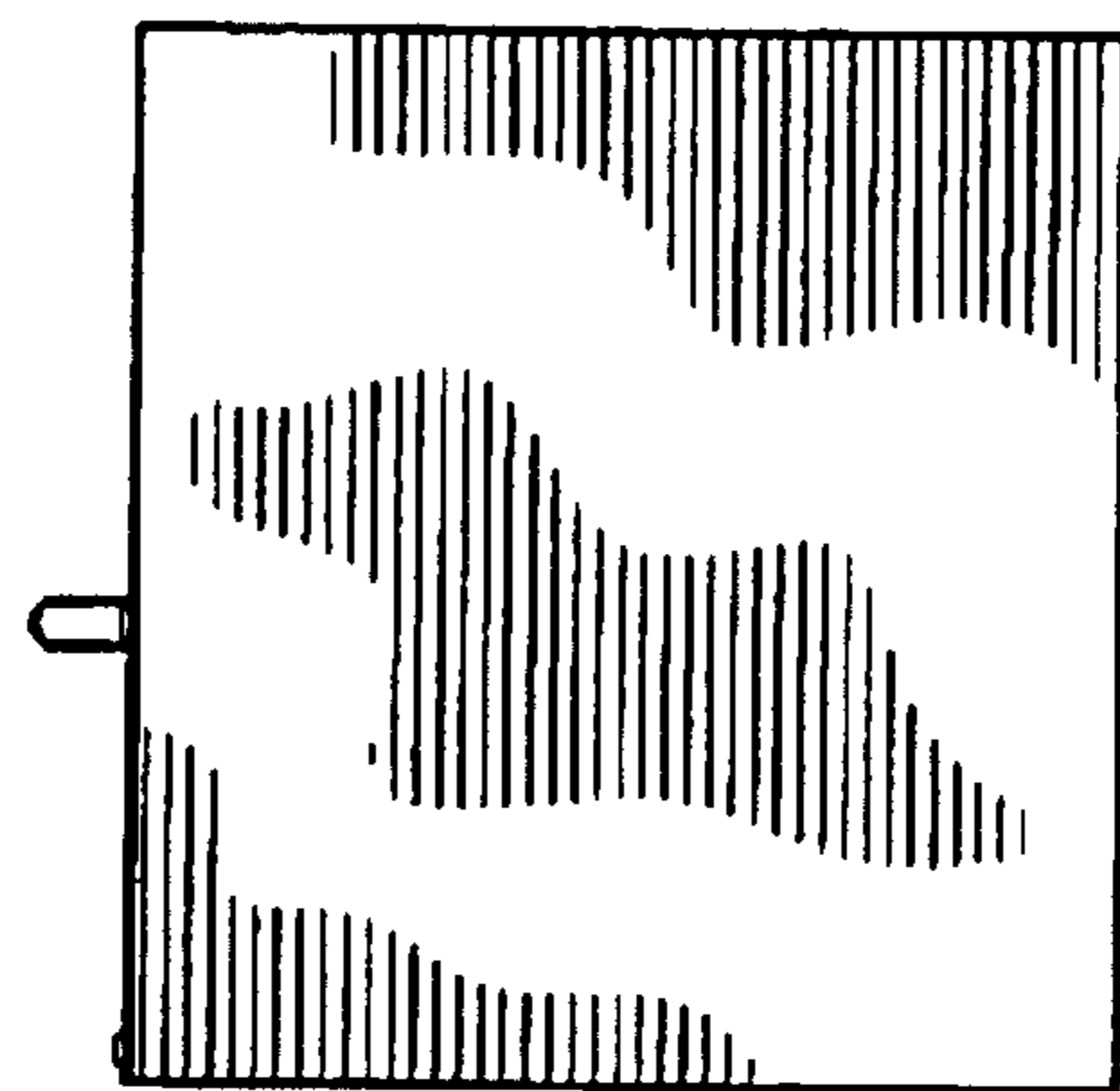

FIG. 5

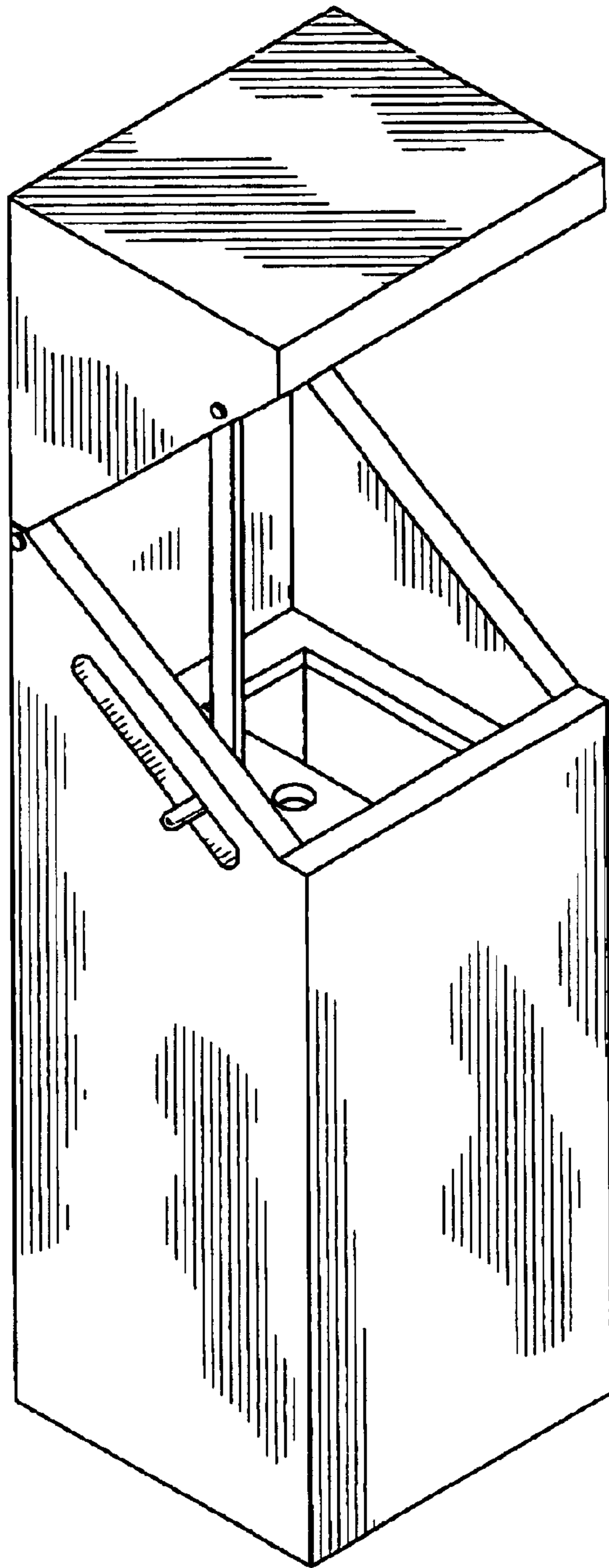

FIG.6