

US00D495078S1

(12) **United States Design Patent**
Galli

(10) **Patent No.:** **US D495,078 S**

(45) **Date of Patent:** **** Aug. 24, 2004**

(54) **FLASHLIGHT**

(57) **CLAIM**

(76) **Inventor:** **Robert D. Galli**, 8176 Horseshoe Bend
La., Las Vegas, NV (US) 09113

The ornamental design for a flashlight, as shown and
described.

(**) **Term:** **14 Years**

DESCRIPTION

(21) **Appl. No.:** **29/195,360**

FIG. 1 is a perspective view of a flashlight, showing my new
design;

(22) **Filed:** **Dec. 9, 2003**

FIG. 2 is a top plan view thereof;

(51) **LOC (7) Cl. 26-02**

FIG. 3 is a bottom view thereof;

(52) **U.S. Cl. D26/49**

FIG. 4 is a front view thereof;

(58) **Field of Search D26/37-50; 362/157,
362/158, 171-174, 183-208**

FIG. 5 is a left side view thereof;

FIG. 6 is a rear view thereof;

FIG. 7 is a right side view thereof;

FIG. 8 is a perspective view of an alternate embodiment of
my new flashlight design;

(56) **References Cited**

FIG. 9 is a top view of FIG. 8;

U.S. PATENT DOCUMENTS

FIG. 10 is a bottom view of FIG. 8;

D451,224 S * 11/2001 Yang D26/49

FIG. 11 is a front view of FIG. 8;

D463,595 S * 9/2002 Cheong et al. D26/49

FIG. 12 is a left side view of FIG. 8;

D481,816 S * 11/2003 Sharrah et al. D26/49

FIG. 13 is a rear view of FIG. 8; and,

D488,876 S * 4/2004 Kotani D26/49

FIG. 14 is a right side view of FIG. 8.

* cited by examiner

The subject matter illustrated in dashed lines in FIGS. 1
through 14 has been shown for illustrative purposes only and
forms no part of the claimed design.

Primary Examiner—Marcus A. Jackson

1 Claim, 14 Drawing Sheets

(74) *Attorney, Agent, or Firm*—Barlow, Josephs & Holmes,
Ltd.

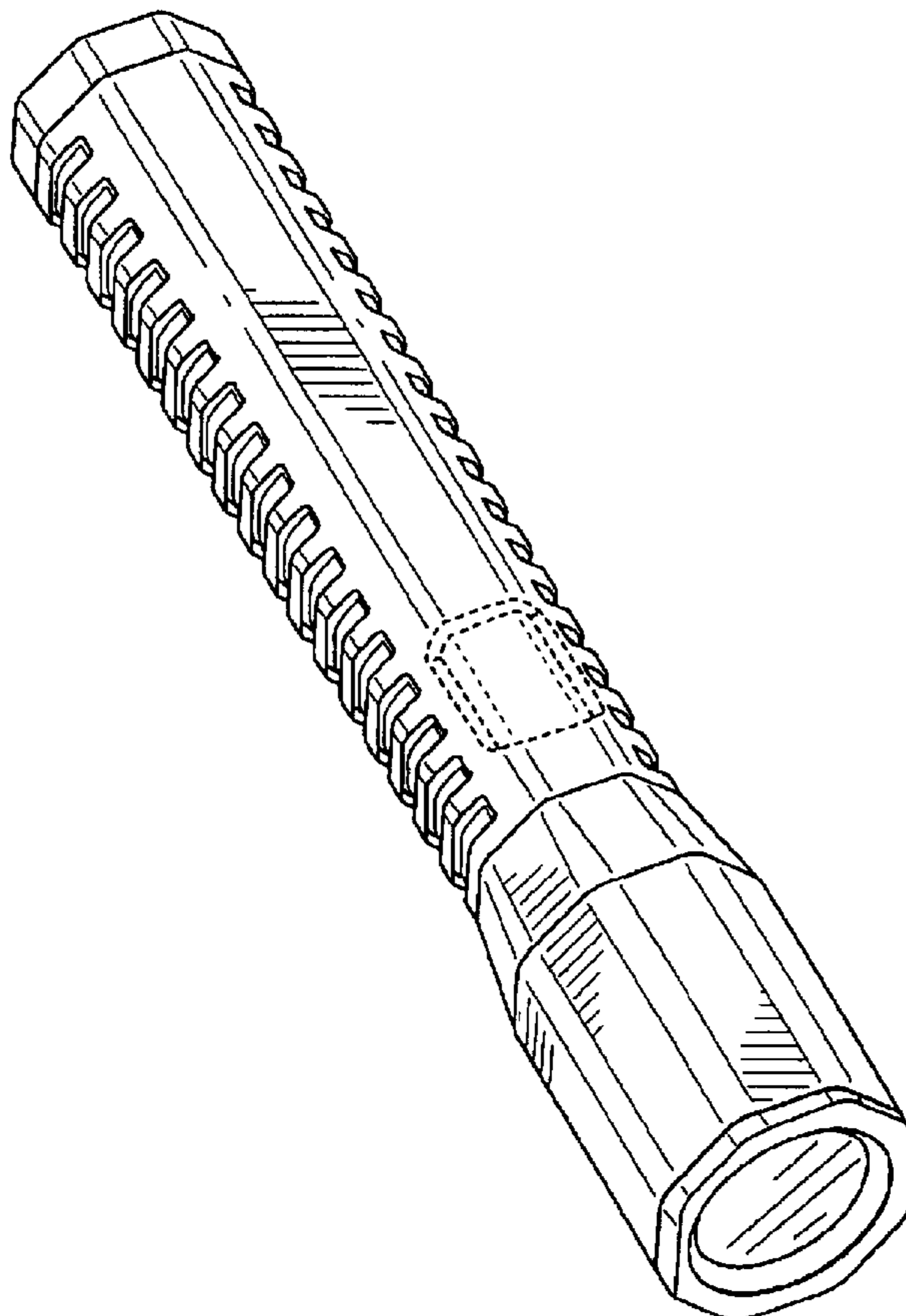

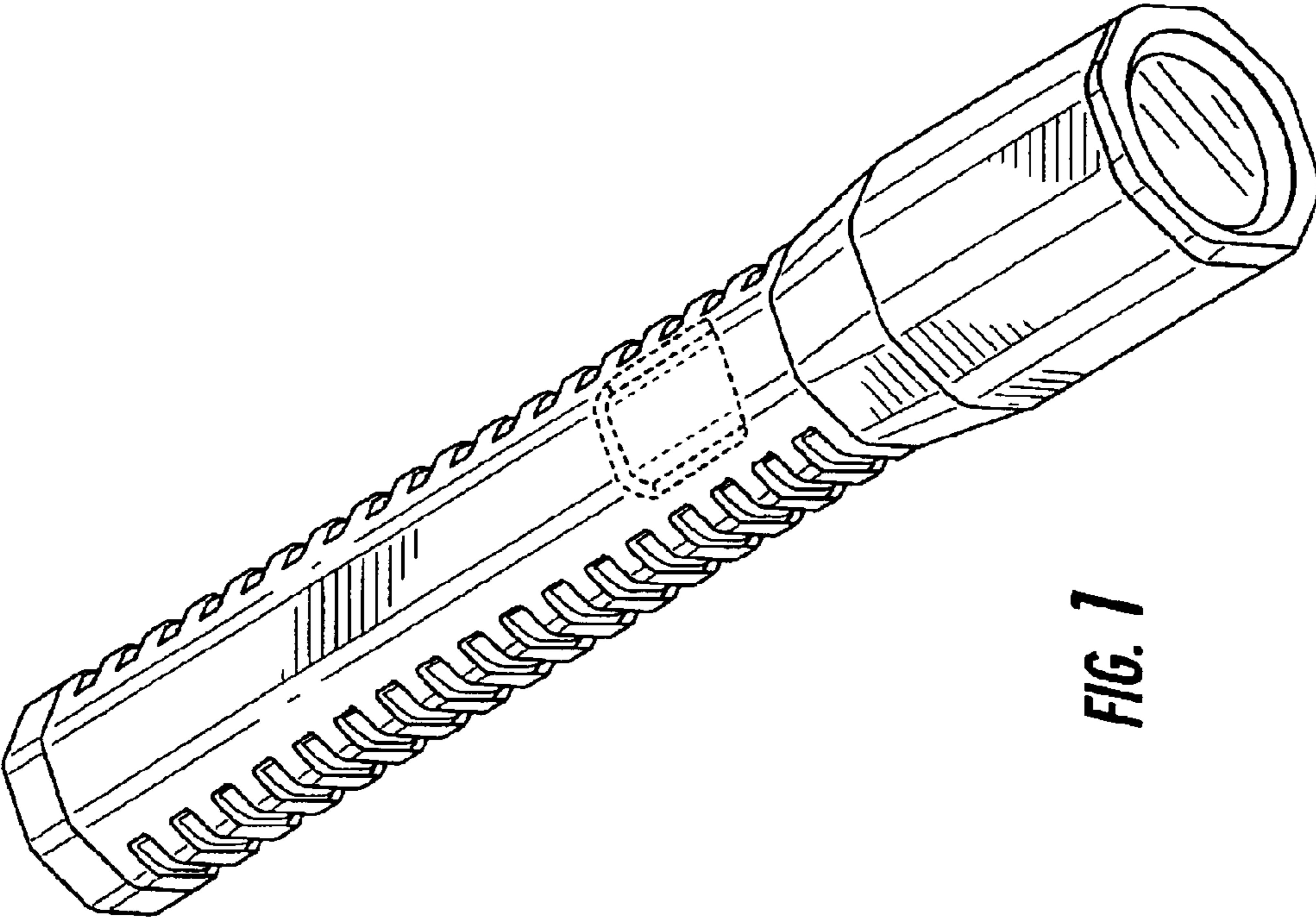

FIG. 1

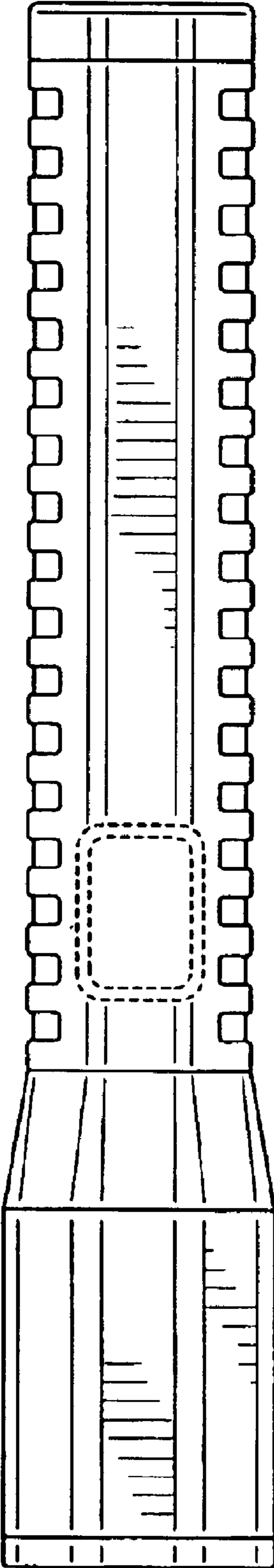

FIG. 2

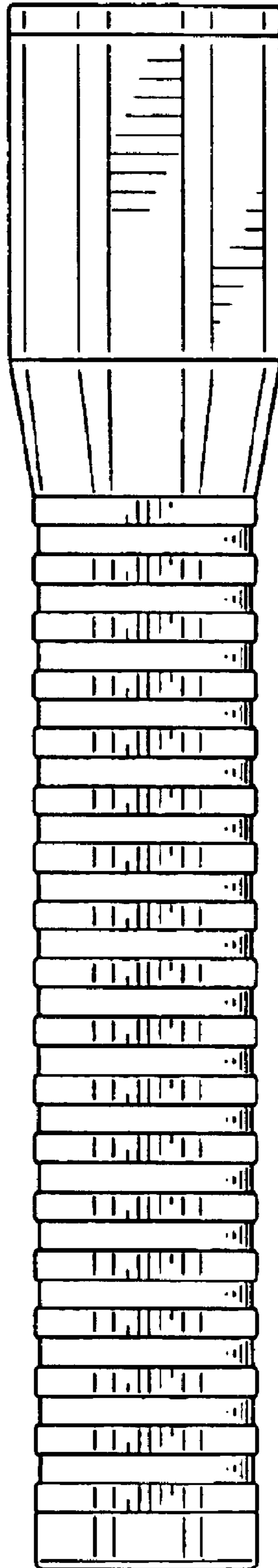

FIG. 3

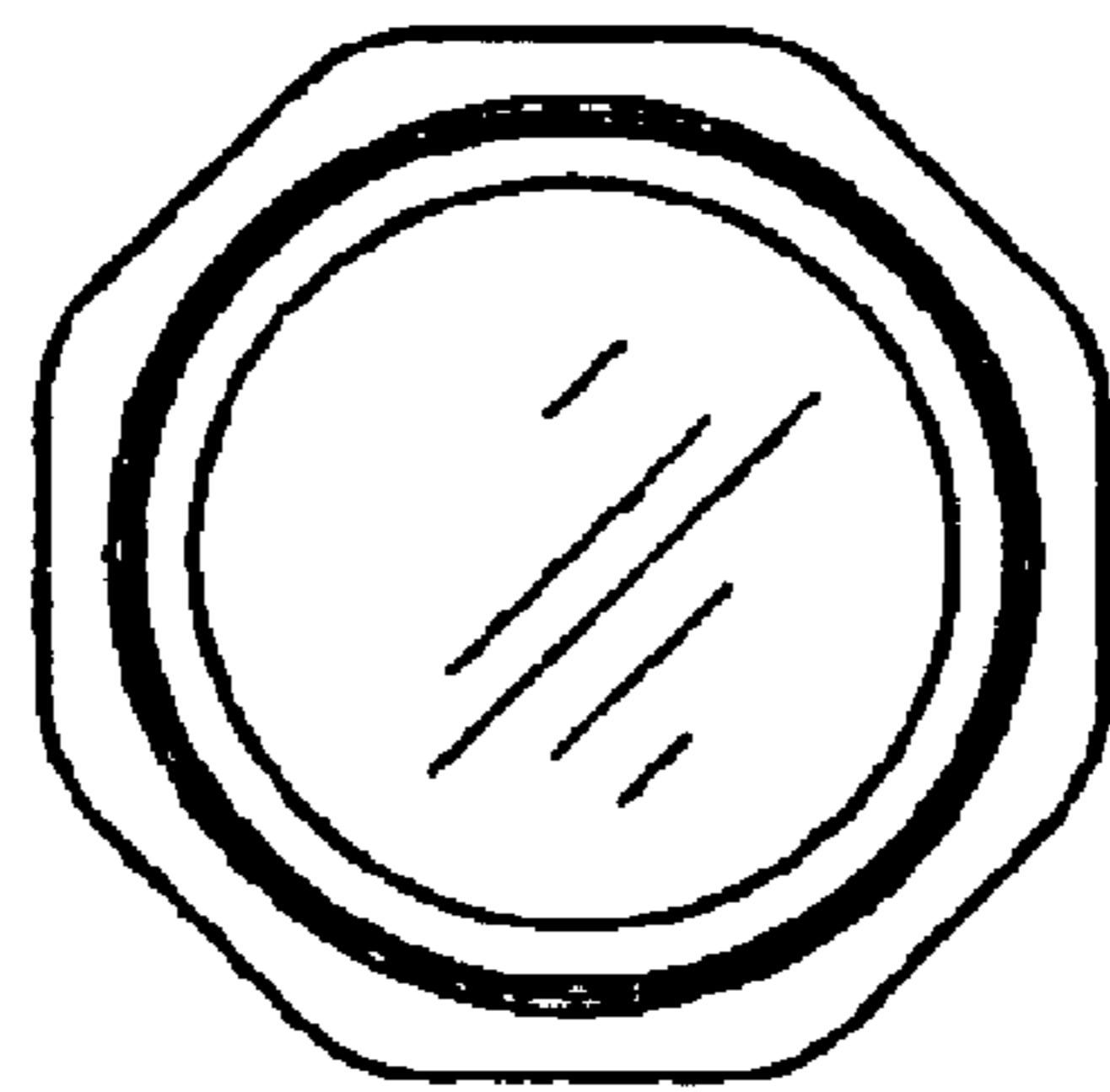

FIG. 4

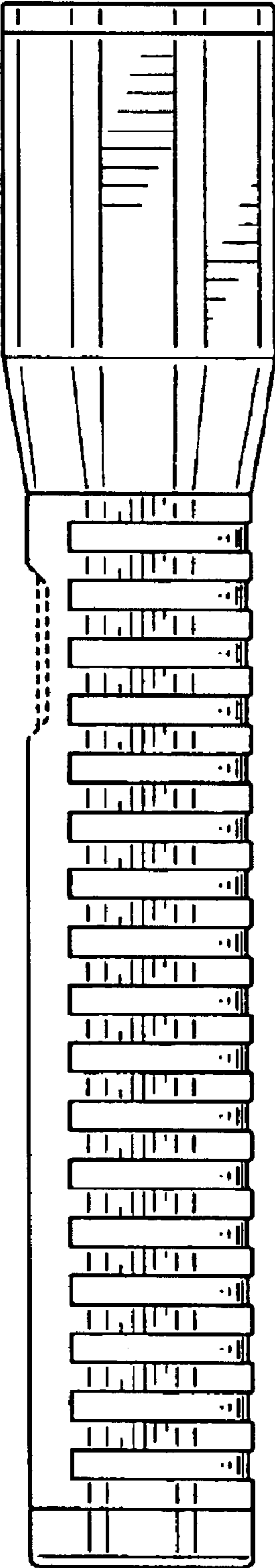

FIG. 5

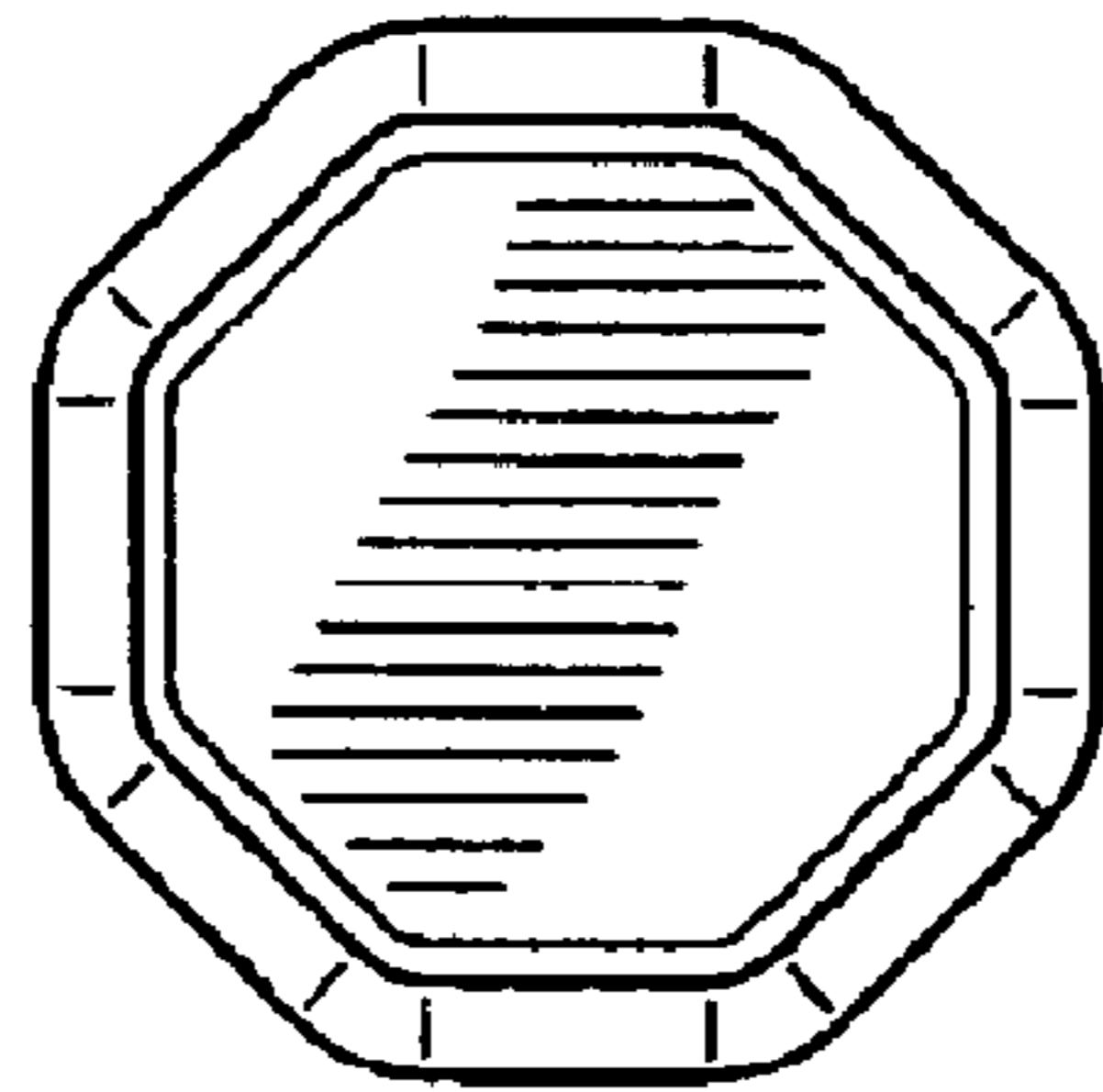

FIG. 6

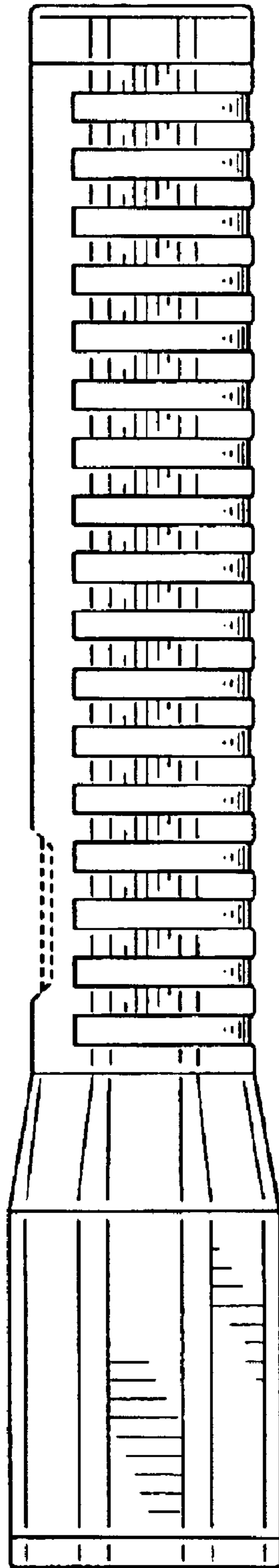

FIG. 7

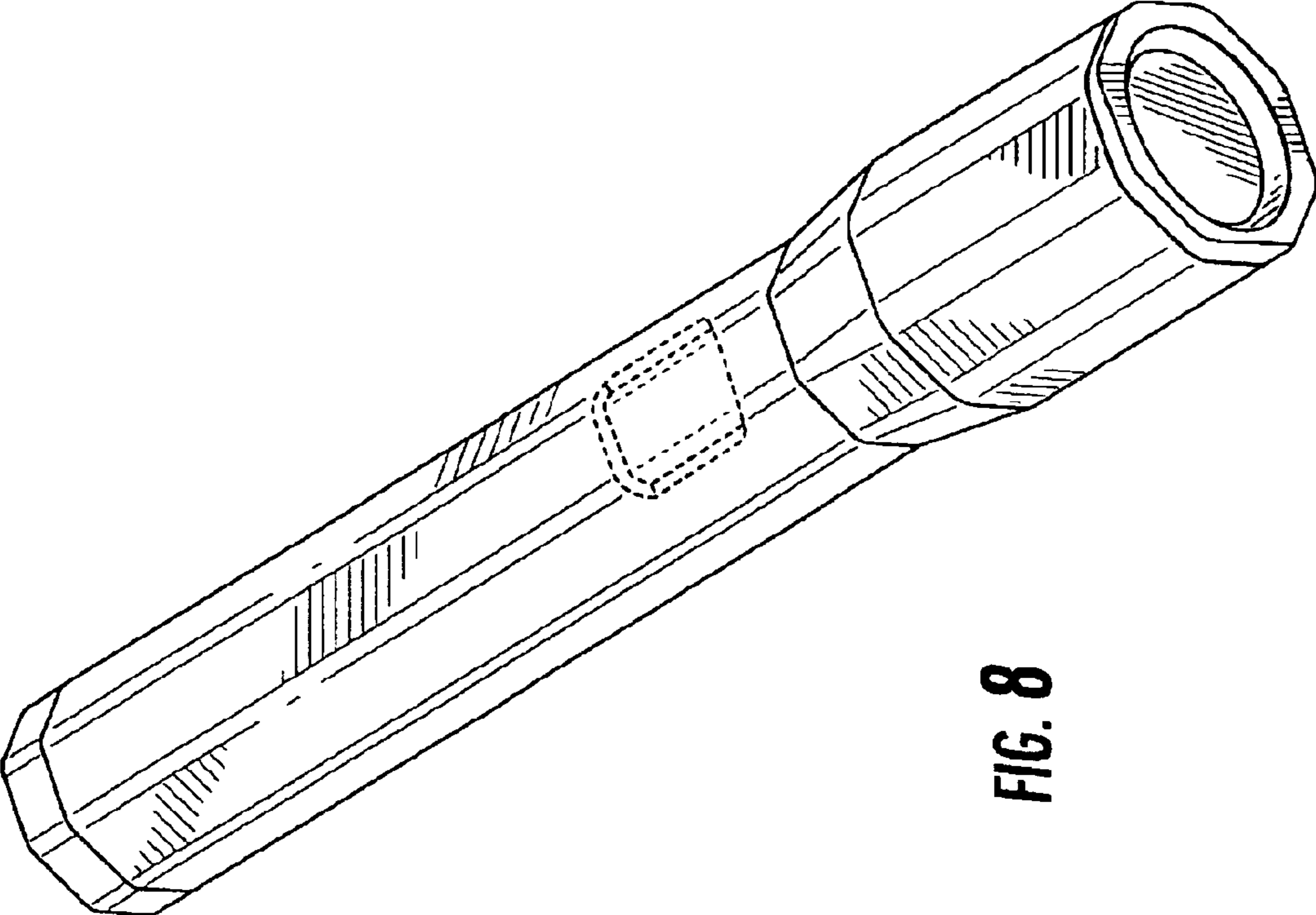

FIG. 8

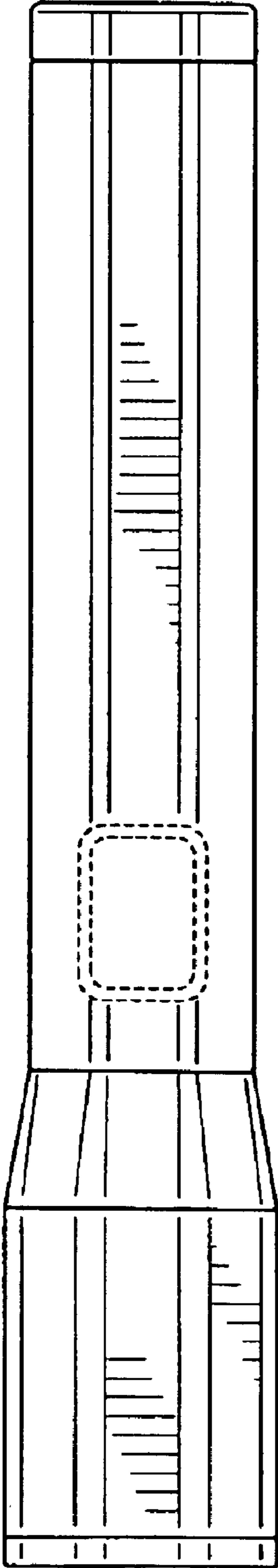

FIG. 9

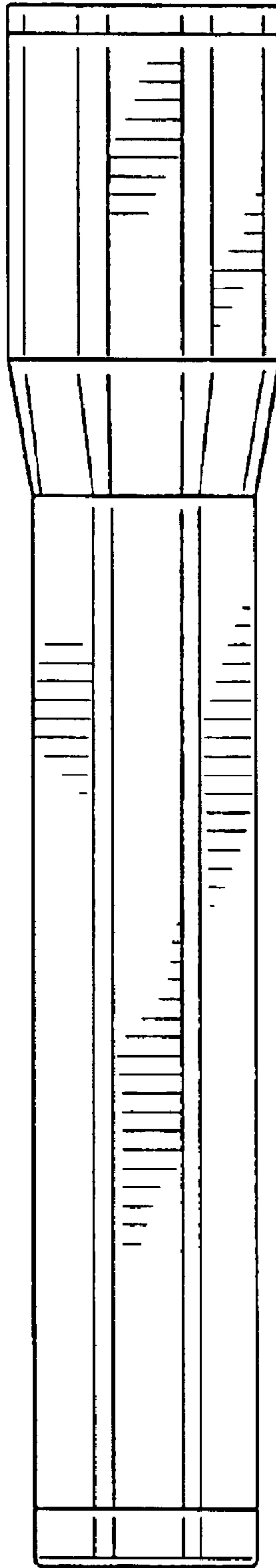

FIG. 10

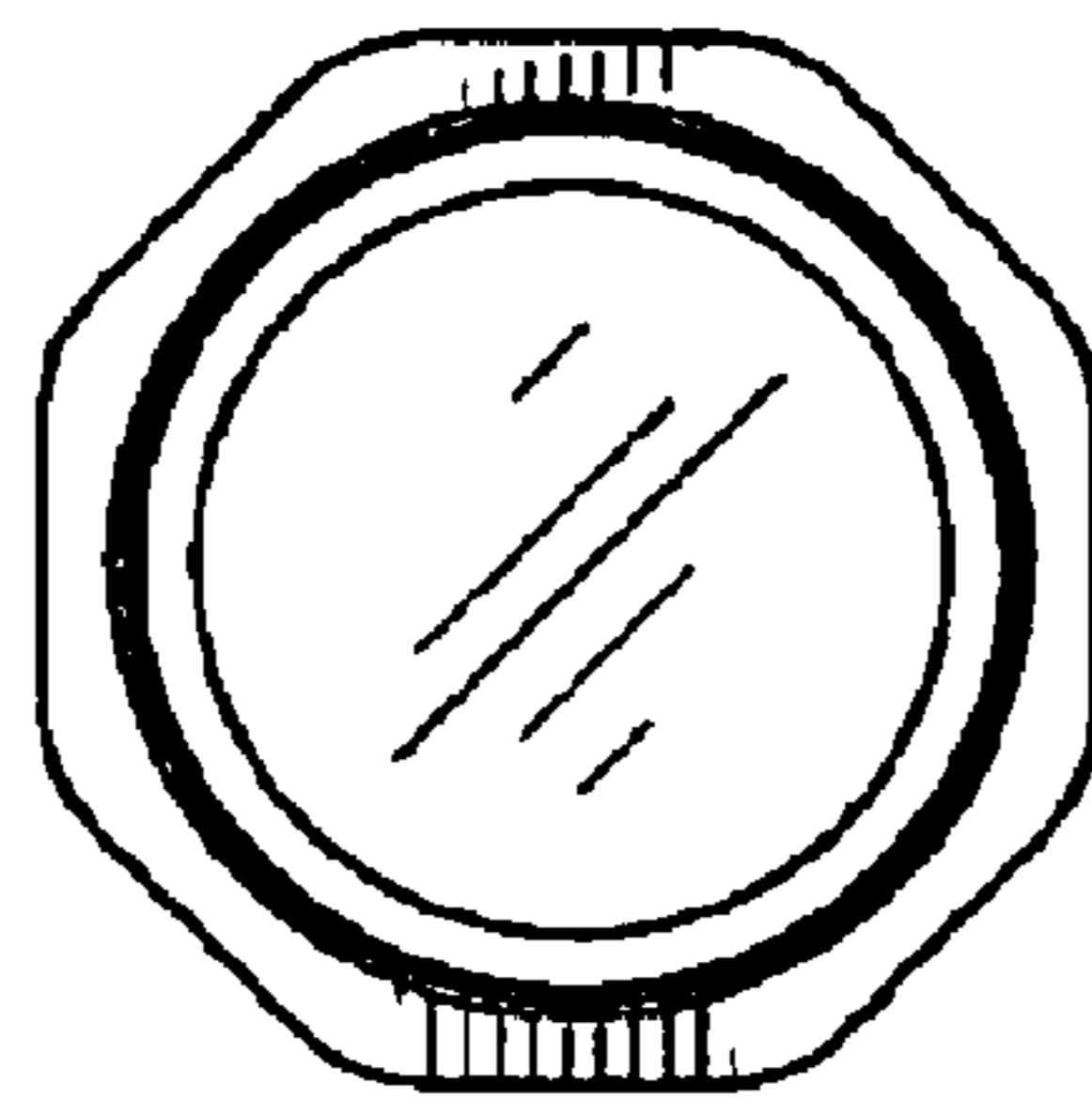

FIG. 11

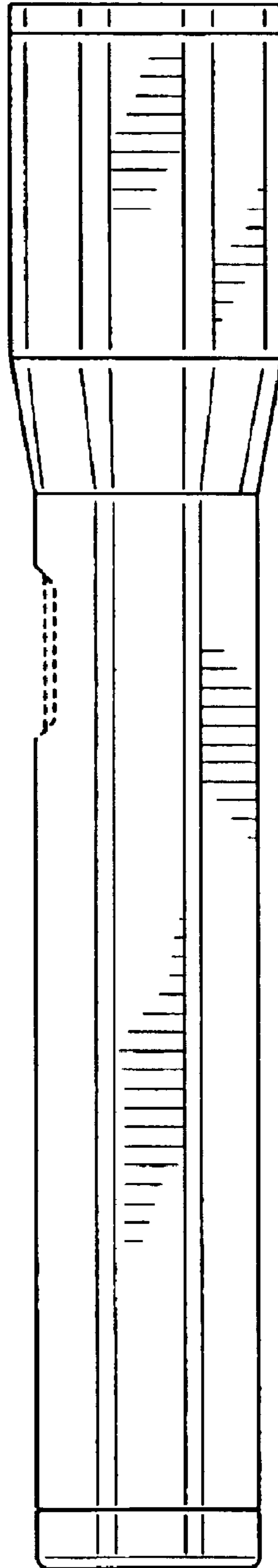

FIG. 12

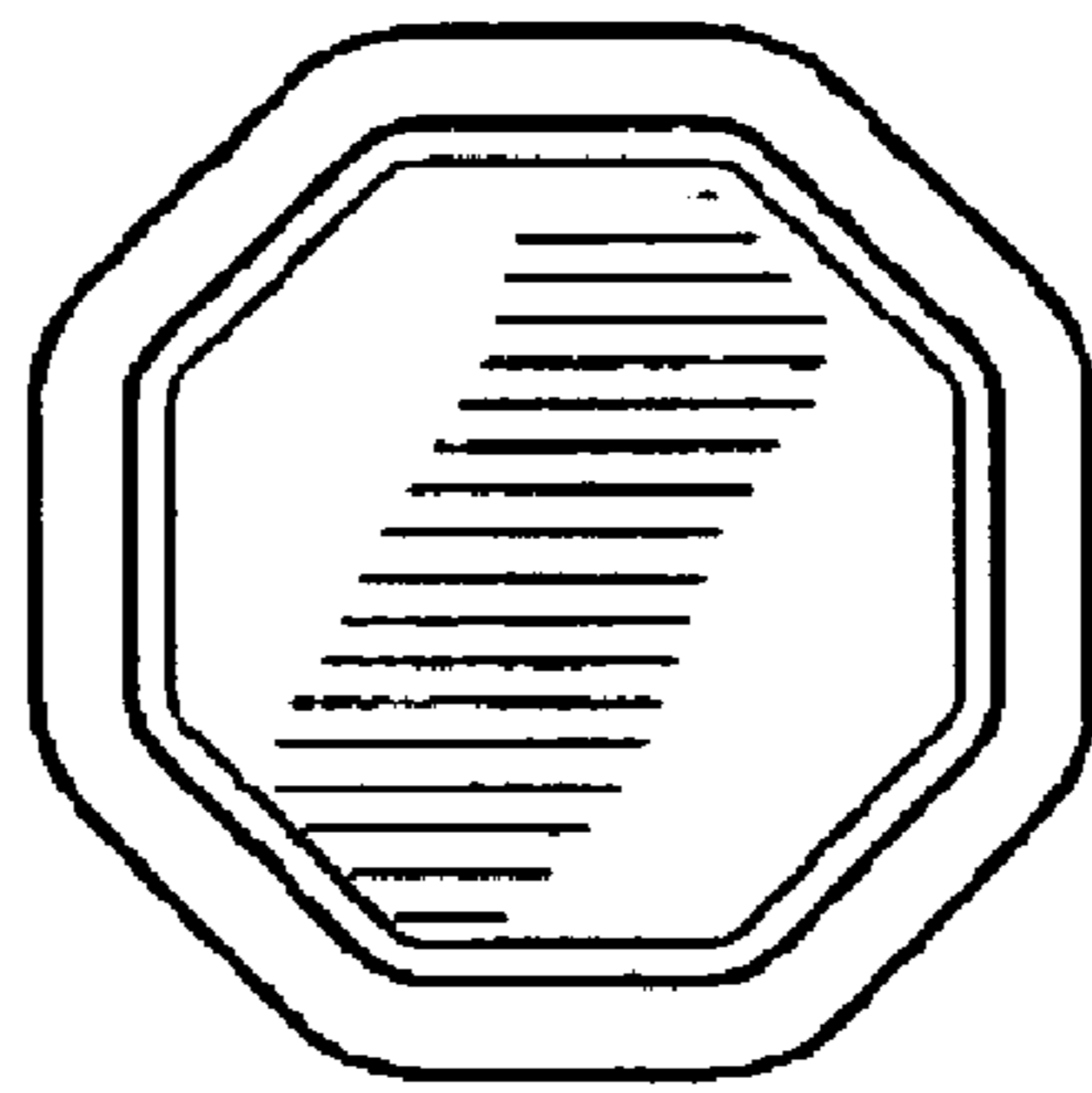

FIG. 13

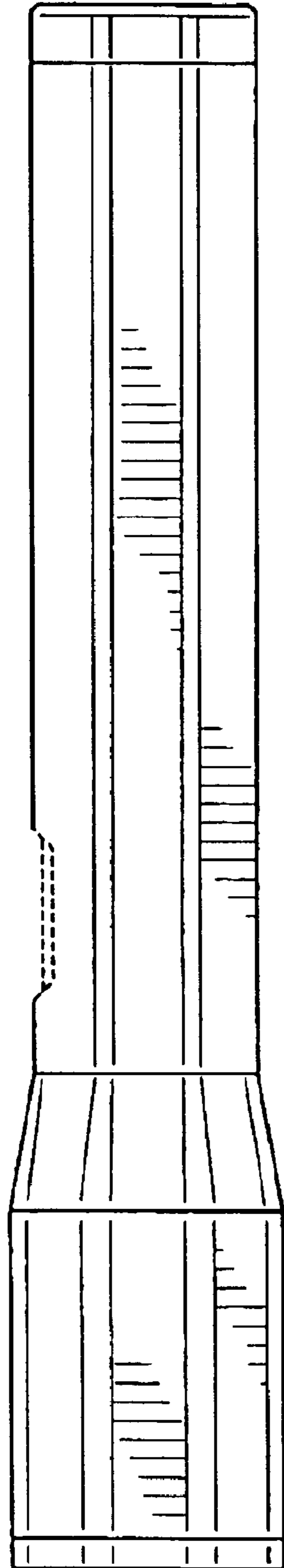

FIG. 14