

US00D495019S1

(12) **United States Design Patent**
Nathanson

(10) **Patent No.:** **US D495,019 S**
(45) **Date of Patent:** **** Aug. 24, 2004**

(54) **GOLF CLUB HEAD DESIGN**

D422,658 S * 4/2000 Besnard et al. D21/748

(75) Inventor: **Colin Nathanson**, Rancho Santa
Margarita, CA (US)

(73) Assignee: **Giant Golf Company**, Rancho Santa
Margarita, CA (US)

(**) Term: **14 Years**

(21) Appl. No.: **29/192,494**

(22) Filed: **Oct. 24, 2003**

(51) **LOC (7) Cl.** **21-02**

(52) **U.S. Cl.** **D21/748**

(58) **Field of Search** D21/747-751;
473/324-331, 350

(56) **References Cited**

U.S. PATENT DOCUMENTS

D240,841 S	*	8/1976	Solheim	D21/748
D353,644 S		12/1994	Hirsch et al.		
5,375,840 A		12/1994	Hirsch et al.		
D361,813 S	*	8/1995	Guibaud et al.	D21/748
D379,207 S	*	5/1997	Besnard et al.	D21/748

OTHER PUBLICATIONS

ATGOLF 1998-1999 Catalog, Arcadia, California.

* cited by examiner

Primary Examiner—Mitchell Siegel

(74) *Attorney, Agent, or Firm*—Stetina Brunda Garred &
Brucker

(57) **CLAIM**

The ornamental design for a golf club head design, as shown
and described.

DESCRIPTION

FIG. 1 is a top view of the invention;
FIG. 2 is a left side view of the invention;
FIG. 3 is a front view of the invention;
FIG. 4 is a bottom view of the invention;
FIG. 5 is a right side view of the invention;
FIG. 6 is a rear view of the invention; and,
FIG. 7 is a cross sectional view taken on line 7-7 of FIG.
3.

1 Claim, 2 Drawing Sheets

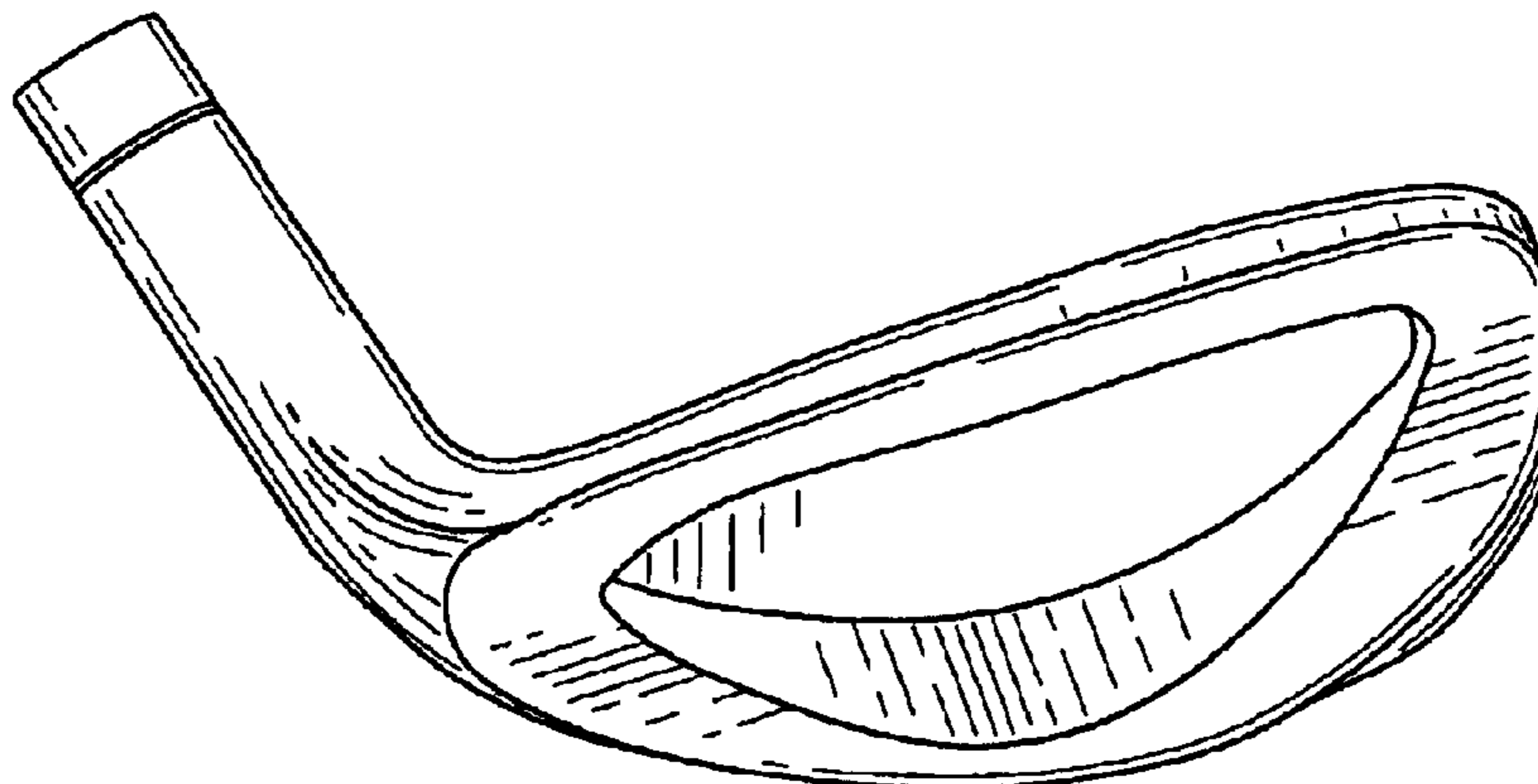
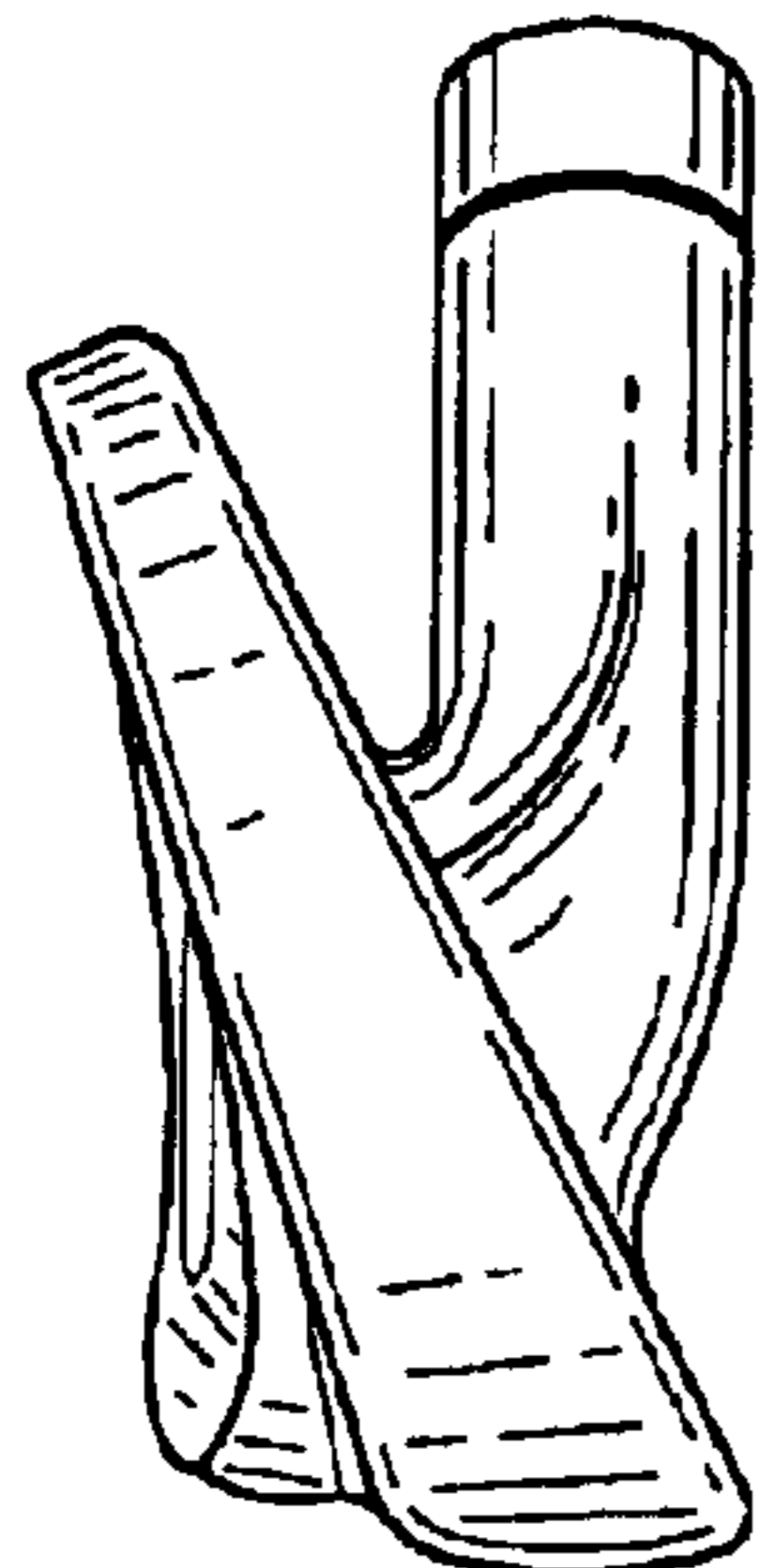

Fig. 1

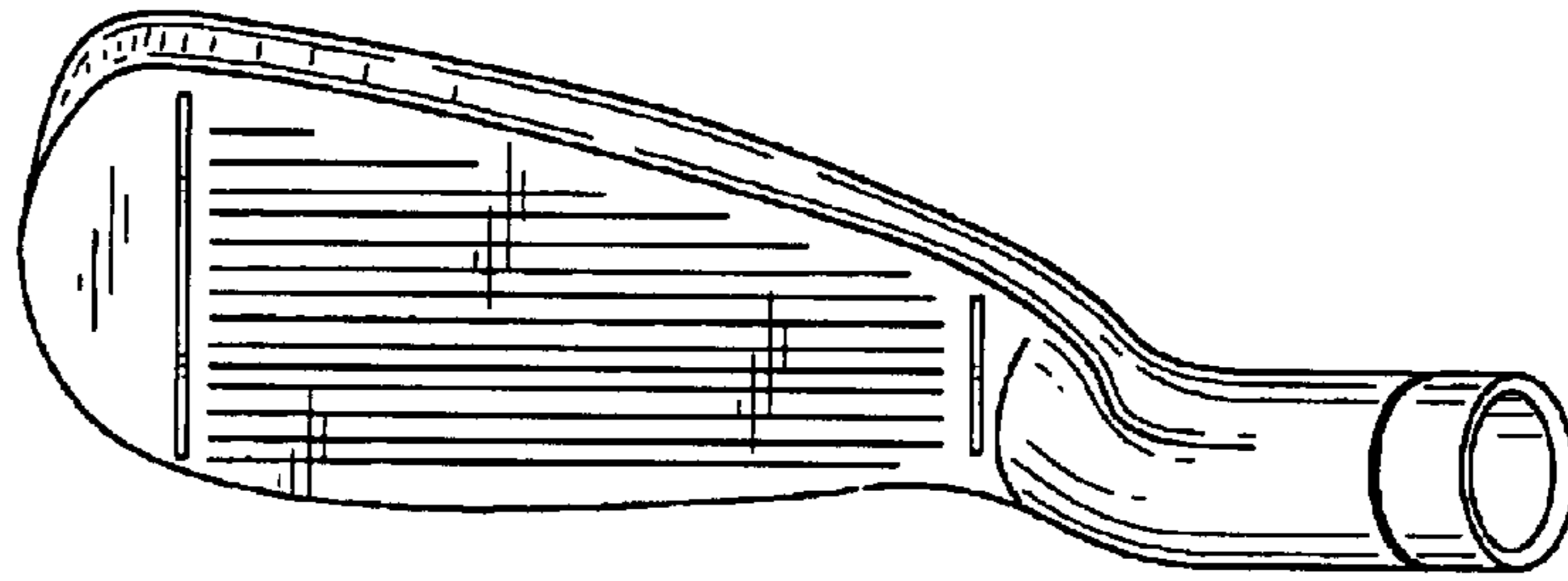

Fig. 2

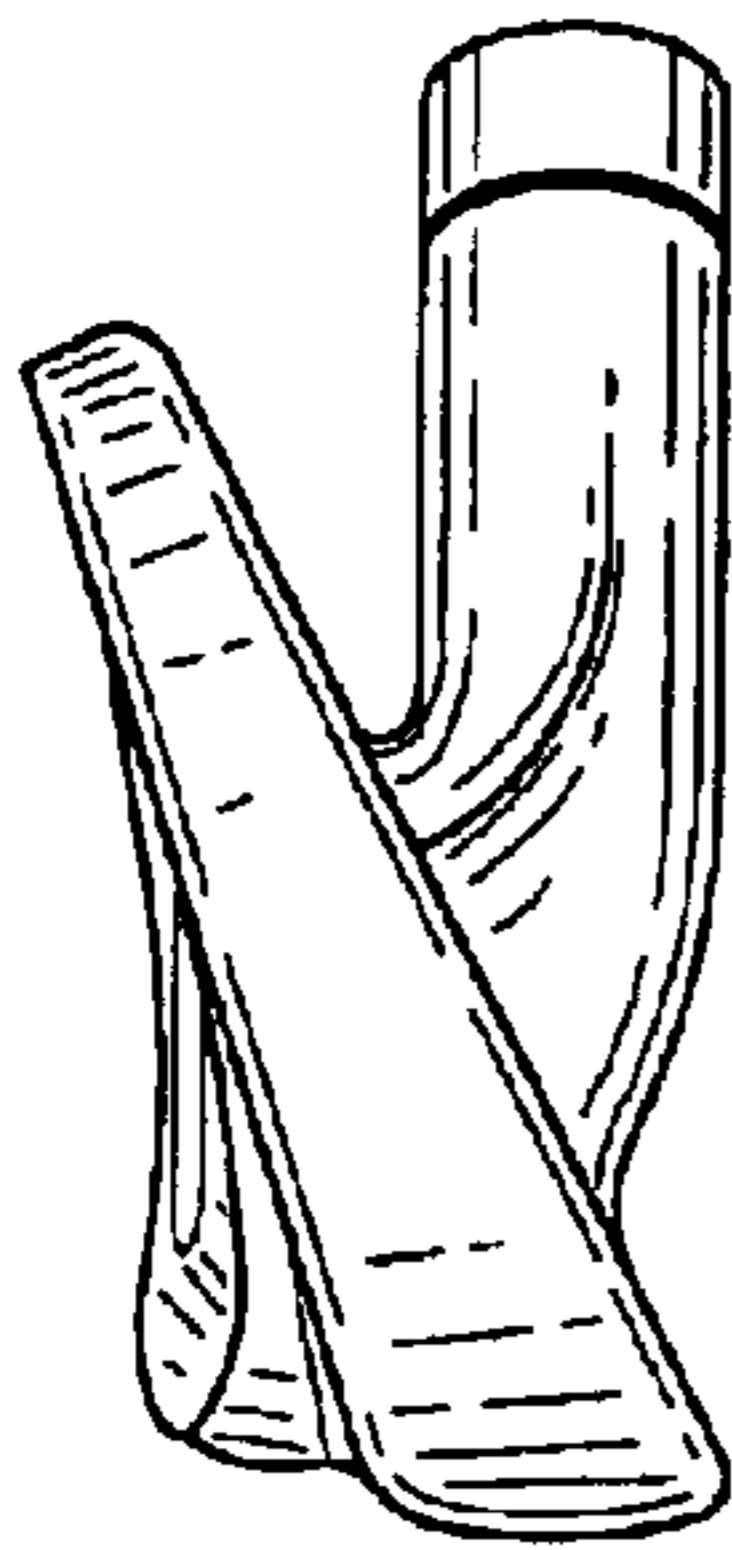

Fig. 3

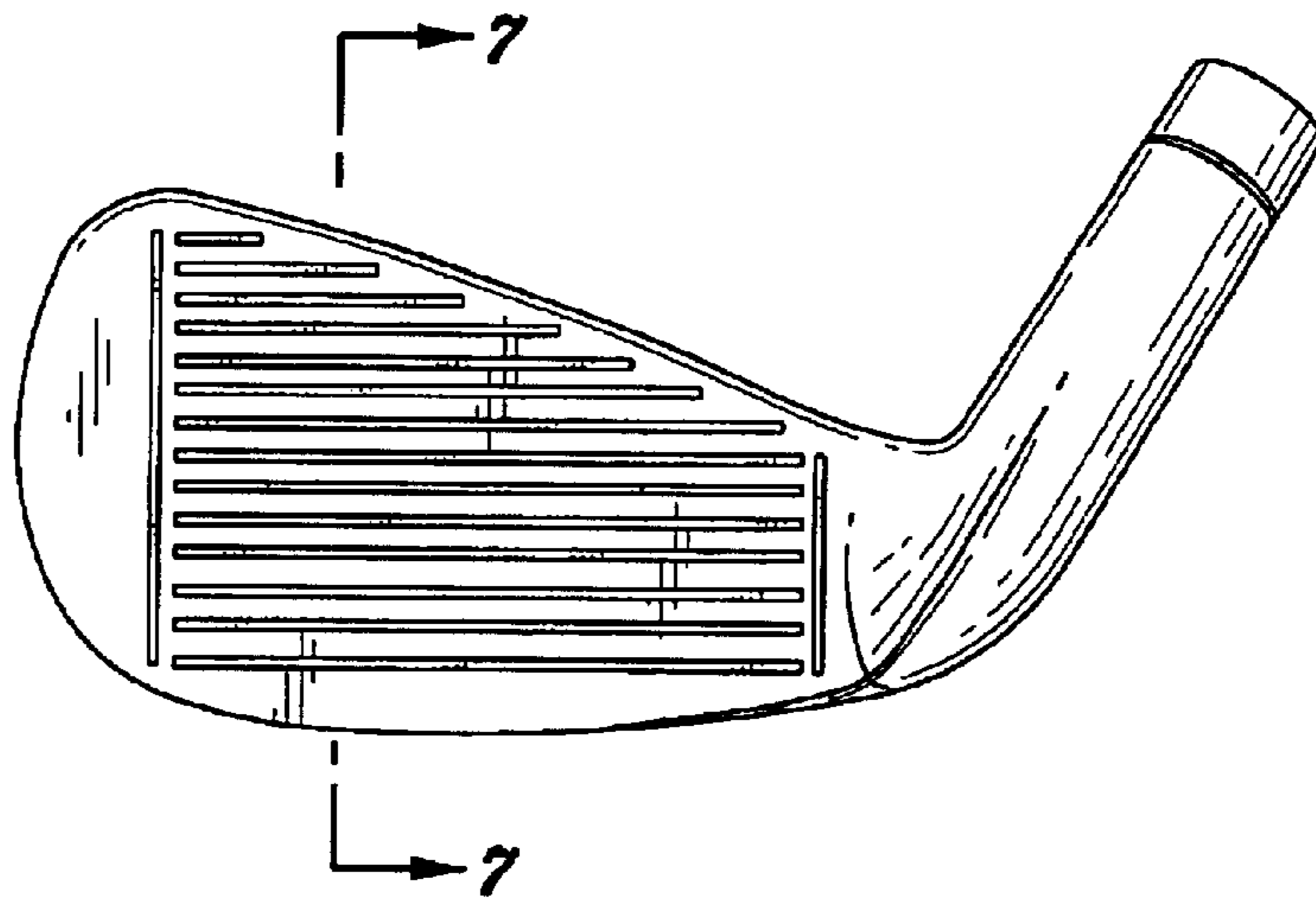

Fig. 4

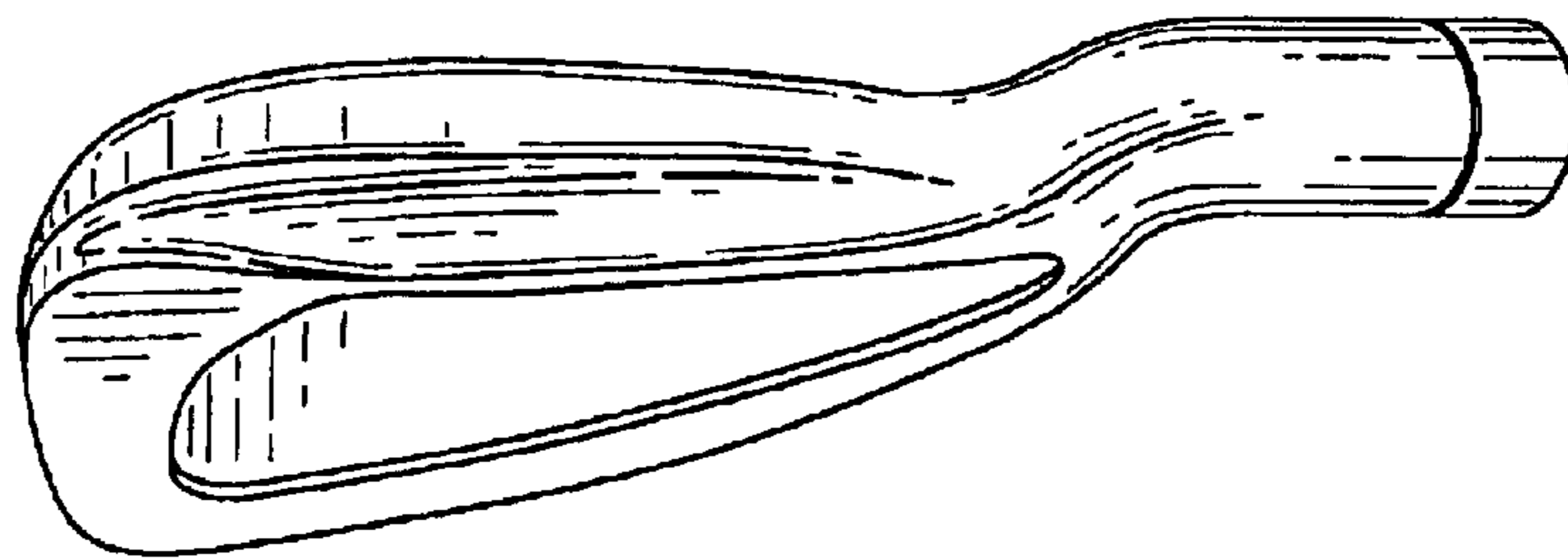

Fig. 5

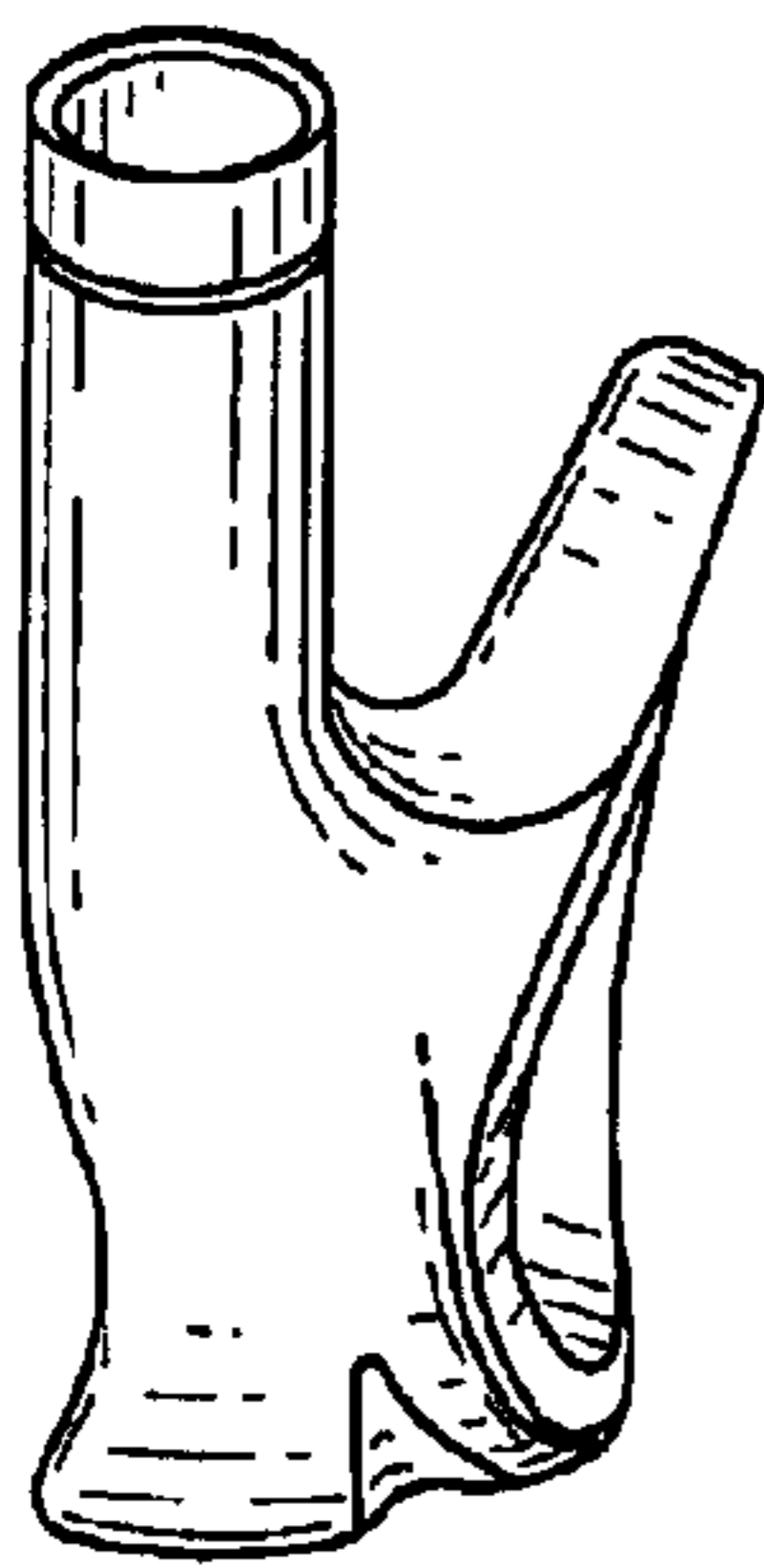

Fig. 6

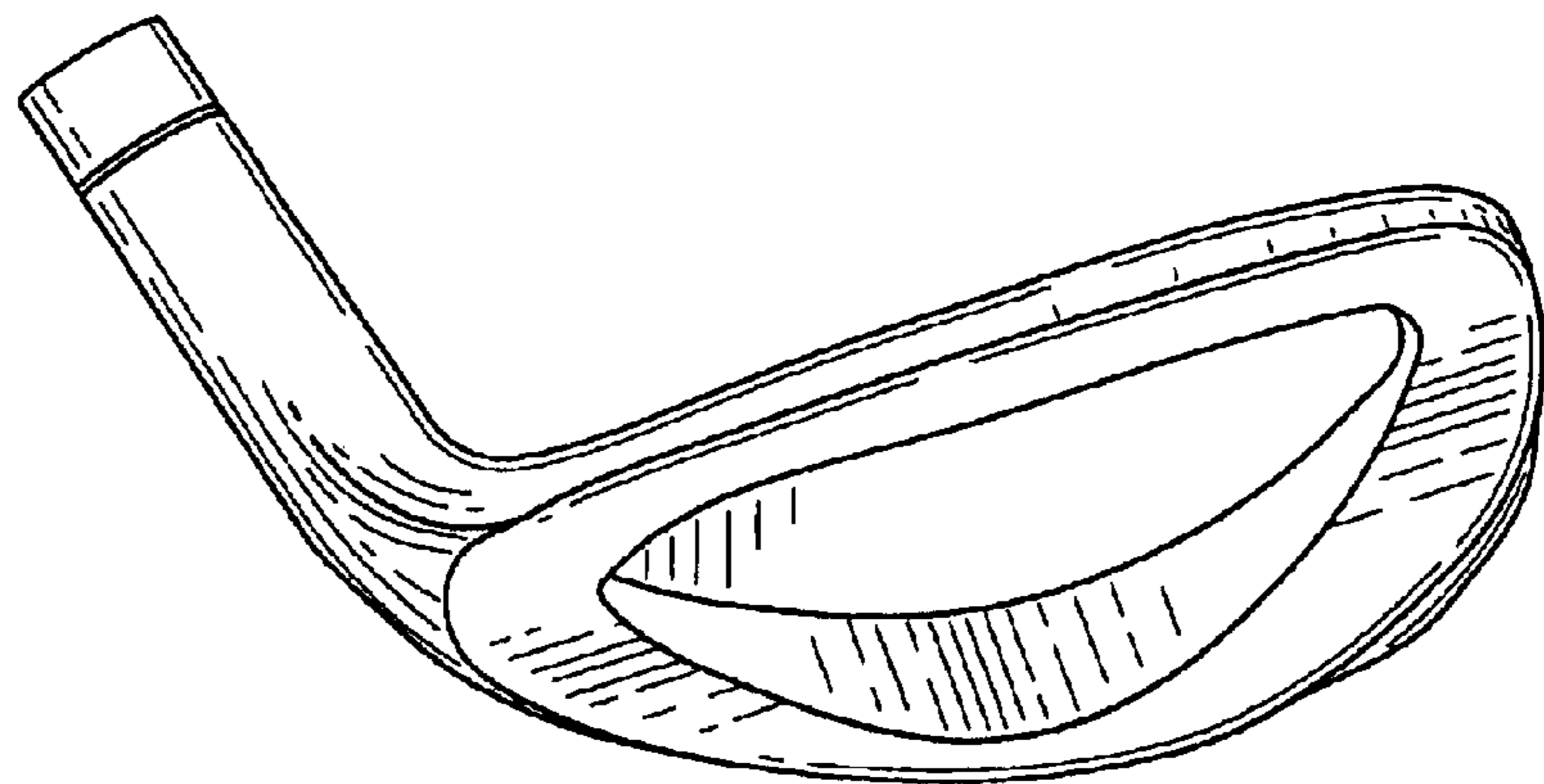

Fig. 7

