

US00D495005S1

(12) **United States Design Patent**
Stravitz

(10) **Patent No.:** **US D495,005 S**

(45) **Date of Patent:** **** Aug. 24, 2004**

(54) **ORGANIZER**

(76) **Inventor:** **David M. Stravitz**, 16 Park Ave. Suite
14A, New York, NY (US) 10016

(**) **Term:** **14 Years**

(21) **Appl. No.:** **29/193,869**

(22) **Filed:** **Nov. 14, 2003**

(51) **LOC (7) Cl. 19-02**

(52) **U.S. Cl. D19/75; D19/90; D19/92;**
D6/567

(58) **Field of Search D19/65, 75, 77,**
D19/78, 86, 90, 91, 92, 95, 99, 100; 211/10,
11, 13.1, 50, 55, 126.5, 126.13; 206/215,
555, 557; D6/553, 567

(56) **References Cited**

U.S. PATENT DOCUMENTS

D59,275 S	*	10/1921	Plym	D19/78 X
1,890,143 A	*	12/1932	Bales	211/126.5
D154,560 S	*	7/1949	McCay et al.	D19/92
D156,758 S	*	1/1950	Niesner	D19/75
4,074,810 A	*	2/1978	Juergens et al.	211/11
D251,254 S	*	3/1979	Tiedemann	D19/90

D270,256 S	*	8/1983	Sankey	D19/77
D331,423 S	*	12/1992	Brüssing	D19/75
D349,904 S	*	8/1994	Arenberg	D19/90 X
D356,337 S	*	3/1995	Douglas	D19/75
D409,242 S	*	5/1999	Stravitz	D19/75

* cited by examiner

Primary Examiner—Martie K. Holtje

(74) *Attorney, Agent, or Firm*—Frishauf, Holtz, Goodman
& Chick, P.C.

(57) **CLAIM**

The ornamental design for an organizer, as shown and described.

DESCRIPTION

FIG. 1 is a front, top, right-side perspective view of an organizer showing my new design;
FIG. 2 is a front elevational view thereof;
FIG. 3 is a top plan view thereof;
FIG. 4 is a rear elevational view thereof;
FIG. 5 is a bottom plan view thereof;
FIG. 6 is a left side view thereof; the right side view being a mirror image; and,
FIG. 7 is rear, top, left side perspective view thereof.

1 Claim, 4 Drawing Sheets

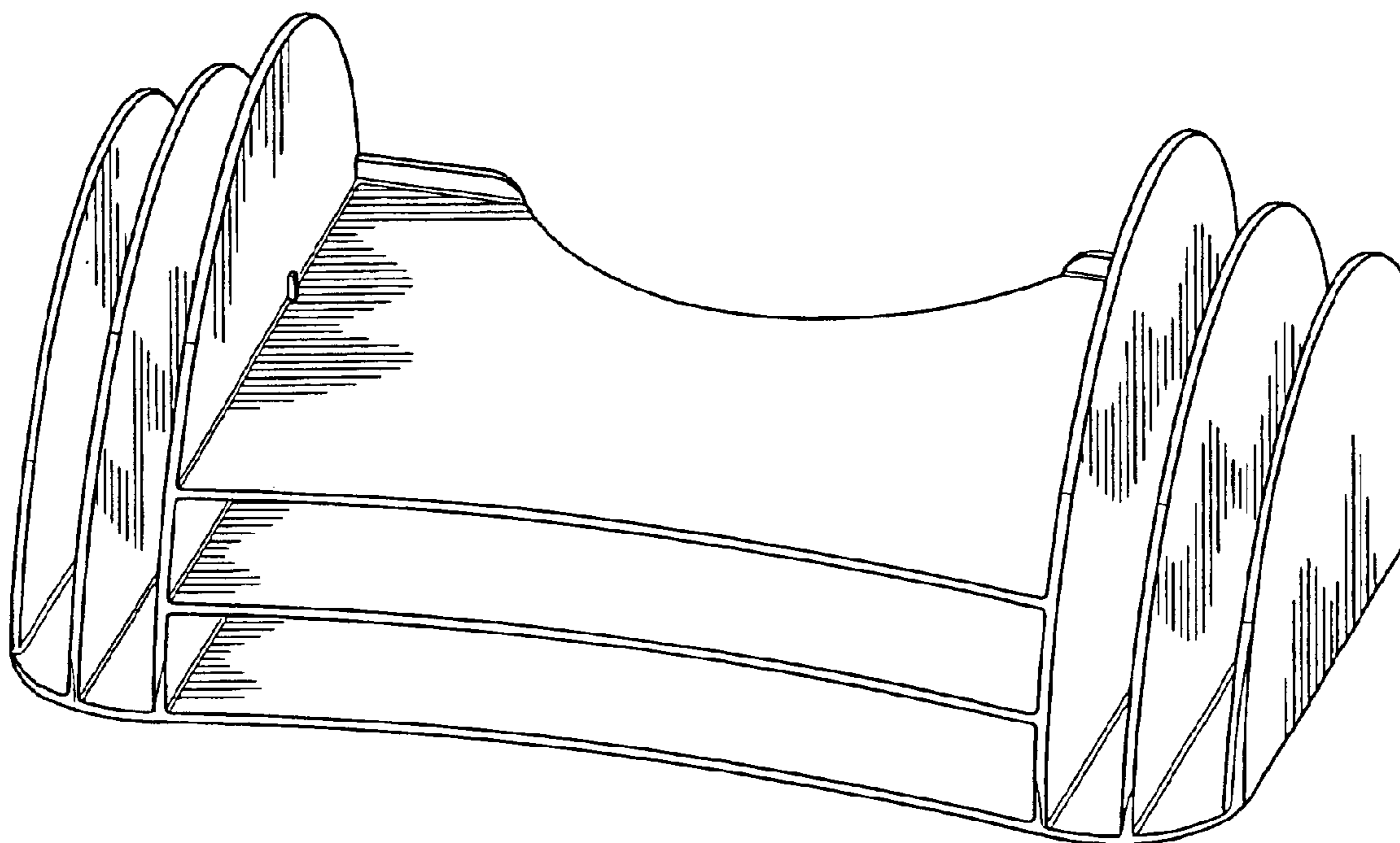

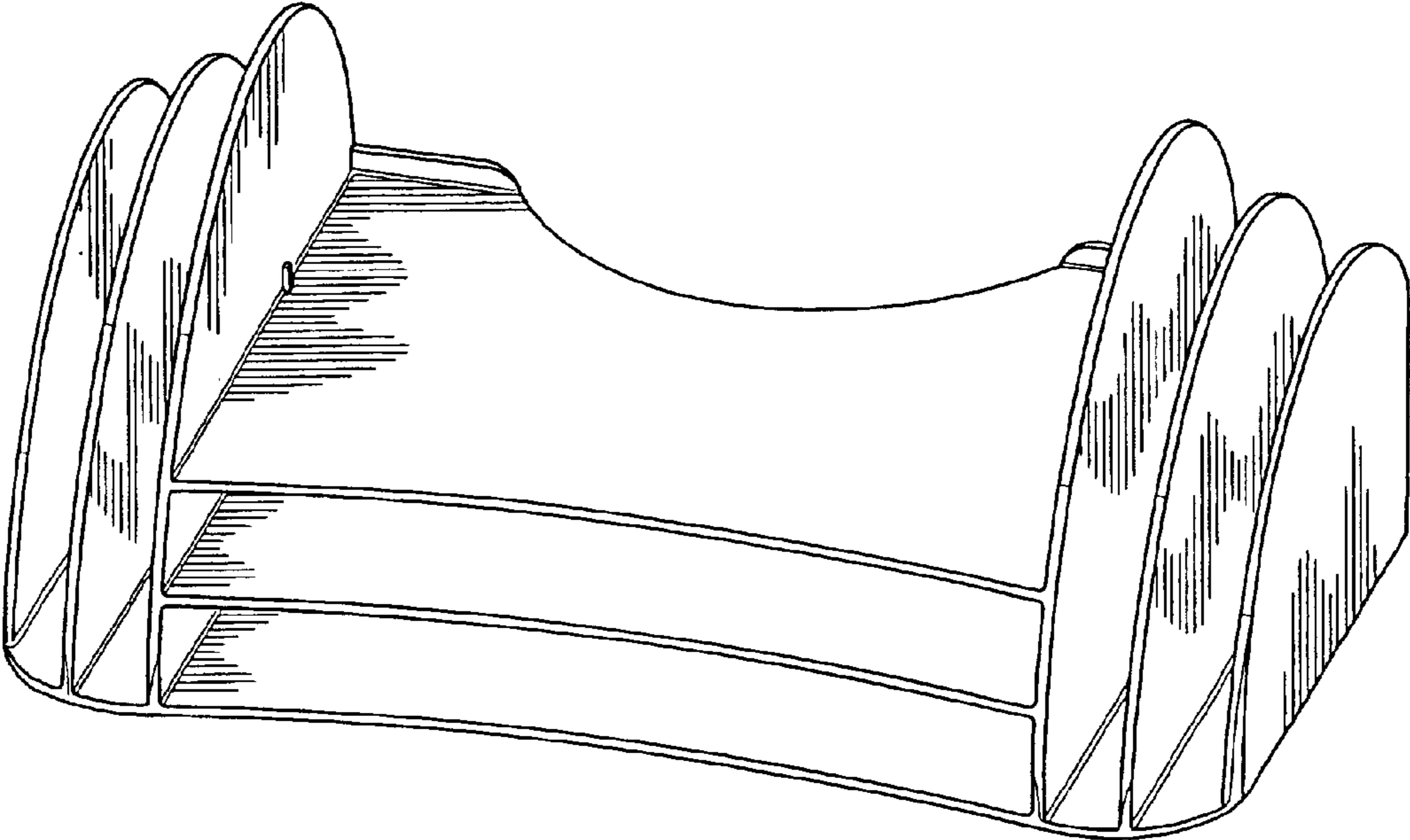

FIG. 1

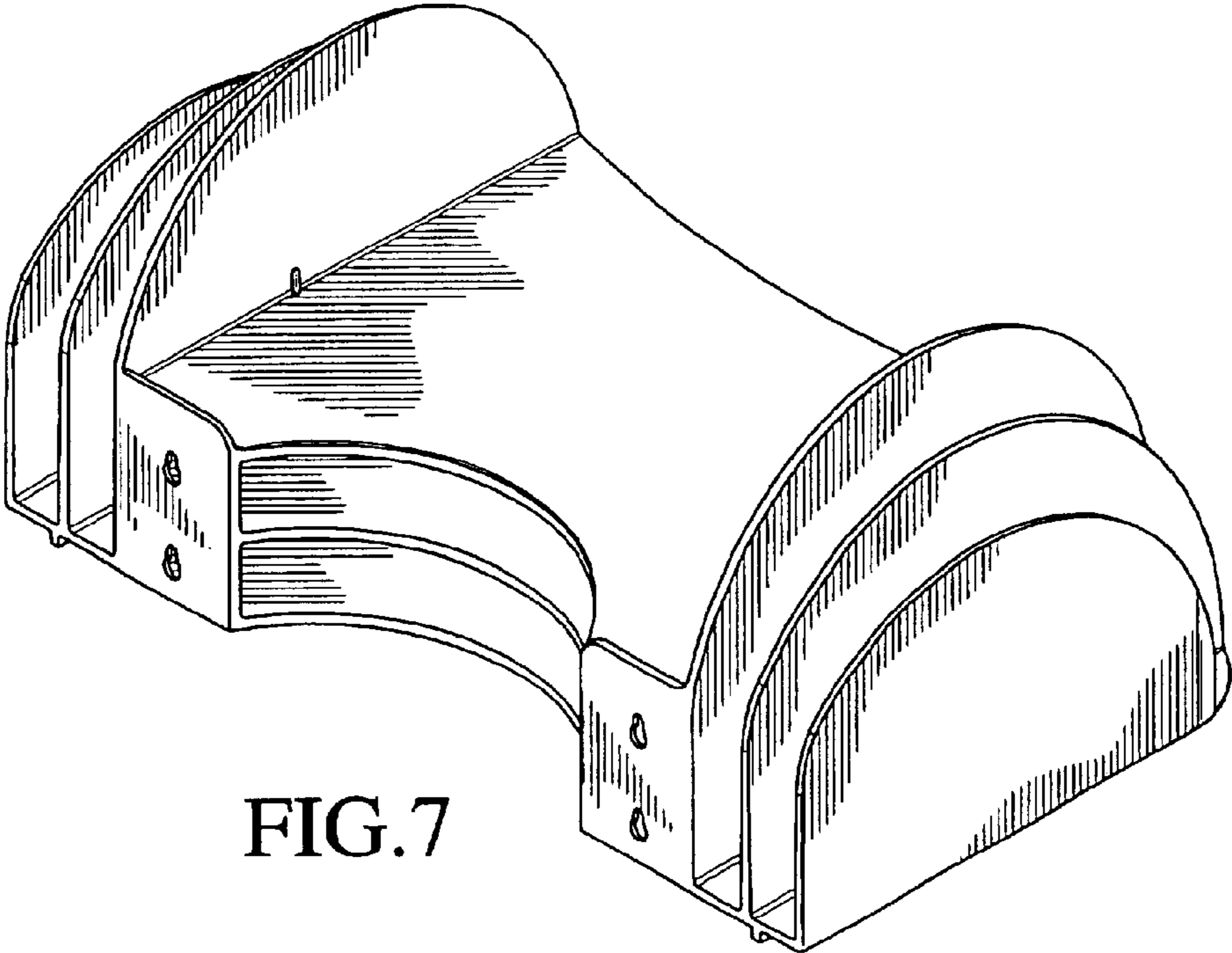

FIG. 7

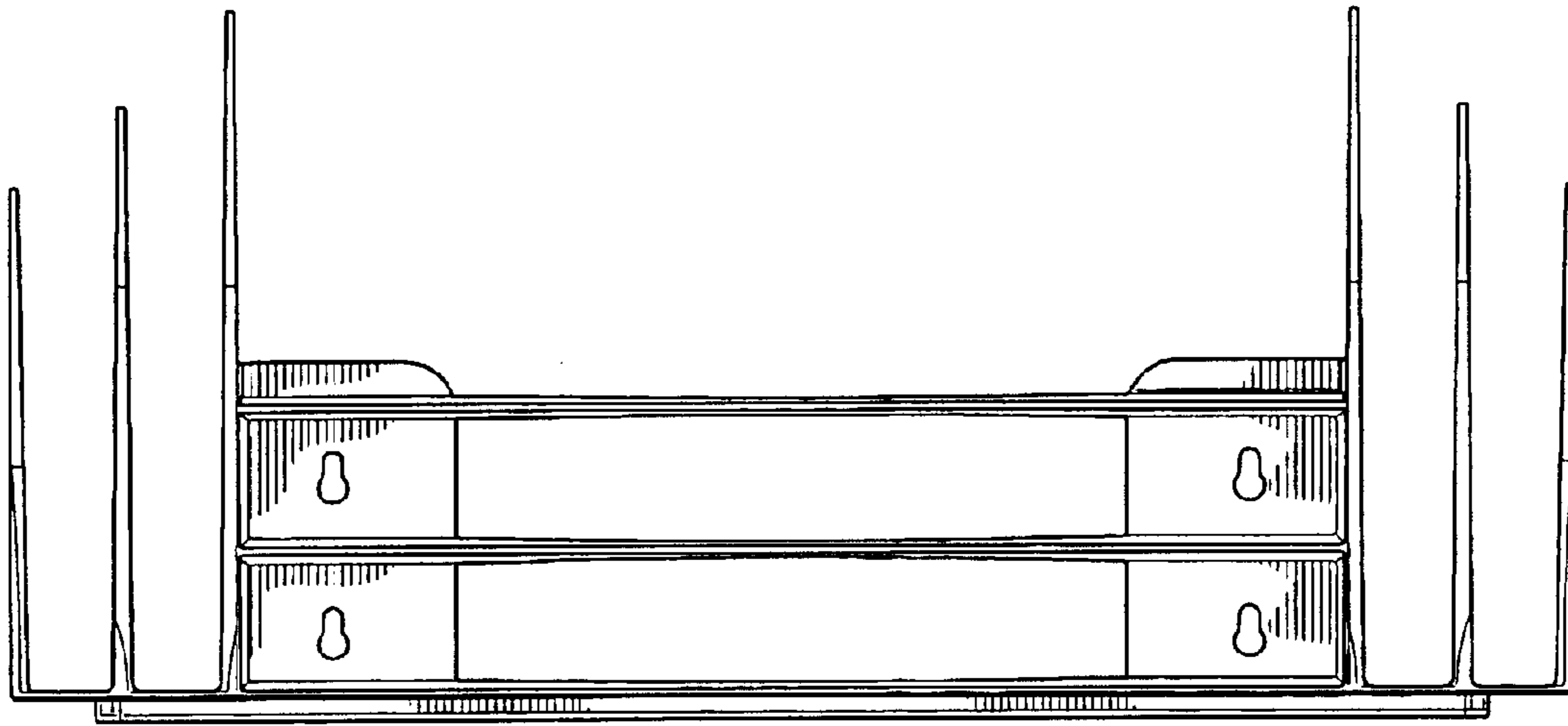

FIG. 2

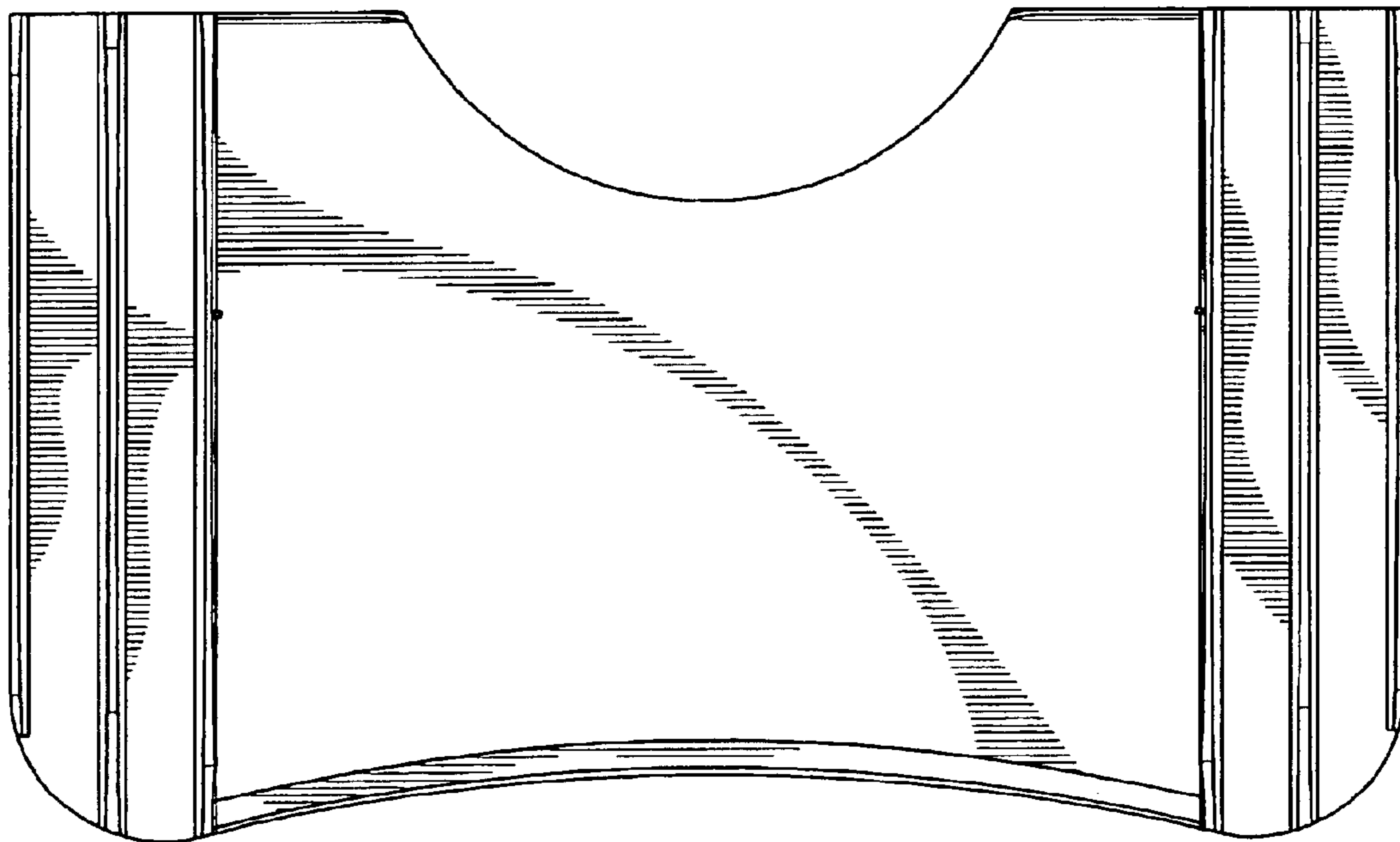

FIG. 3

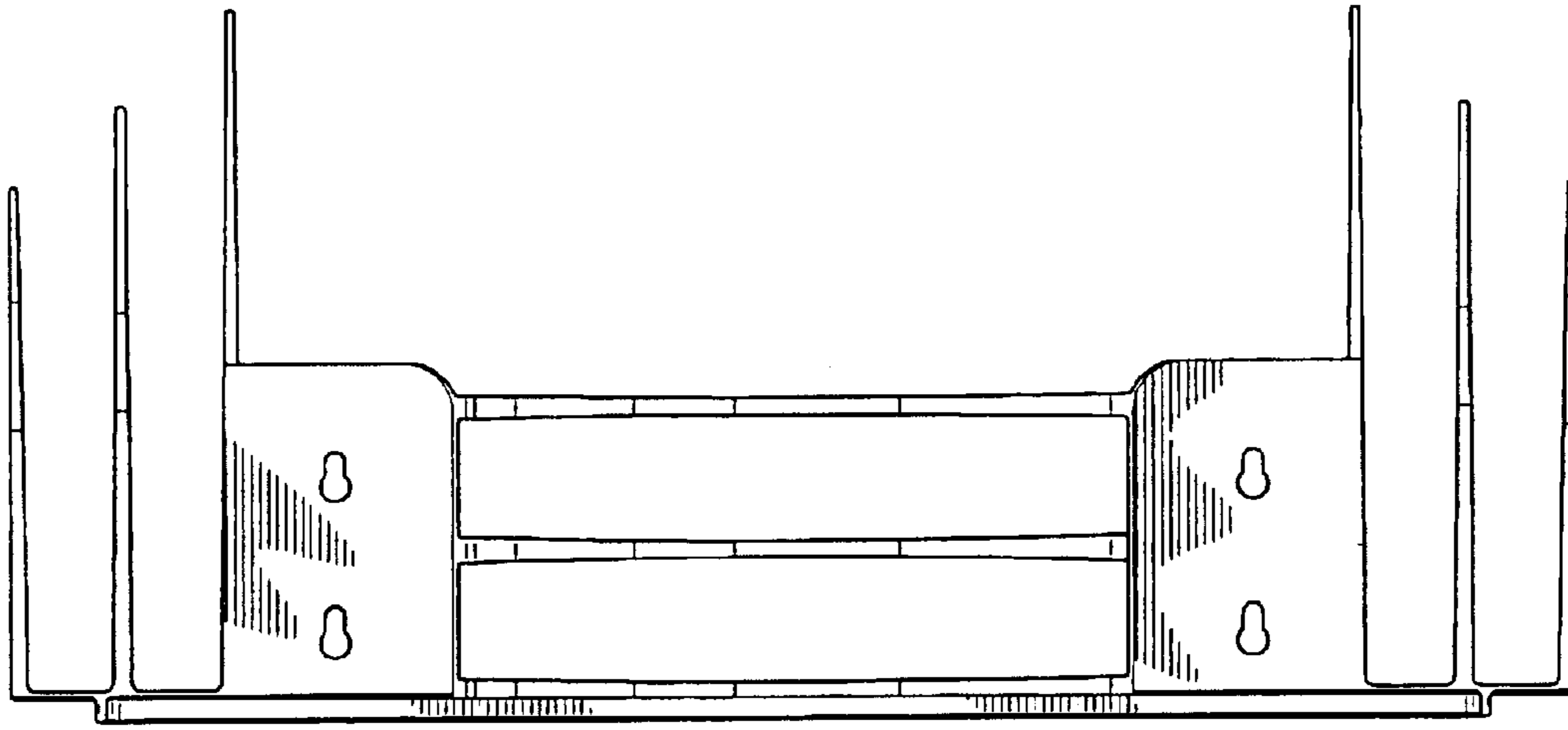

FIG. 4

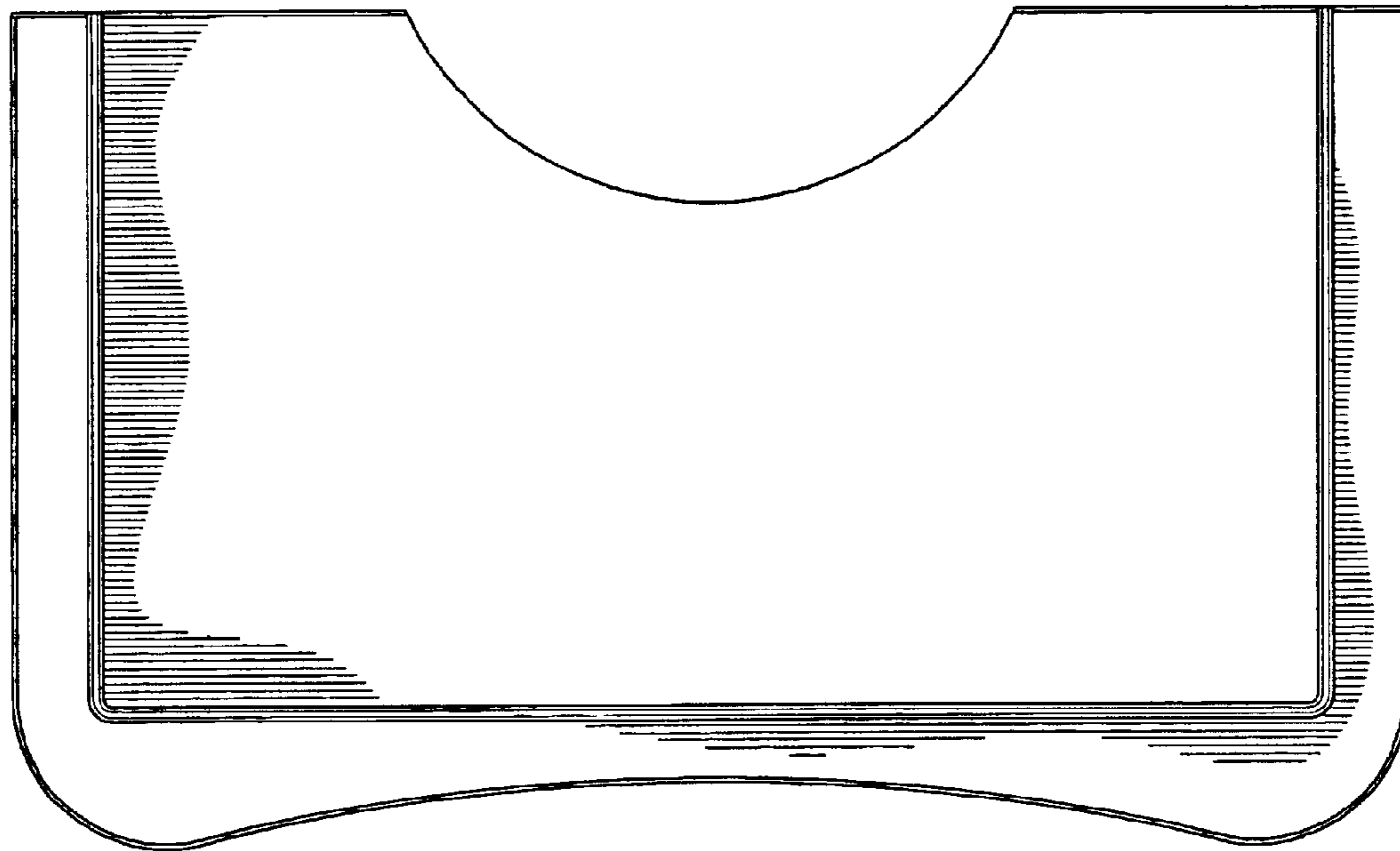

FIG. 5

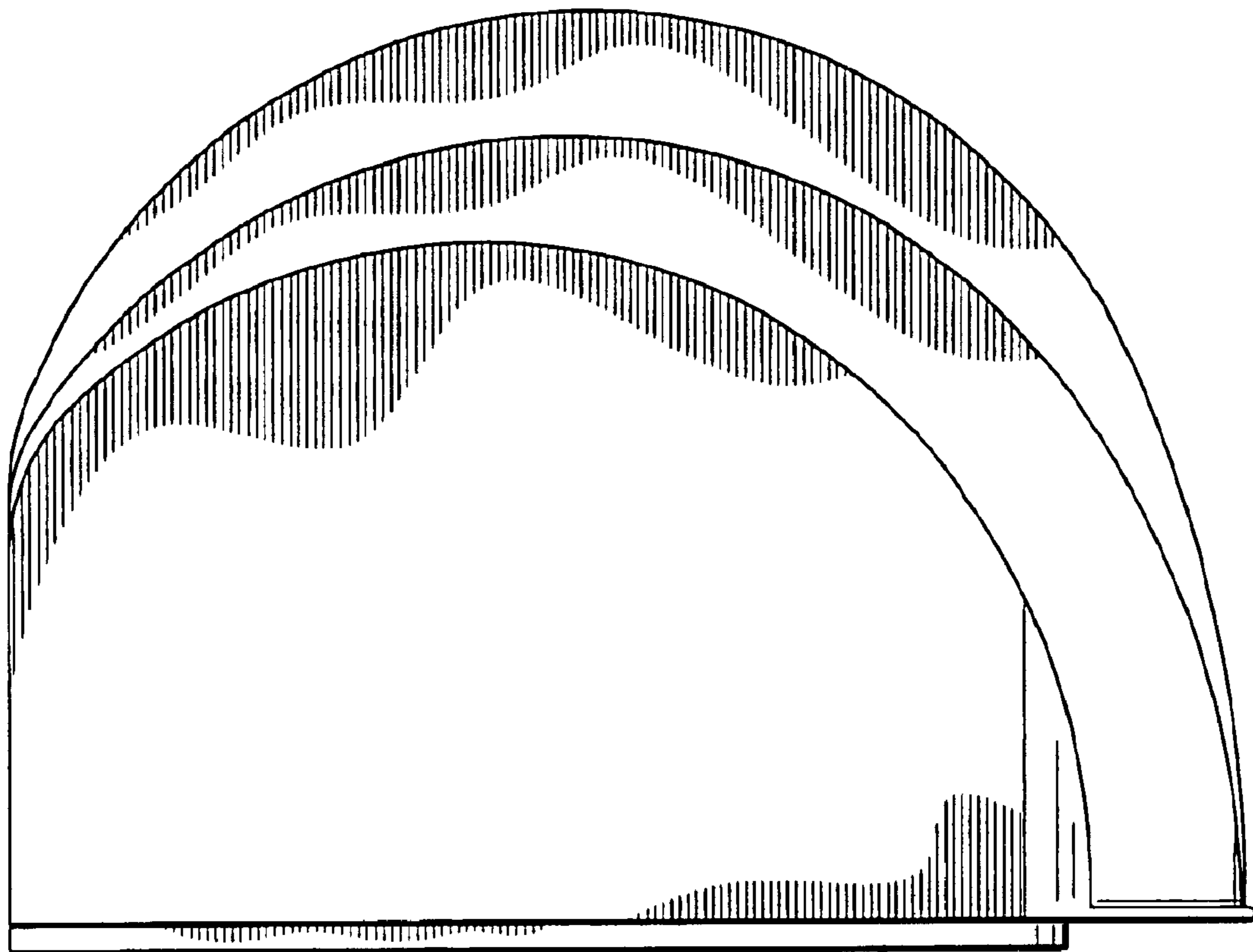

FIG.6