

US00D494997S1

(12) **United States Design Patent**  
**Weiler et al.**

(10) **Patent No.:** **US D494,997 S**  
(45) **Date of Patent:** **\*\* Aug. 24, 2004**

(54) **FORMED RETAINING CLIP FOR A  
REMANUFACTURED TONER CARTRIDGE**

(75) Inventors: **Allan P. Weiler**, Sanford, NC (US);  
**Kristoffer A. Hazen**, Sanford, NC (US)

(73) Assignee: **Static Control Components, Inc.**,  
Sanford, NC (US)

(\*\*) Term: **14 Years**

(21) Appl. No.: **29/185,062**

(22) Filed: **Jun. 19, 2003**

(51) **LOC (7) Cl.** ..... **16-03**

(52) **U.S. Cl.** ..... **D18/40**

(58) **Field of Search** ..... D18/40, 43, 56;  
D7/669; D8/343, 356, 382, 383, 394-396,  
499; 24/1, 16 R, 22, 3.12, 3.1, 136 R, 302,  
306, 289-297, 455, 459, 522, 545, 546,  
570

(56) **References Cited**

**U.S. PATENT DOCUMENTS**

809,049 A	1/1906	Gillett	
1,681,925 A	8/1928	Anderson	
4,605,978 A	8/1986	Zeavin	
4,637,098 A *	1/1987	Okura et al. ....	24/136 R
5,941,434 A	8/1999	Green	
6,079,084 A	6/2000	Gwynn	
6,240,605 B1	6/2001	Stevens et al.	
D446,807 S *	8/2001	Ozawa et al. ....	D18/40
D468,359 S	1/2003	Chen	
D471,067 S *	3/2003	Coburn et al. ....	D7/669
D473,127 S	4/2003	Yoko	
D473,896 S	4/2003	Yan	
D474,762 S	5/2003	Moberg et al.	

\* cited by examiner

*Primary Examiner*—Caron D. Veynar

(74) *Attorney, Agent, or Firm*—William L. London; Bryan  
A. Shang

(57) **CLAIM**

The ornamental design for a formed retaining clip for a remanufactured toner cartridge, as shown and described.

**DESCRIPTION**

FIG. 1. is a front perspective view of a formed retaining clip for a remanufactured toner cartridge showing our new design;

FIG. 2. is a left side elevation view, the right side being a mirror image thereof;

FIG. 3. is a top plan view thereof;

FIG. 4. is a bottom plan view thereof;

FIG. 5. is a front elevation view thereof;

FIG. 6. is a rear elevation view thereof;

FIG. 7. is a front perspective view of an alternate embodiment of the design shown in FIG. 1;

FIG. 8. is a left side elevation view of FIG. 7, the right side being a mirror image thereof;

FIG. 9. is a top plan view of FIG. 7;

FIG. 10. is a bottom plan view of FIG. 7;

FIG. 11. is a front elevation view of FIG. 7;

FIG. 12. is a rear elevation view of FIG. 7;

FIG. 13. is a front perspective view of a third embodiment of the design shown in FIG. 1;

FIG. 14. is a left side elevation view of FIG. 13, the right side being a mirror image thereof;

FIG. 15. is a top plan view of FIG. 13;

FIG. 16. is a bottom plan view of FIG. 13;

FIG. 17. is a front elevation view of FIG. 13;

FIG. 18. is a rear elevation view of FIG. 13;

FIG. 19. is a front perspective view of a fourth embodiment of the design shown in FIG. 1;

FIG. 20. is a left side elevation view of FIG. 19, the right side being a mirror image thereof;

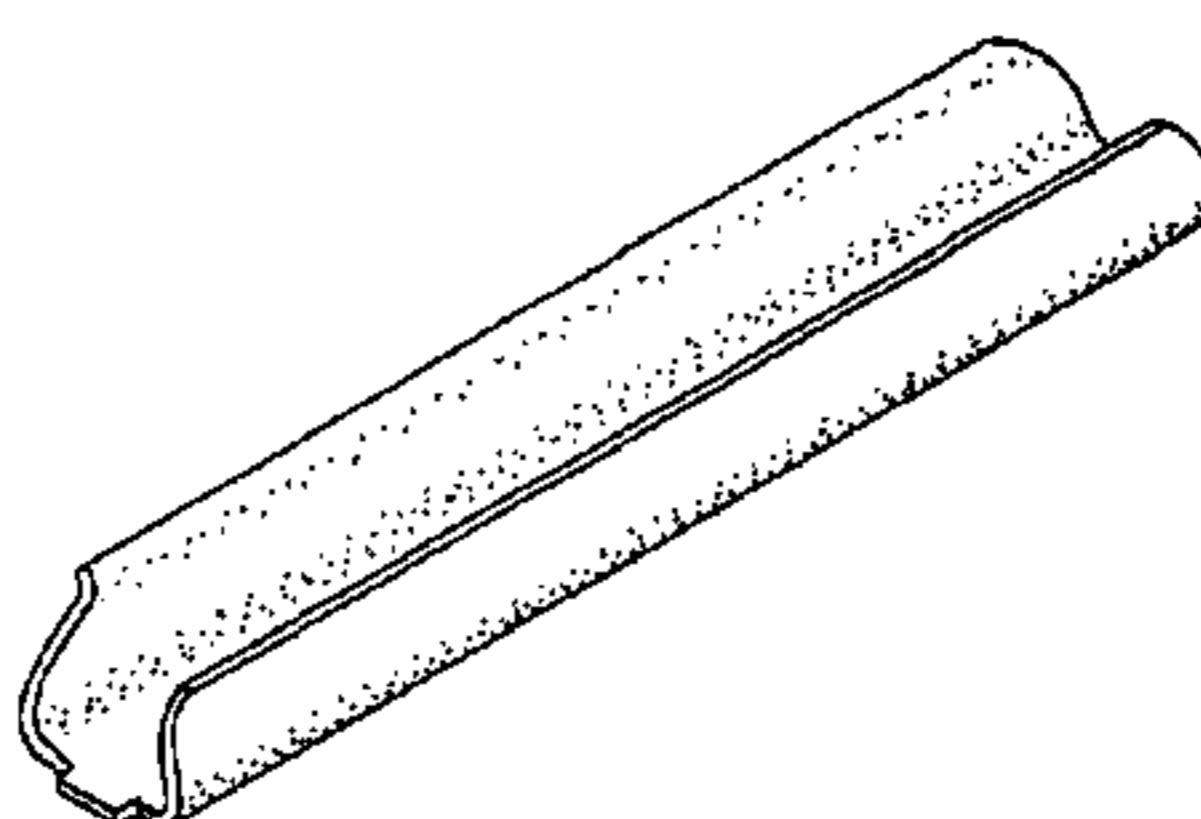
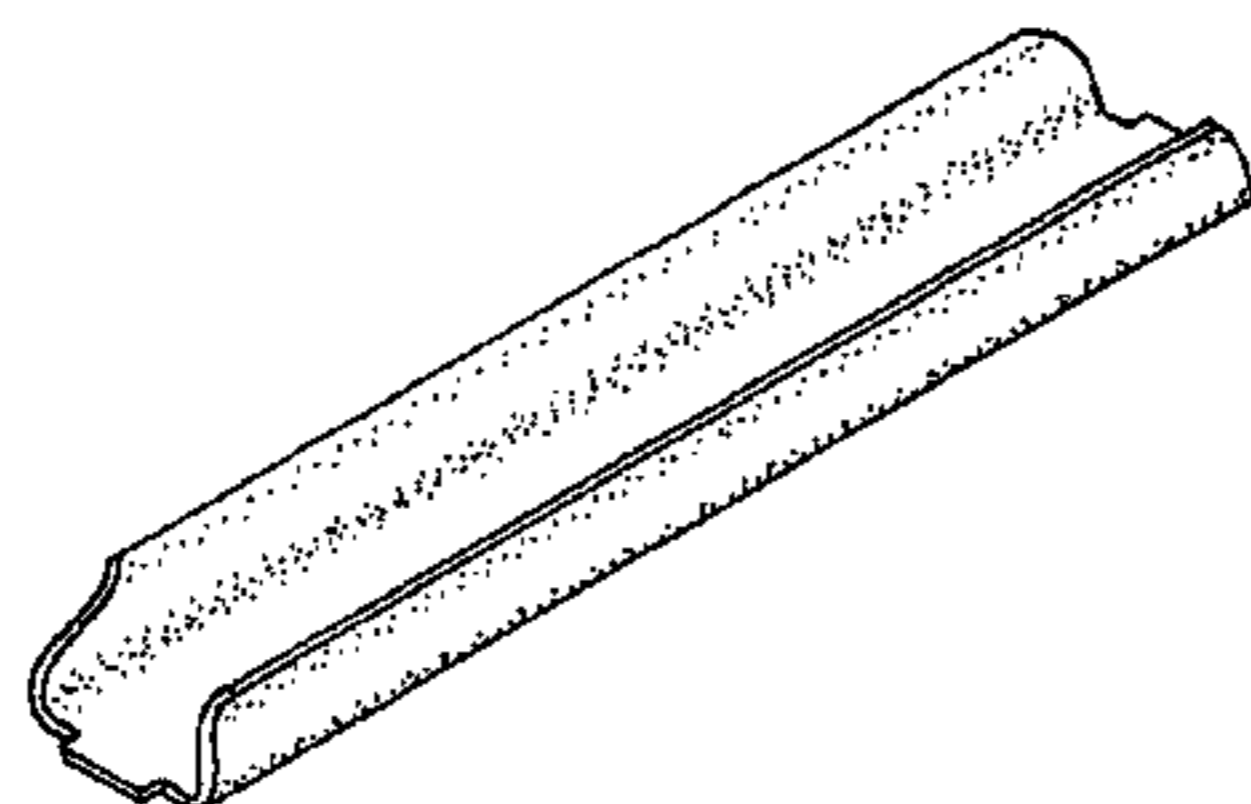
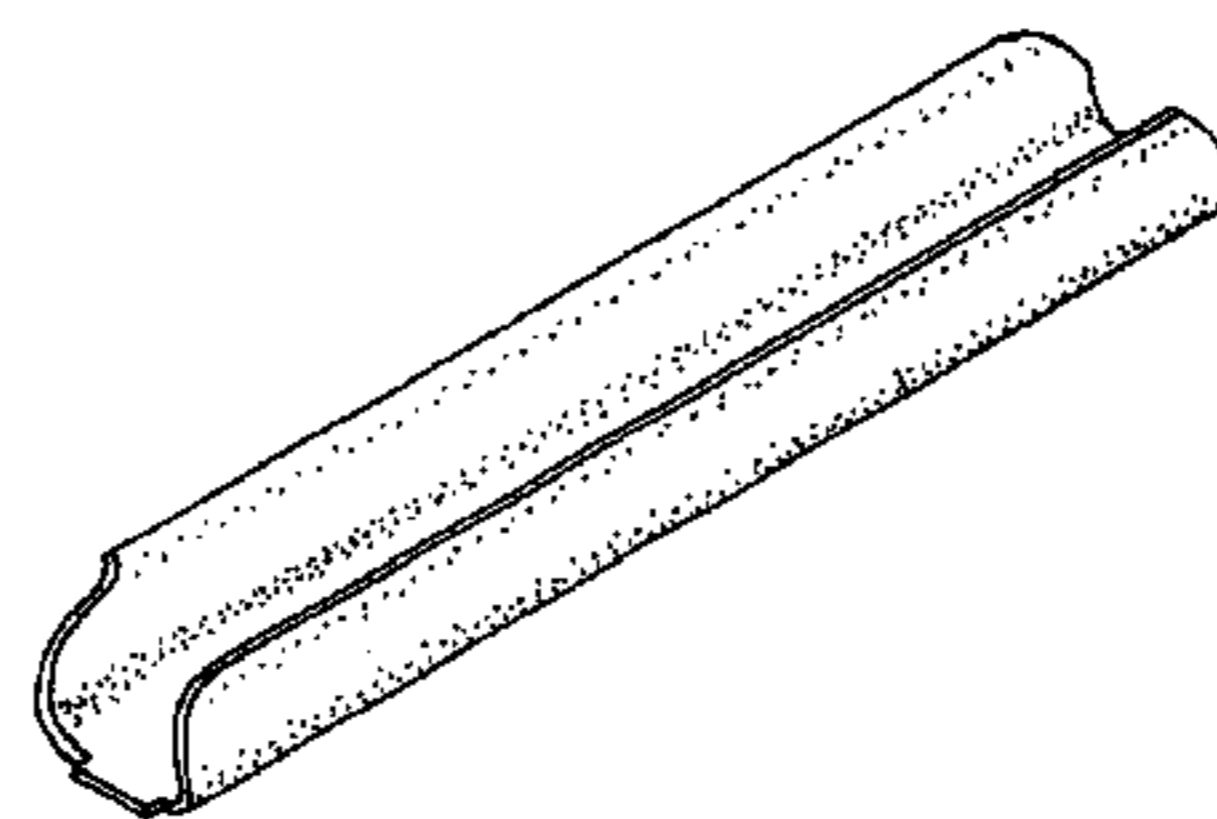
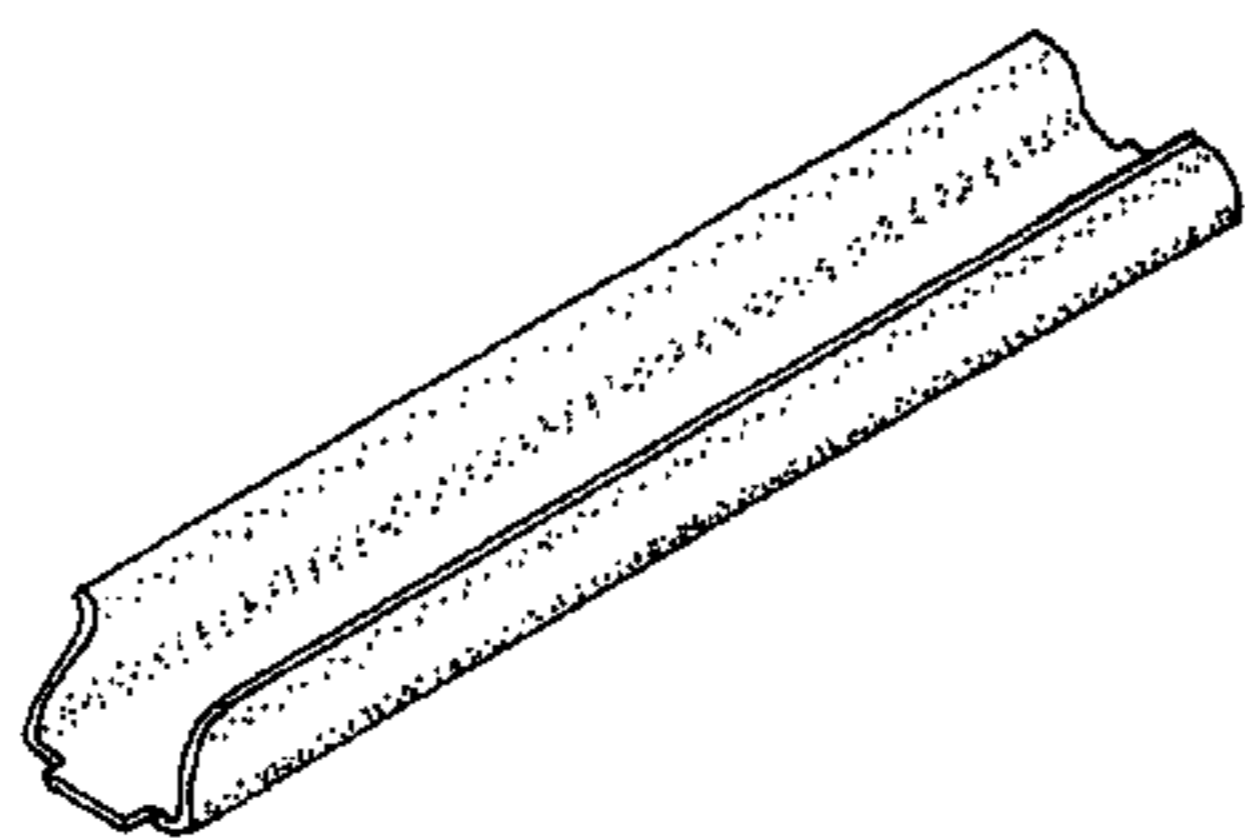
FIG. 21. is a top plan view of FIG. 19;

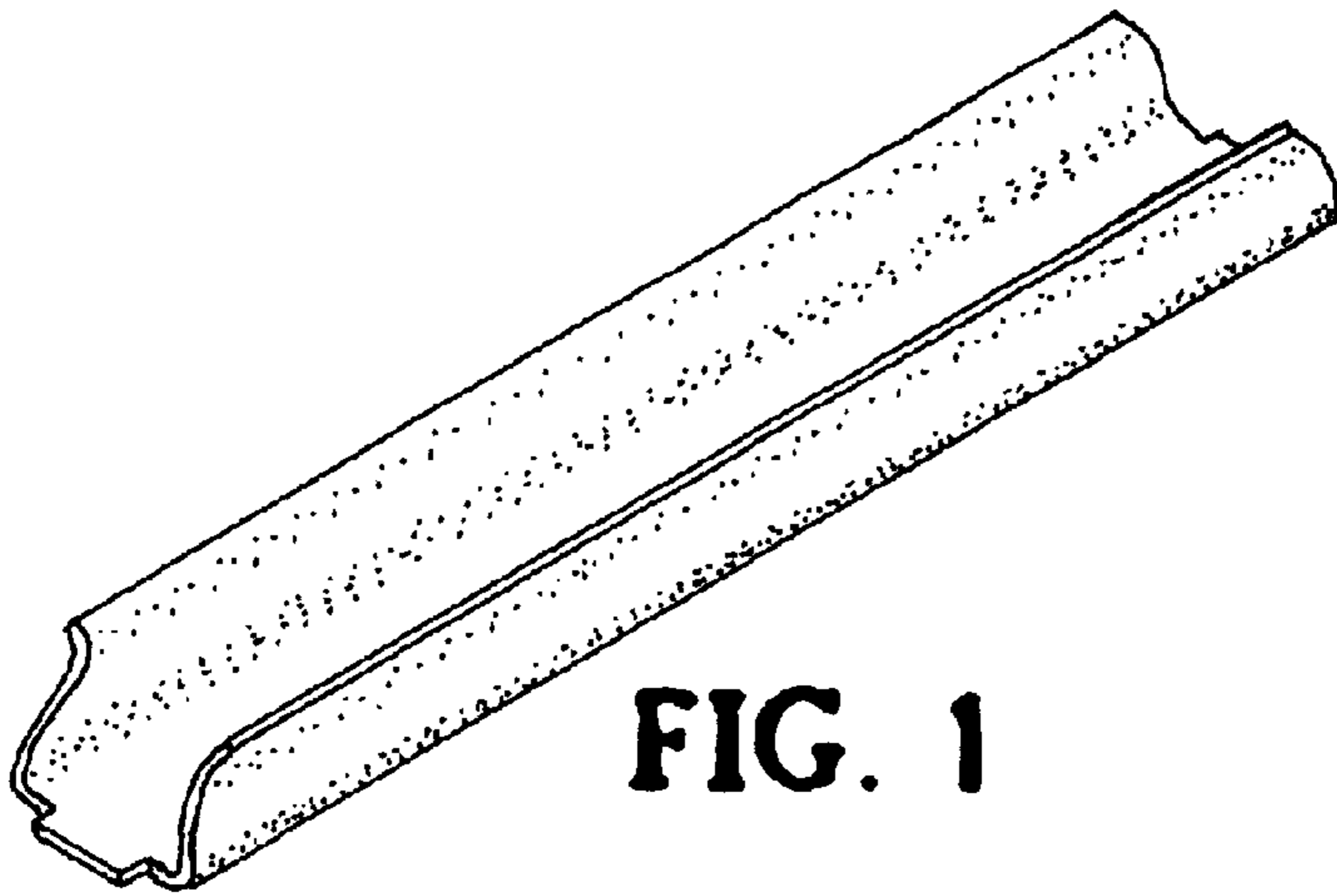
FIG. 22. is a bottom plan view of FIG. 19;

FIG. 23. is a front elevation view of FIG. 19; and,

FIG. 24. is a rear elevation view of FIG. 19.

**1 Claim, 4 Drawing Sheets**

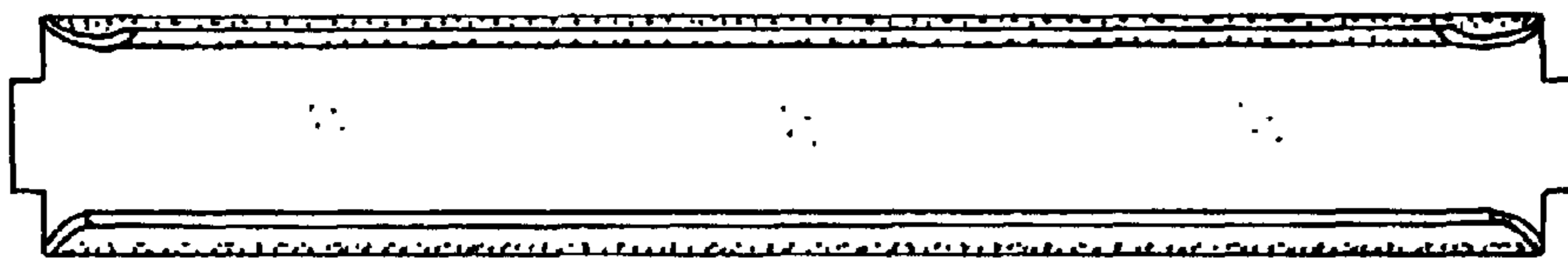




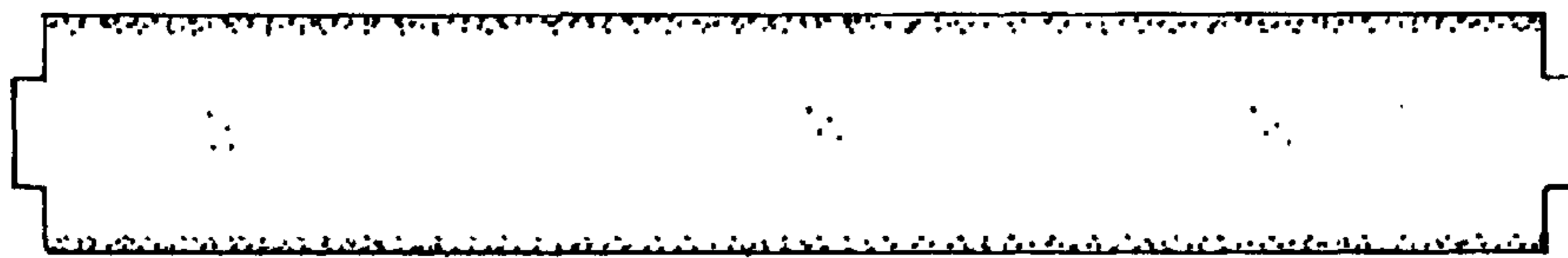
**FIG. 1**



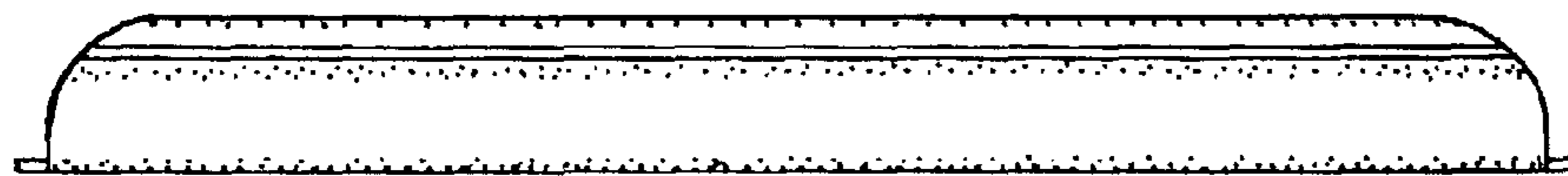
**FIG. 2**



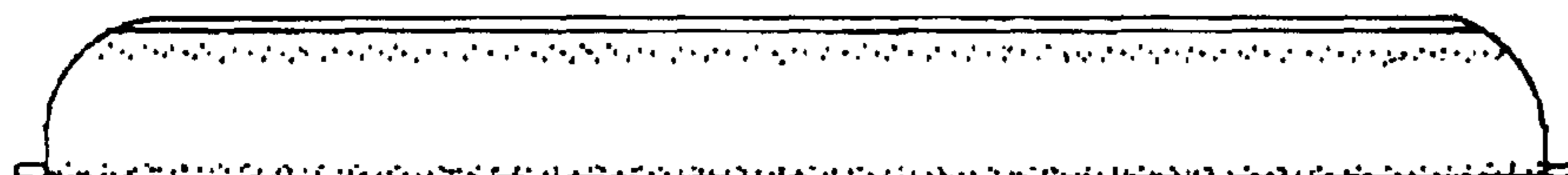
**FIG. 3**



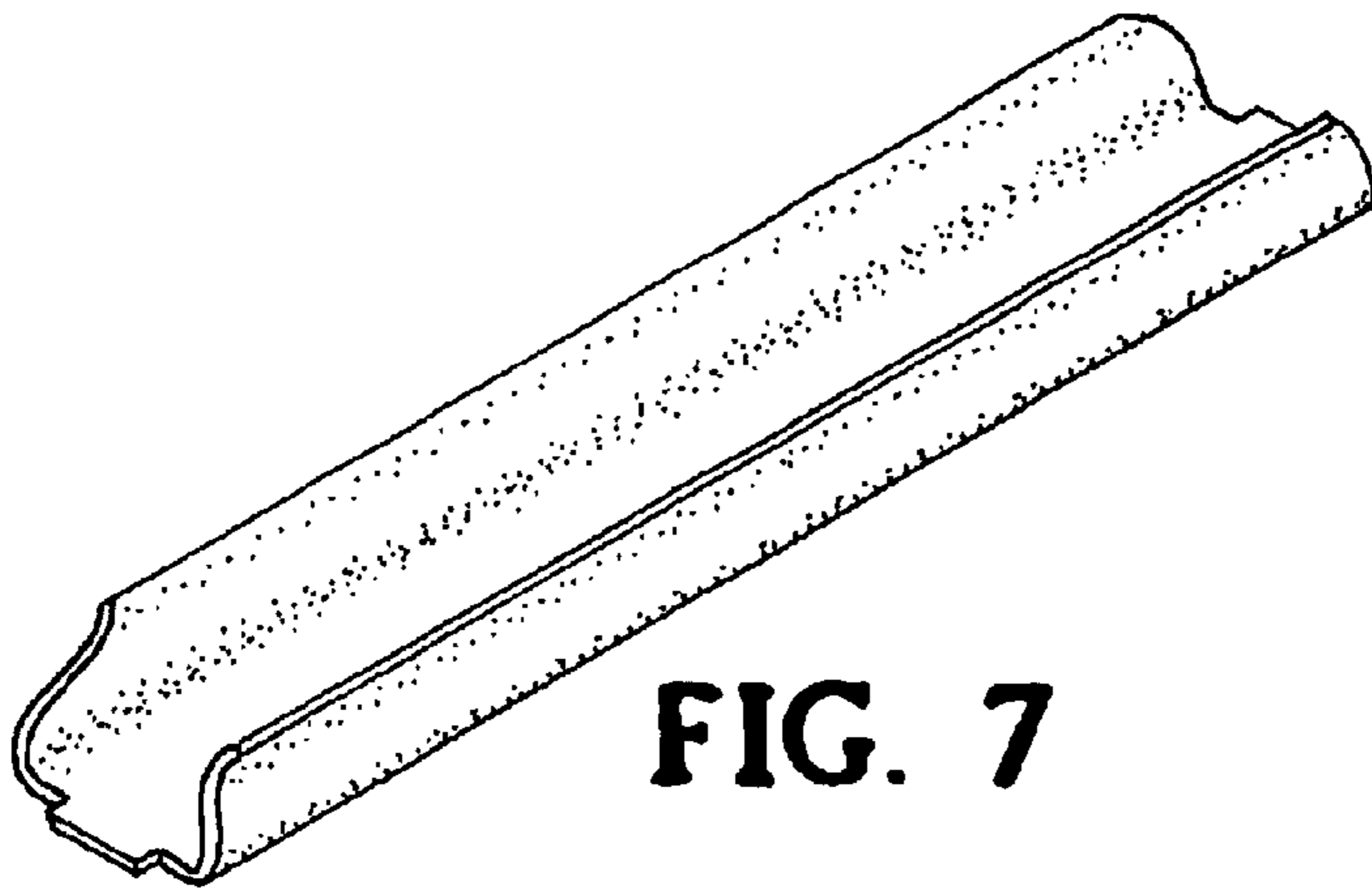
**FIG. 4**



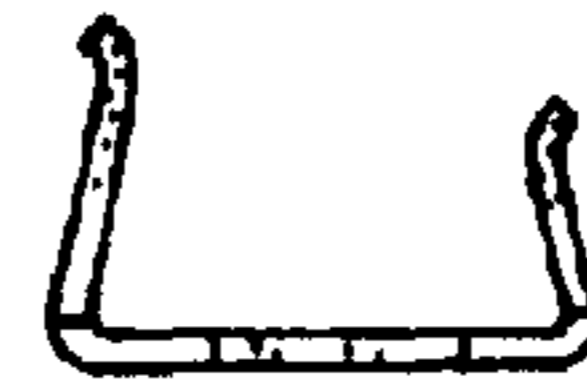
**FIG. 5**



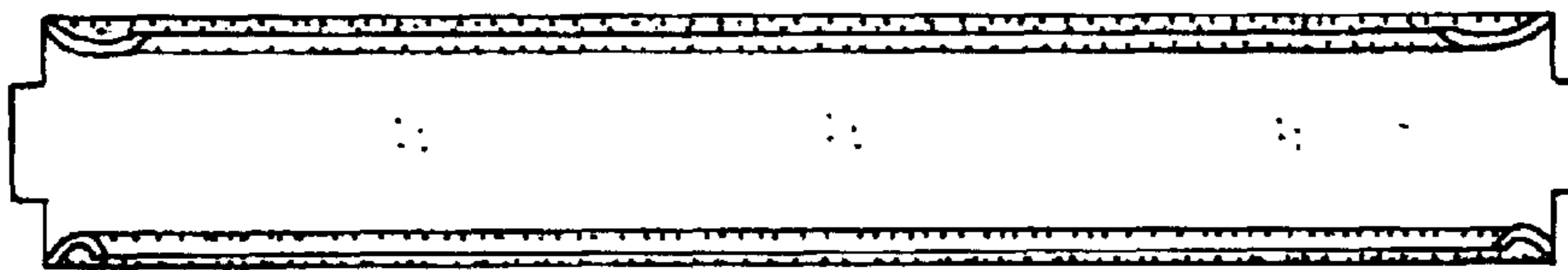
**FIG. 6**



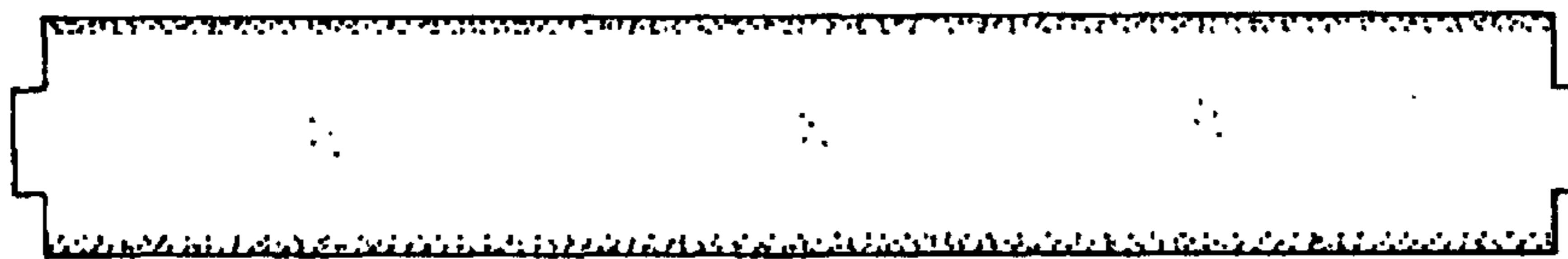
**FIG. 7**



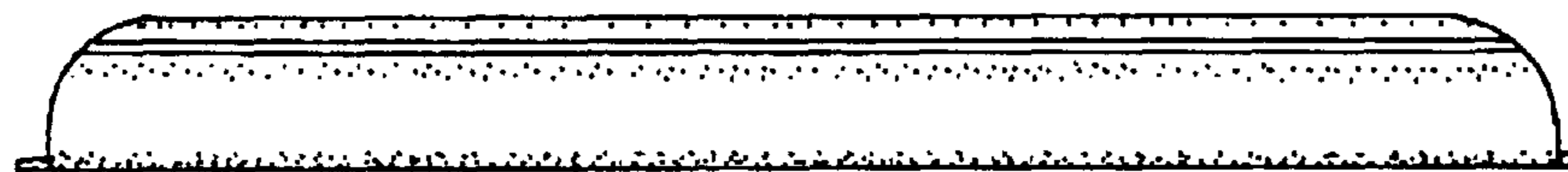
**FIG. 8**



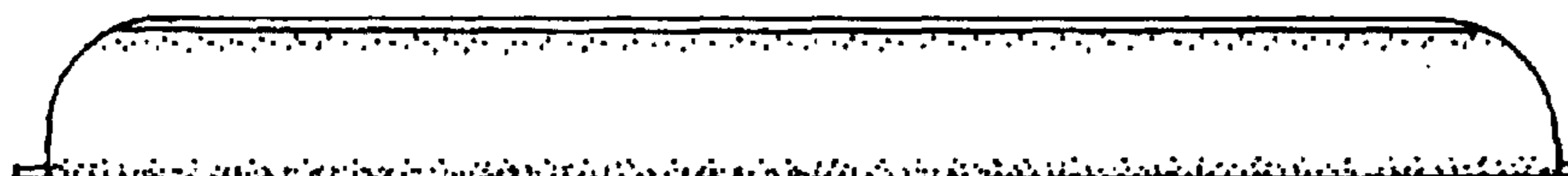
**FIG. 9**



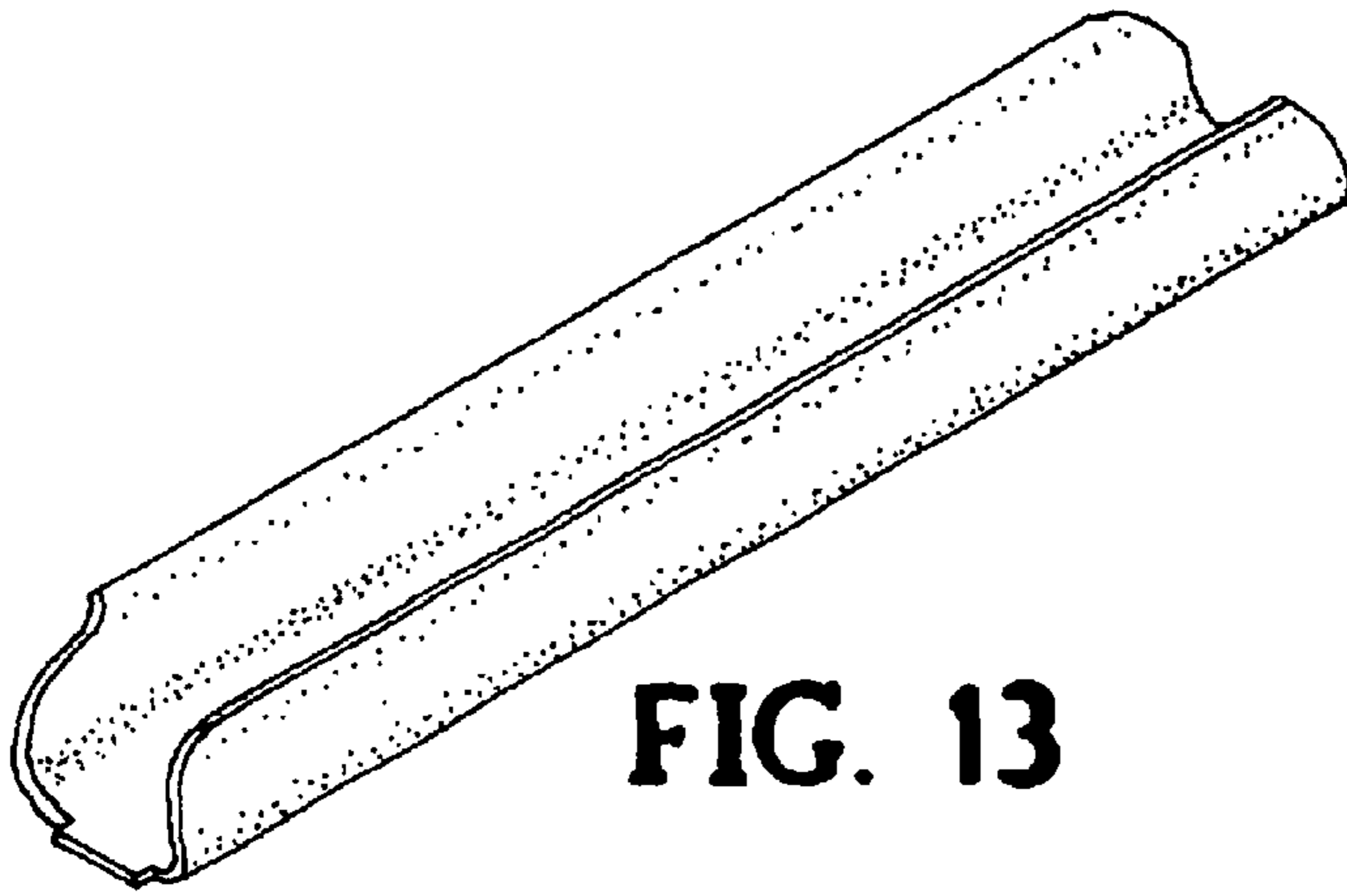
**FIG. 10**



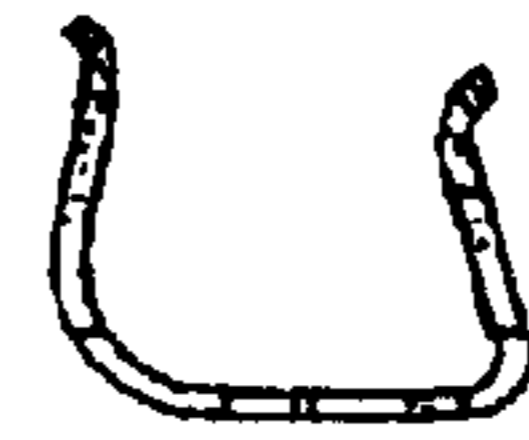
**FIG. 11**



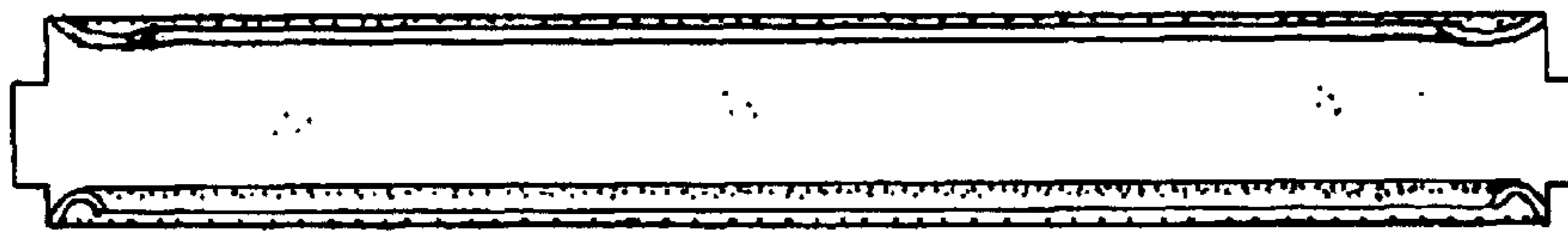
**FIG. 12**



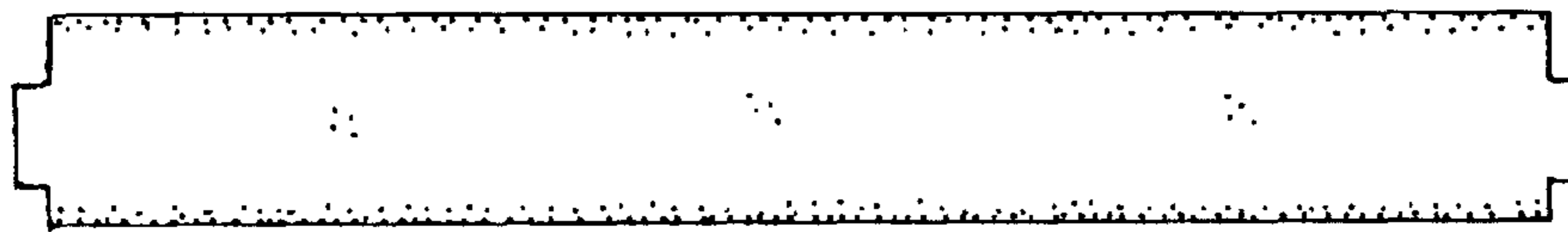
**FIG. 13**



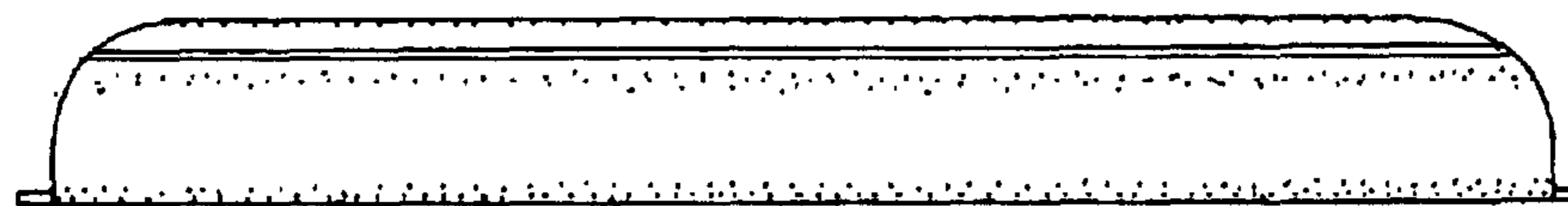
**FIG. 14**



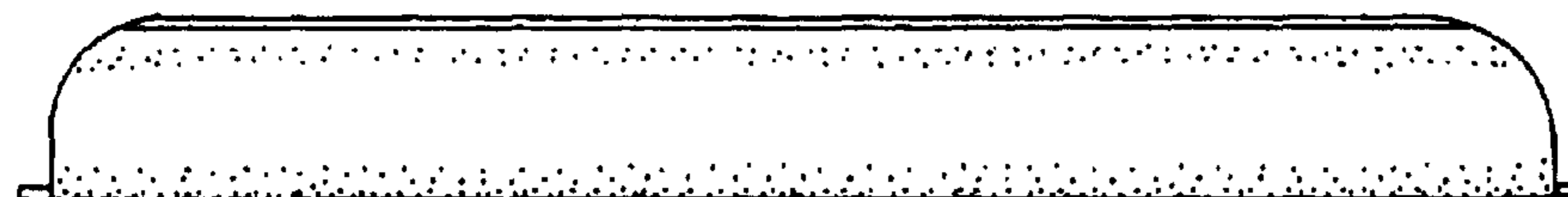
**FIG. 15**



**FIG. 16**

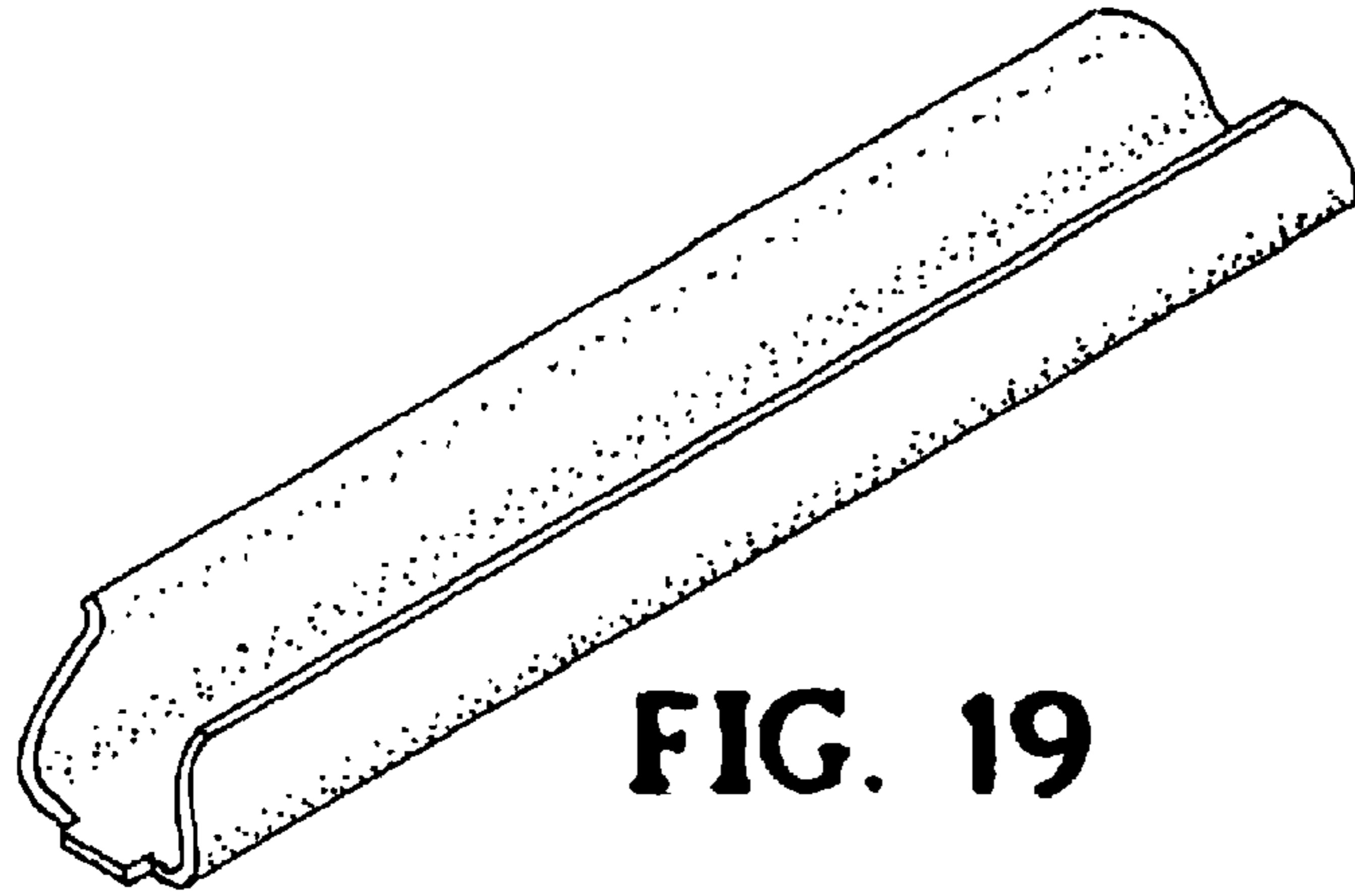


**FIG. 17**

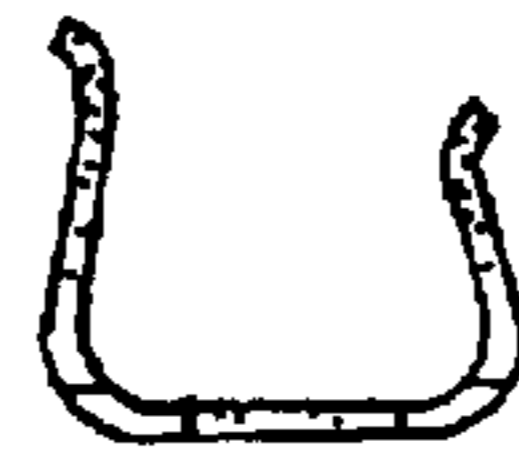


**FIG. 18**

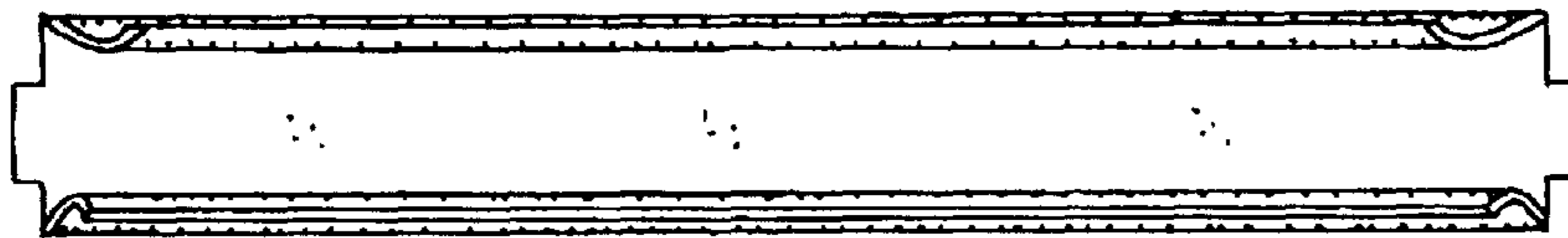




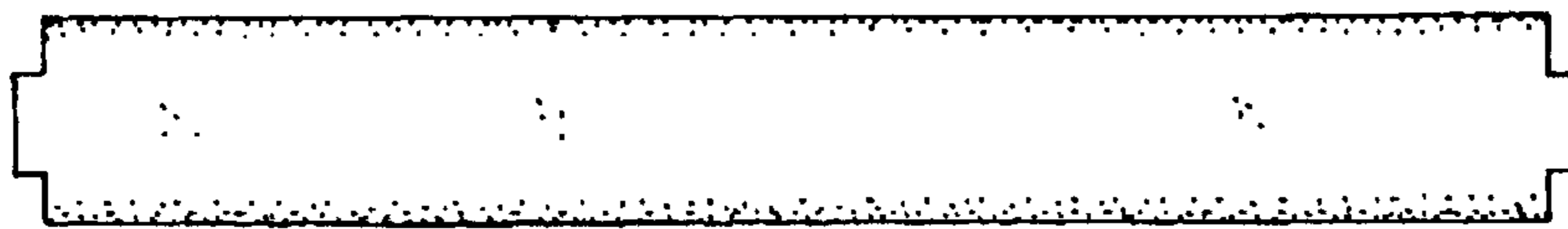
**FIG. 19**



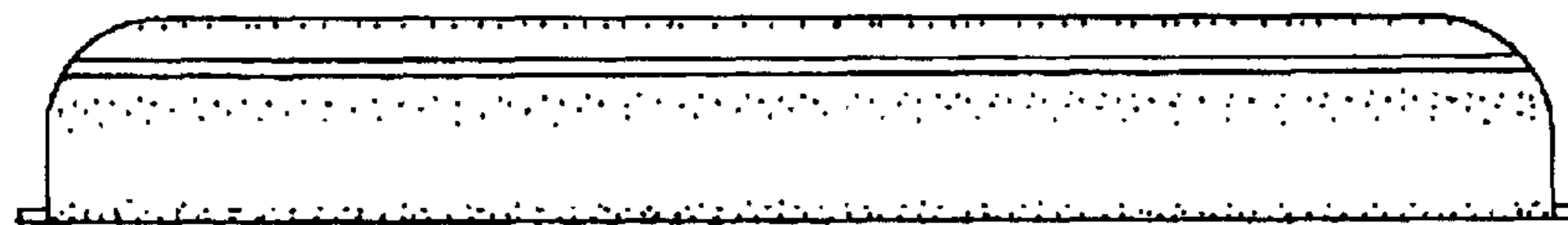
**FIG. 20**



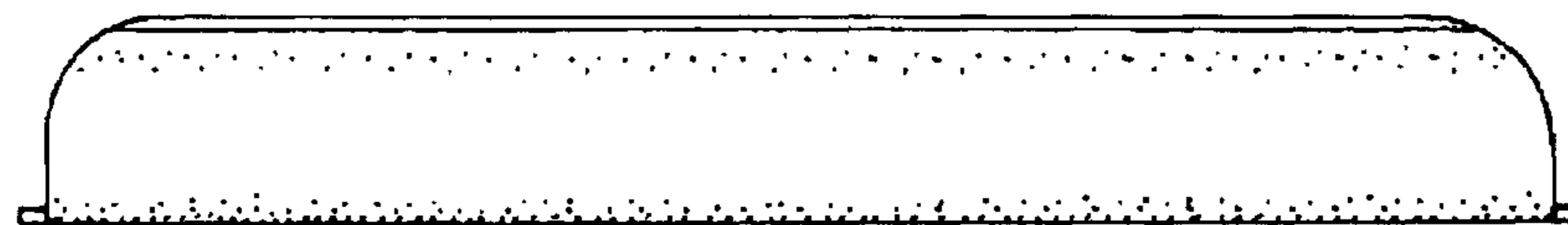
**FIG. 21**



**FIG. 22**



**FIG. 23**



**FIG. 24**