

US00D494836S1

(12) **United States Design Patent**
Bertani

(10) **Patent No.:** **US D494,836 S**

(45) **Date of Patent:** **** Aug. 24, 2004**

(54) **RECESSED HANDLE WITH LID**

(75) **Inventor:** **Alberto Bertani, Milan (IT)**

(73) **Assignee:** **Elesa, S.p.A., Milan (IT)**

(**) **Term:** **14 Years**

(21) **Appl. No.:** **29/175,471**

(22) **Filed:** **Feb. 5, 2003**

(51) **LOC (7) Cl. 08-06**

(52) **U.S. Cl. D8/313**

(58) **Field of Search D8/300, 313, 314;**
16/110.1, 412, 415, 416; 312/244, 348.6

(56) **References Cited**

U.S. PATENT DOCUMENTS

D297,808 S	*	9/1988	King	D8/313
D349,838 S	*	8/1994	Barton et al.	D8/313
5,927,836 A	*	7/1999	Herr et al.	16/412
D436,832 S	*	1/2001	Matsuo et al.	D8/313
D442,846 S	*	5/2001	Bastian	D8/313

* cited by examiner

Primary Examiner—Adir Aronovich

(74) *Attorney, Agent, or Firm*—Pearne & Gordon LLP

(57) **CLAIM**

The ornamental design for a recessed handle with lid, as shown and described.

DESCRIPTION

FIG. 1 is a perspective view of my new design for a recessed handle with lid;

FIG. 2 is a top view of FIG. 1;

FIG. 3 is a front view of FIG. 1;

FIG. 4 is a right side view of FIG. 1;

FIG. 5 is a left side view of FIG. 1;

FIG. 6 is a bottom view of FIG. 1;

FIG. 7 is a back view of FIG. 1;

FIG. 8 is a perspective view of the recessed handle with lid of FIG. 1 showing the lid in an open position;

FIG. 9 is a top view of FIG. 8;

FIG. 10 is a front view of FIG. 8;

FIG. 11 is a right side view of FIG. 8;

FIG. 12 is a left side view of FIG. 8;

FIG. 13 is a bottom view of FIG. 8; and,

FIG. 14 is a back view of FIG. 8.

The broken line boundary shown in FIGS. 1, 2, 8 and 9 is for illustrative purposes and forms no part of the claimed design.

1 Claim, 8 Drawing Sheets

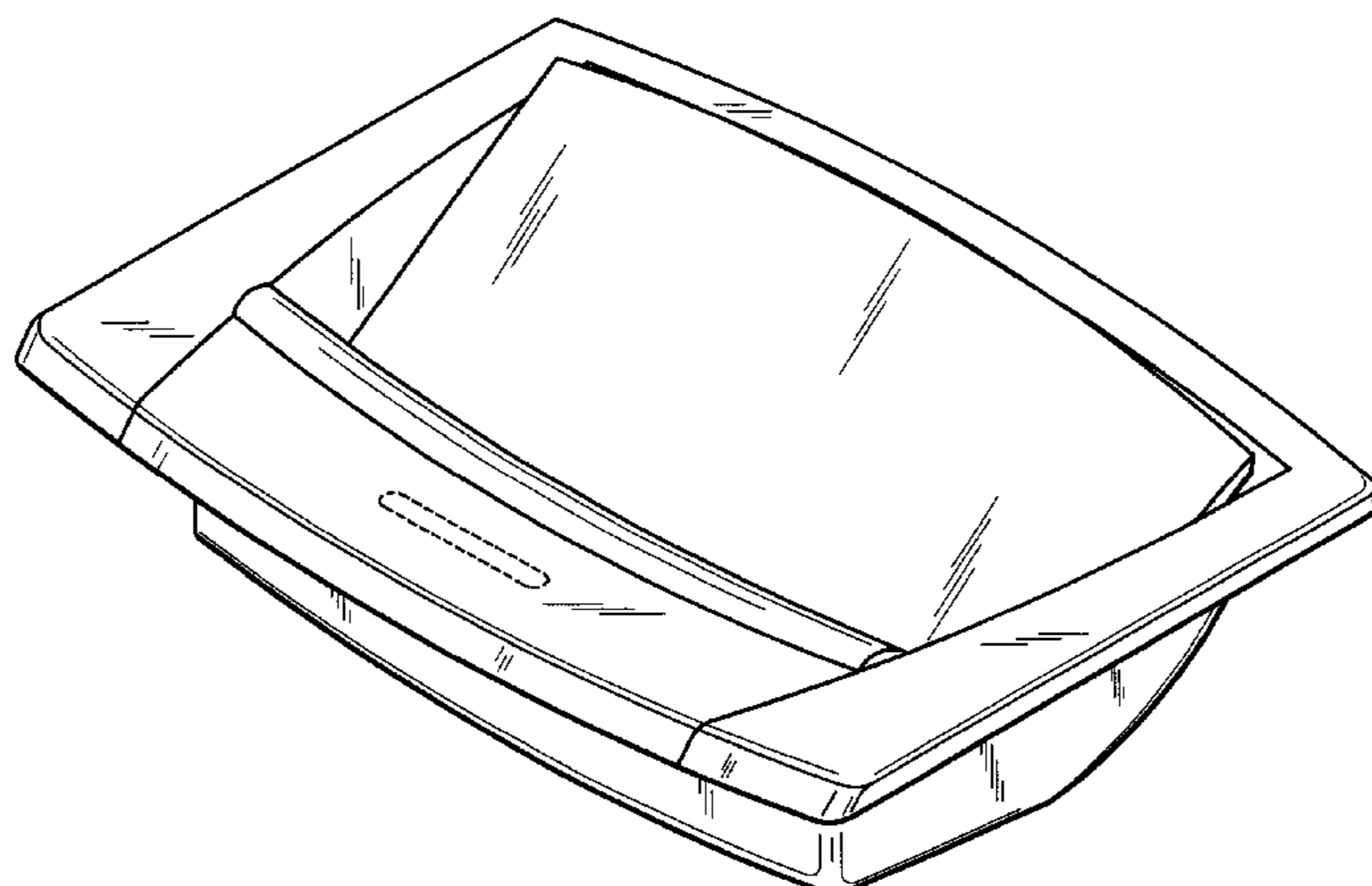
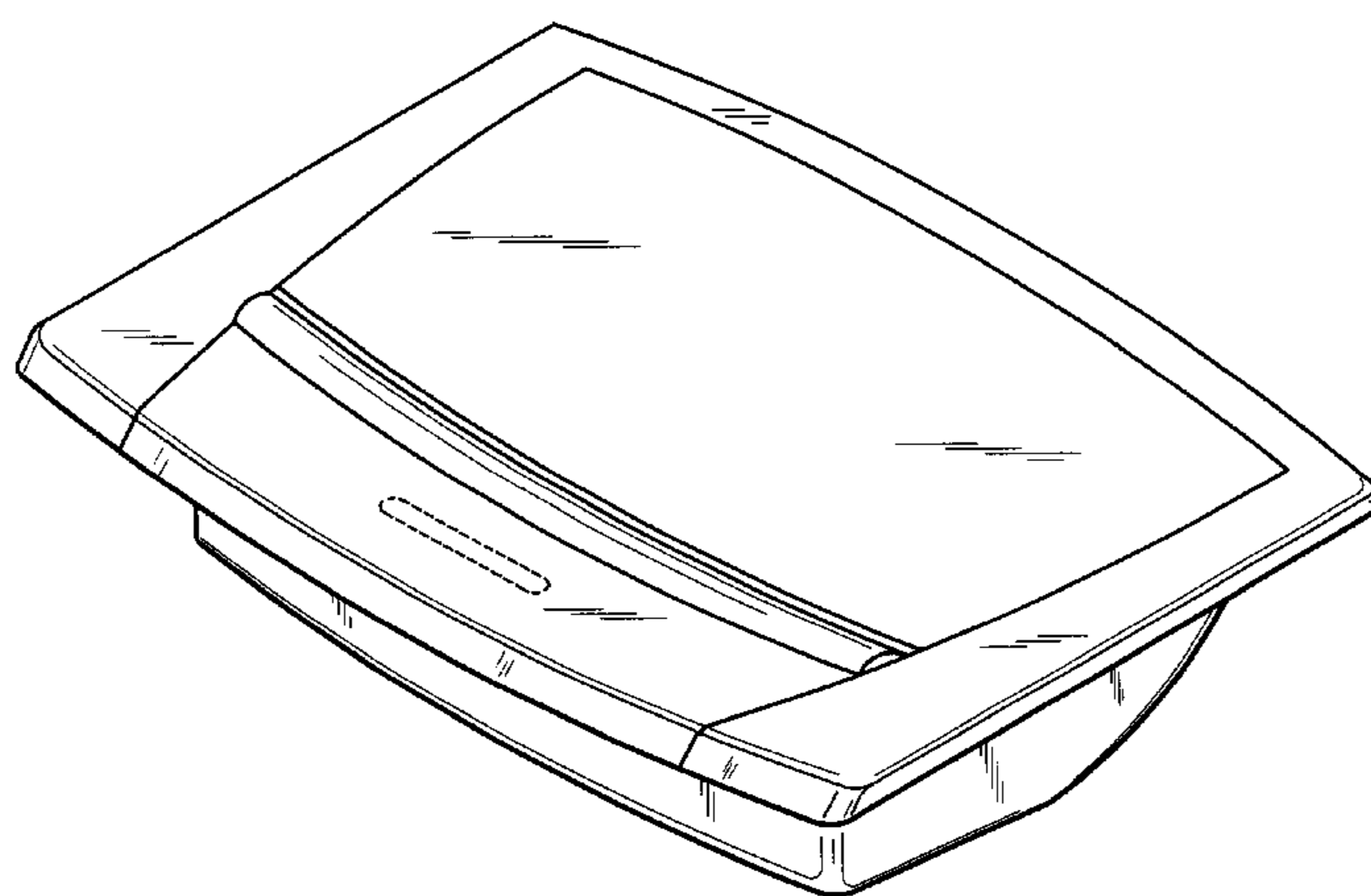

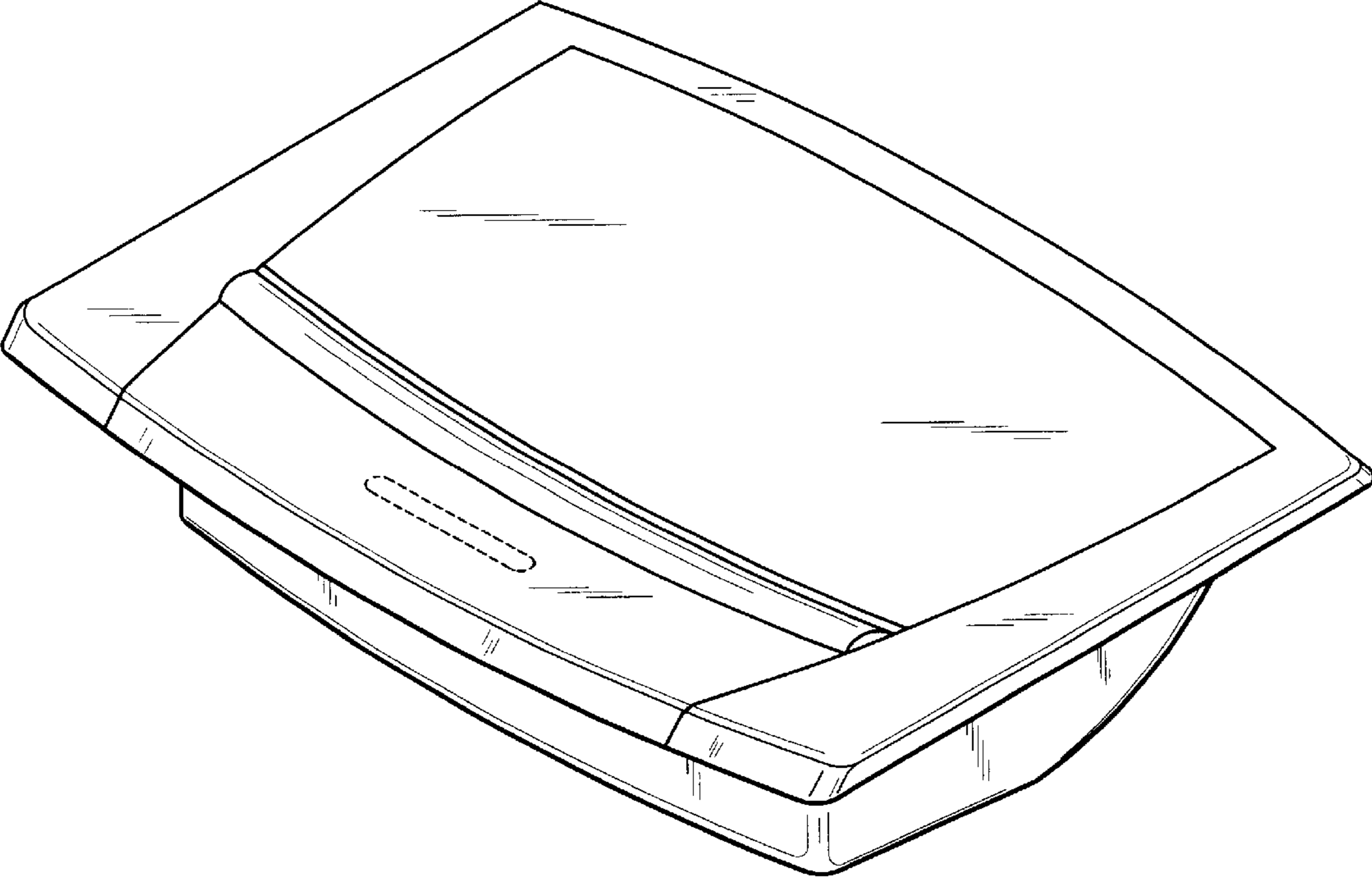

FIG. 1

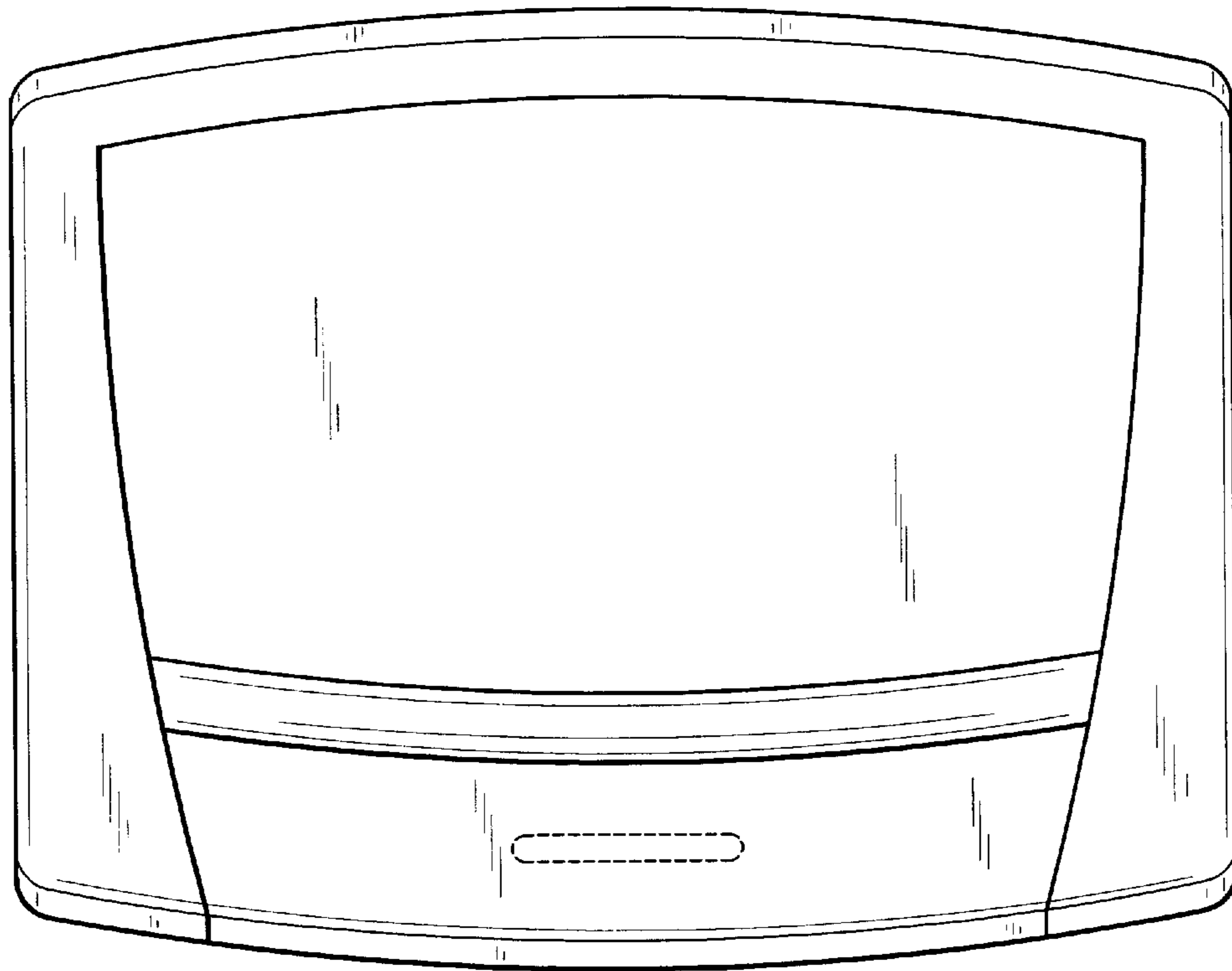

FIG. 2

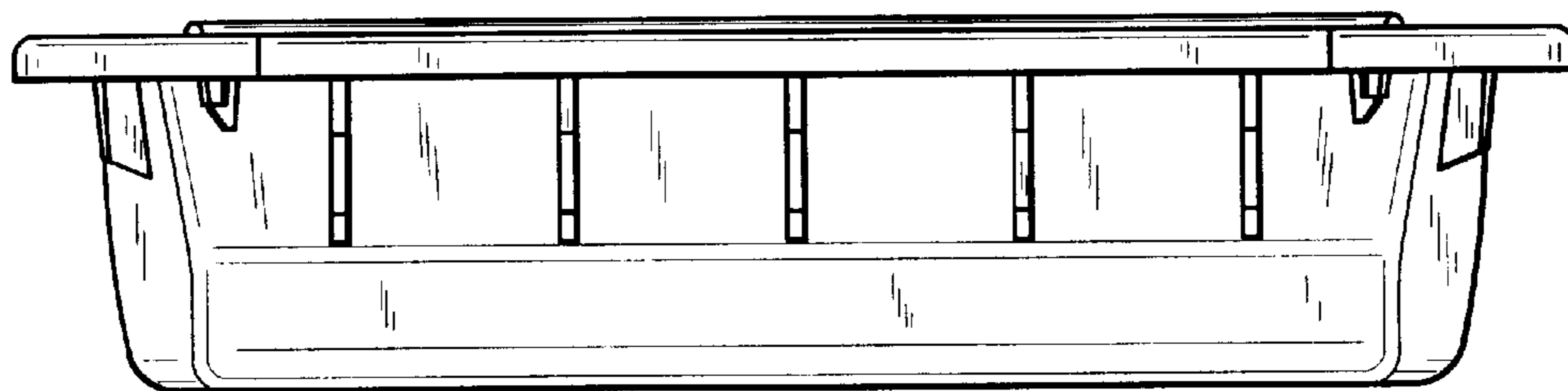

FIG. 3

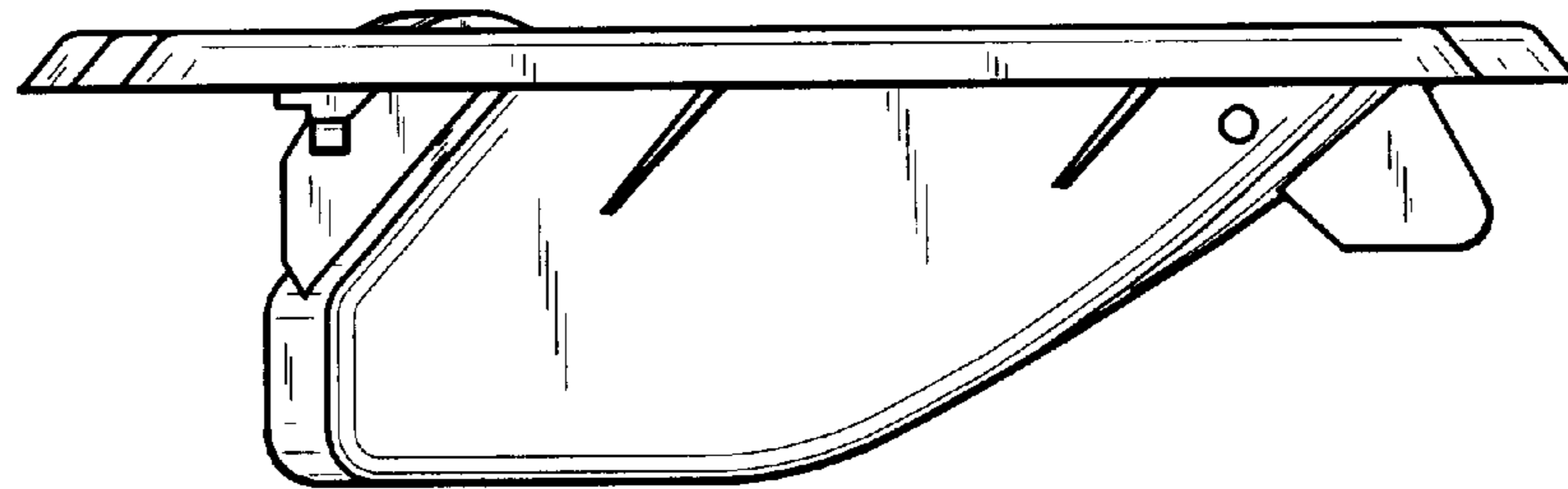

FIG. 4

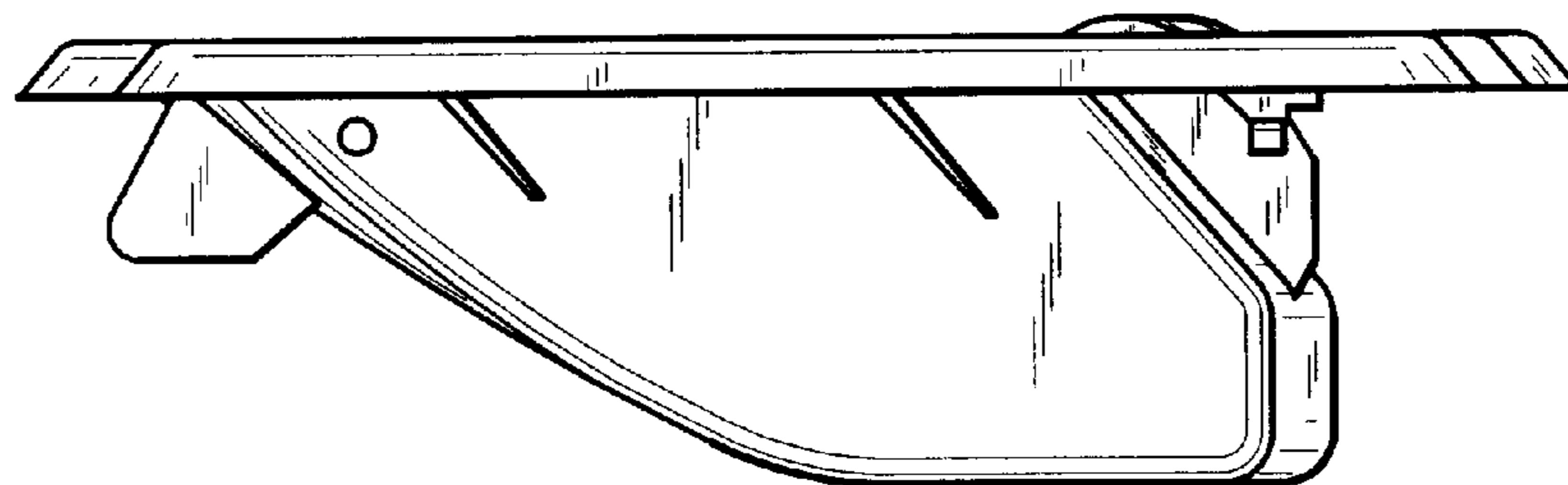

FIG. 5

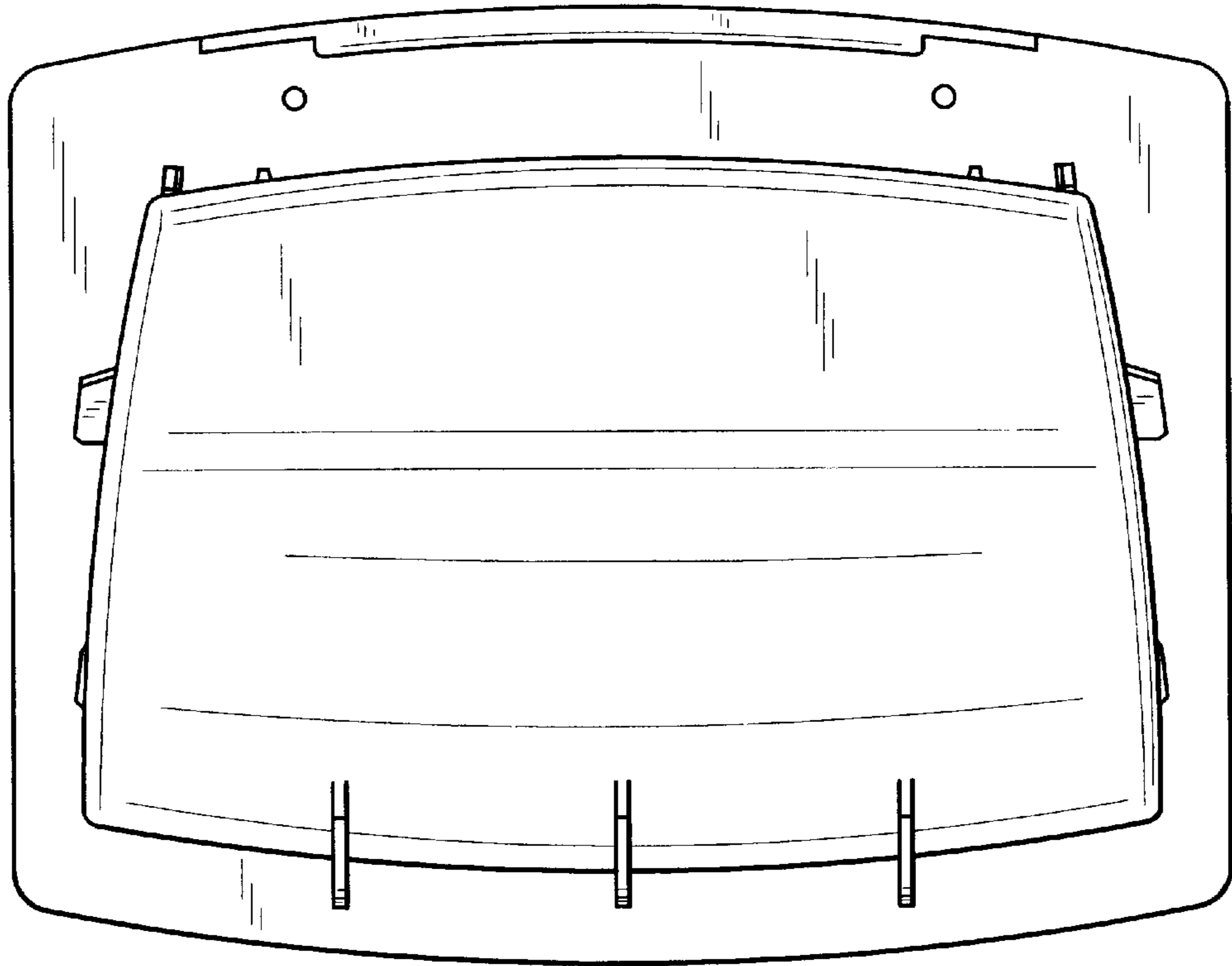

FIG. 6

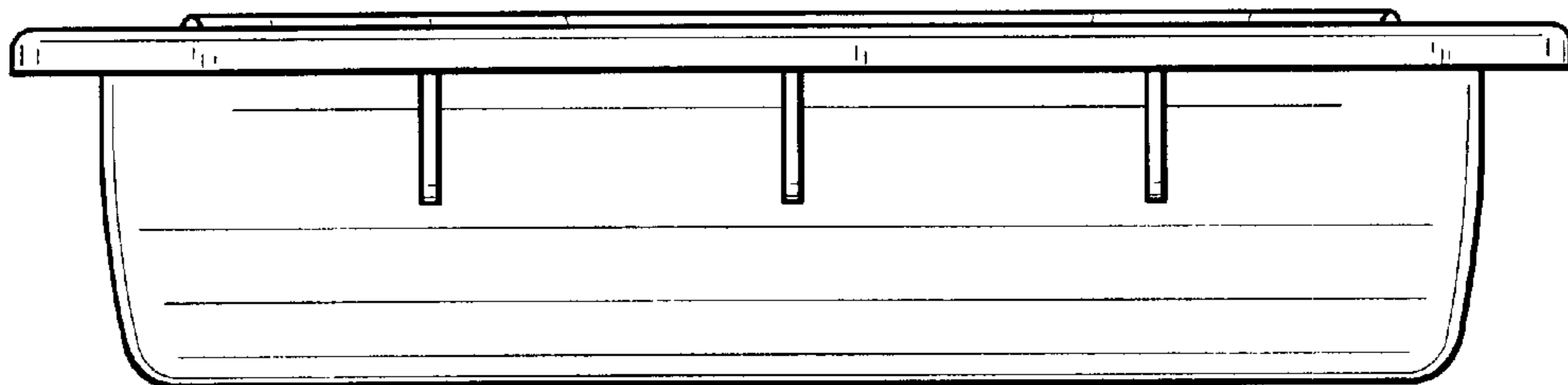

FIG. 7

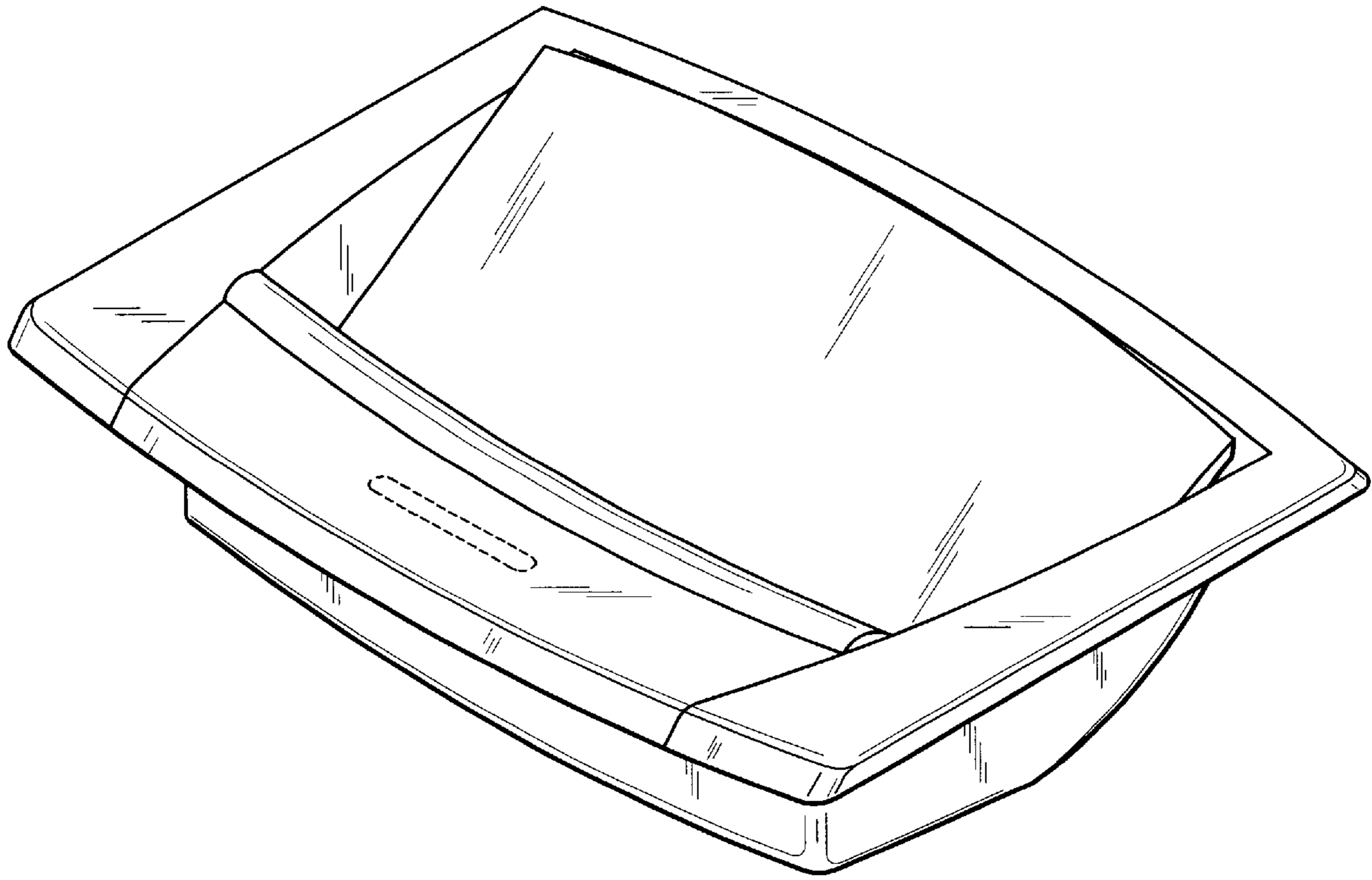

FIG. 8

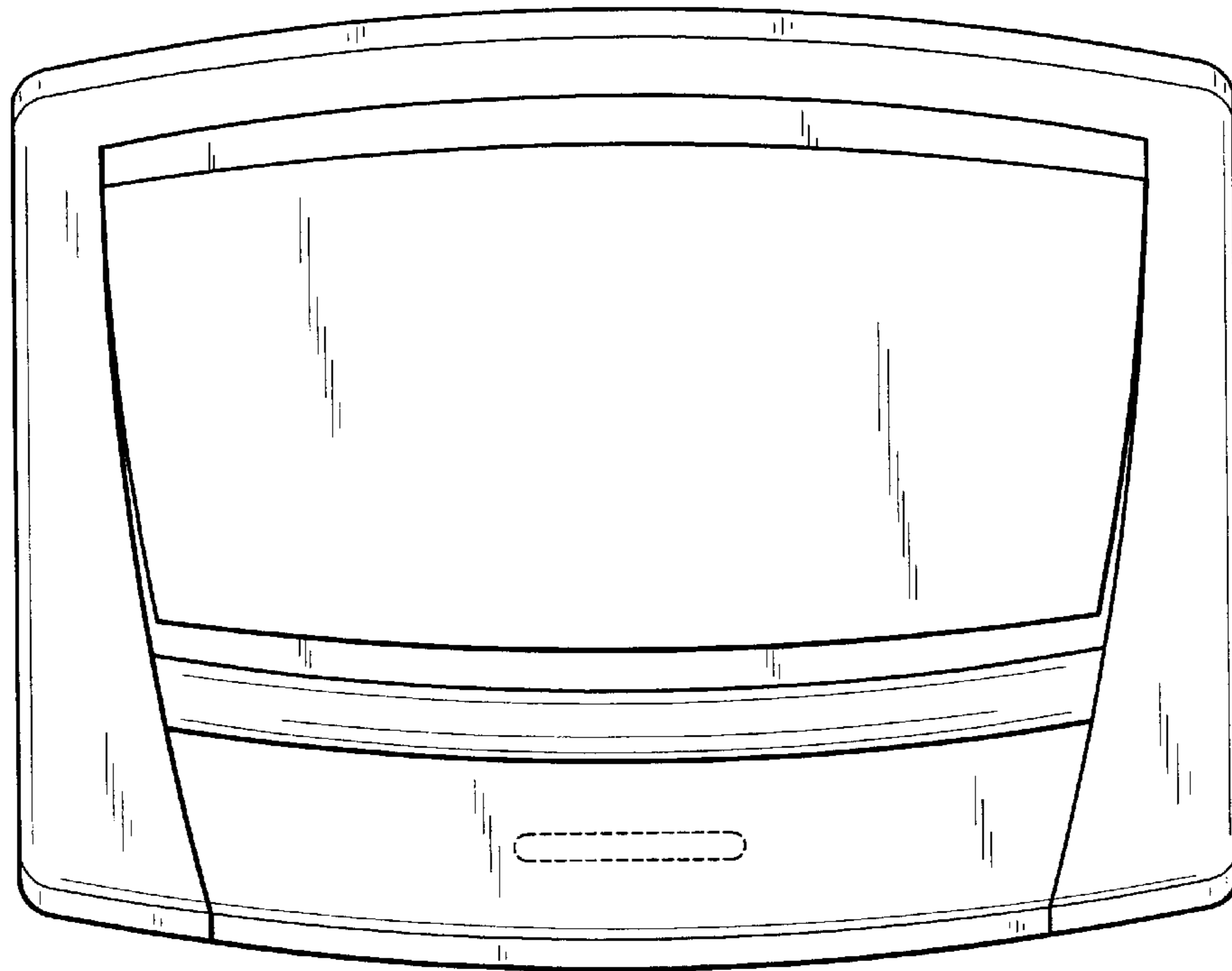

FIG. 9

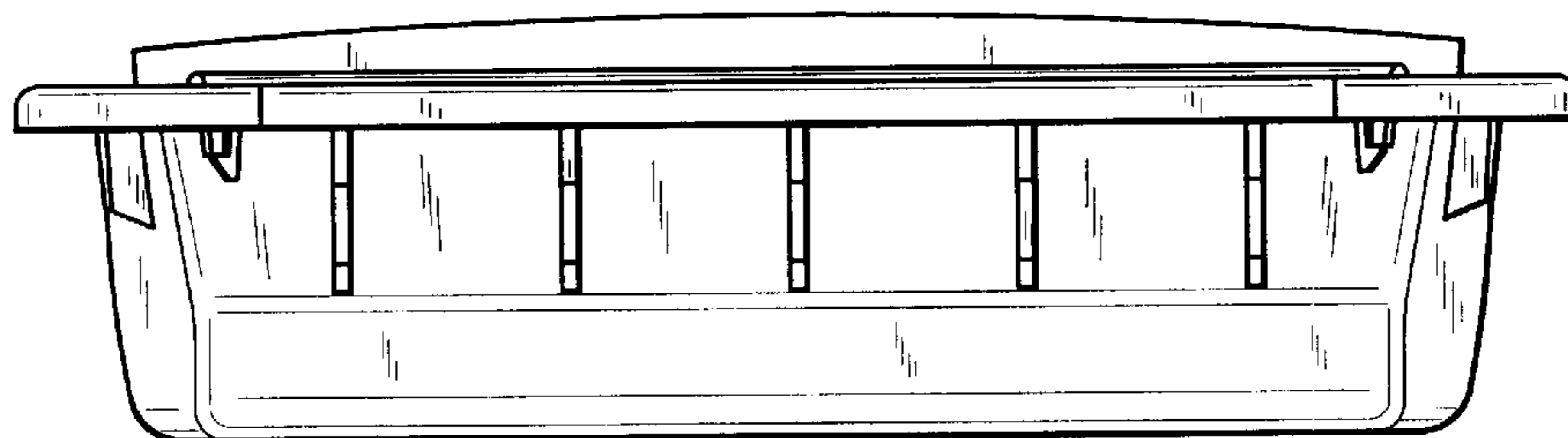

FIG. 10

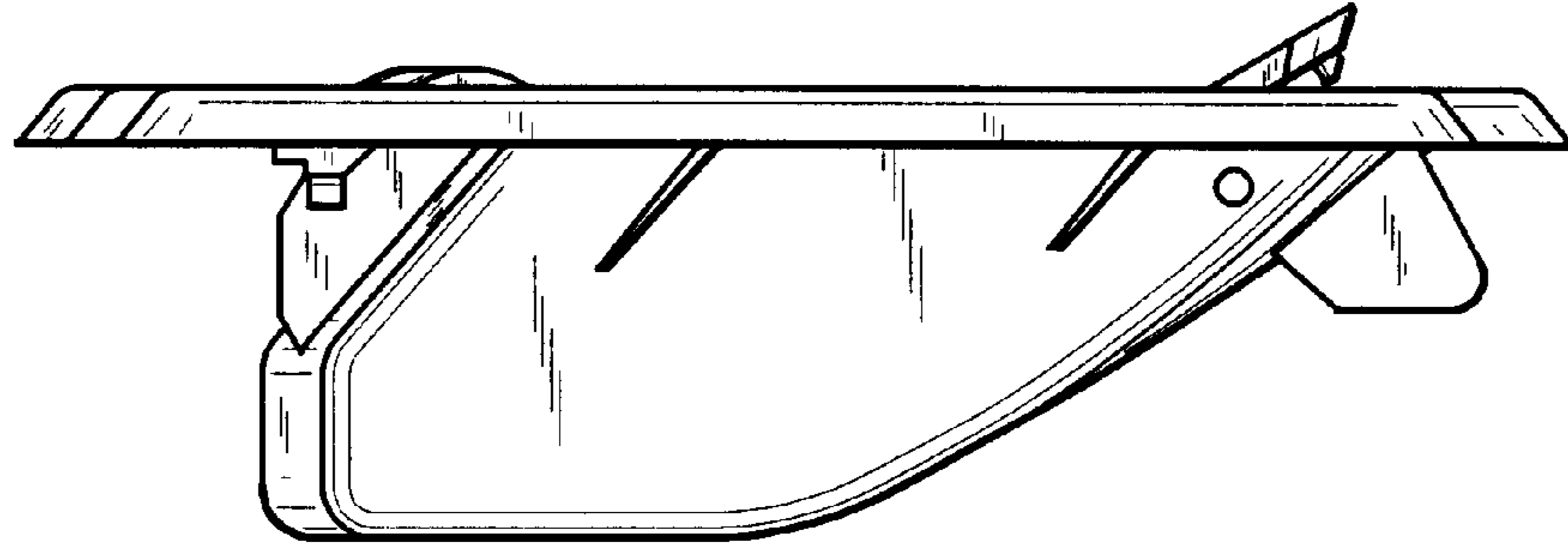

FIG. 1 1

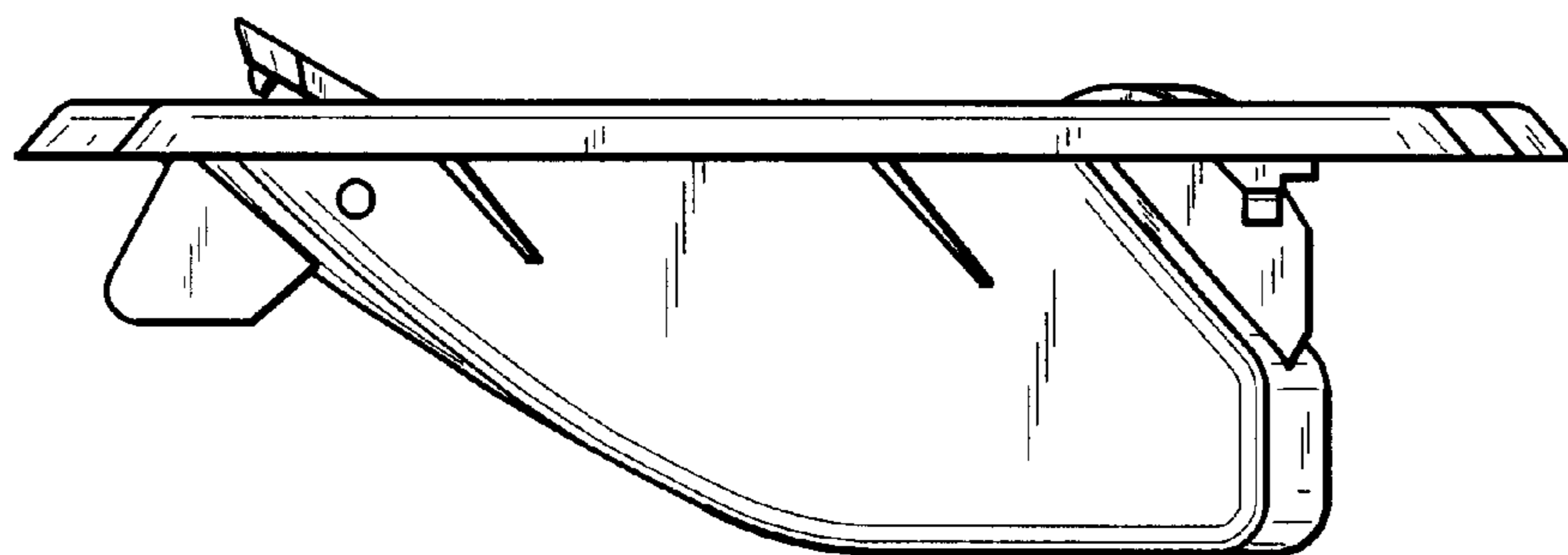

FIG. 1 2

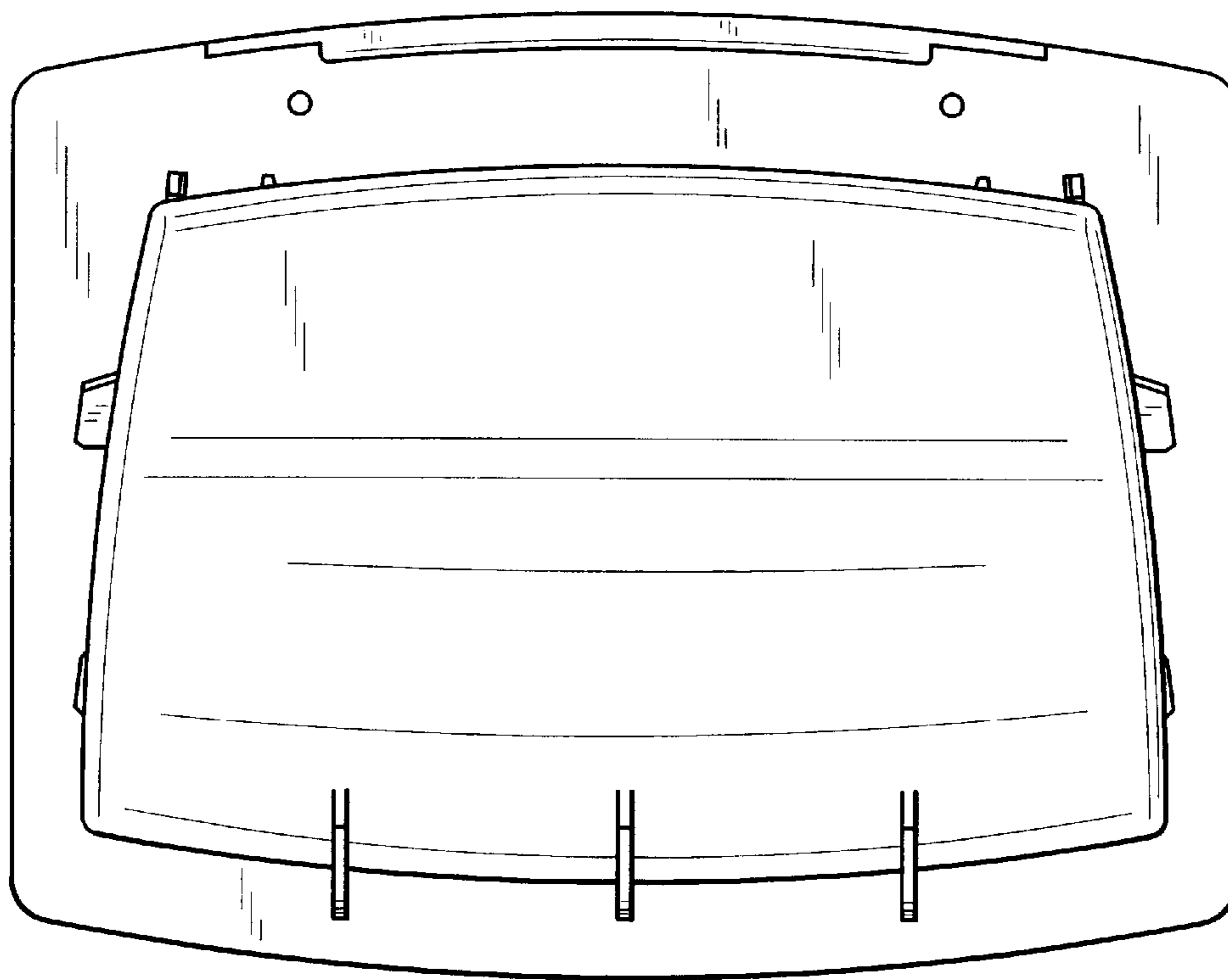

FIG. 13

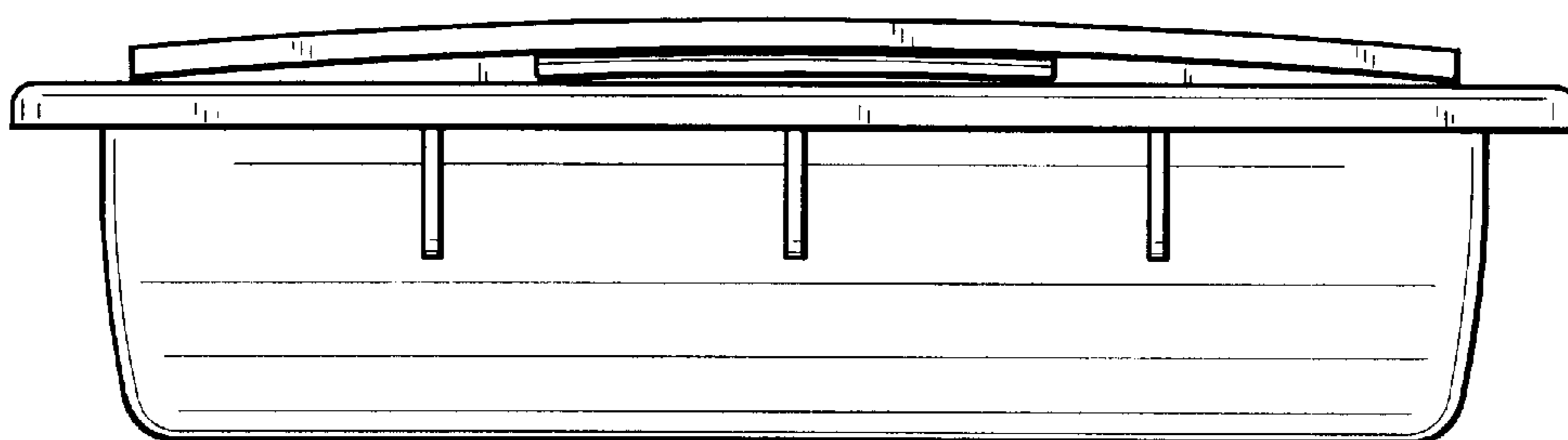

FIG. 14

UNITED STATES PATENT AND TRADEMARK OFFICE
CERTIFICATE OF CORRECTION

PATENT NO. : Des. 494,836 S
DATED : August 24, 2004
INVENTOR(S) : Alberto Bertani

Page 1 of 1

It is certified that error appears in the above-identified patent and that said Letters Patent is hereby corrected as shown below:

Title page.

Insert Item: -- [30] **Foreign Application Priority Data**

Aug. 9, 2002 International DesignDM/060982 --.

Signed and Sealed this

Twenty-fourth Day of January, 2006

A handwritten signature in black ink on a light gray dotted background. The signature reads "Jon W. Dudas" in a cursive, stylized script.

JON W. DUDAS

Director of the United States Patent and Trademark Office