



US00D494761S1

(12) **United States Design Patent**
Gray

(10) **Patent No.:** **US D494,761 S**

(45) **Date of Patent:** **** Aug. 24, 2004**

(54) **GOLF BAG CARRIER**

D422,791 S * 4/2000 Han D3/320

(76) **Inventor:** **Daniel S. Gray**, 600 Poppy Ave.,
Patterson, CA (US) 95363

* cited by examiner

Primary Examiner—Catherine R. Oliver

(74) *Attorney, Agent, or Firm*—Francis Law Group

(**) **Term:** **14 Years**

(57) **CLAIM**

(21) **Appl. No.:** **29/177,766**

I claim the ornamental design for a golf bag carrier, as shown and described.

(22) **Filed:** **Mar. 13, 2003**

(51) **LOC (7) Cl.** **03-01**

DESCRIPTION

(52) **U.S. Cl.** **D3/320; D3/255**

FIG. 1 is a perspective view of my new design;

(58) **Field of Search** D3/320, 255, 254,

FIG. 2 is a top plan view thereof;

D3/259; 206/315.2, 315.3, 315.4, 315.5,

FIG. 3 the left side elevational view thereof;

316.6, 315.7, 315.8; 211/20.2; 248/95, 96

FIG. 4 is a right side elevational view thereof;

FIG. 5 is a front elevational view thereof;

FIG. 6 is a rear elevational view; and,

FIG. 7 is a bottom plan view thereof.

(56) **References Cited**

U.S. PATENT DOCUMENTS

D372,362 S * 8/1996 Bryant et al. D3/320

D389,650 S * 1/1998 Rhee D3/320

1 Claim, 4 Drawing Sheets

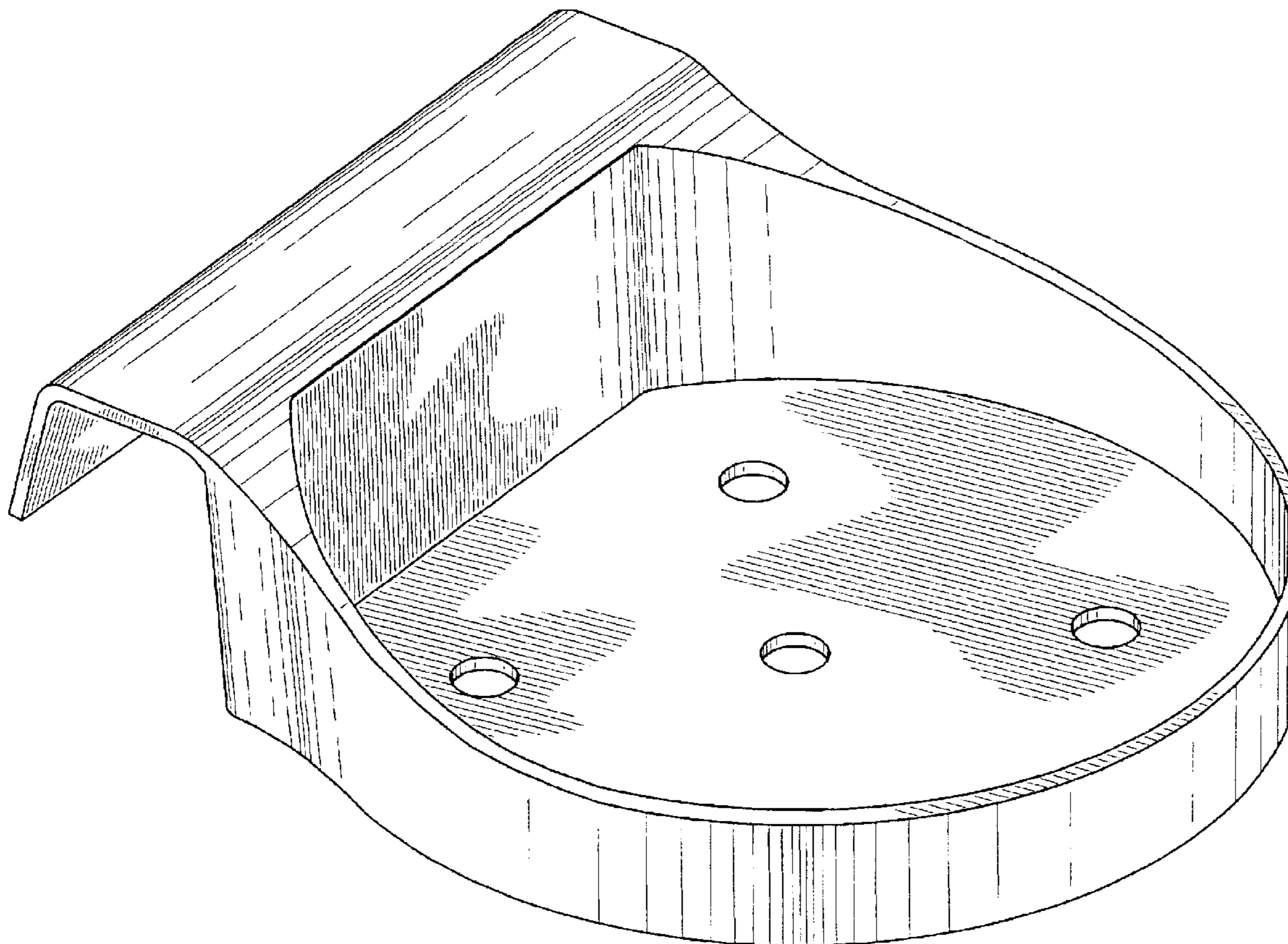

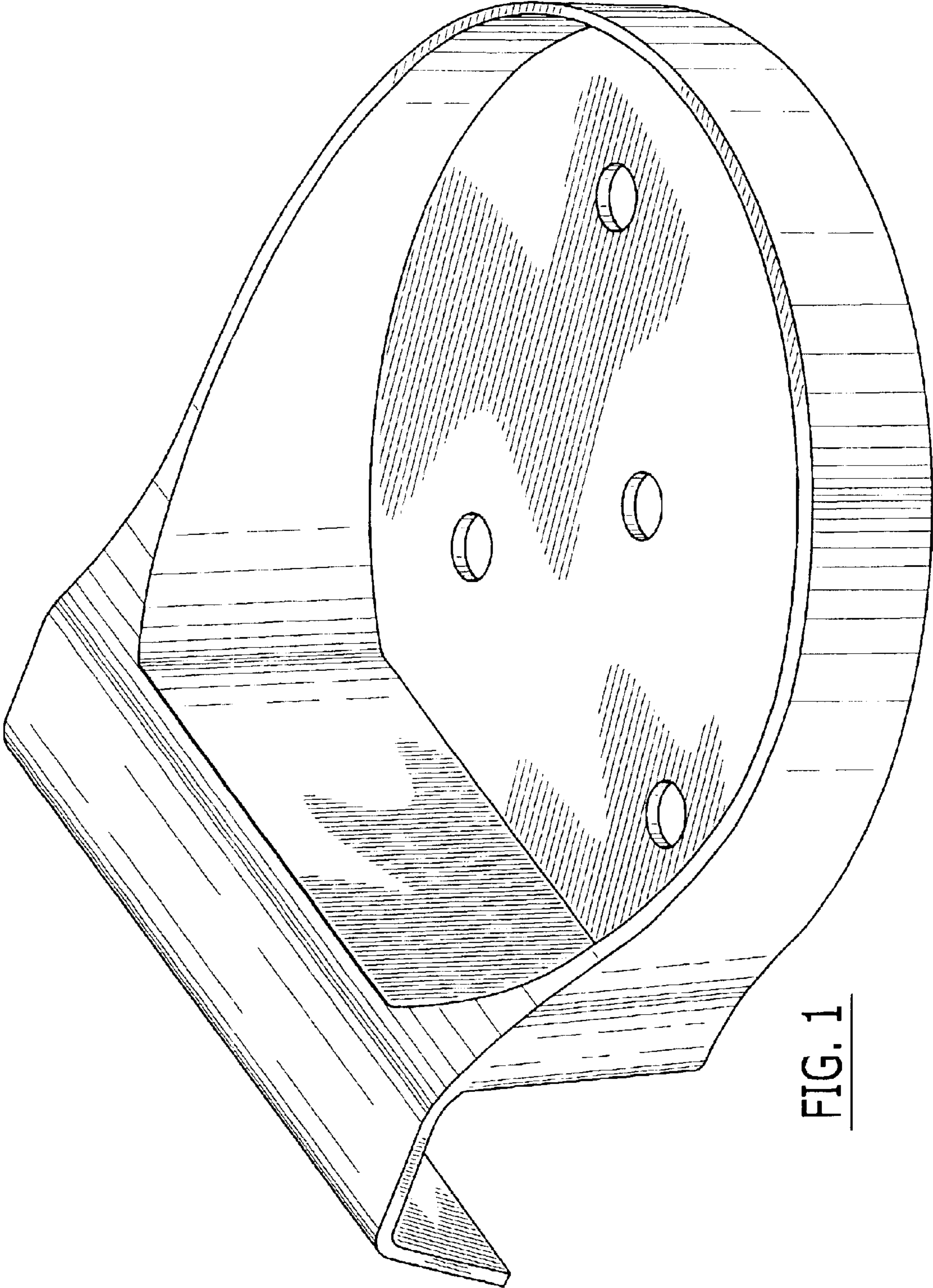

FIG. 1

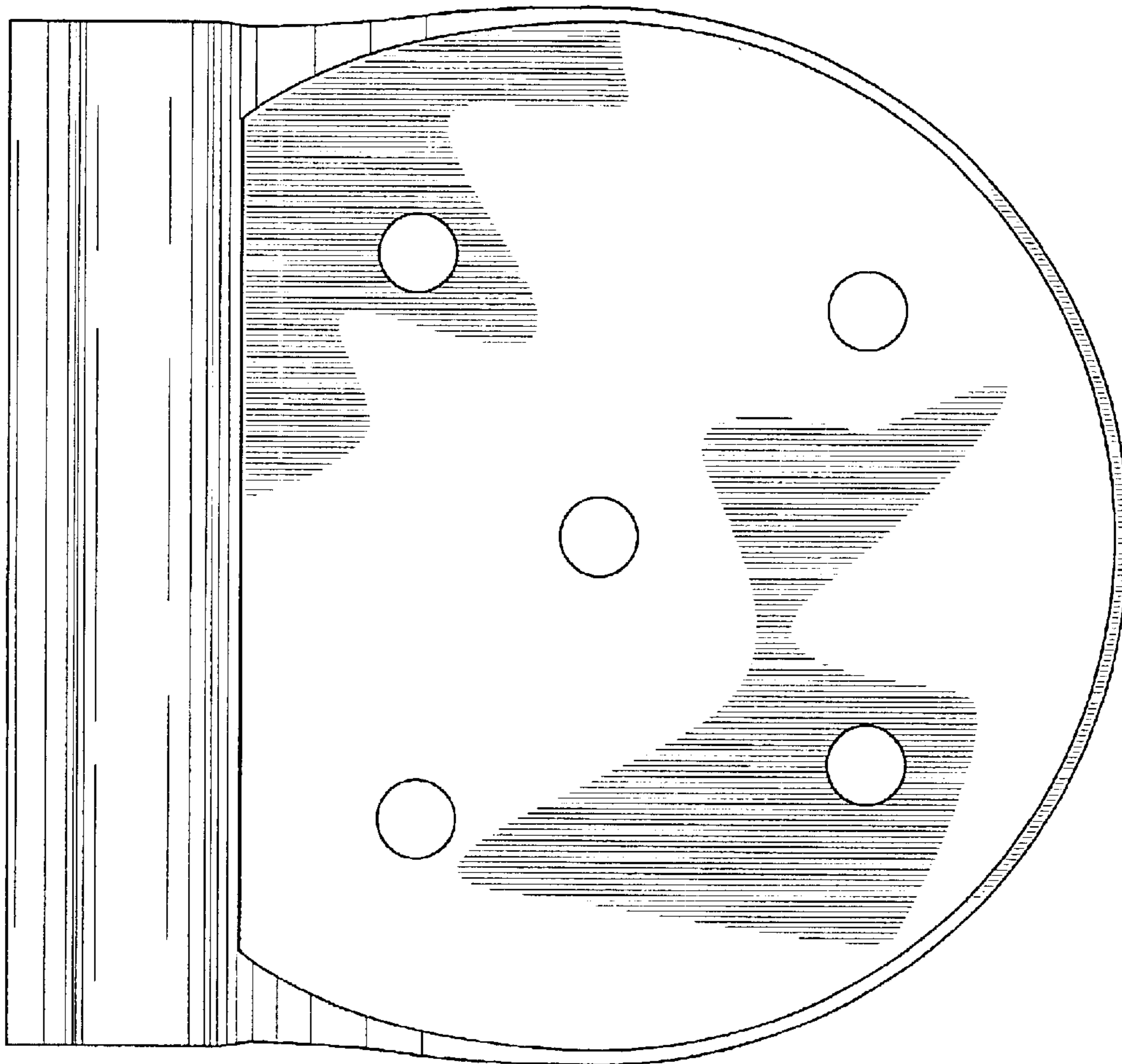

FIG. 2

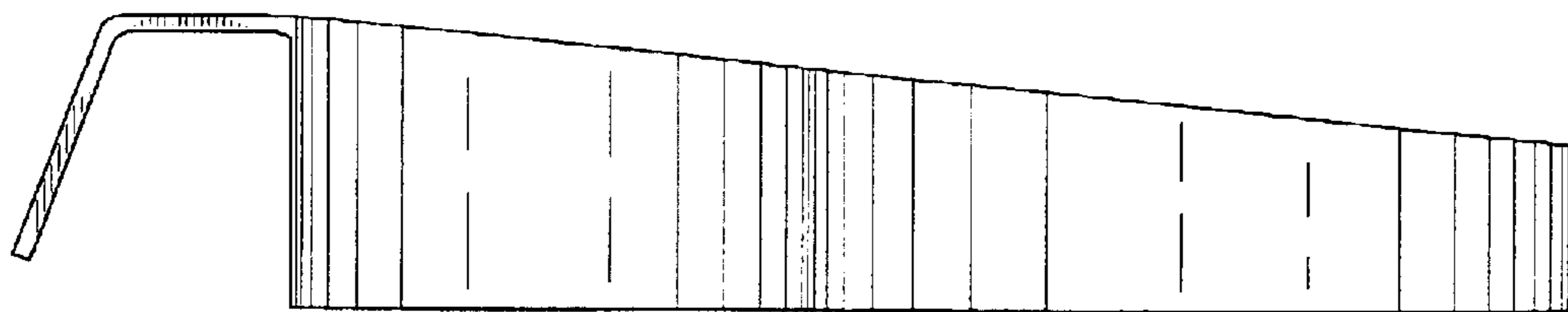

FIG. 3

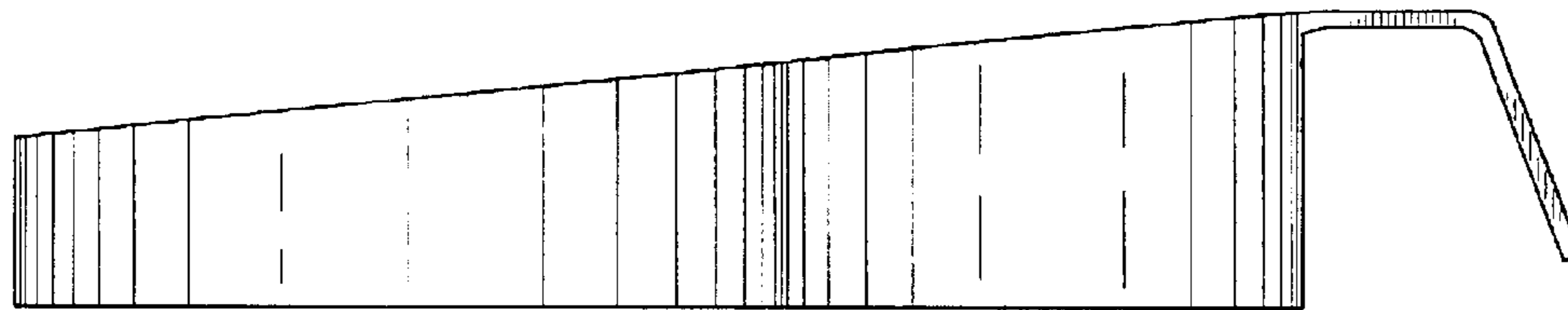

FIG. 4

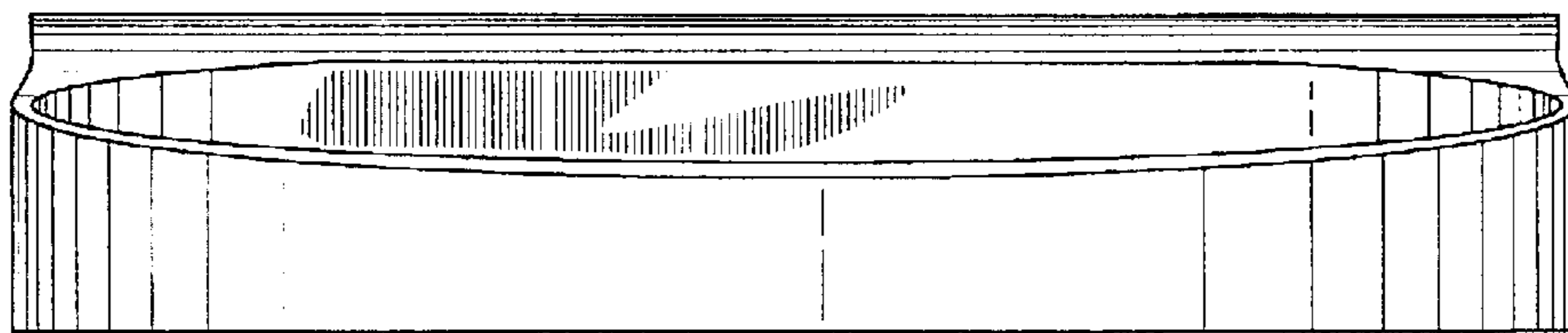

FIG. 5

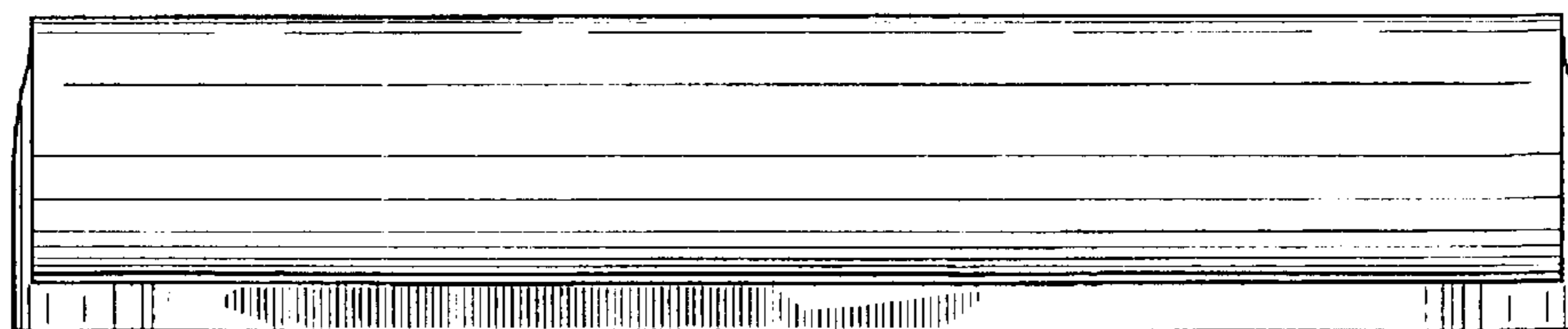

FIG. 6

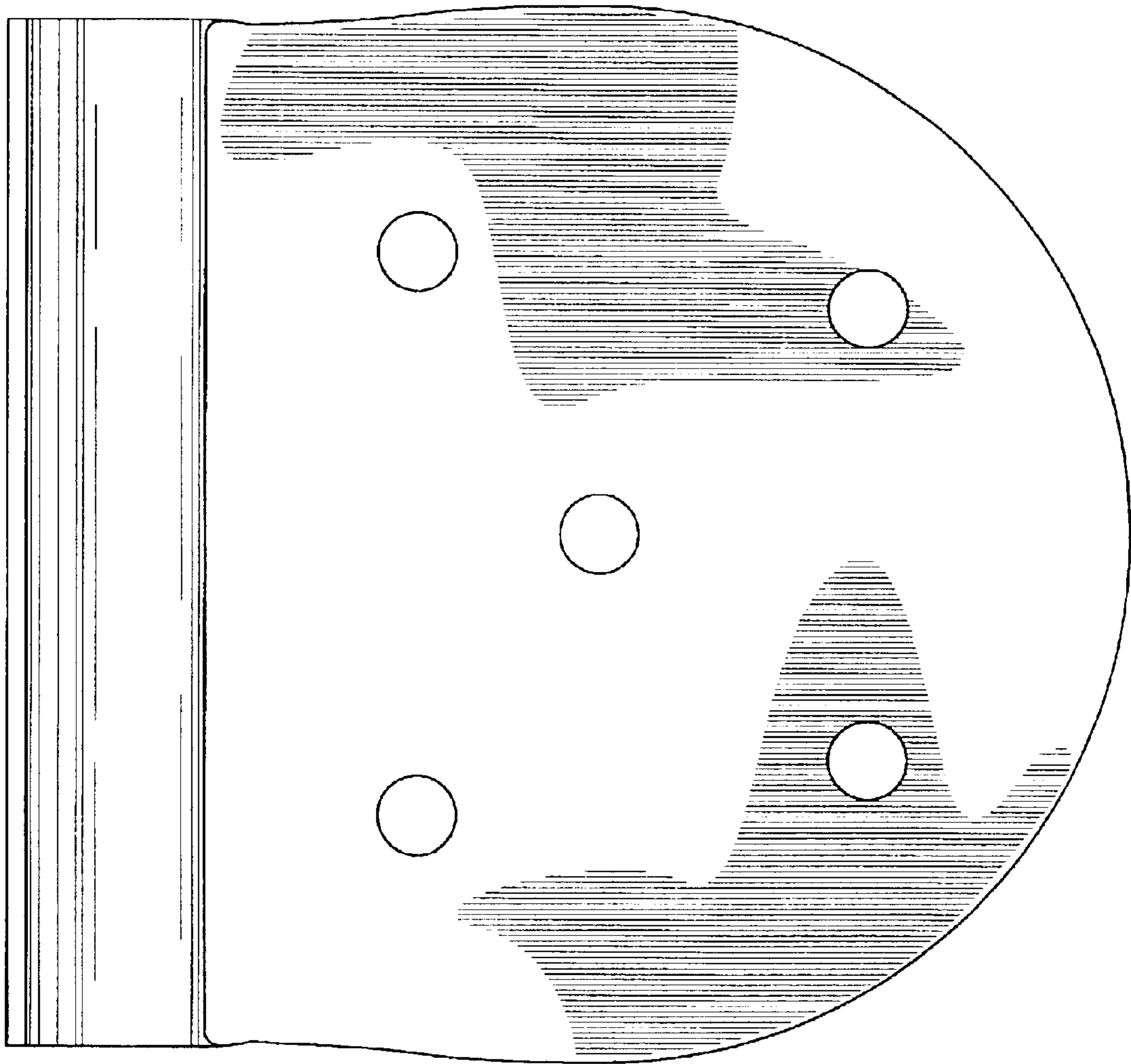

FIG. 7